



US00D962190S

(12) **United States Design Patent** (10) **Patent No.:** **US D962,190 S**  
**Du et al.** (45) **Date of Patent:** **\*\* Aug. 30, 2022**

(54) **SPEAKERPHONE**

(71) Applicant: **Dell Products L.P.**, Round Rock, TX (US)

(72) Inventors: **Hang Du**, Singapore (SG); **Suet Chan Law**, Singapore (SG); **Sok Hui Khoo**, Singapore (SG)

(73) Assignee: **Dell Products L.P.**, Round Rock, TX (US)

(\*\*) Term: **15 Years**

(21) Appl. No.: **29/814,106**

(22) Filed: **Nov. 3, 2021**

(51) **LOC (13) Cl.** ..... **14-03**

(52) **U.S. Cl.**  
USPC ..... **D14/149**; D14/172

(58) **Field of Classification Search**  
USPC ..... D14/140, 142, 144, 149, 150, 496, 299, D14/204, 226, 172, 215, 216, 221, 228, D14/211, 358, 155; D10/104.1, 106.1, D10/106.3, 106.5; D24/185, 186  
CPC ..... H04M 1/00; H04M 1/026; H04M 1/04; H04M 1/6033; H04M 1/6041; H04M 1/62; H04M 3/02; H04M 3/005; H04M 3/56; H04M 3/564; H04M 3/568; H04M 9/08; H04R 1/00; H04R 1/02; H04R 1/403; H04R 1/406; H04R 27/00  
See application file for complete search history.

(56) **References Cited**

**U.S. PATENT DOCUMENTS**

D485,825 S *	1/2004	Yoneda	.....	D14/215
D526,990 S *	8/2006	Slevin	.....	D14/149
D537,071 S *	2/2007	Chen	.....	D14/215
D554,630 S *	11/2007	Ma	.....	D14/240
D554,631 S *	11/2007	Ma	.....	D14/240
D582,392 S *	12/2008	Pauschitz	.....	D14/215

D598,006 S *	8/2009	Tse	.....	D14/209.1
D614,200 S *	4/2010	Skurdal	.....	D14/496
D618,252 S *	6/2010	Bradford	.....	D14/203.1
D641,729 S *	7/2011	Hao	.....	D14/215
D644,200 S *	8/2011	Bolton	.....	D14/209.1
D644,626 S *	9/2011	Bolton	.....	D14/209.1
D647,505 S *	10/2011	Skurdal	.....	D14/209.1
D648,743 S *	11/2011	Chang	.....	D14/188
D655,249 S *	3/2012	Dublin	.....	D13/154
D659,670 S *	5/2012	Goetzen	.....	D14/194
D661,286 S *	6/2012	McManigal	.....	D14/240
D661,686 S *	6/2012	Bolton	.....	D14/209.1
D672,715 S *	12/2012	Brunner	.....	D13/110
D673,525 S *	1/2013	Goetzen	.....	D14/209.1

(Continued)

**OTHER PUBLICATIONS**

U.S. Appl. No. 29/751,539, filed Sep. 22, 2020, entitled Camera and Speaker Peripheral, by inventors Tanaka et al.

(Continued)

*Primary Examiner* — Marie D. Fast Horse

(74) *Attorney, Agent, or Firm* — Zagorin Cave LLP; Robert W. Holland

(57) **CLAIM**

We claim the ornamental design for a speakerphone, as shown and described.

**DESCRIPTION**

FIG. 1 is a front perspective view of the speakerphone comprising the present invention; FIG. 2 is a front elevation view thereof; FIG. 3 is a rear elevation view thereof; FIG. 4 is a right side view thereof; FIG. 5 is a left side view thereof; FIG. 6 is a top view thereof; and, FIG. 7 is a bottom view thereof. Broken lines shown in the drawings depict portions of the speakerphone that form no part of the claimed design.

**1 Claim, 6 Drawing Sheets**

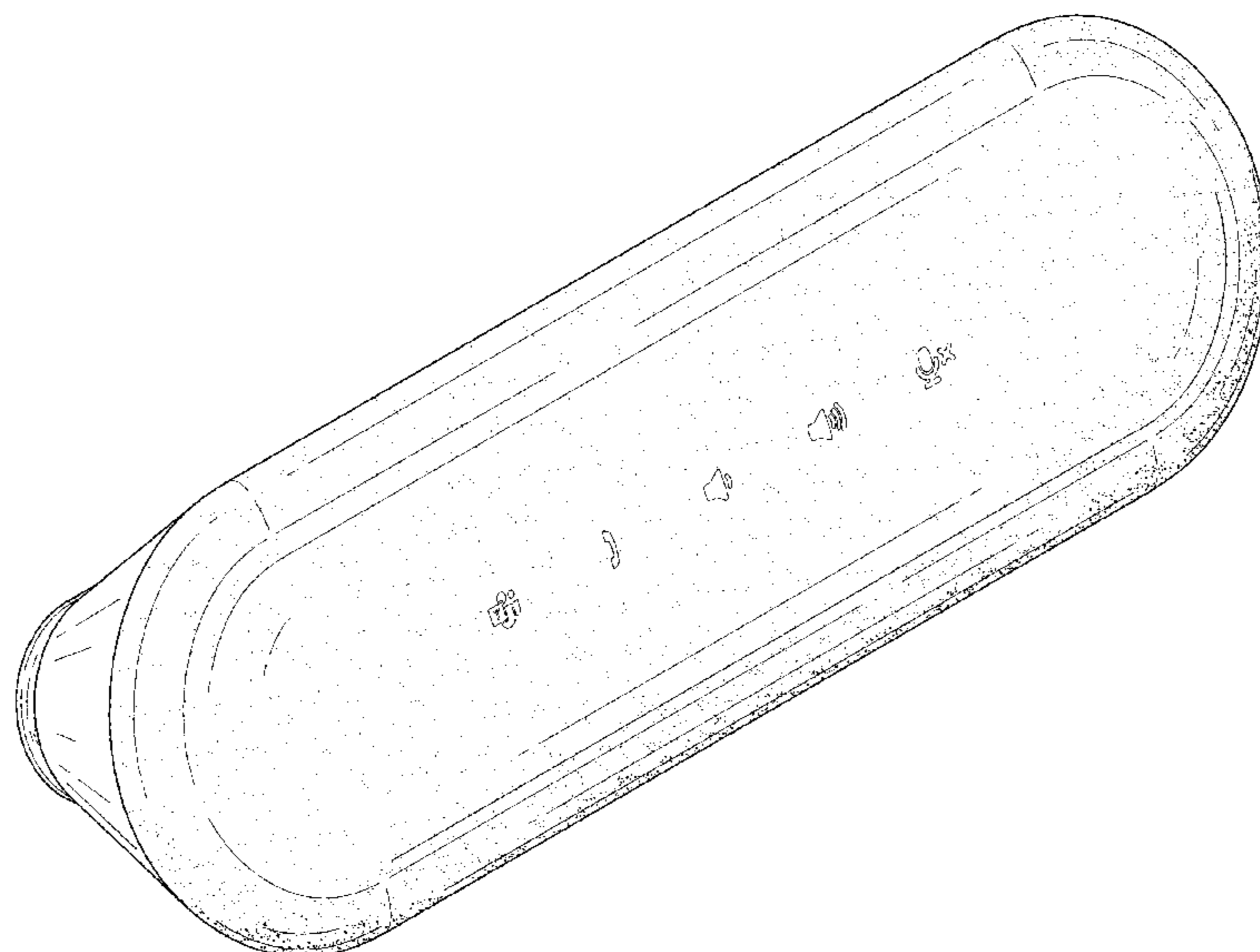

(56)

References Cited

U.S. PATENT DOCUMENTS

D674,774 S \* 1/2013 Bolton ..... D14/204  
 D674,779 S \* 1/2013 Joseph ..... D14/214  
 D677,245 S \* 3/2013 Joseph ..... D14/204  
 D681,005 S \* 4/2013 Bolton ..... D14/209.1  
 D681,010 S \* 4/2013 Cho ..... D14/215  
 D685,348 S \* 7/2013 Szymanski ..... D14/214  
 D687,010 S \* 7/2013 McManigal ..... D14/188  
 D688,228 S \* 8/2013 Ryu ..... D14/209.1  
 D688,229 S \* 8/2013 Ryu ..... D14/209.1  
 D694,653 S \* 12/2013 Hsu ..... D10/15  
 D694,736 S \* 12/2013 Cheng ..... D14/209.1  
 D697,898 S \* 1/2014 Park ..... D14/209.1  
 D704,076 S \* 5/2014 Poandl ..... D10/2  
 D707,627 S \* 6/2014 Brunner ..... D13/110  
 D726,187 S \* 4/2015 Young ..... D14/434  
 D745,861 S \* 12/2015 Kim ..... D14/216  
 D800,095 S \* 10/2017 Yao ..... D14/214  
 D807,318 S \* 1/2018 Folkmann ..... D14/149  
 D812,617 S \* 3/2018 Bai ..... D14/434  
 D819,592 S \* 6/2018 Folkmann ..... D14/149  
 D829,688 S 10/2018 Tanaka et al.  
 D841,504 S \* 2/2019 Alvarado ..... D10/103  
 D843,234 S \* 3/2019 Näslund ..... D10/49  
 D868,869 S \* 12/2019 Hodge ..... H04N 7/181  
 D886,766 S \* 6/2020 Matarese ..... D14/204  
 D905,110 S \* 12/2020 Zhang ..... D14/188

D912,670 S \* 3/2021 Etgar ..... D14/388  
 D918,174 S \* 5/2021 Czaniecki ..... D14/215  
 D920,276 S 5/2021 Law  
 D924,878 S \* 7/2021 Han ..... D14/440  
 D931,902 S \* 9/2021 Moore ..... D14/203.7  
 D939,469 S \* 12/2021 Yin ..... D14/204  
 D941,814 S \* 1/2022 Kim ..... D13/168

OTHER PUBLICATIONS

Jabra, “Jabra Speakerphones,” downloaded from <https://www.jabra.com/business/shop-for-business/meeting-rooms#?pfs=title-asc&pfp=1> on Nov. 2, 2021, 6 pages.  
 Dell, “Dell Mobile Adapter Speakerphone—MH3021P | Dell USA,” downloaded from <https://www.dell.com/en-us/work/shop/dell-mobile-adapter-speakerphone-mh3021p/apd/470-aely/pc-accessories> on Nov. 2, 2021, 12 pages.  
 Dell, “Dell Pro Stereo Soundbar—AE515M (Skype for Business certified) | Dell USA,” downloaded from [https://www.dell.com/en-us/work/shop/accessories/apd/520-aaor?gacd=9646510-1026-5761040-266731581-0&dgc=st&ds\\_k=DYNAMIC+SEARCH+ADS&gclsrc=aw.ds&ds\\_rl=1282789&gclid=EAla1QobChMlj\\_fipZH68wlVvsmUCR3DRQnJEAAAYASAAEglMufD\\_BwE](https://www.dell.com/en-us/work/shop/accessories/apd/520-aaor?gacd=9646510-1026-5761040-266731581-0&dgc=st&ds_k=DYNAMIC+SEARCH+ADS&gclsrc=aw.ds&ds_rl=1282789&gclid=EAla1QobChMlj_fipZH68wlVvsmUCR3DRQnJEAAAYASAAEglMufD_BwE) on Nov. 2, 2021, 9 pages.  
 Poly, “Sync 40 | Poly, formerly Plantronics & Polycom,” downloaded from <https://www.poly.com/us/en/products/phones/sync/sync-40> on Nov. 2, 2021, 7 pages.

\* cited by examiner

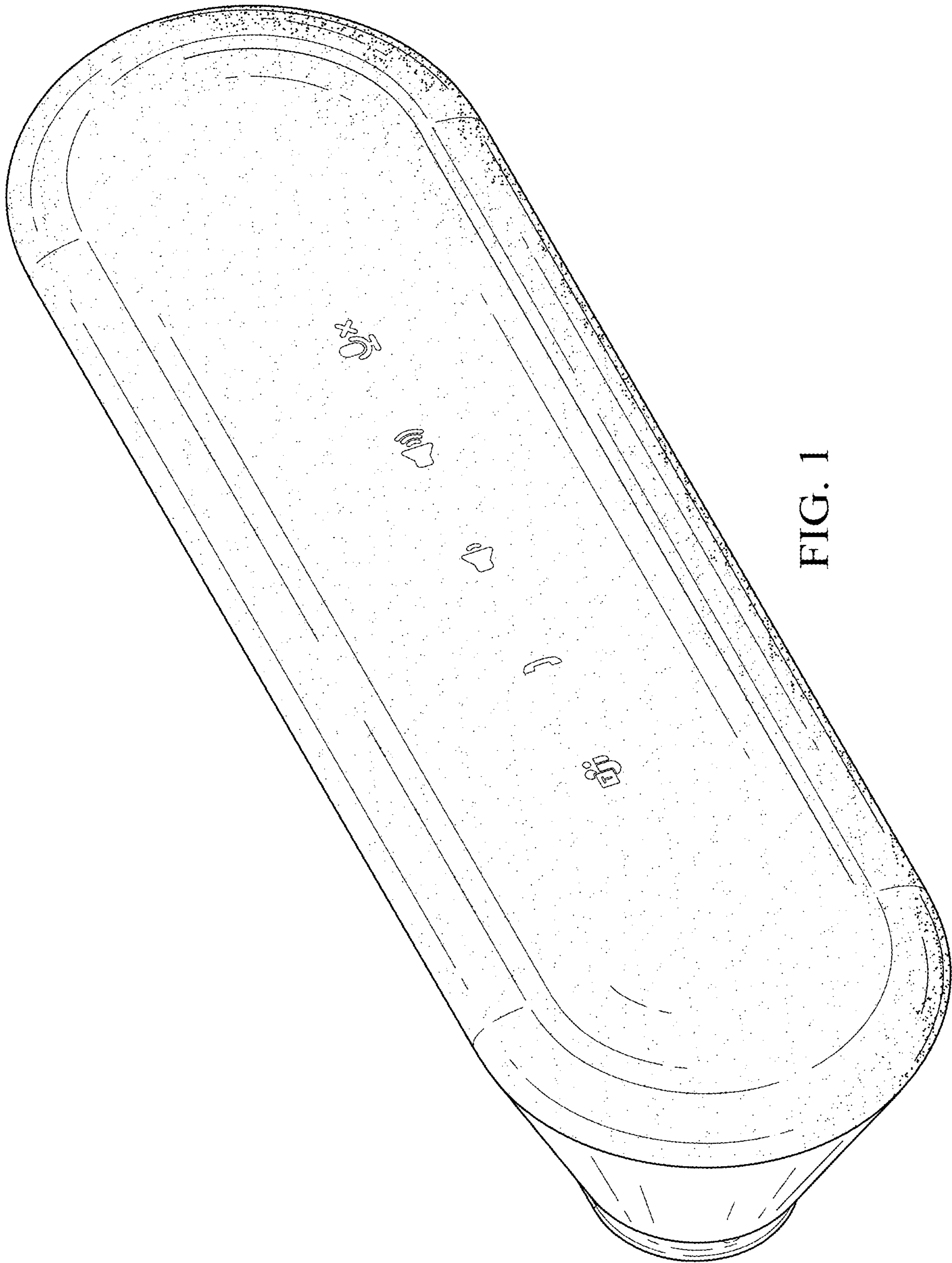

FIG. 1



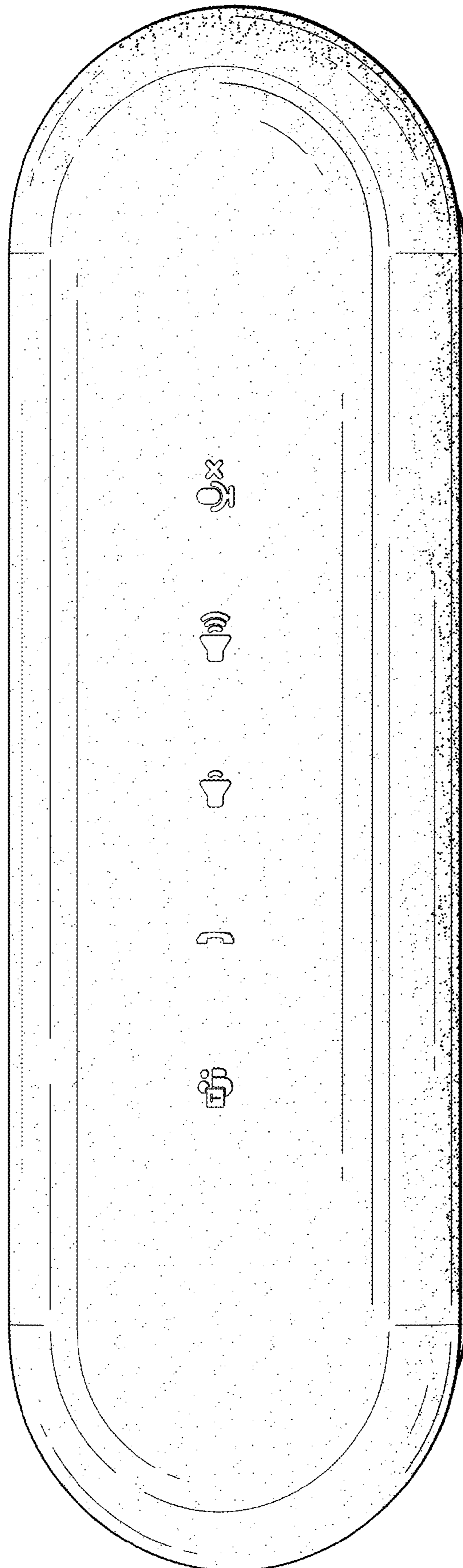

FIG. 2

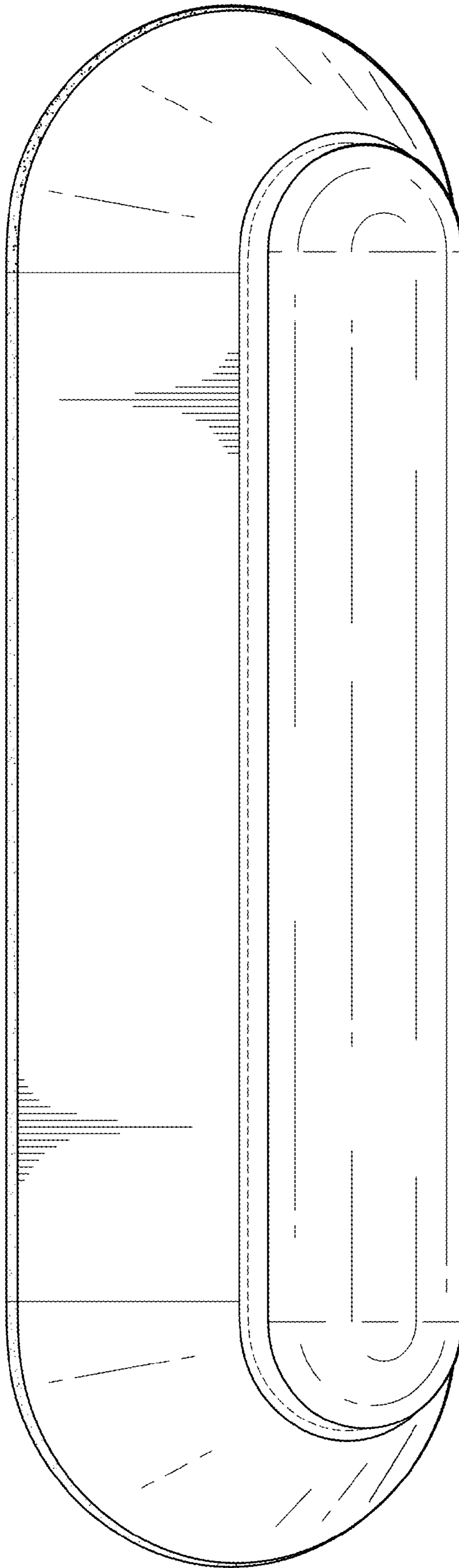

FIG. 3

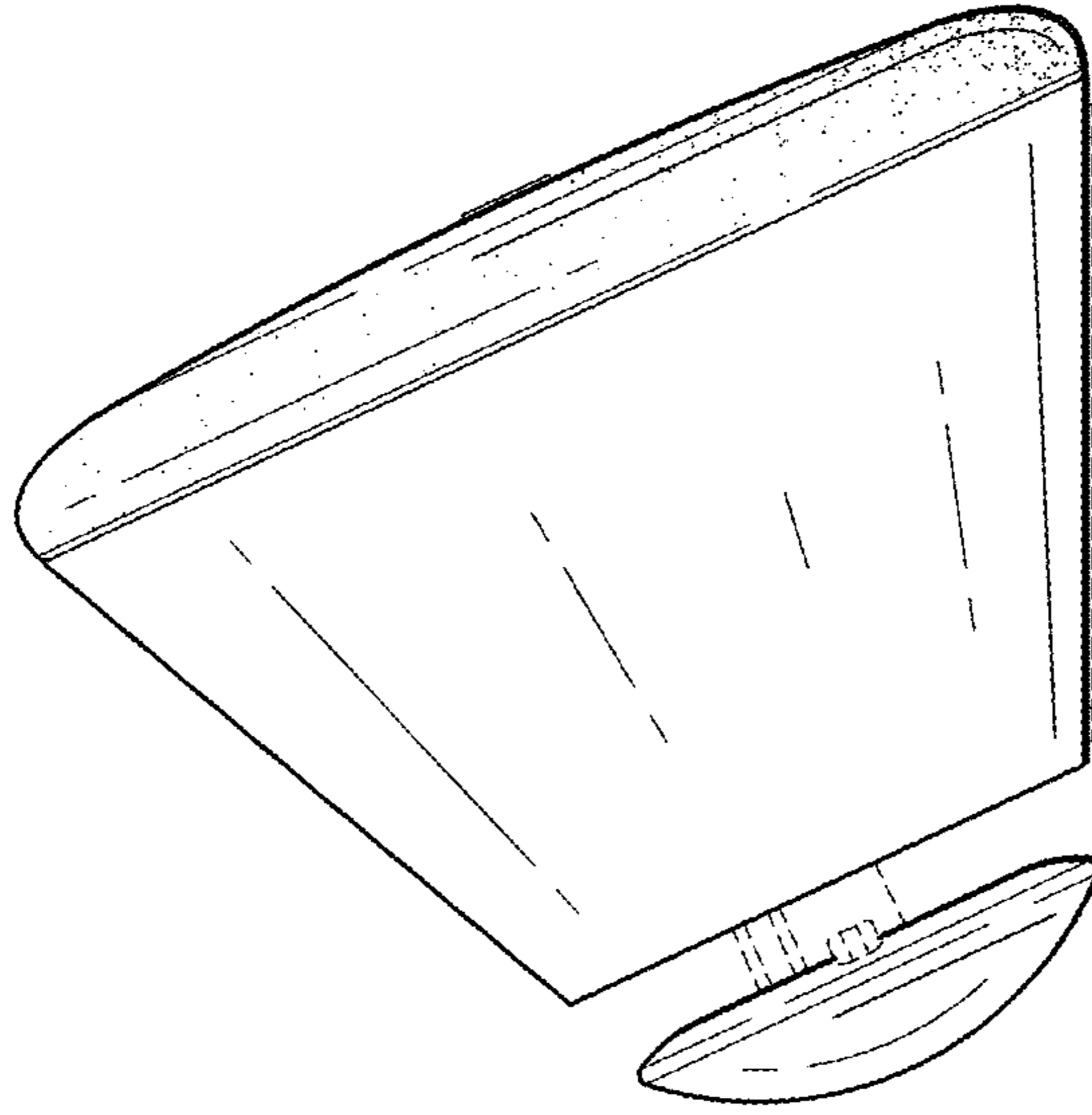

FIG. 5

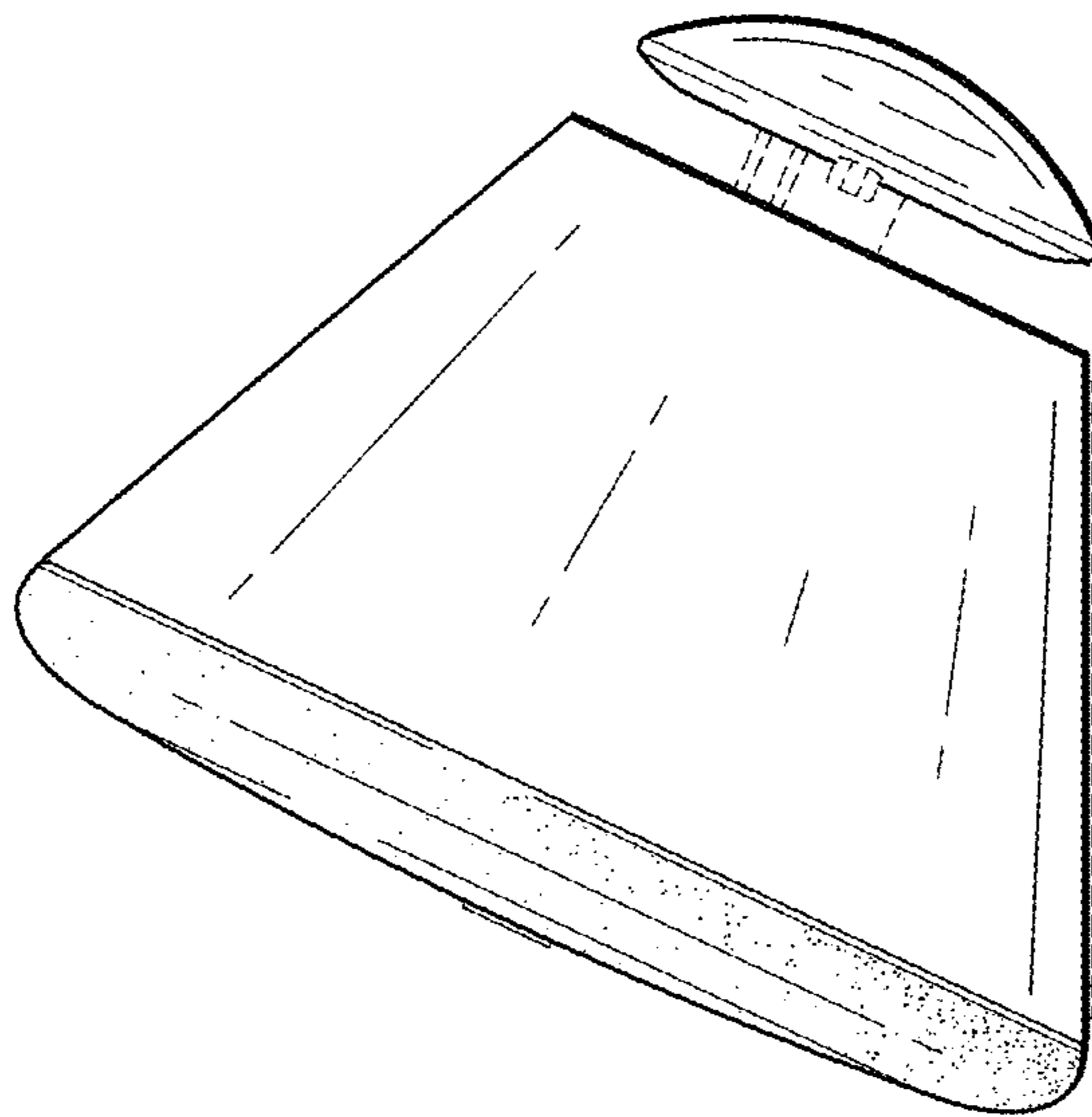

FIG. 4

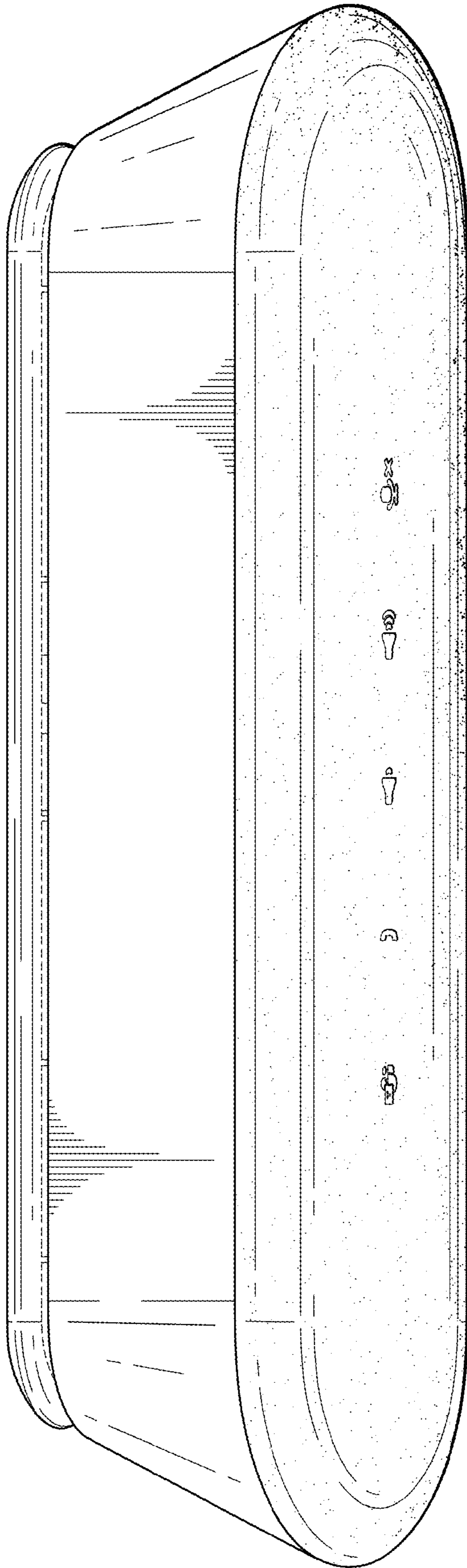

FIG. 6

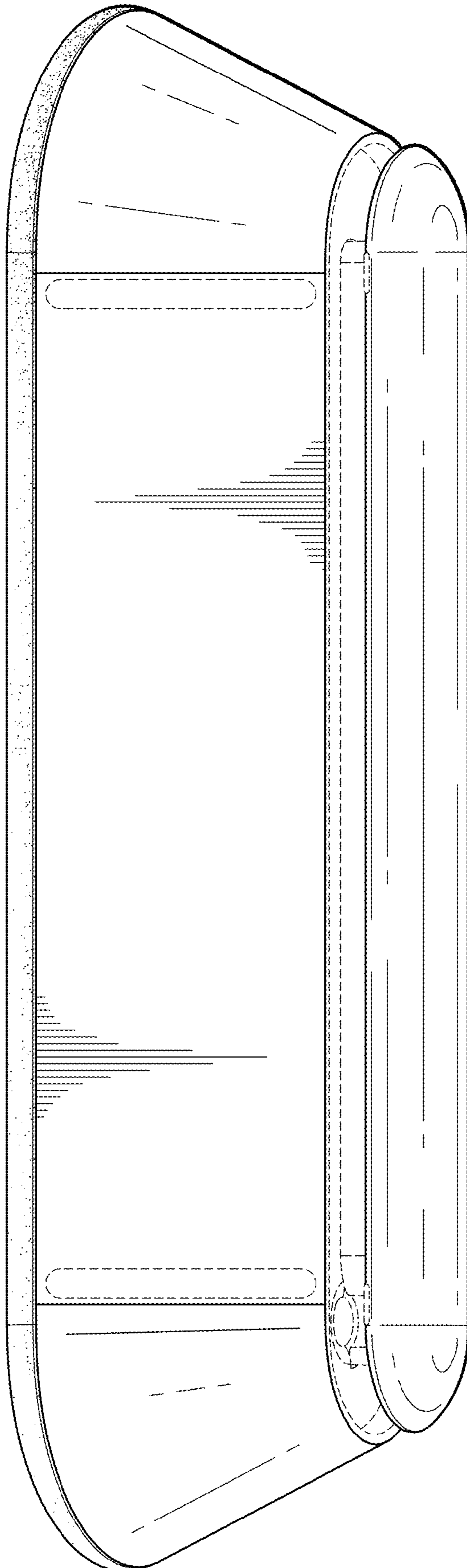

FIG. 7