

US00D962148S

(12) **United States Design Patent** (10) **Patent No.:** **US D962,148 S**
Anderson et al. (45) **Date of Patent:** **** Aug. 30, 2022**

(54) **CANOPY** D727,244 S * 4/2015 Hashimoto D12/401
D733,033 S * 6/2015 Rohr D12/401
(71) Applicant: **Caterpillar Paving Products Inc.**,
Brooklyn Park, MN (US) D742,935 S 11/2015 Ewringmann
D755,254 S 5/2016 Ewringmann
D755,255 S 5/2016 Ewringmann
(Continued)

(72) Inventors: **Bradley Anderson**, Rogers, MN (US);
Michael S. Hemry, Maple Grove, MN
(US)

FOREIGN PATENT DOCUMENTS

(73) Assignee: **Caterpillar Inc.**, Peoria, IL (US)

CN 201961386 U 9/2011
CN 205292808 U 6/2016

(**) Term: **15 Years**

(Continued)

(21) Appl. No.: **29/750,971**

OTHER PUBLICATIONS

(22) Filed: **Sep. 17, 2020**

Caterpillar Inc., "Asphalt Pavers AP555F", <https://www.cat.com/en_ZA/products/new/equipment/asphalt-pavers/track-asphalt-pavers/1000012261.html>, available as early as Jan. 15, 2019.

Related U.S. Application Data

(Continued)

(63) Continuation of application No. 29/684,357, filed on
Mar. 20, 2019, now Pat. No. Des. 902,832.

(51) **LOC (13) Cl.** **12-16**

(52) **U.S. Cl.**
USPC **D12/401**

(58) **Field of Classification Search**
USPC D12/401-405, 181; D6/610, 611, 596,
D6/601-603, 615, 617, 621; D7/332,
D7/334-337

CPC ... B60J 7/19; B60J 7/0435; B60J 7/024; B60J
11/04; B60J 1/2091; B60J 7/11; E04H
15/08

See application file for complete search history.

Primary Examiner — Katrina A Betton

(74) *Attorney, Agent, or Firm* — Saidman Design Law
Group

(57) **CLAIM**

The ornamental design for a canopy, as shown and
described.

DESCRIPTION

FIG. 1 is a top perspective view of a canopy showing our
new design;
FIG. 2 is a bottom perspective view thereof;
FIG. 3 is a front view thereof;
FIG. 4 is a rear view thereof;
FIG. 5 is a left side view thereof;
FIG. 6 is a right side view thereof;
FIG. 7 is a top view thereof; and,
FIG. 8 is a bottom view thereof.

The drawings include surface shading which illustrates
contour and not surface ornamentation.

1 Claim, 5 Drawing Sheets

(56) **References Cited**

U.S. PATENT DOCUMENTS

D306,570 S * 3/1990 Lomonaco D12/401
D444,762 S 7/2001 Werle et al.
D549,638 S * 8/2007 Hughes D12/401
D639,229 S * 6/2011 van Voorst tot Voorst
D12/401
D687,760 S 8/2013 Gros
8,950,803 B2 2/2015 Herzberg et al.
D727,243 S * 4/2015 Matsumura D12/401

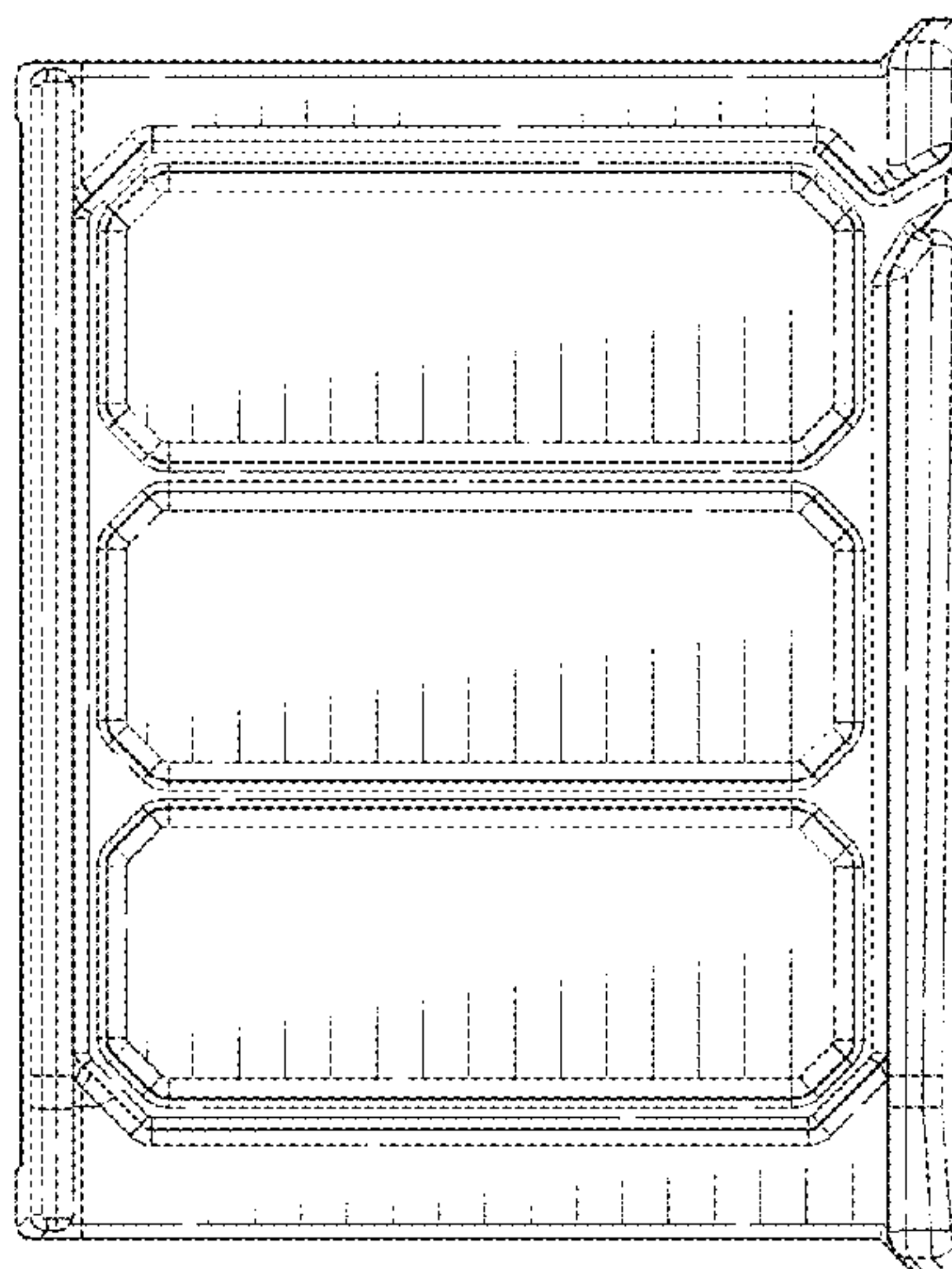

(56)

References Cited

U.S. PATENT DOCUMENTS

D769,334 S	10/2016	Ewringmann	
D773,535 S	12/2016	Ewringmann	
D776,601 S *	1/2017	McDonald, II	D12/401
D799,387 S	10/2017	Malina et al.	
D829,634 S	10/2018	Chapman et al.	
D832,185 S *	10/2018	McIntire	D12/401
D847,078 S *	4/2019	Rolfs	D12/401
D852,725 S	7/2019	Feng et al.	
D859,281 S *	9/2019	McDonald, II	D12/401
D863,197 S *	10/2019	Gordon	D12/401
D865,641 S	11/2019	Austin	
D887,952 S	6/2020	Cho et al.	
D891,356 S *	7/2020	Sprowl	D12/401
D947,096 S *	3/2022	Rudolph	D12/401

FOREIGN PATENT DOCUMENTS

EP	3115238 A1	1/2017
WO	2016/014034 A1	1/2016

OTHER PUBLICATIONS

Caterpillar Inc., "Asphalt Pavers AP655FL", <https://www.cat.com/en_ZA/products/new/equipment/asphalt-pavers/track-asphalt-pavers/89679634742.html>, available as early as Jan. 15, 2019.

Caterpillar Inc., "Asphalt Pavers AP500F", <https://www.cat.com/en_ZA/products/new/equipment/asphalt-pavers/wheel-asphalt-pavers/1000012260.html>, available as early as Jan. 15, 2019.

Vögele, "Super 2100-3i", <<https://www.voegele.info/en-us/range-of-products/super-series/highway-class/super-2100-3i/photo-gallery.php#limperial>>, available as early as Jan. 15, 2019.

Vögele, "Super 1700-3i", <<https://www.voegele.info/en-us/range-of-products/super-series/universal-class/super-1700-3i/photo-gallery.php#limperial>>, available as early as Jan. 15, 2019.

Vögele, "Special Class MT 3000=2i Offset POWERFEEDER", <https://media.voegele.info/media/03_voegele/produkte/broschueren/04_spezialger_te/power_feeder_1/mt_3000_2i_offset_us_1/MT3000-2iOffset_US_2506227_0116_mPW_Lay2016.pdf>, available as early as Jan. 15, 2019.

U.S. Appl. No. 29/684,357, filed Mar. 20, 2019. (Unpublished).

* cited by examiner

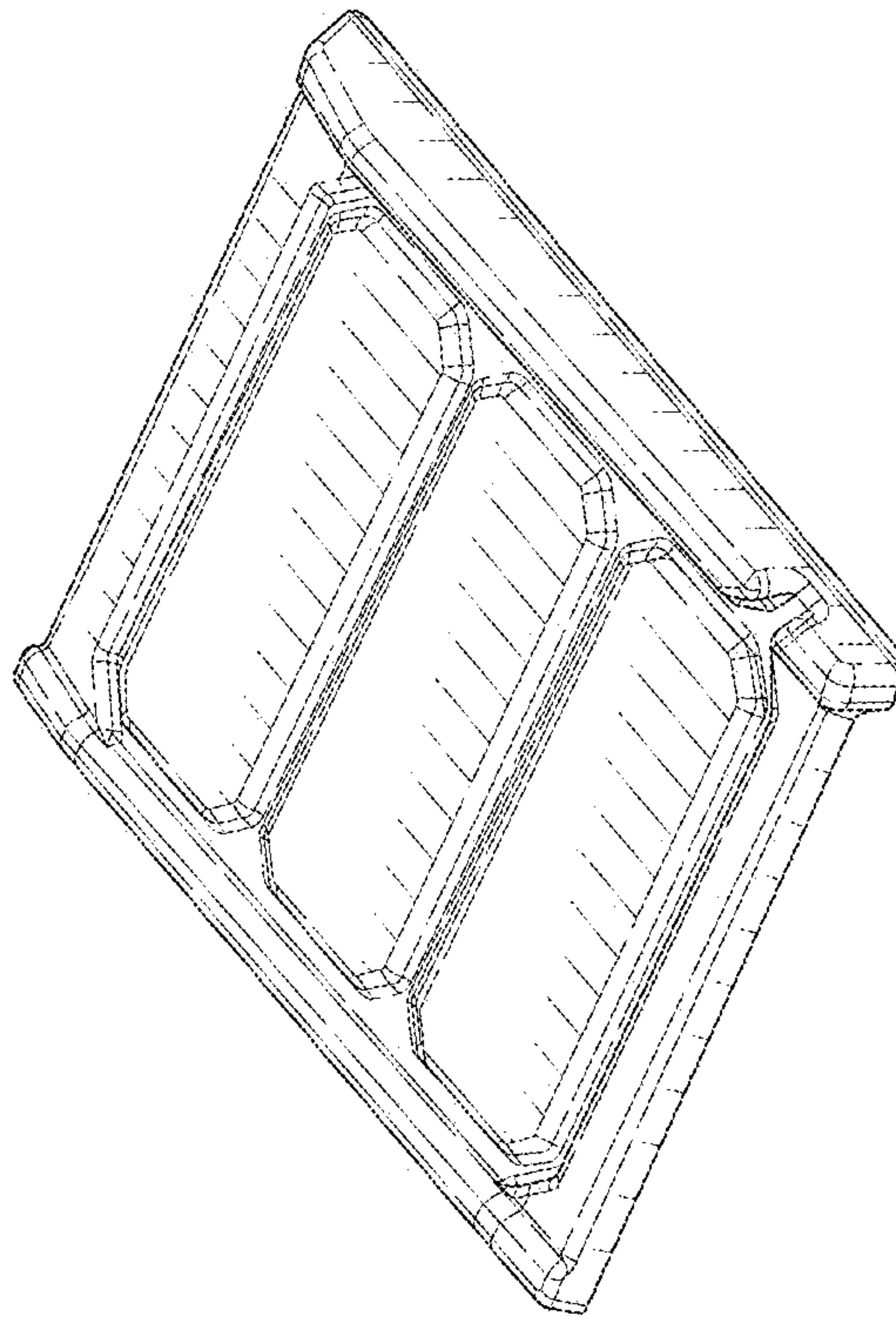

FIG. 1

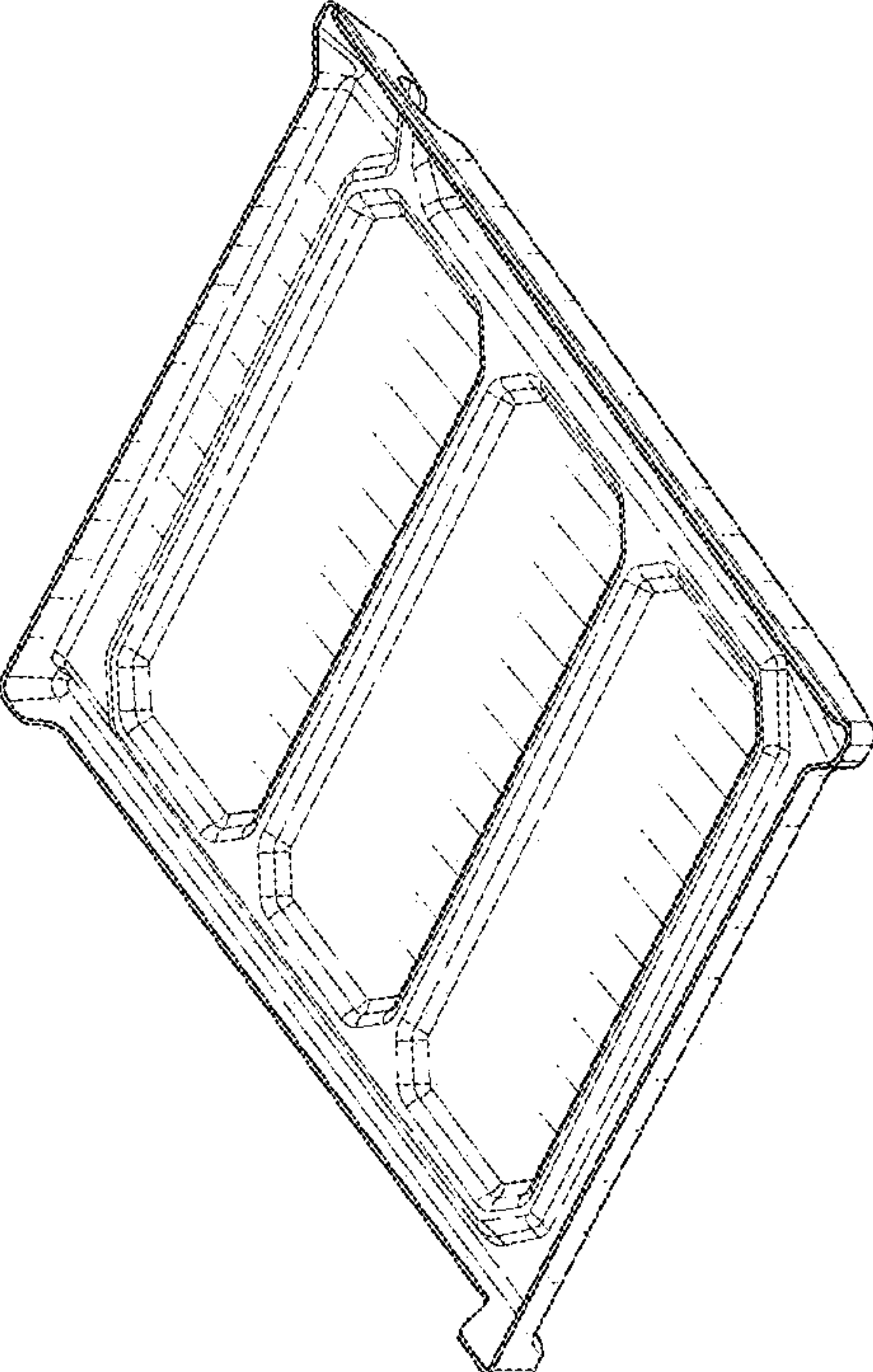

FIG. 2

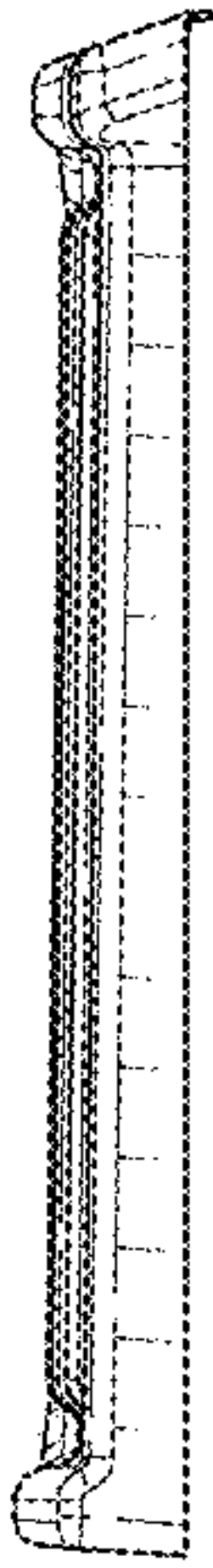

FIG. 3



FIG. 4



FIG. 5

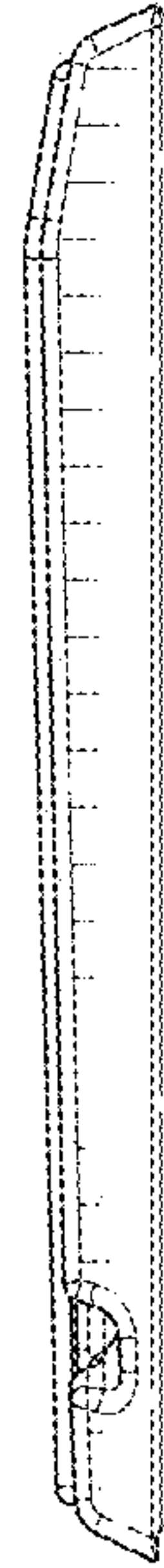

FIG. 6

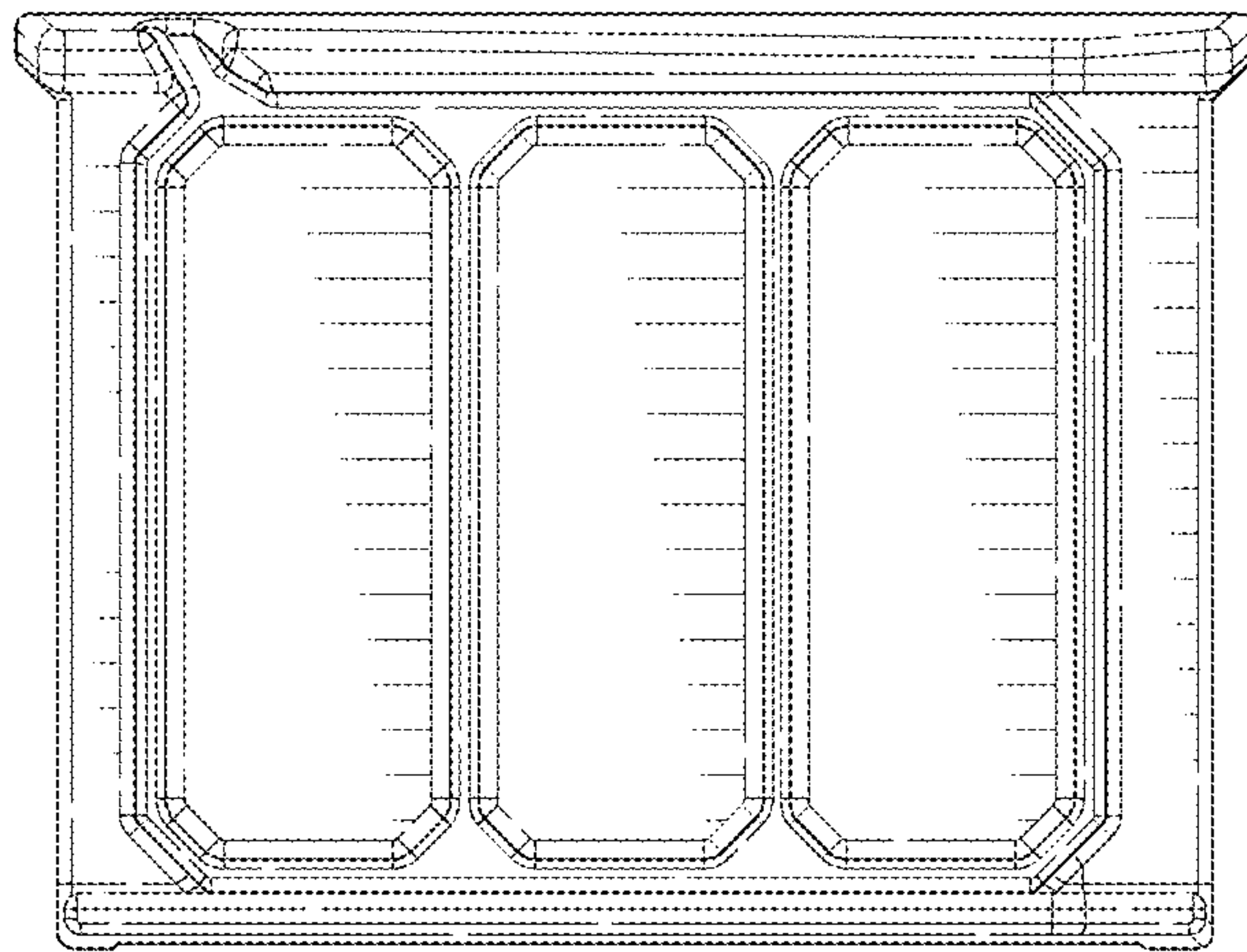

FIG. 7

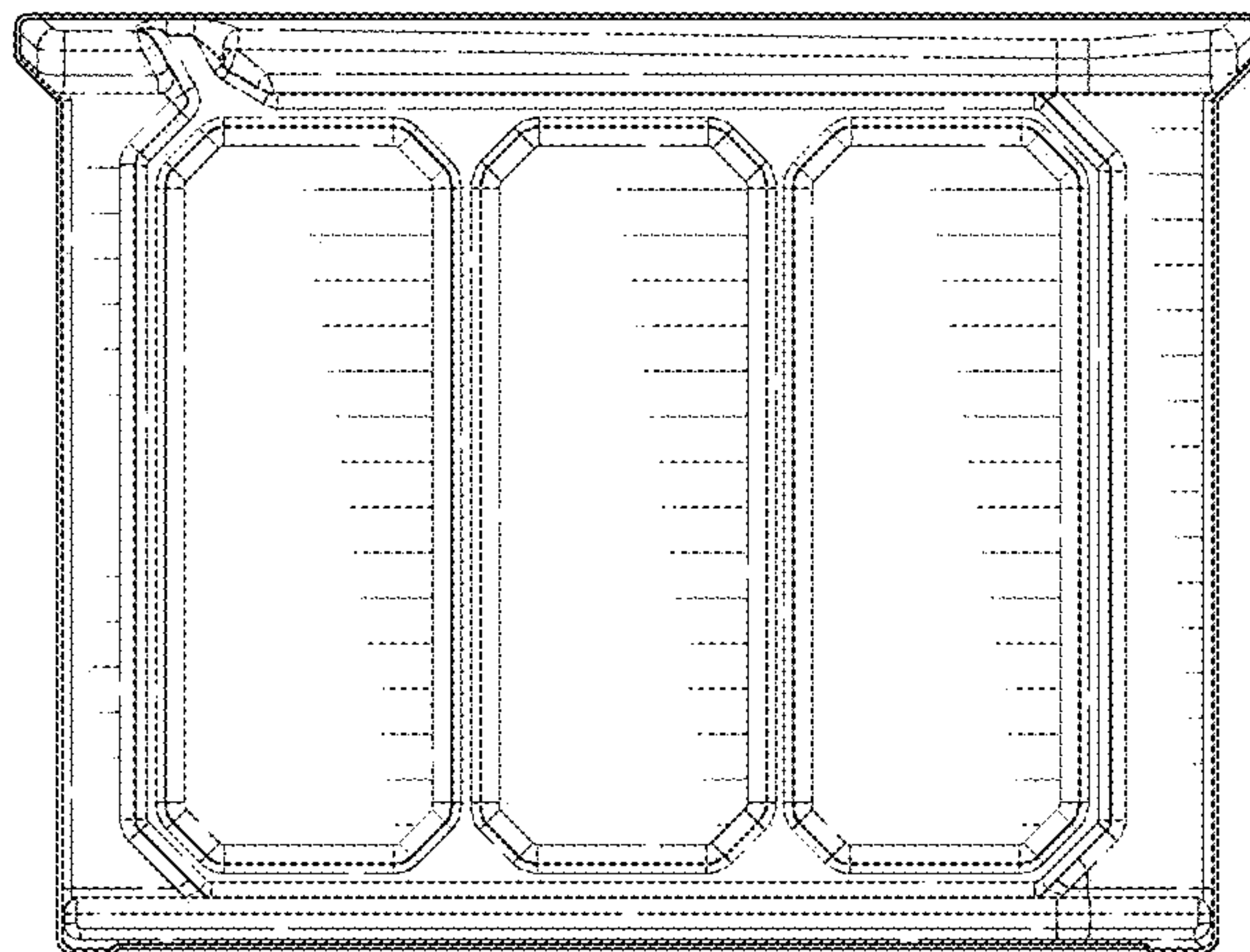

FIG. 8