

US00D962135S

(12) **United States Design Patent**
Chen

(10) **Patent No.:** **US D962,135 S**

(45) **Date of Patent:** **** Aug. 30, 2022**

- (54) **VEHICLE REAR SPOILER**
- (71) Applicant: **Caruse Design, Inc.**, Chino Hills, CA (US)
- (72) Inventor: **Allan Chen**, Yilan (TW)
- (73) Assignee: **CARUSE DESIGN, INC.**, Chino Hills, CA (US)
- (**) Term: **15 Years**
- (21) Appl. No.: **29/770,091**
- (22) Filed: **Feb. 9, 2021**
- (51) **LOC (13) Cl.** **12-16**
- (52) **U.S. Cl.**
USPC **D12/181**
- (58) **Field of Classification Search**
USPC D12/181-184, 191, 400, 190
CPC B62D 35/00; B62D 35/007; B62D 35/02
See application file for complete search history.

- D906,201 S * 12/2020 Chen D12/181
- D907,549 S * 1/2021 Chiang D12/181
- D919,522 S * 5/2021 Chen D12/181
- D919,523 S * 5/2021 Chen D12/181
- D932,963 S * 10/2021 Chen D12/181
- D943,476 S * 2/2022 Chen D12/181
- D943,477 S * 2/2022 Chen D12/181
- D944,155 S * 2/2022 Chen D12/181

* cited by examiner

Primary Examiner — Susan E Krakower

Assistant Examiner — Jerry Shiuan-Hua Hsu

(74) *Attorney, Agent, or Firm* — Chun-Ming Shih; HDLS IPR Services

(57) **CLAIM**

The ornamental design for a vehicle rear spoiler, as shown and described.

DESCRIPTION

FIG. 1 is a top, front, right perspective view of a vehicle rear spoiler showing my design;
 FIG. 2 is a front elevational view thereof;
 FIG. 3 is a rear elevational view thereof;
 FIG. 4 is a left side elevational view thereof;
 FIG. 5 is a right side elevational view thereof;
 FIG. 6 is a top plan view thereof;
 FIG. 7 is a bottom plan view thereof; and,
 FIG. 8 is a bottom, rear, left perspective view thereof.

1 Claim, 6 Drawing Sheets

- (56) **References Cited**
U.S. PATENT DOCUMENTS
D746,191 S * 12/2015 Chen D12/181
D905,602 S * 12/2020 Chen D12/181
D905,603 S * 12/2020 DiCanzio D12/181

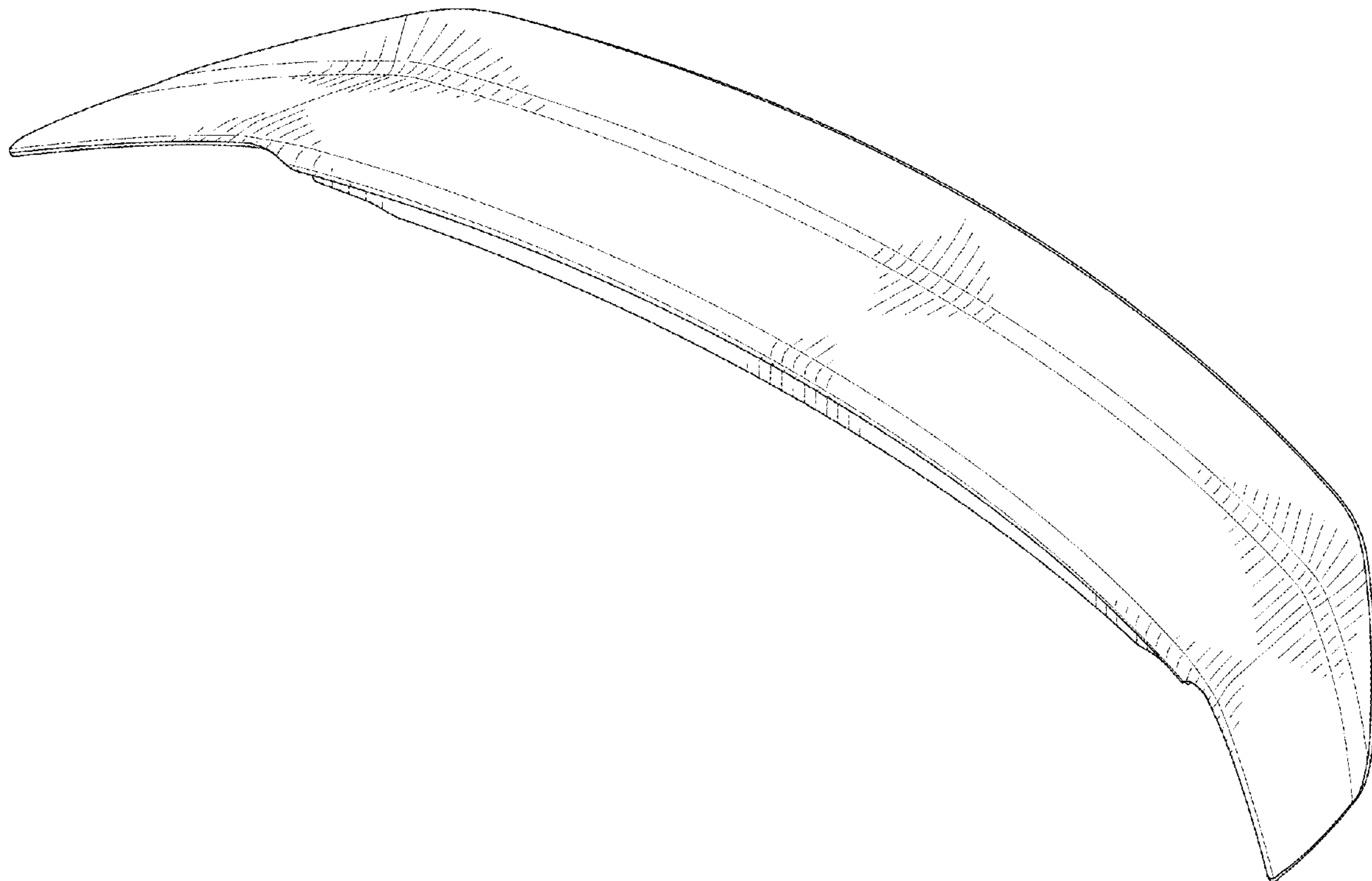

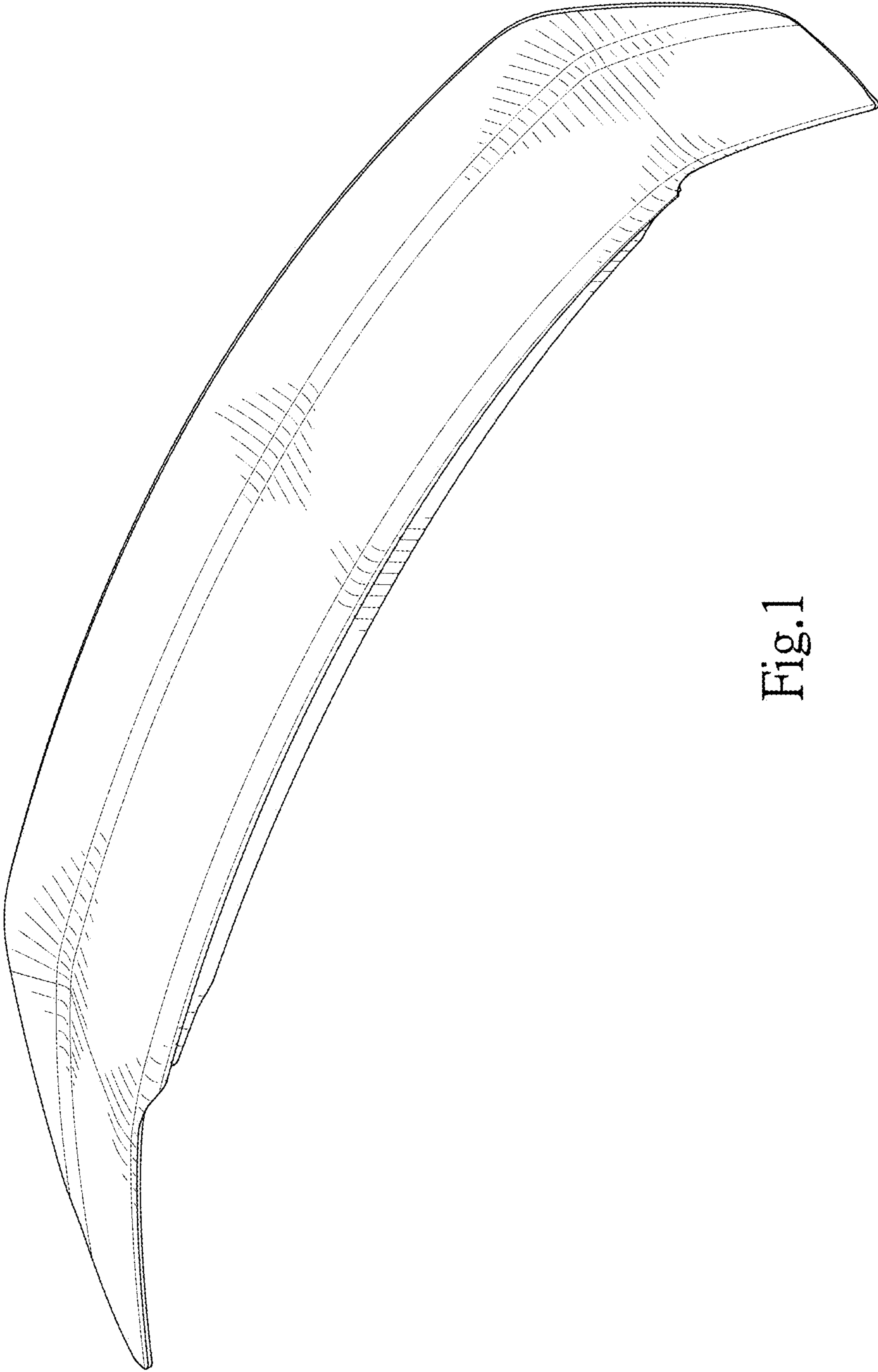

Fig.1

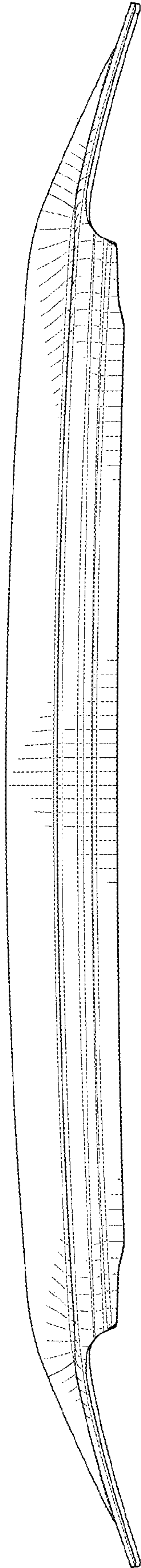

Fig.2

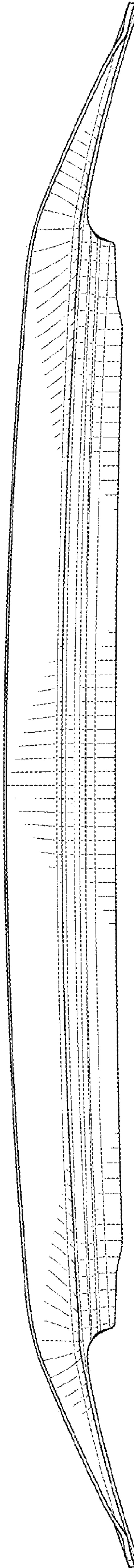

Fig.3

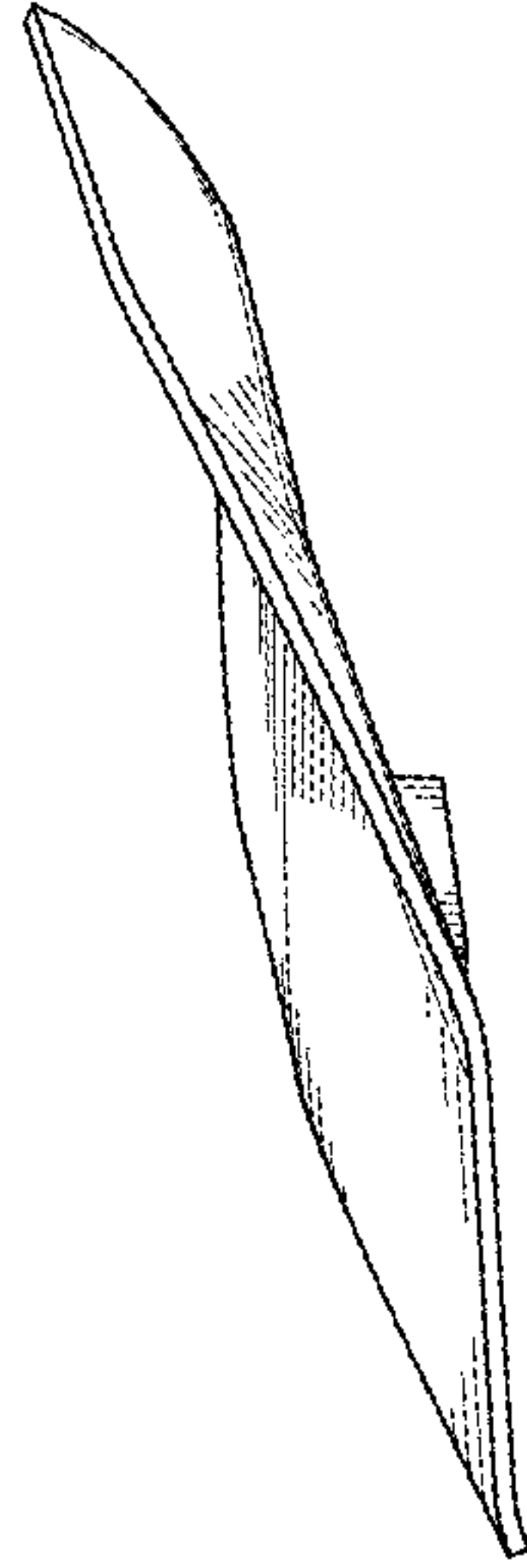

Fig.5

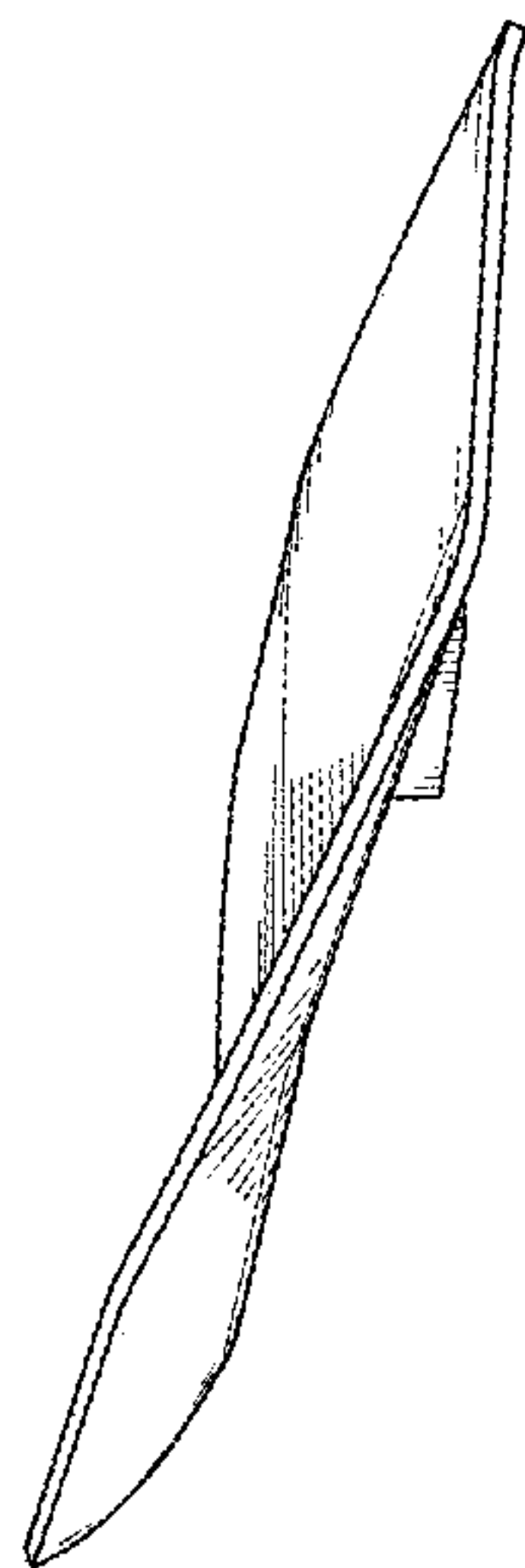

Fig.4

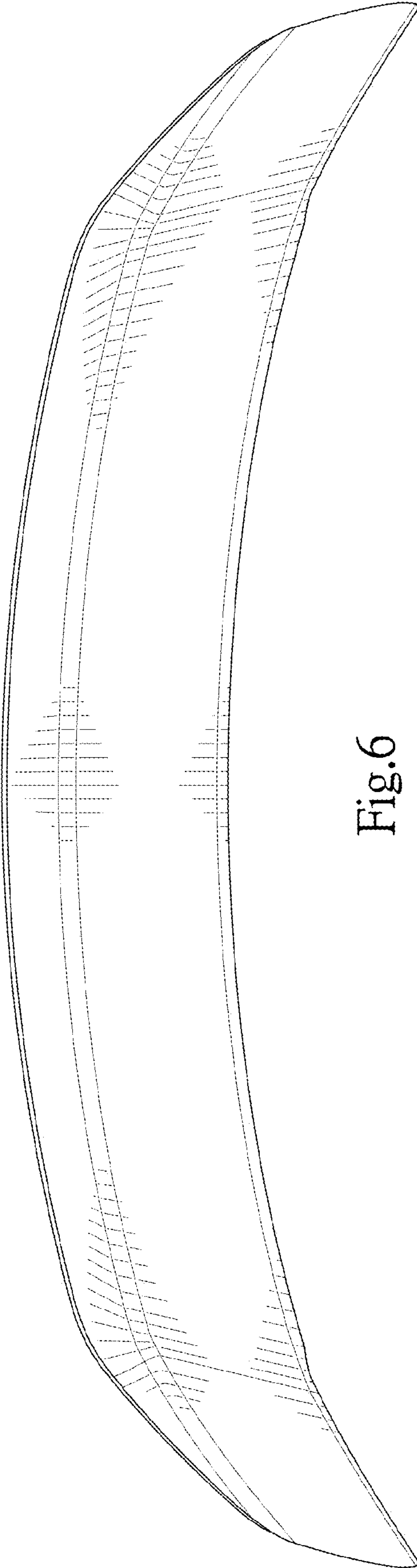

Fig. 6

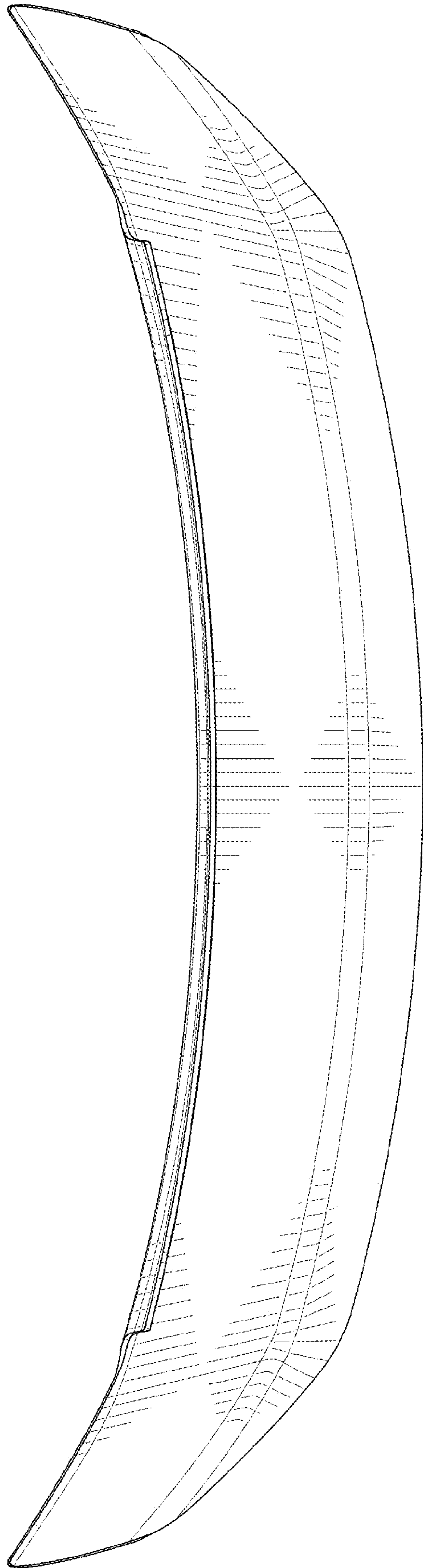

Fig.7

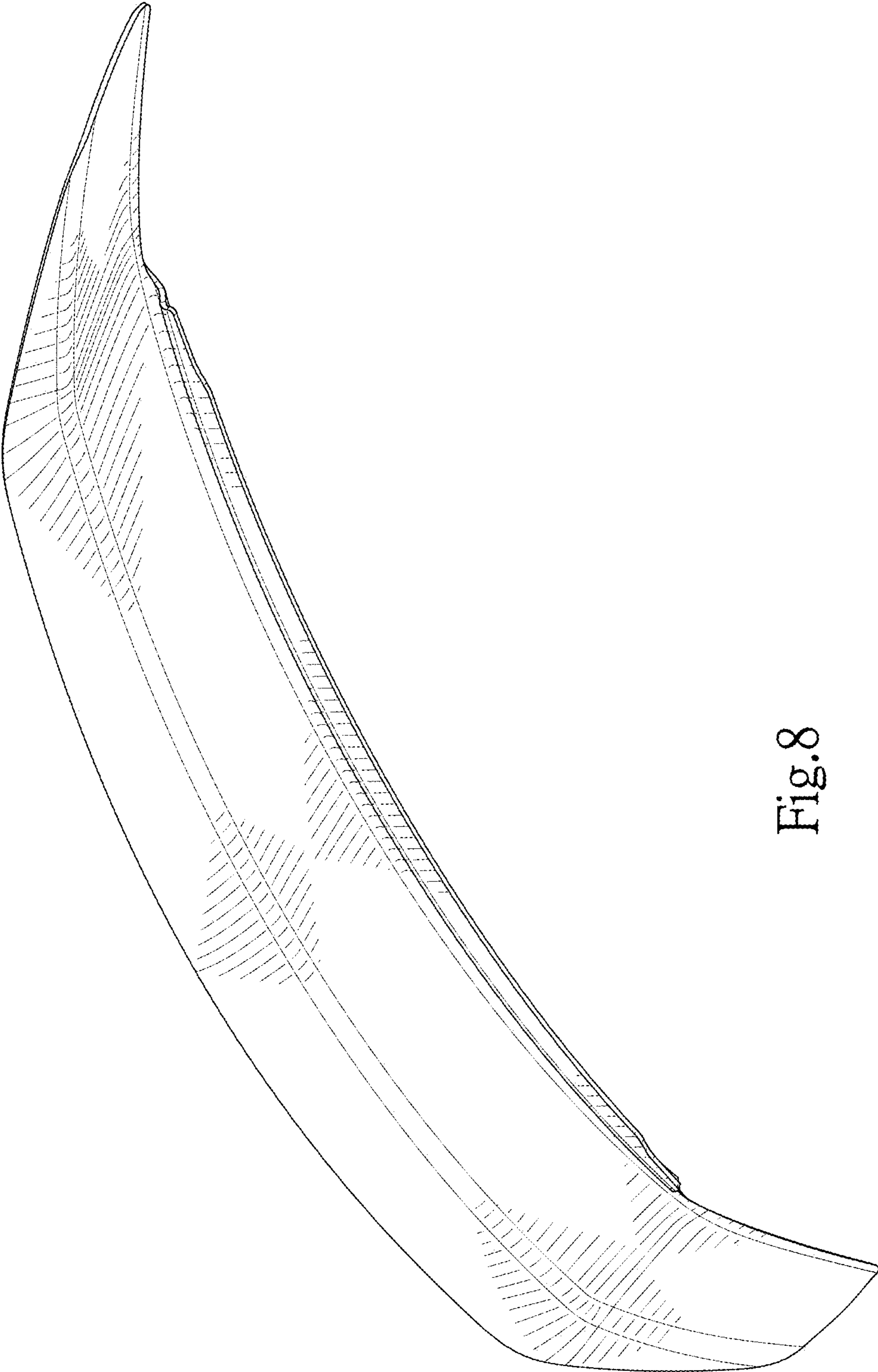

Fig.8