



US00D962074S

(12) **United States Design Patent**
Satoh et al.

(10) **Patent No.:** **US D962,074 S**
(45) **Date of Patent:** **** Aug. 30, 2022**

(54) **PACKAGING CONTAINER**

(71) Applicant: **KOSE CORPORATION**, Tokyo (JP)

(72) Inventors: **Taku Satoh**, Tokyo (JP); **Yuki Yoshida**, Tokyo (JP); **Naoko Yokokura**, Tokyo (JP); **Moe Kono**, Tokyo (JP)

(73) Assignee: **KOSE CORPORATION**, Tokyo (JP)

(**) Term: **15 Years**

(21) Appl. No.: **29/751,078**

(22) Filed: **Sep. 18, 2020**

(30) **Foreign Application Priority Data**

Mar. 26, 2020 (JP) 2020-005809

(51) **LOC (13) Cl.** **09-01**

(52) **U.S. Cl.**
USPC **D9/549**

(58) **Field of Classification Search**

USPC D9/521, 522, 529, 549, 551, 552, 554,
D9/558, 559, 560, 561, 562, 566, 567,
D9/570-575, 430, 433, 434, 454, 500,
D9/501, 503, 504, 682, 686, 691, 693,
D9/423, 530, 542, 543, 550, 563;
D28/73, 76, 78, 82, 88, 83, 85;
D3/203.1, 205, 206, 903

CPC A45D 40/0068; A45D 2200/051; B65D
2251/0015; B65D 50/041; B65D
2501/0081; B65D 1/0223; B65D 23/102;
B65D 2501/00; B65D 2501/0009

See application file for complete search history.

(56) **References Cited**

U.S. PATENT DOCUMENTS

D468,209 S * 1/2003 Joubert D9/561
D468,646 S * 1/2003 Joubert D9/561

D472,152 S * 3/2003 Joubert D9/561
D476,902 S * 7/2003 Snyder D9/575
D521,384 S * 5/2006 Priestman D9/504

(Continued)

FOREIGN PATENT DOCUMENTS

CN 301713312 * 11/2011
CN 303421757 * 10/2015

(Continued)

OTHER PUBLICATIONS

Rachel, Sep. 2, 2020, *Girlstyle.com/KOSÉ SEKKISEI Just Launched Their First Sustainable Skincare Products With Plant-Based Ingredients*, URL: <https://girlstyle.com/sg/article/72760/kose-sekkisei-review-singapore> (Year: 2020).*

(Continued)

Primary Examiner — Brett Miller

Assistant Examiner — Rani J Abdallah

(74) *Attorney, Agent, or Firm* — Bacon & Thomas, PLLC

(57) **CLAIM**

The ornamental design for a packaging container, as shown and described.

DESCRIPTION

FIG. 1 is a perspective view of a packaging container, showing our new design.

FIG. 2 is a front view thereof.

FIG. 3 is a rear view thereof.

FIG. 4 is a top plan view thereof.

FIG. 5 is a bottom plan view thereof.

FIG. 6 is a right side view thereof.

FIG. 7 is a left side view thereof; and,

FIG. 8 is a sectional view taken along line 8-8 of FIG. 2.

The broken lines in the figures illustrate the portions of the packaging container that form no part of the claimed design.

1 Claim, 8 Drawing Sheets

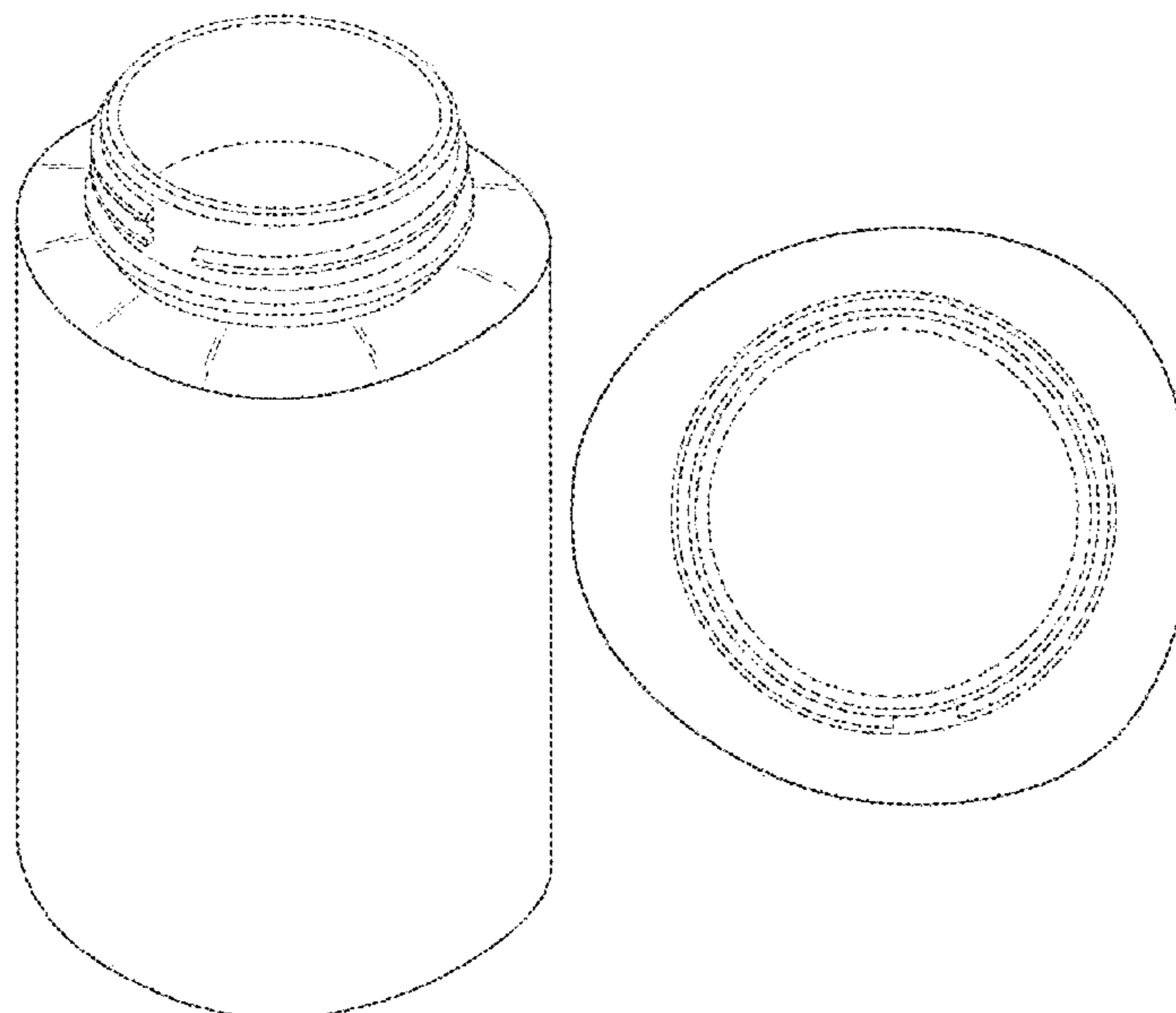

(56)

References Cited

U.S. PATENT DOCUMENTS

D521,386 S * 5/2006 Priestman D28/76
 D526,205 S * 8/2006 Priestman D9/504
 D532,308 S * 11/2006 Davies D9/529
 D539,161 S * 3/2007 Cornet D9/558
 D563,233 S * 3/2008 Patzak D9/558
 D619,467 S * 7/2010 Bogosyan D9/561
 D666,912 S * 9/2012 Kawai D9/504
 D671,836 S * 12/2012 DeMarco D9/503
 D691,889 S * 10/2013 Mettler D9/504
 D709,379 S * 7/2014 Moretti D9/558
 D731,893 S * 6/2015 Chung D9/560
 D739,251 S * 9/2015 Kawai D9/542
 D746,141 S * 12/2015 Watabe D9/503
 D758,664 S * 6/2016 Van Maanen D28/76
 D776,545 S * 1/2017 Wiggins D9/561
 D790,969 S * 7/2017 Eastcott D9/522
 D790,976 S * 7/2017 Eastcott D9/561
 D805,351 S * 12/2017 Hayami D9/504
 D820,093 S * 6/2018 Pontes D9/529
 D838,599 S * 1/2019 Corrigan D9/561
 D839,745 S * 2/2019 Rehman D9/542

D840,826 S * 2/2019 Clark D9/574
 D855,891 S * 8/2019 Lin D9/561
 D895,432 S * 9/2020 Yoshioka D9/561
 D909,874 S * 2/2021 Lee D9/503
 D942,693 S * 2/2022 Zeng D9/504

FOREIGN PATENT DOCUMENTS

| | | | |
|----|----------------|---|---------|
| CN | 303576888 | * | 2/2016 |
| CN | 305031206 | * | 2/2019 |
| CN | 305894070 | * | 7/2020 |
| GB | 2068153 | * | 3/1998 |
| KR | 301019551.0000 | * | 8/2019 |
| KR | 301026428.0000 | * | 10/2019 |
| KR | 301037963.0000 | * | 12/2019 |

OTHER PUBLICATIONS

Heidi, May 12, 2010, thefrugalgirls.com post | DIY Foaming Hand Soap Recipe! {Homemode Refill}, URL: <https://thefrugalgirls.com/2010/05/diy-foaming-hand-soap-recipe.html> (Year: 2010).*

* cited by examiner

FIG. 1

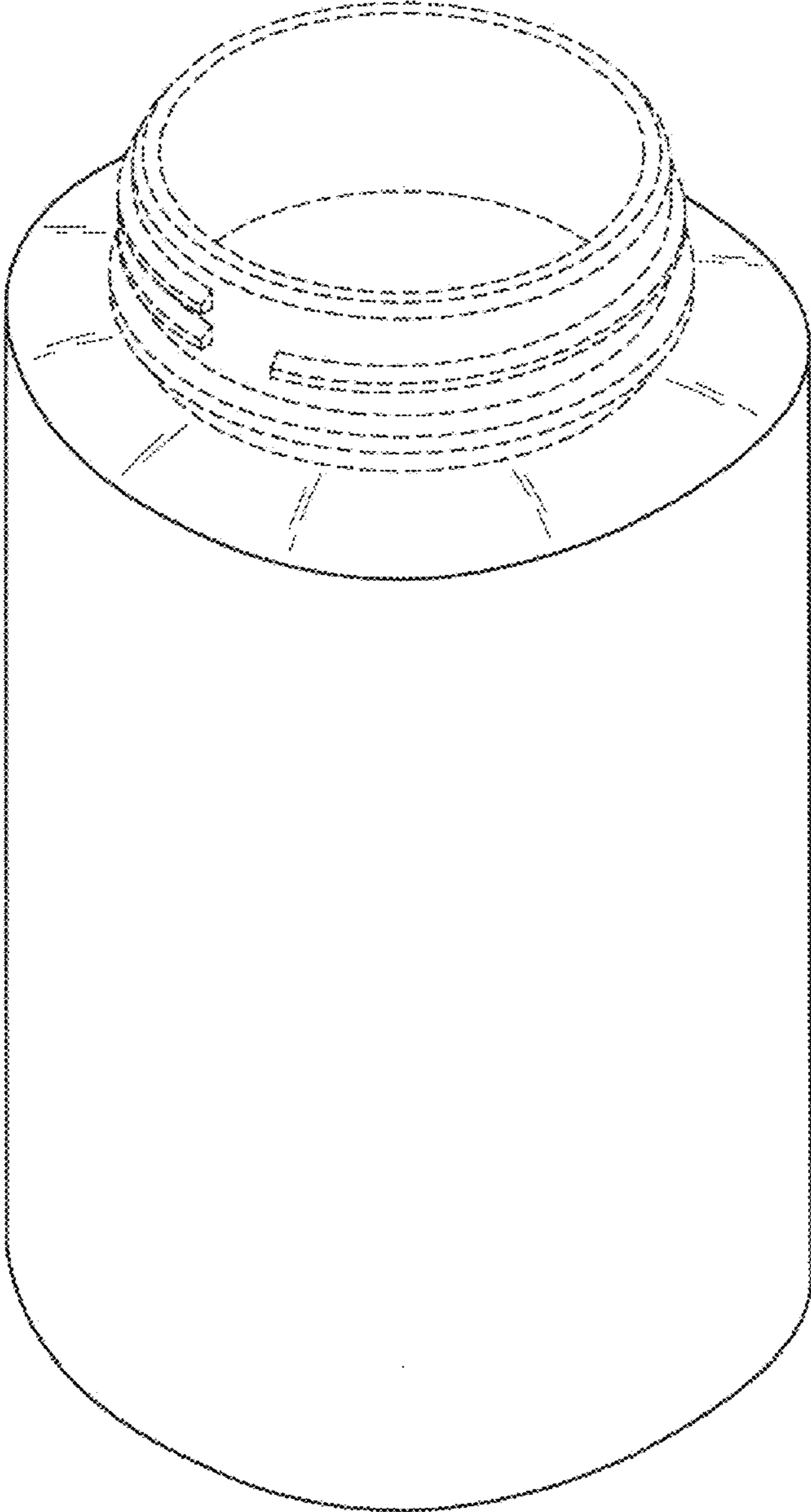

FIG. 2

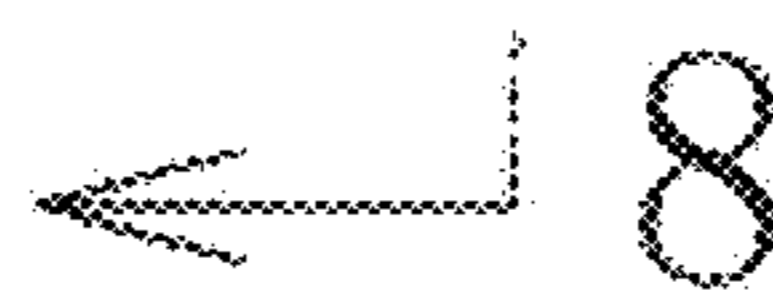
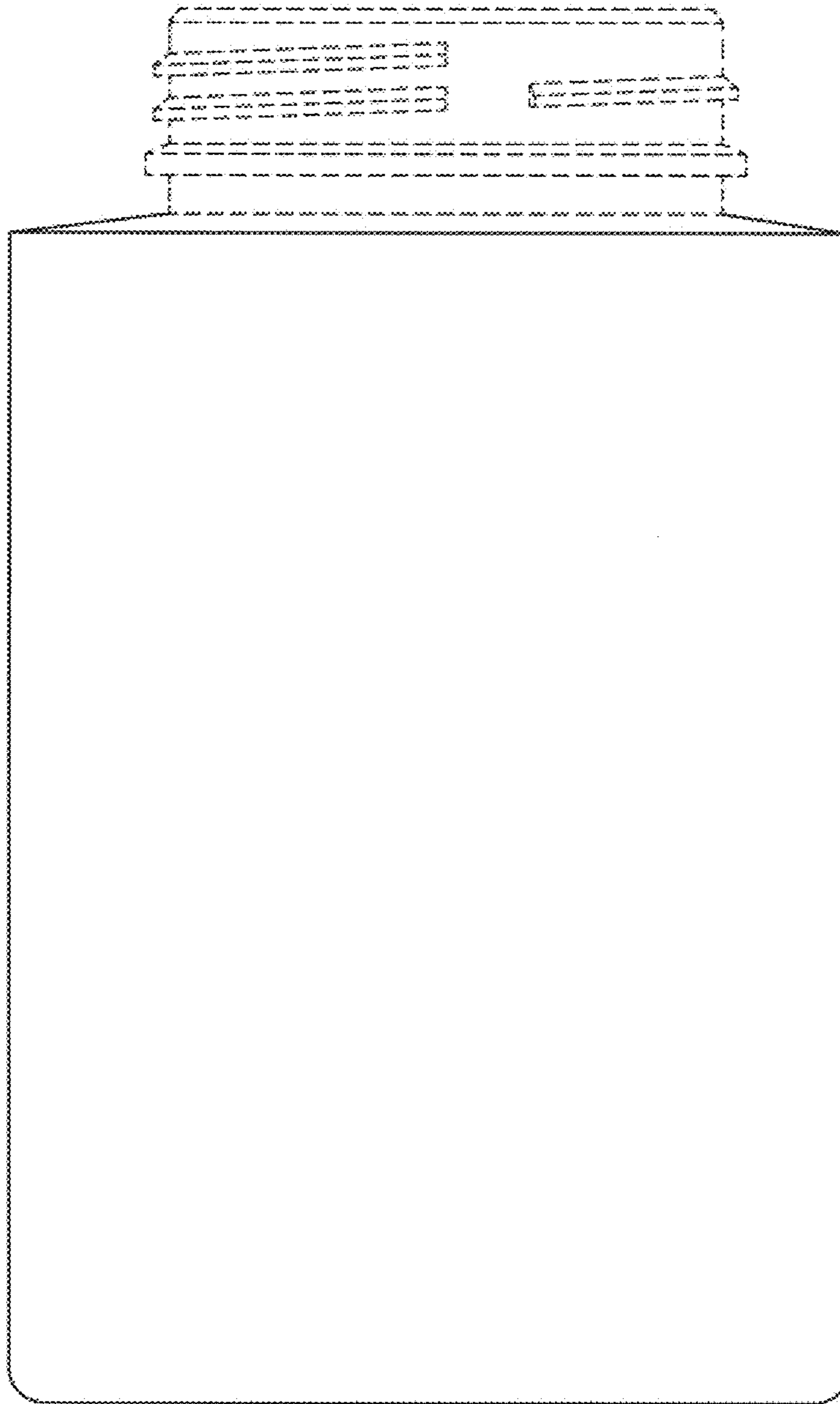
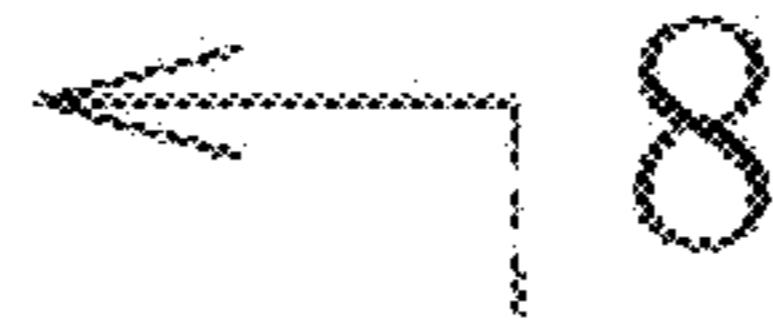

FIG. 3

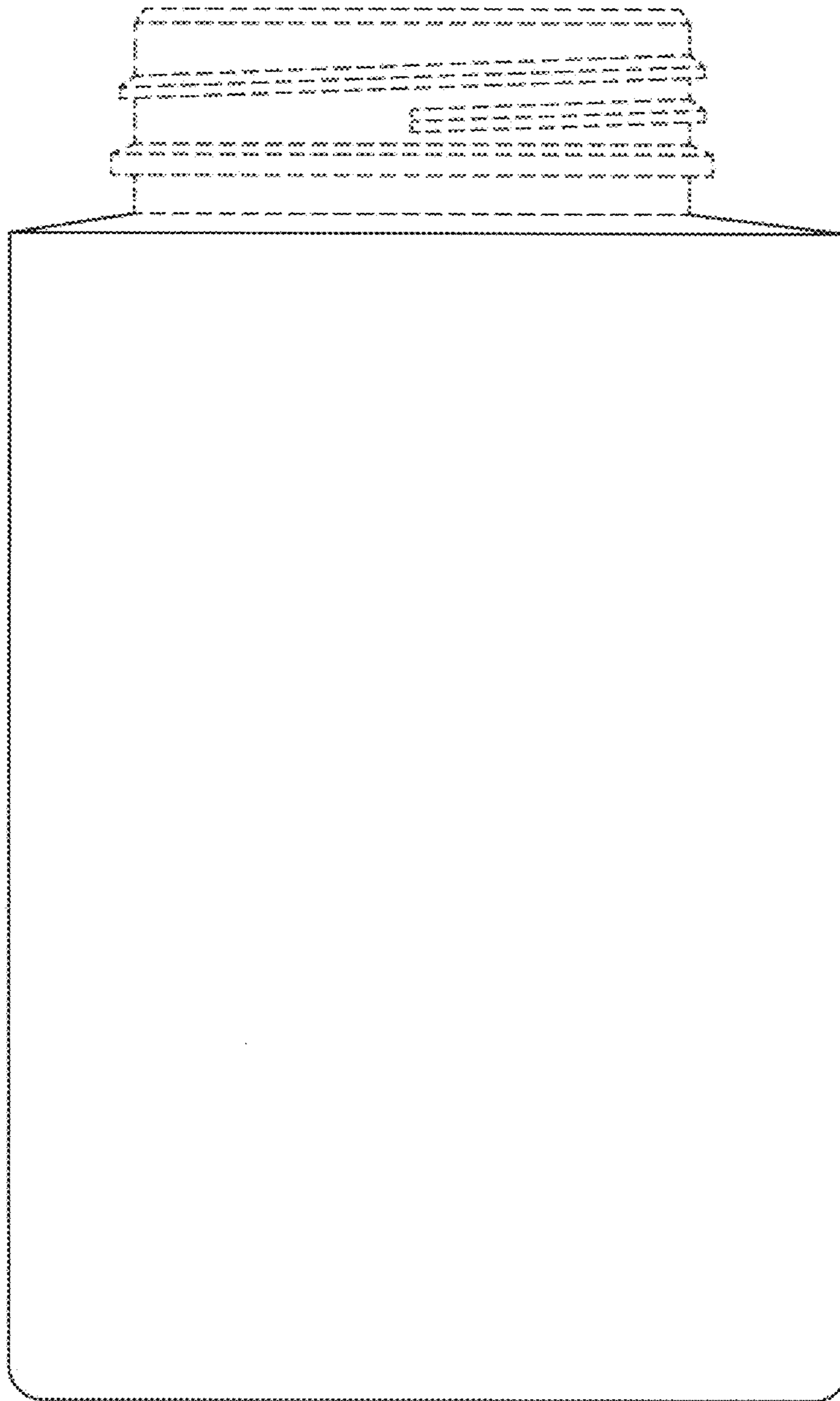

FIG. 4

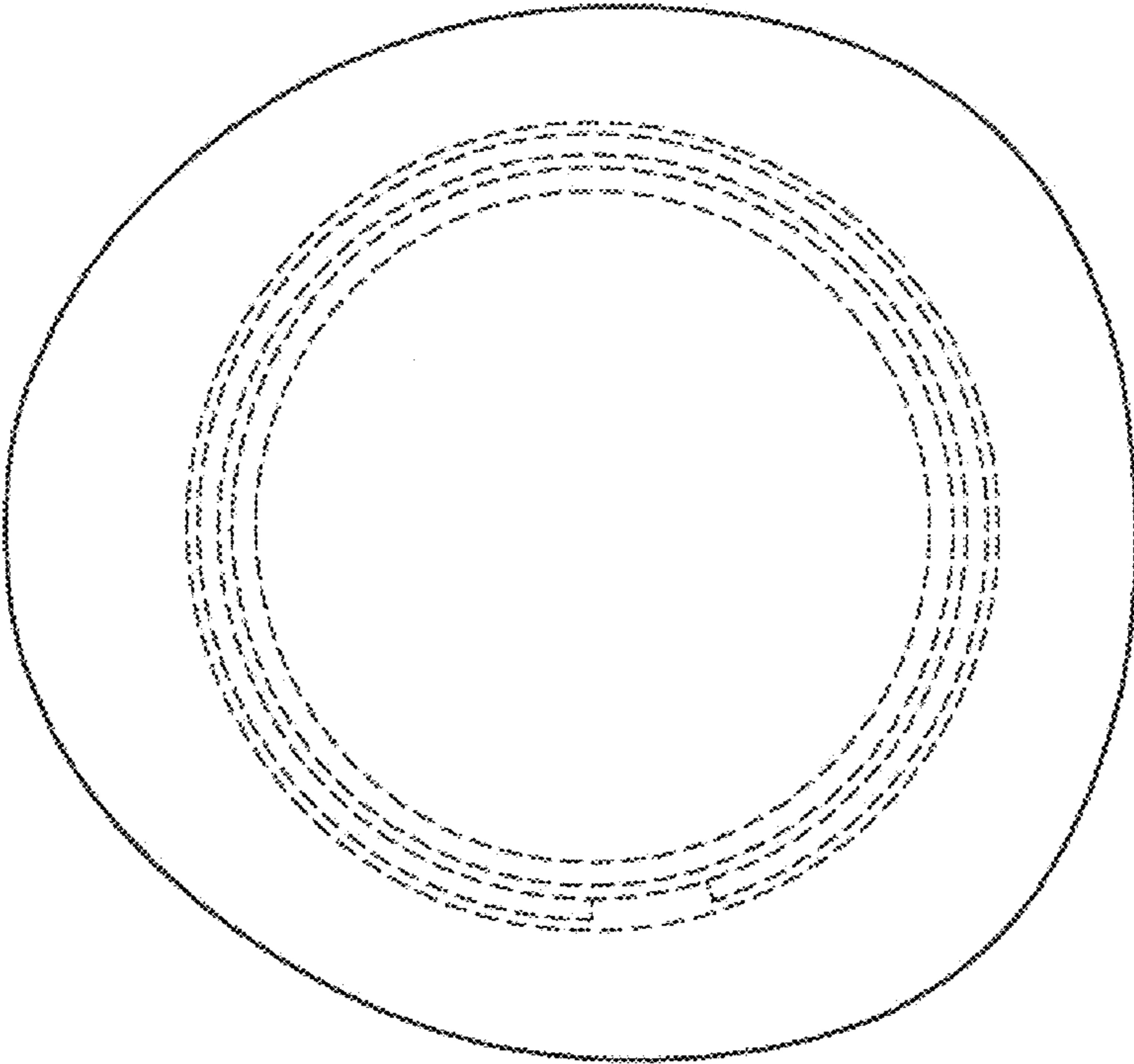

FIG. 5

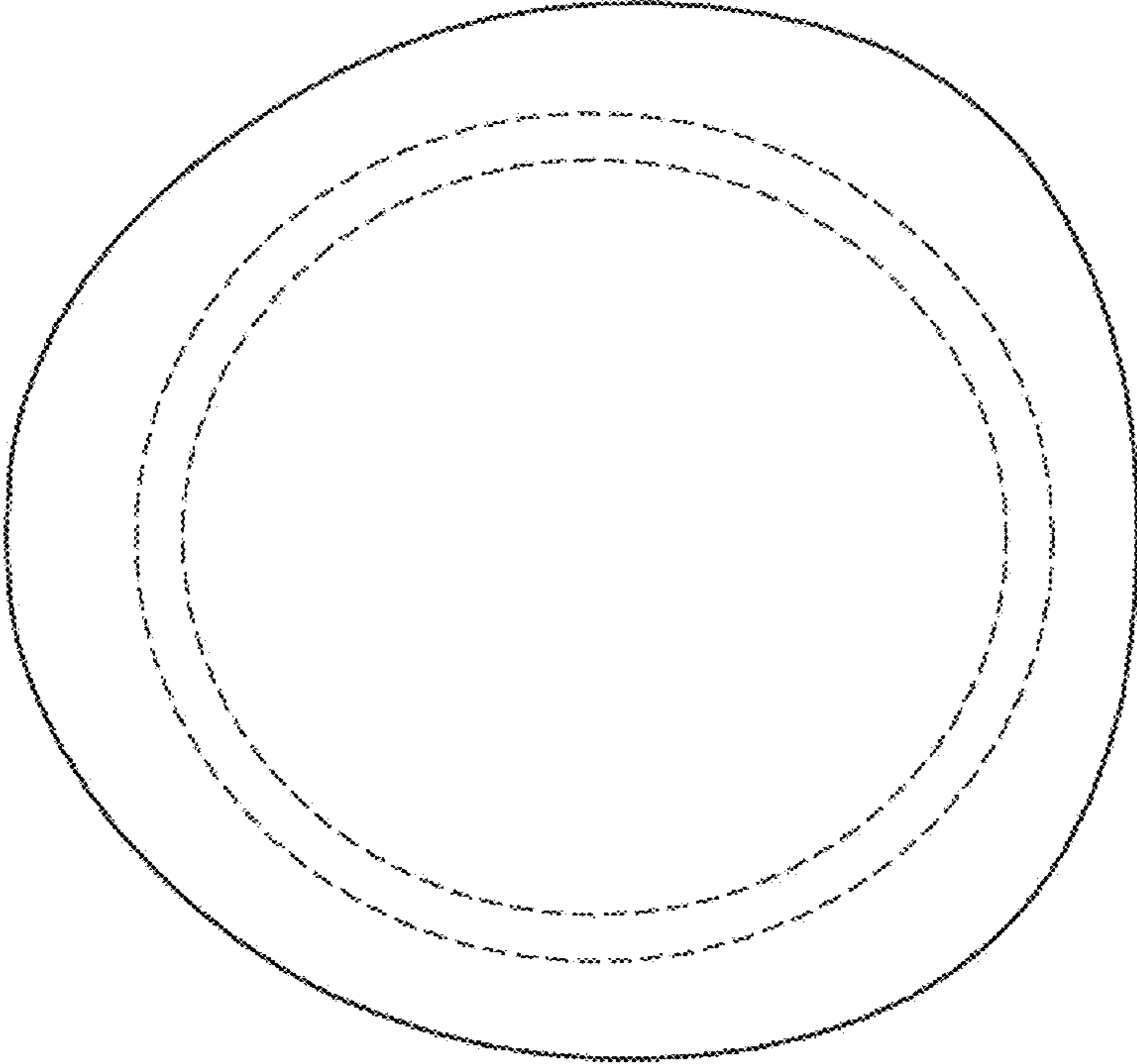

FIG. 6

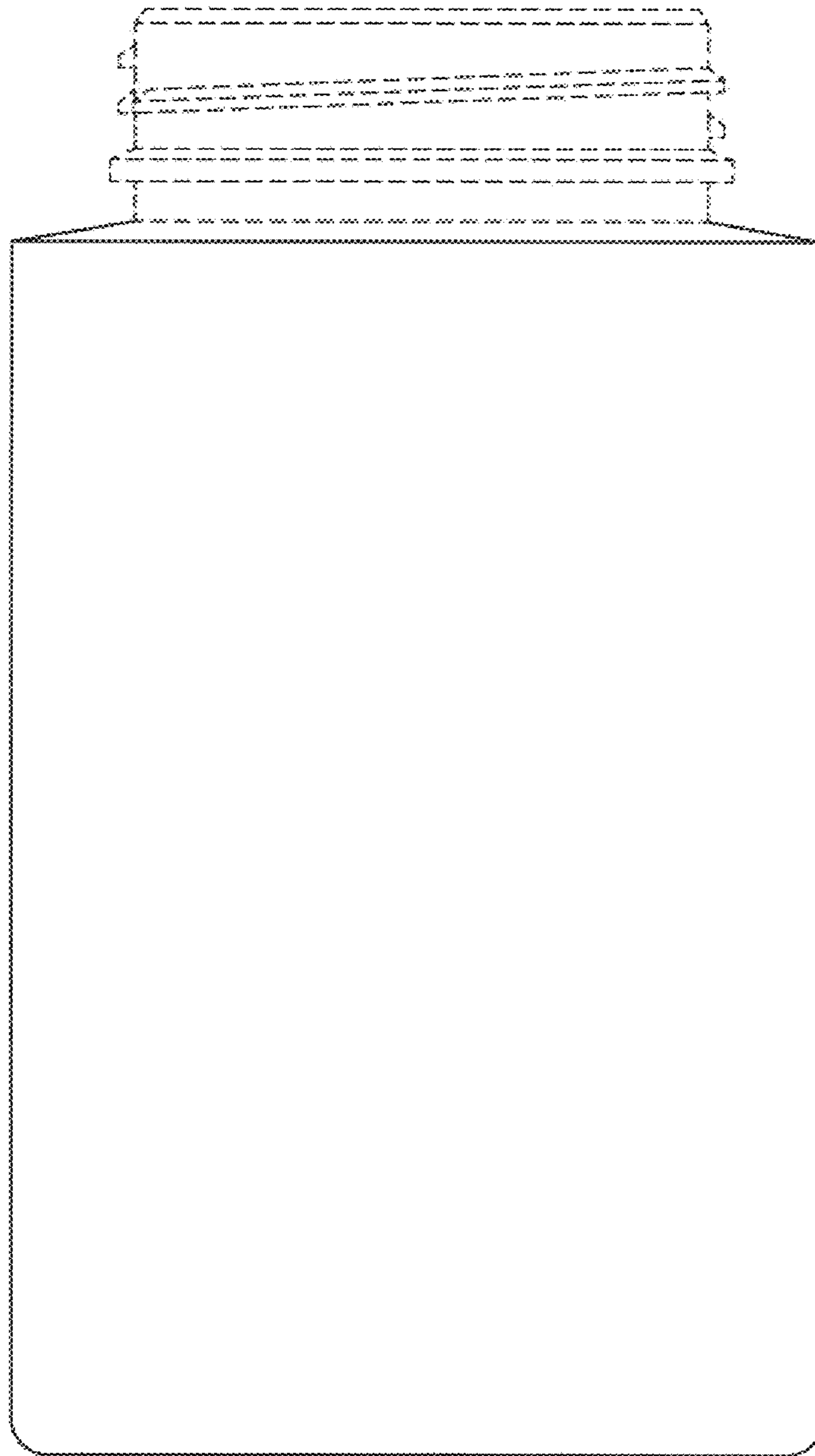

FIG. 7

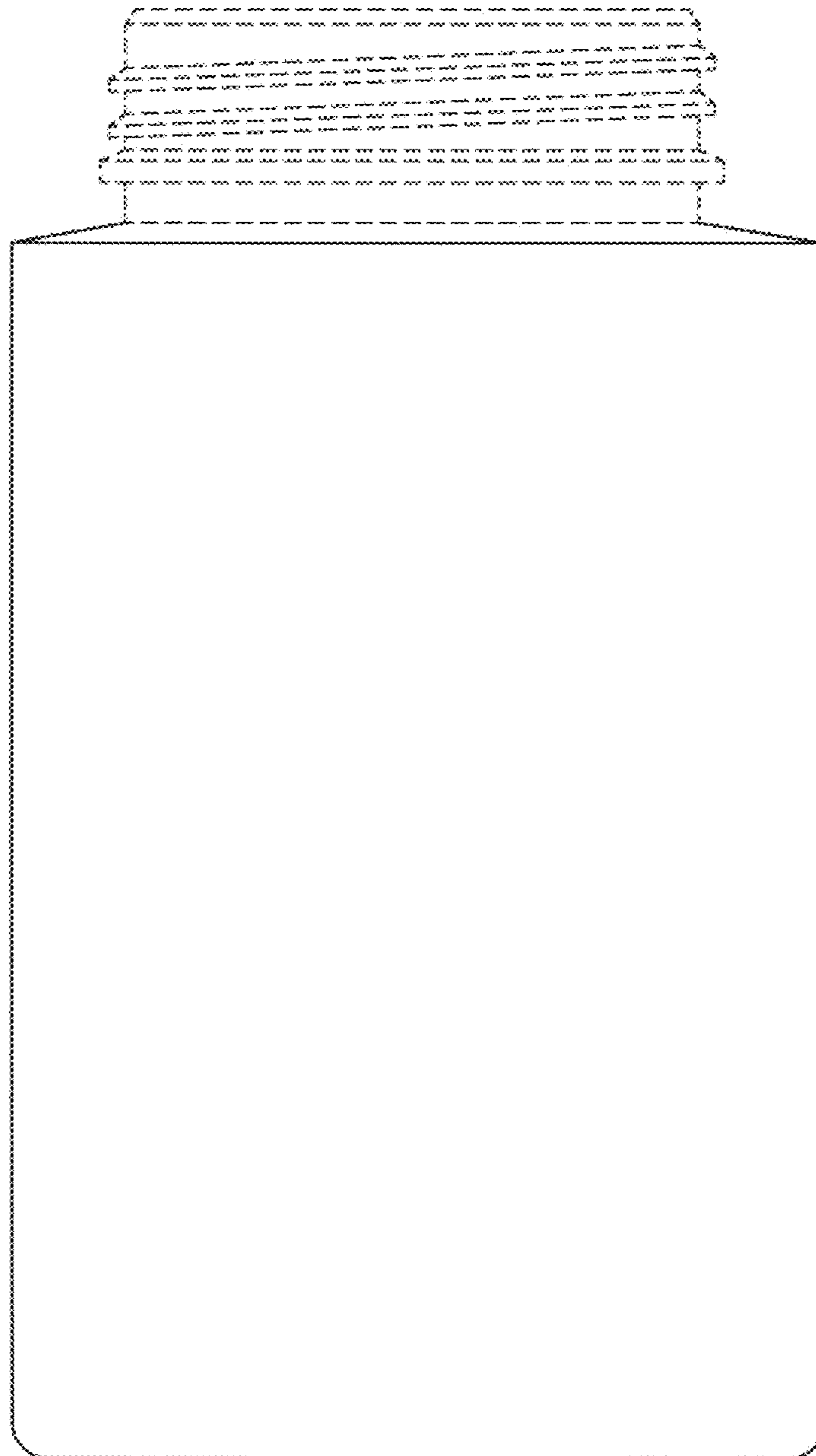

FIG. 8

