



US00D962053S

(12) **United States Design Patent**
Lowery et al.

(10) **Patent No.:** **US D962,053 S**
(45) **Date of Patent:** **** Aug. 30, 2022**

(54) **PACKAGING**

- (71) Applicant: **The Procter & Gamble Company**, Cincinnati, OH (US)
- (72) Inventors: **Jennifer Lynn Lowery**, Blue Ash, OH (US); **Robert Matthew Alexander, III**, San Francisco, CA (US); **Shin May Dominique Mao**, San Francisco, CA (US); **Heather Ann Beck**, San Francisco, CA (US)
- (73) Assignee: **The Procter & Gamble Company**, Cincinnati, OH (US)
- (**) Term: **15 Years**
- (21) Appl. No.: **29/765,442**
- (22) Filed: **Jan. 8, 2021**

Related U.S. Application Data

- (60) Continuation of application No. 29/715,348, filed on Dec. 2, 2019, now Pat. No. Des. 910,455, which is a (Continued)

(30) **Foreign Application Priority Data**

- Dec. 20, 2017 (WO) 5797101
- (51) **LOC (13) Cl.** **09-03**
- (52) **U.S. Cl.**
USPC **D9/432**
- (58) **Field of Classification Search**
USPC D9/655, 661, 662, 459, 456, 500, 501, D9/502, 503, 414, 415, 416, 418, 424,
(Continued)

(56) **References Cited**

U.S. PATENT DOCUMENTS

- D122,353 S * 9/1940 Blechman D5/37
- D132,923 S * 6/1942 McIntosh D9/662
(Continued)

OTHER PUBLICATIONS

Newborn Pampers Pure: Announced [Dec. 1, 2017 (online)]. Site Visited [May 21, 2022]. Available from Internet URL: <https://www.amazon.com/Pampers-Disposable-Hypoallergenic-Fragrance-Protection/dp/B077D66LZG?th=1>.*

(Continued)

Primary Examiner — Catherine S Posthauer

(74) *Attorney, Agent, or Firm* — Sarah M. DeCristofaro

(57) **CLAIM**

The ornamental design for packaging, as shown and described above.

DESCRIPTION

FIG. 1 is a perspective view of a first embodiment of a packaging, showing our new design;
 FIG. 2 is a front view thereof;
 FIG. 3 is a back view thereof;
 FIG. 4 is a right side view thereof;
 FIG. 5 is a left side view thereof;
 FIG. 6 is a top view thereof;
 FIG. 7 is a bottom view thereof.
 FIG. 8 is a perspective view of a second embodiment of a packaging, showing our new design;
 FIG. 9 is a front view thereof;
 FIG. 10 is a back view thereof;
 FIG. 11 is a right side view thereof;
 FIG. 12 is a left side view thereof;
 FIG. 13 is a top view thereof; and,
 FIG. 14 is a bottom view thereof.

The broken lines are shown for the purpose of illustrating parts of the article that form no part of the claimed design.

1 Claim, 14 Drawing Sheets

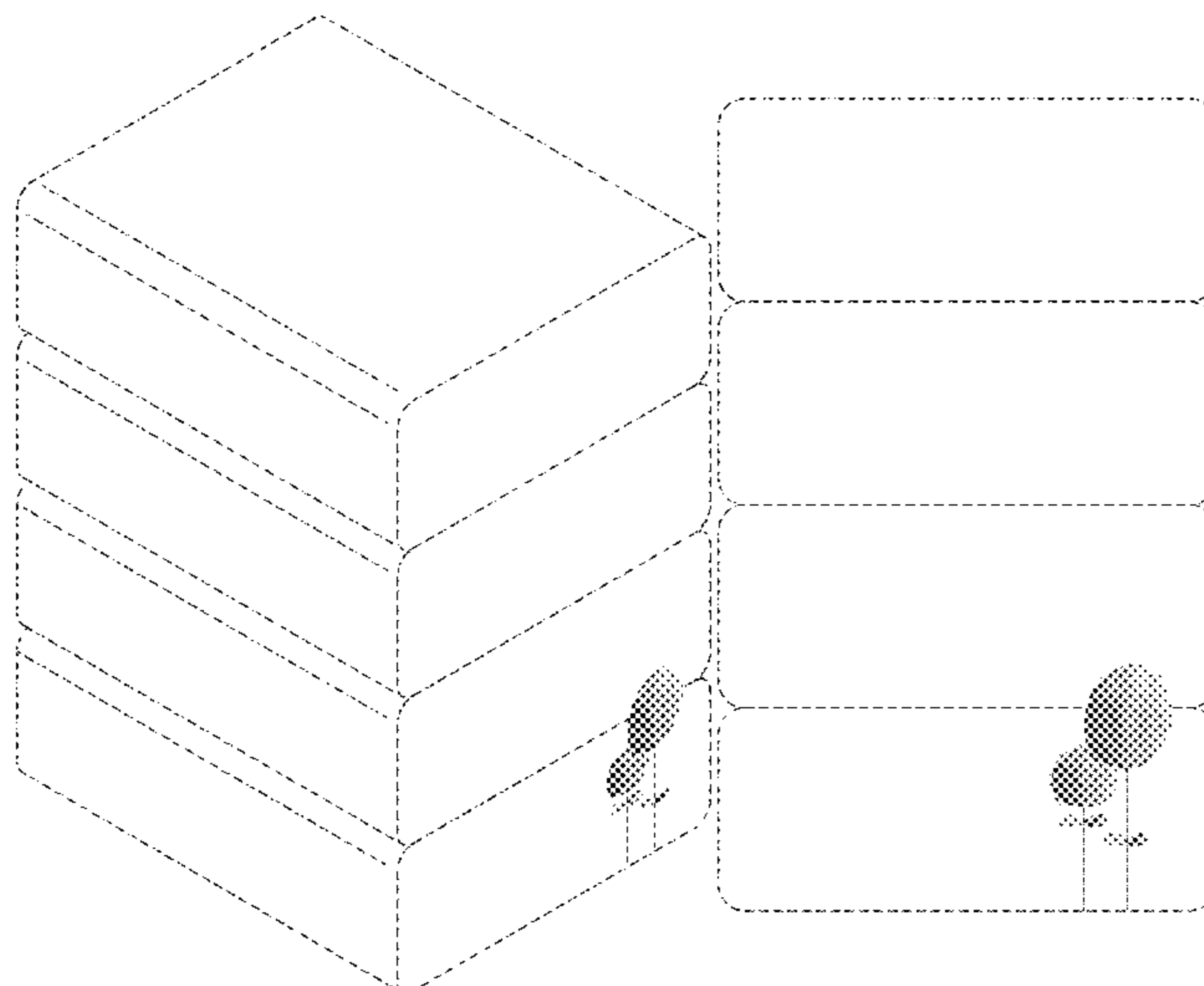

Related U.S. Application Data

division of application No. 29/650,529, filed on Jun. 7, 2018, now Pat. No. Des. 871,919.

(58) **Field of Classification Search**

USPC D9/430, 432, 433, 737, 748, 750, 751, D9/757, 759, 761, 762; D7/300, 317, D7/321, 387, 388.391, 392, 396.1, 396.6, D7/397, 398, 401.1, 403, 509, 538, 610, D7/619.1, 629, 672, 677, 601, 602, 624.1, D7/705, 708; D5/20, 25, 32, 37; D20/10, 11, 26; D14/492

CPC B65D 5/00; B65D 5/001; B65D 5/0015; B65D 5/0227-0254; B65D 5/18; B65D 5/38; B65D 5/40; B65D 5/2033; B65D 5/40024; B65D 5/6605; B65D 1/22; B65D 1/24; B65D 1/34; B65B 25/001; B65B 5/068; B65B 7/2878; A23L 15/30

See application file for complete search history.

(56) **References Cited**

U.S. PATENT DOCUMENTS

D145,044 S * 6/1946 Park D5/37
 3,785,254 A 1/1974 Mann
 D382,476 S 8/1997 Bell
 D411,798 S * 7/1999 Suzuki D9/415
 D421,903 S * 3/2000 Craker D9/433
 D494,862 S 8/2004 Sisinni
 D526,895 S 8/2006 Sisinni
 D562,695 S * 2/2008 Crombie D9/601
 D588,909 S 3/2009 Kim
 D588,910 S 3/2009 Kim
 D589,792 S * 4/2009 Clabough D9/434
 D621,167 S * 8/2010 Watson, Jr. D5/62
 D638,629 S * 5/2011 Kiely D5/32
 D644,245 S * 8/2011 Matas D14/492
 D648,348 S * 11/2011 Matas D14/492
 D695,125 S 12/2013 Larson et al.
 D696,135 S 12/2013 Larson et al.
 D696,590 S 12/2013 Larson et al.

D696,960 S 1/2014 Larson et al.
 D723,925 S * 3/2015 Klarin D9/500
 D723,926 S 3/2015 Klarin
 D725,479 S 3/2015 Ajichi
 D726,025 S * 4/2015 Somers D9/667
 D729,069 S 5/2015 Ajichi
 D730,741 S 6/2015 Reinmuth
 D733,571 S * 7/2015 Keating D9/600
 D739,742 S * 9/2015 Klarin D9/500
 D739,743 S * 9/2015 Klarin D9/500
 D742,244 S 11/2015 Allen
 D751,917 S 3/2016 Reinmuth
 D752,981 S * 4/2016 Dumville D9/499
 D772,072 S 11/2016 Klopp
 D801,799 S 11/2017 Boston
 D807,741 S * 1/2018 Heidel D9/434
 D807,742 S * 1/2018 Heidel D9/434
 D807,743 S * 1/2018 Heidel D9/434
 D808,261 S * 1/2018 Heidel D9/434
 D808,262 S * 1/2018 Heidel D9/434
 D808,800 S * 1/2018 Heidel D9/434
 D818,371 S 5/2018 Hablutzel
 D863,957 S * 10/2019 Riffe D9/434
 D871,210 S * 12/2019 Clifton D9/432
 D871,919 S 1/2020 Lowery et al.
 D901,189 S * 11/2020 Choi D5/37
 D904,037 S * 12/2020 Choi D5/37
 D910,455 S 2/2021 Lowery et al.
 D910,456 S 2/2021 Lowery et al.
 D926,310 S * 7/2021 Canfield D24/126
 D929,460 S * 8/2021 Dautova D14/492
 D942,268 S * 2/2022 Hinkle D9/433
 D945,261 S * 3/2022 Marotti D9/432
 11,286,084 B1 * 3/2022 Love A47F 7/283
 D947,664 S * 4/2022 De Baschmakoff D9/414
 2021/0047099 A1 * 2/2021 Bulls, Jr. B65B 5/04
 2021/0053716 A1 * 2/2021 Coleman, Jr. B65D 5/0227

OTHER PUBLICATIONS

Unpublished U.S. Appl. No. 29/765,440, filed Jan. 8, 2021, to Jennifer Lynn Lowery et al.
 All Office Actions; U.S. Appl. No. 29/765,440.

* cited by examiner

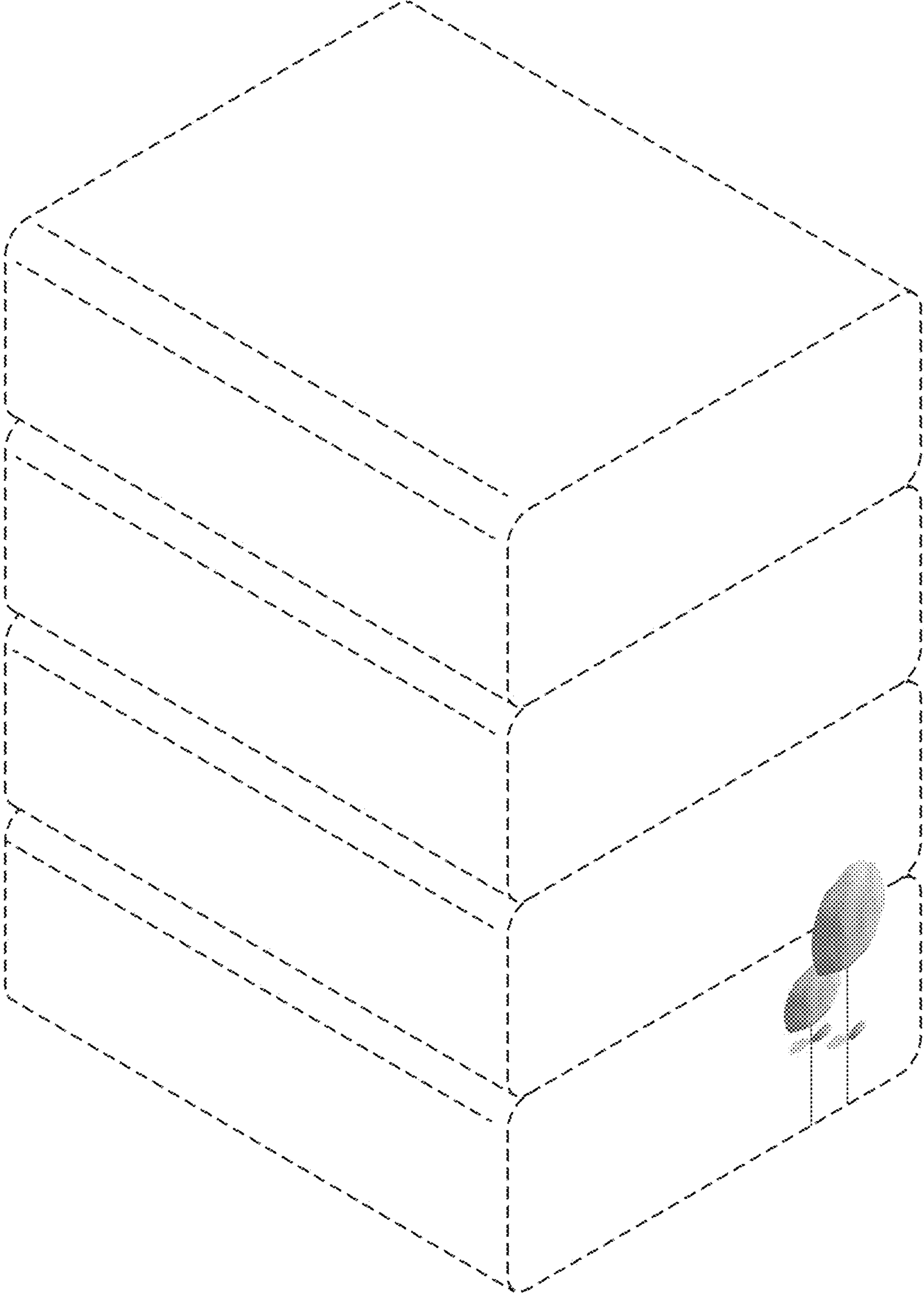

Fig. 1

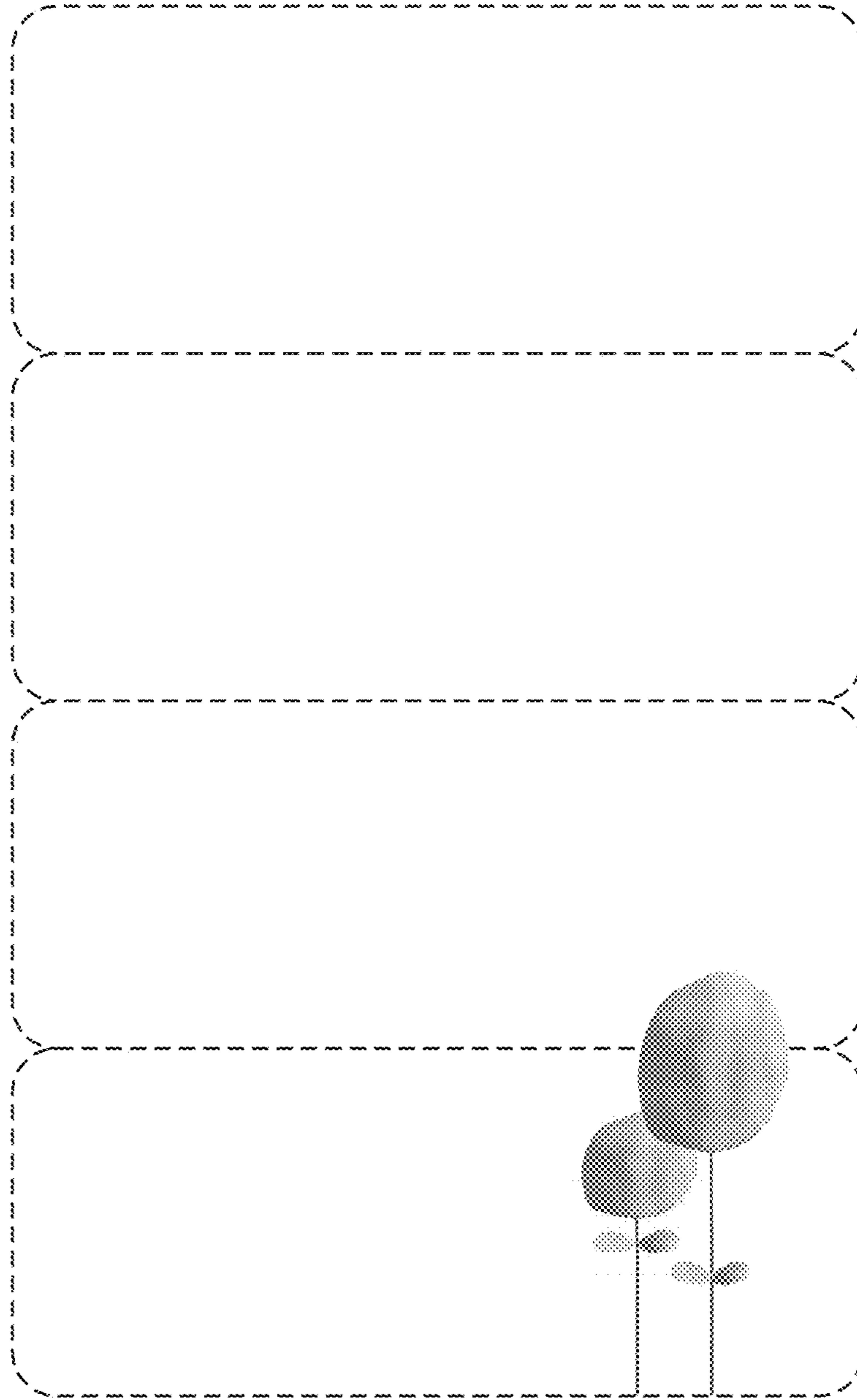

Fig. 2

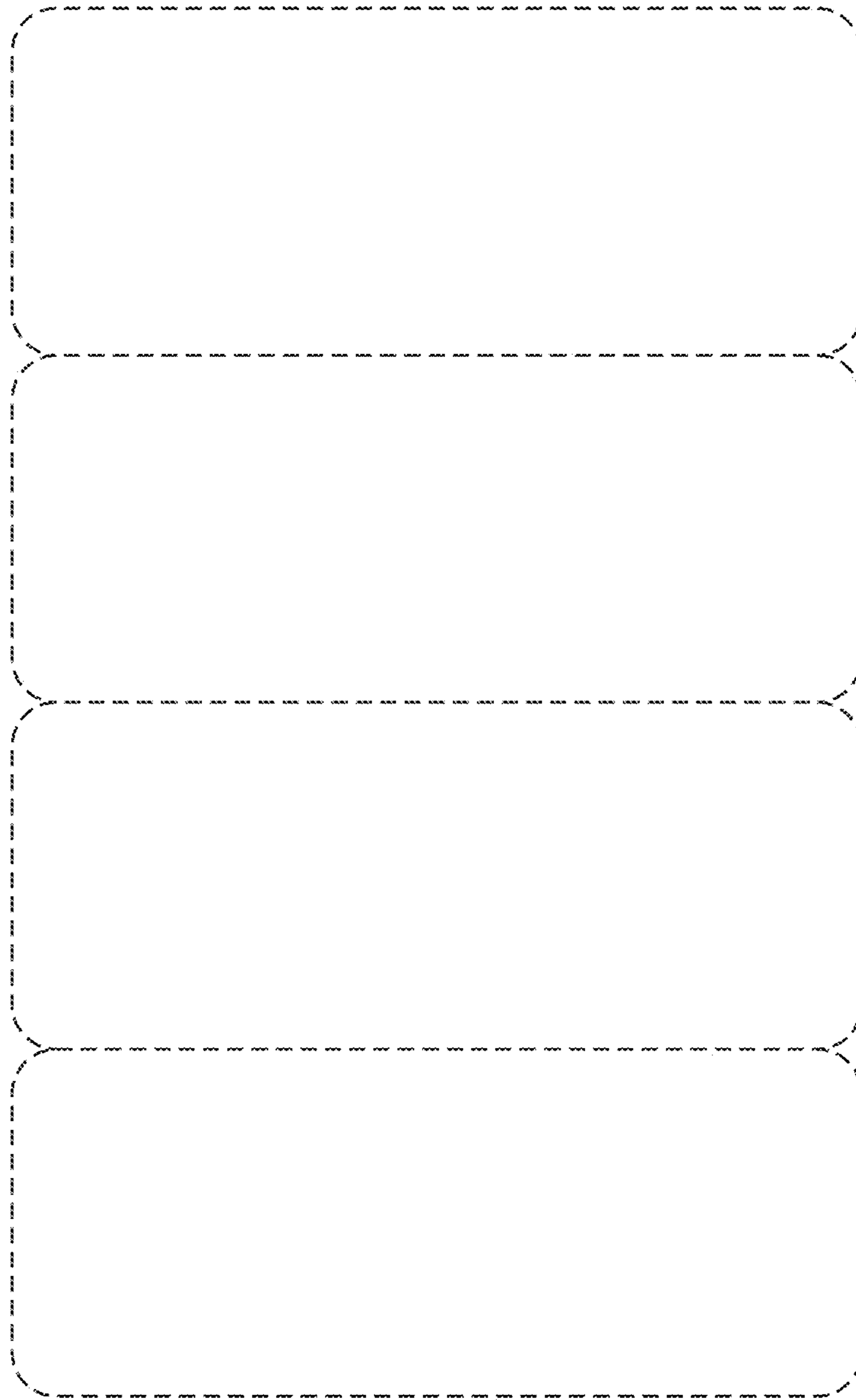

Fig. 3

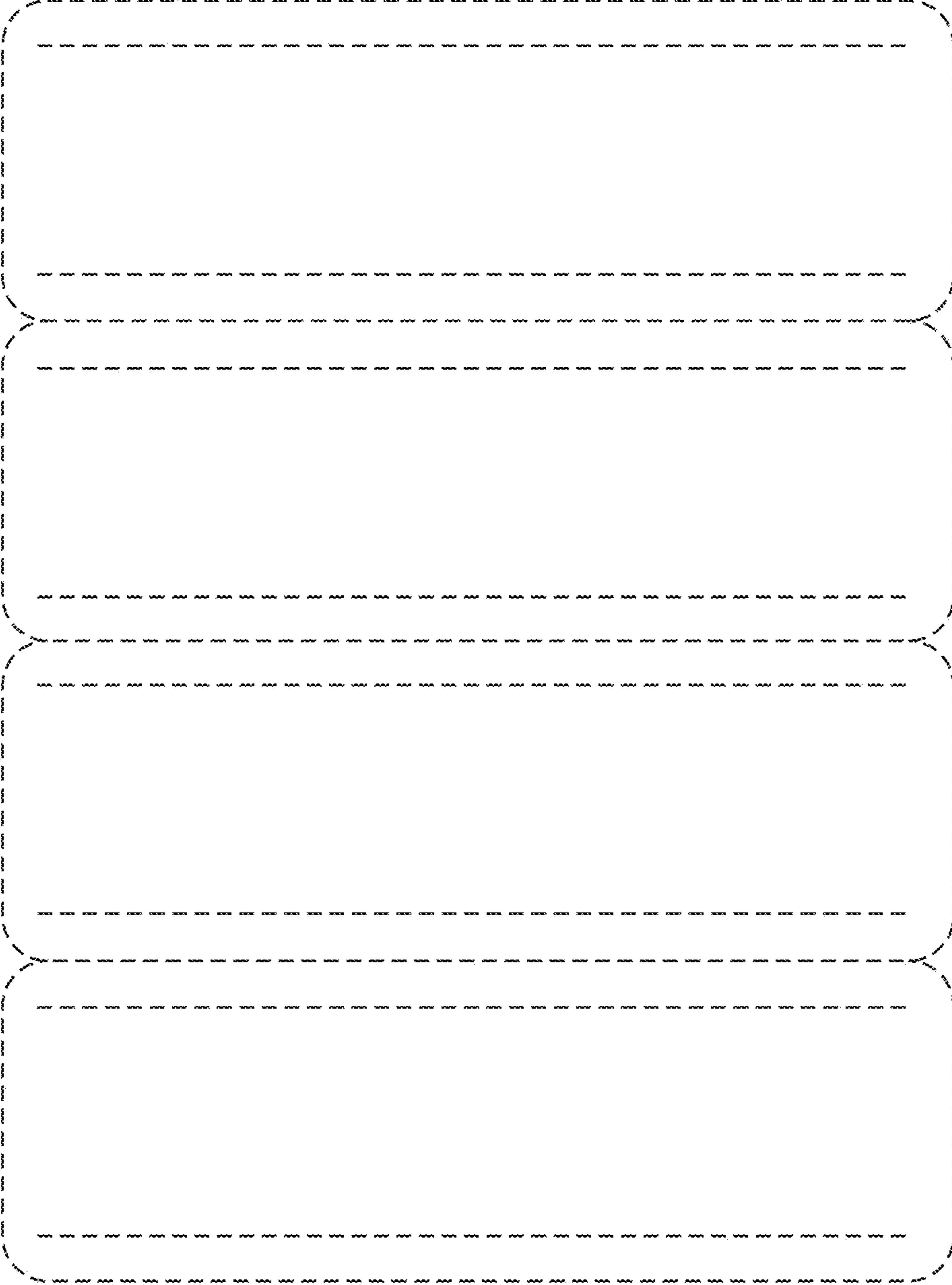

Fig. 4

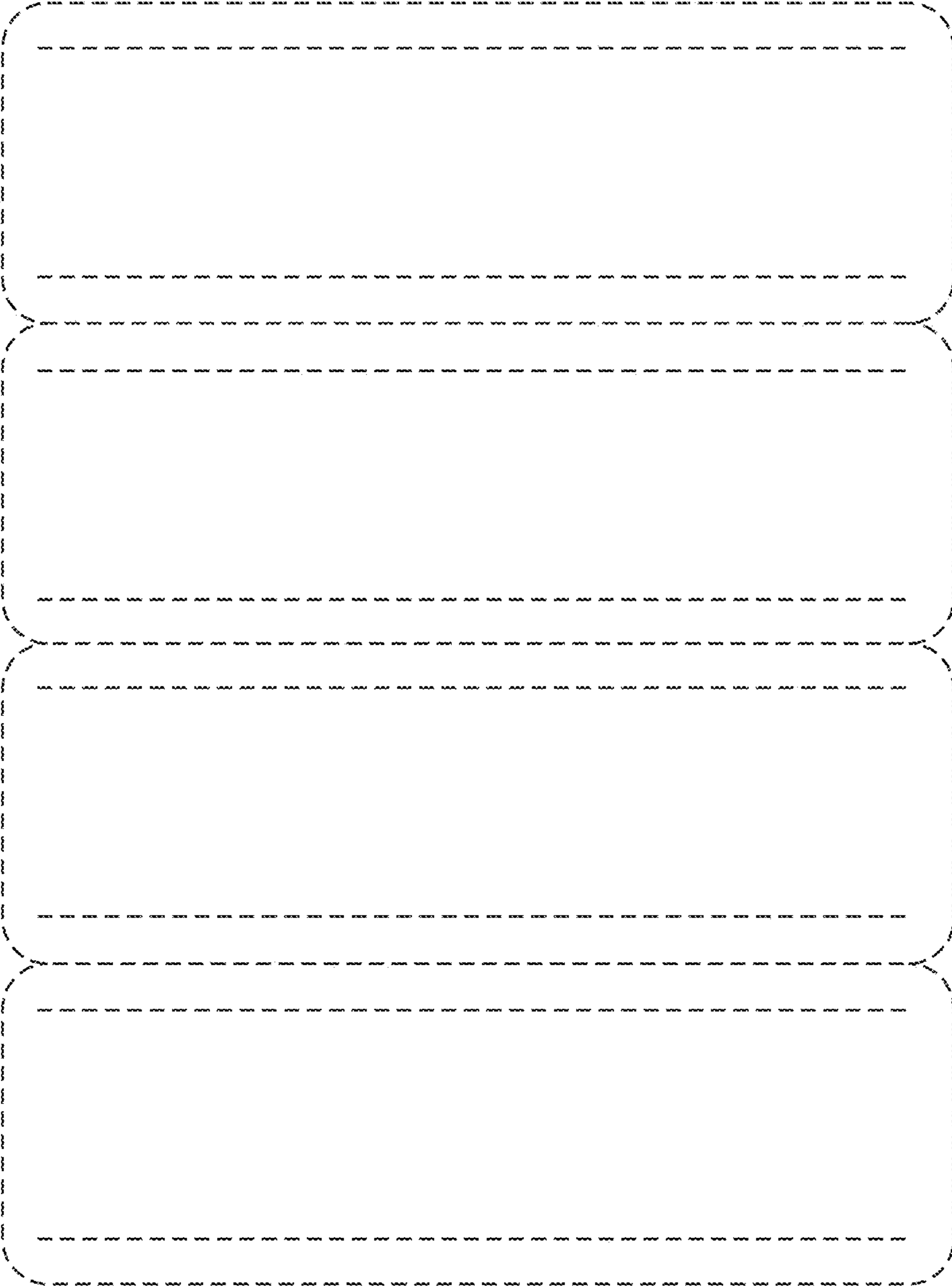

Fig. 5

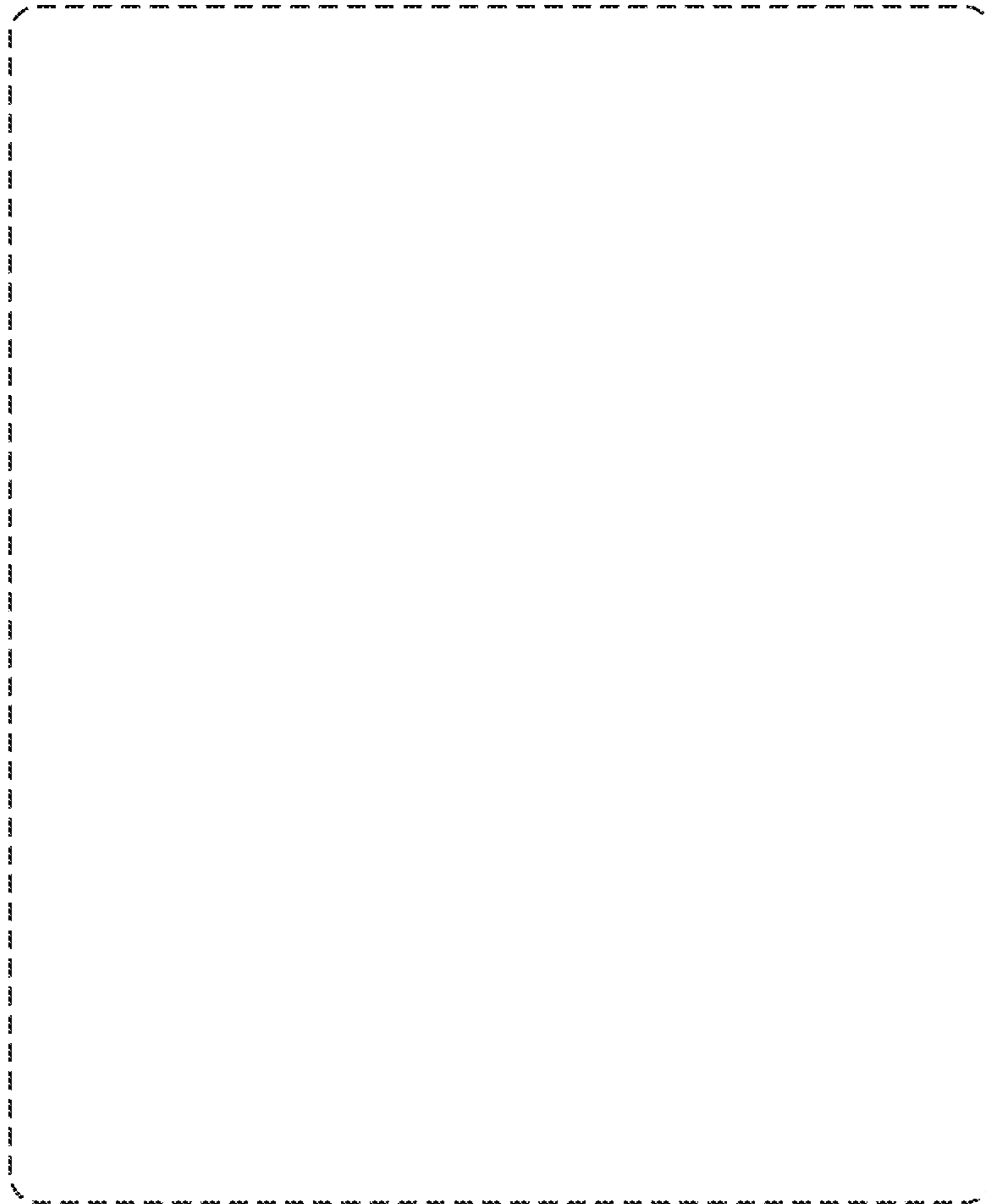

Fig. 6

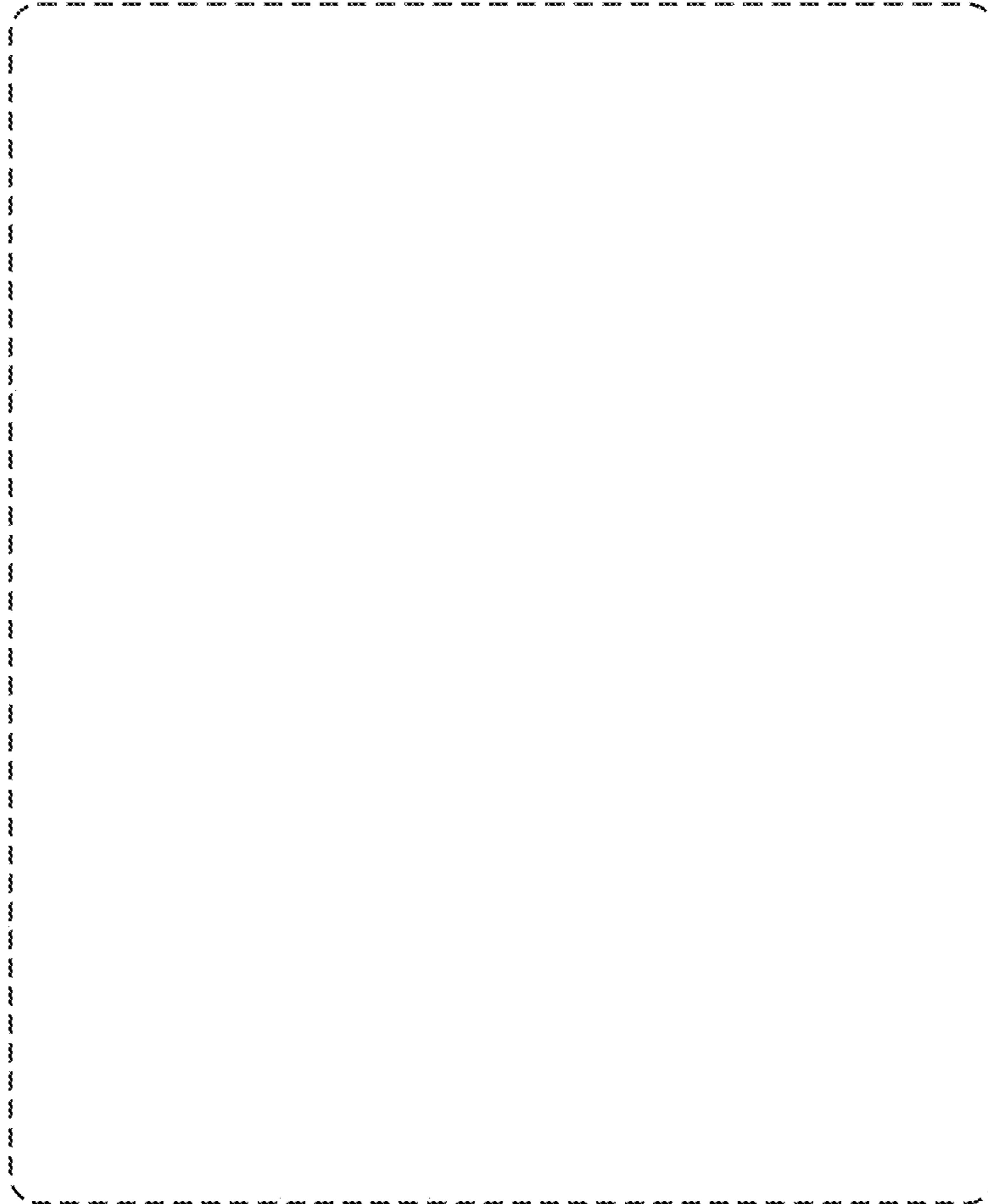

Fig. 7

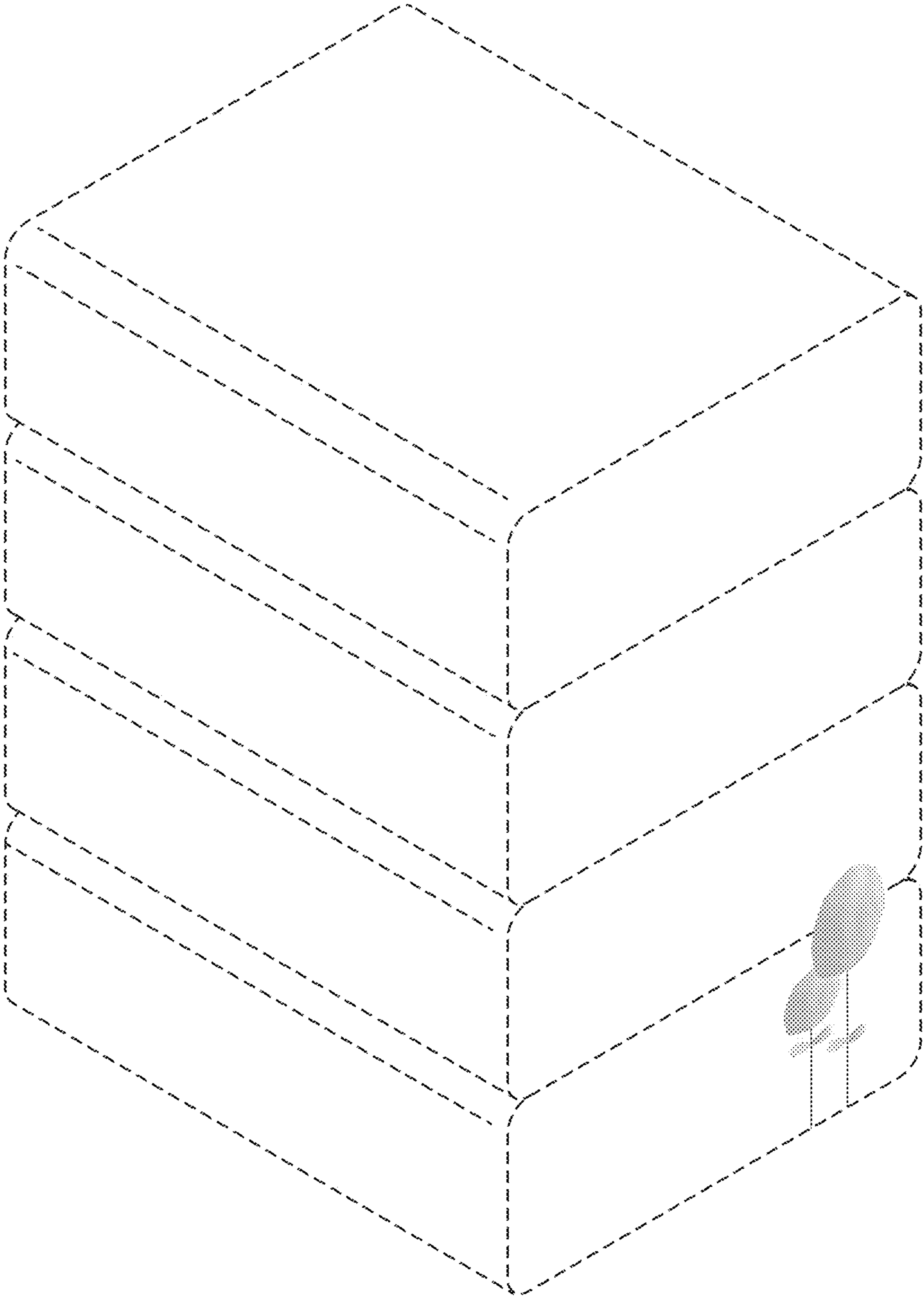

Fig. 8

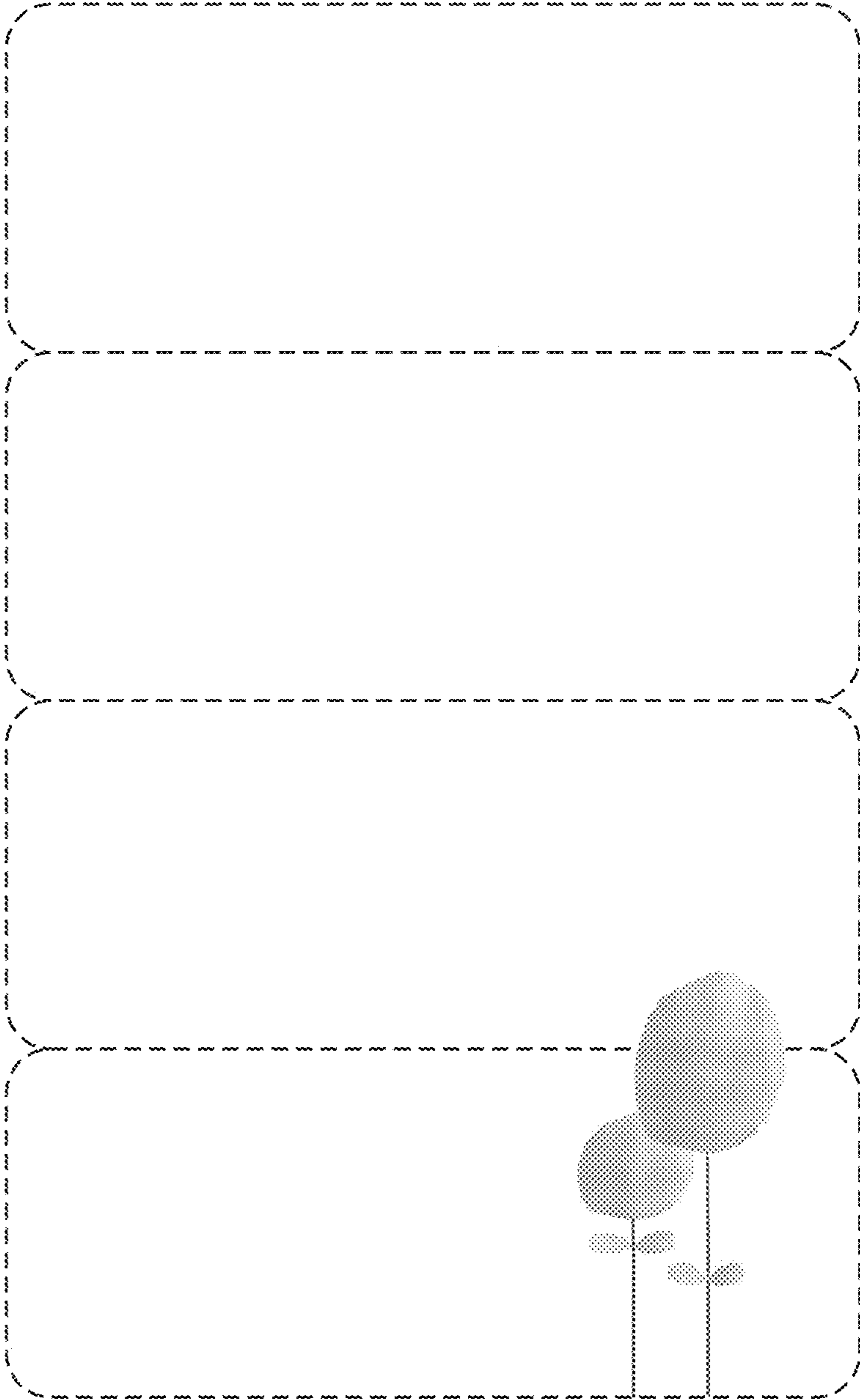

Fig. 9

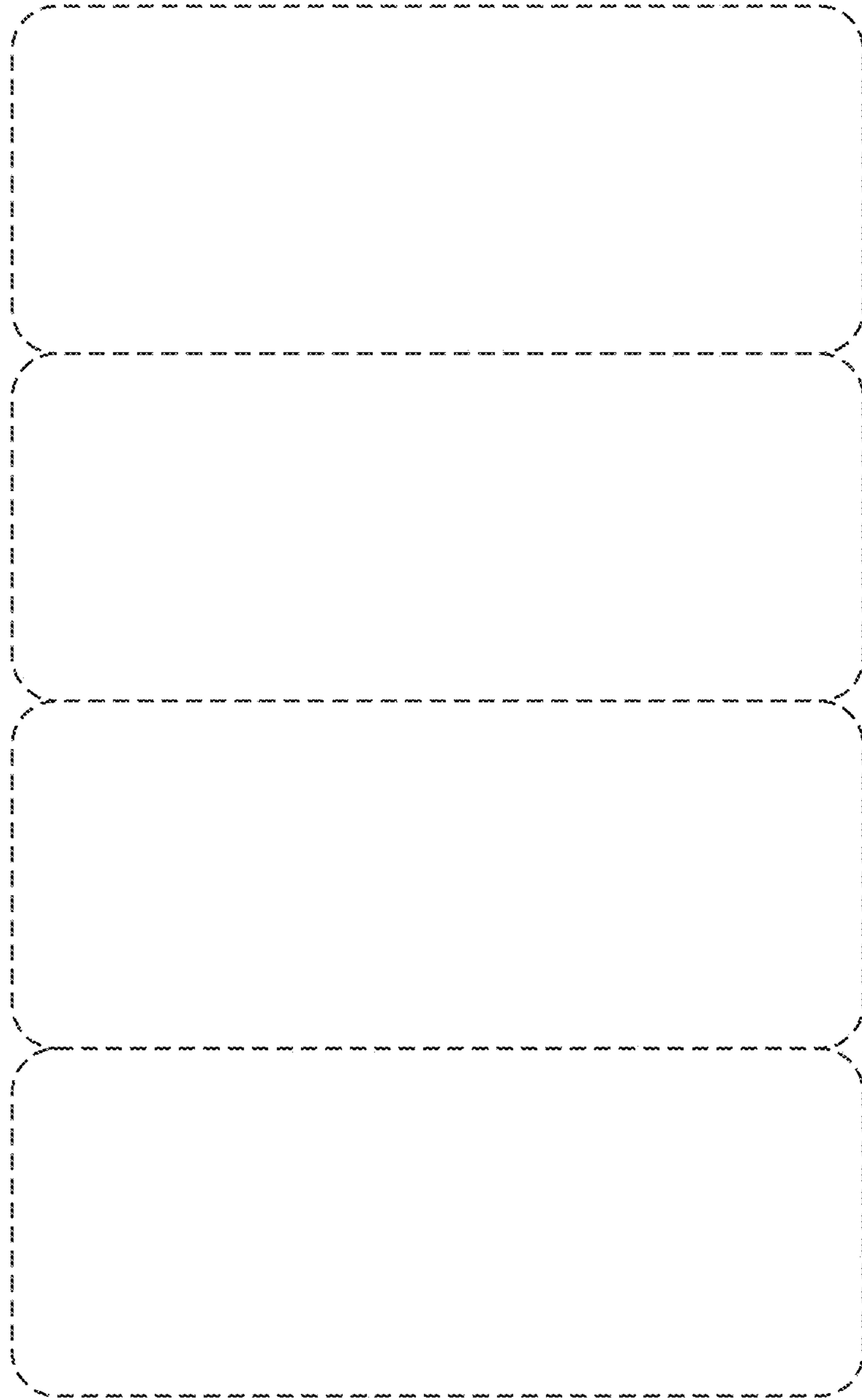

Fig. 10

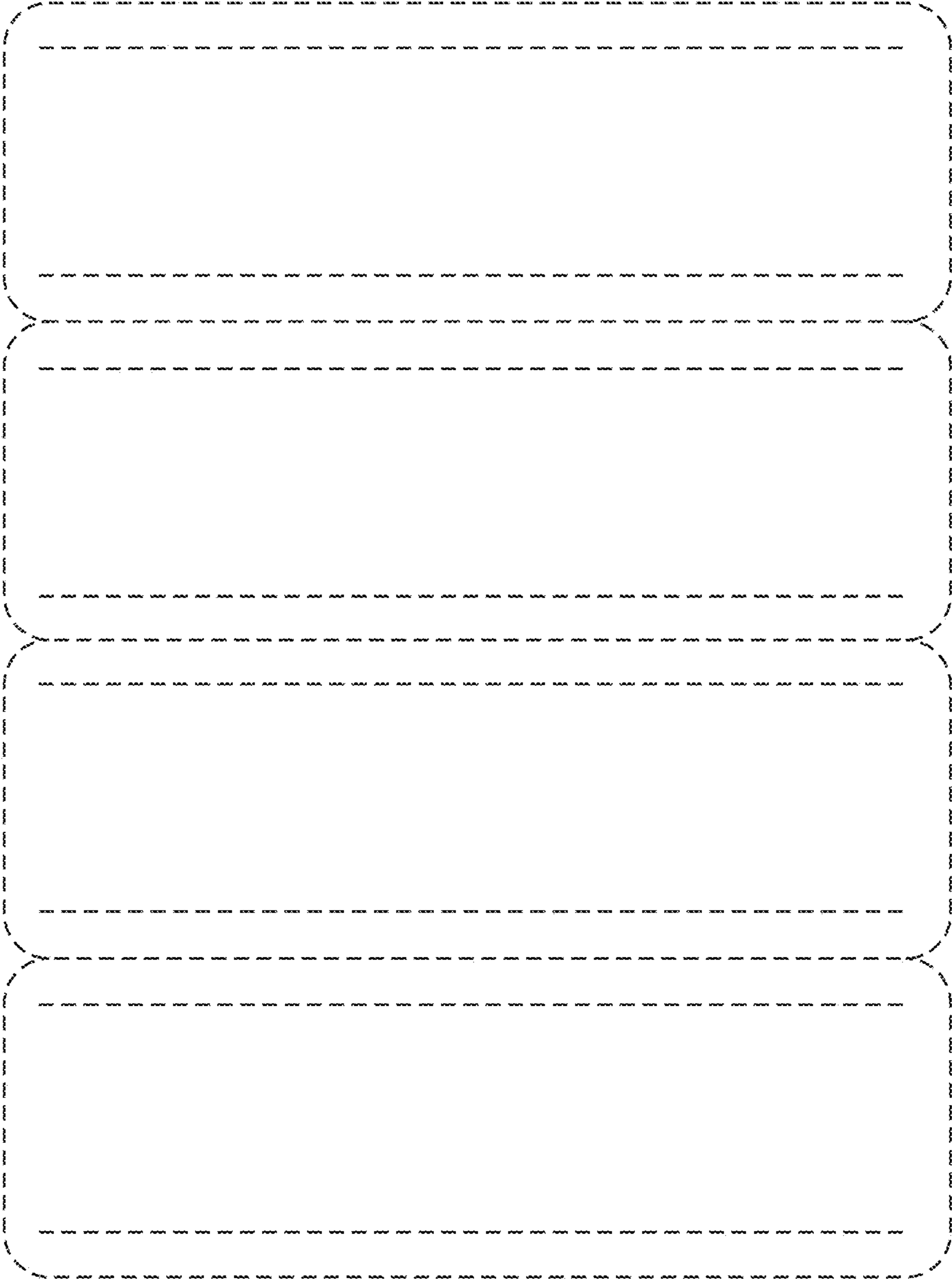

Fig. 11

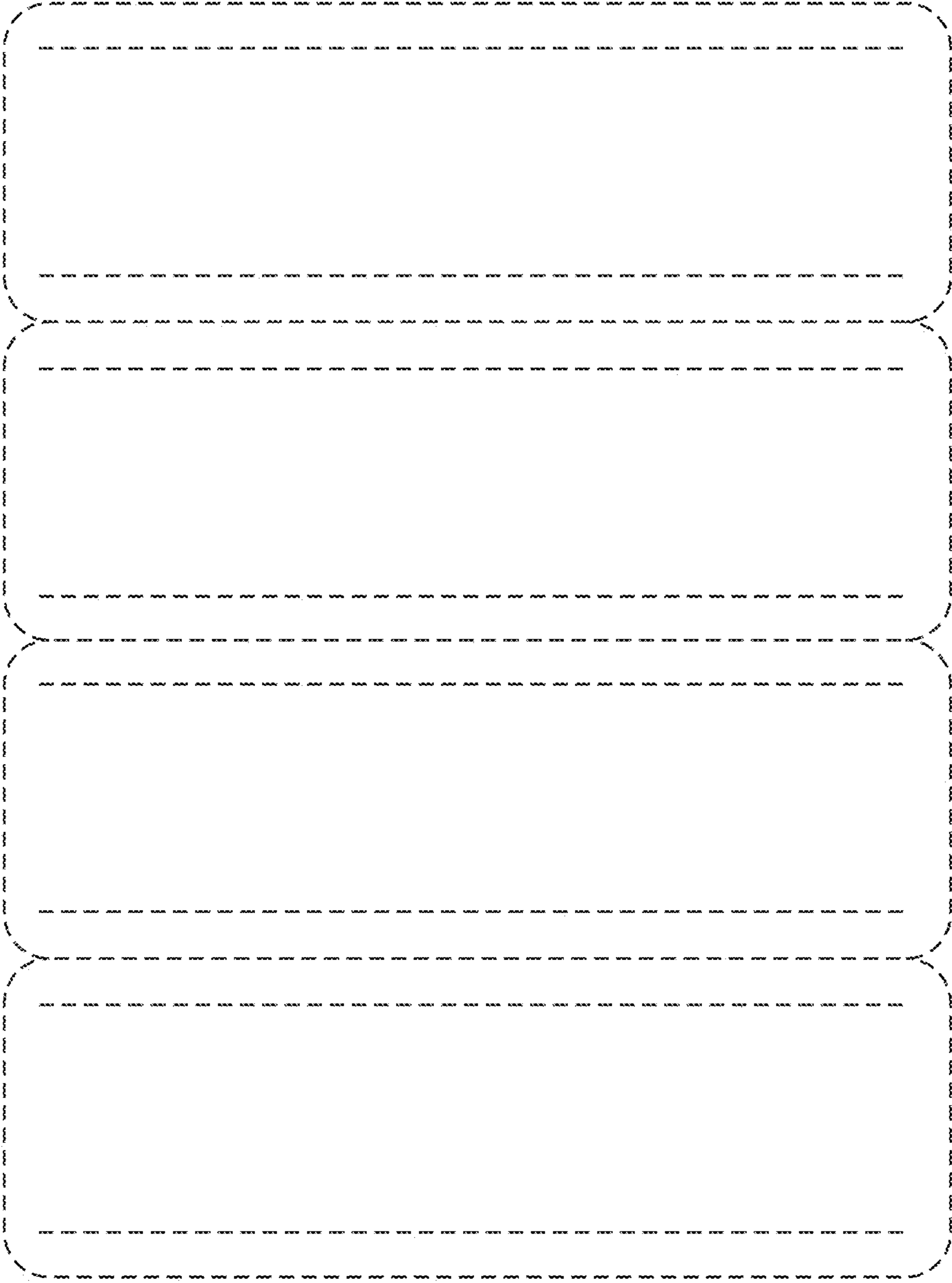

Fig. 12

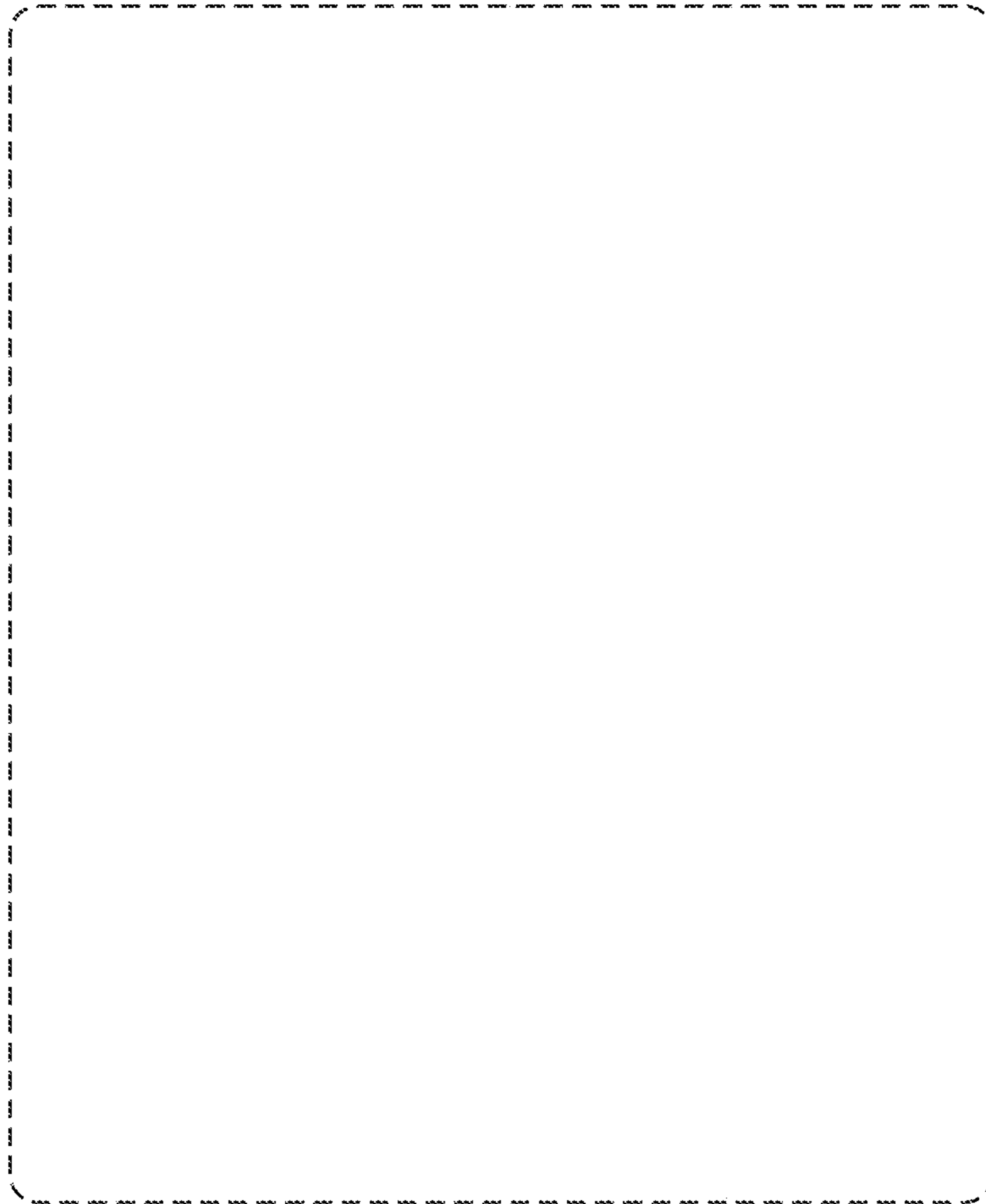

Fig. 13

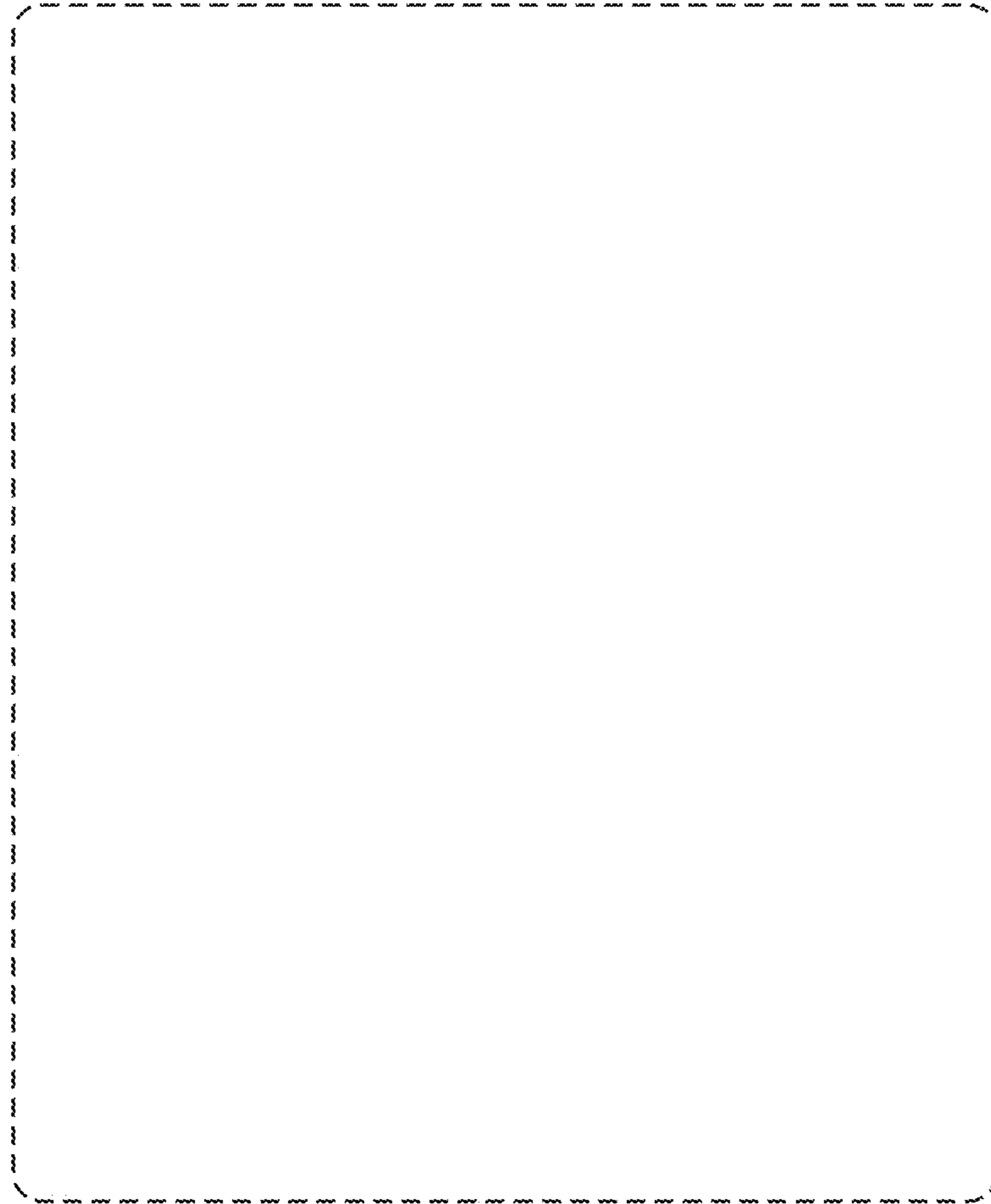

Fig. 14