



US00D961938S

(12) **United States Design Patent**
Arakaki

(10) **Patent No.:** **US D961,938 S**

(45) **Date of Patent:** **** Aug. 30, 2022**

- (54) **LONG-BRISTLED BRUSH**
- (71) Applicant: **Mark Mitsuo Arakaki**, Honolulu, HI (US)
- (72) Inventor: **Mark Mitsuo Arakaki**, Honolulu, HI (US)
- (**) Term: **15 Years**
- (21) Appl. No.: **29/755,740**
- (22) Filed: **Oct. 22, 2020**
- (51) **LOC (13) Cl.** **04-01**
- (52) **U.S. Cl.**
USPC **D4/129**
- (58) **Field of Classification Search**
USPC D4/100, 102, 114, 115, 116, 117, 118, D4/119, 120, 121, 122, 123, 124, 125, D4/126, 127, 128, 129, 130, 131, 132, D4/133, 134, 135, 136, 137, 138, 199; D3/232, 233, 234, 235, 236, 237, 238, D3/239, 240, 241, 242, 243, 244, 245, D3/246
CPC .. A46B 3/12; A46B 5/02; A46B 5/021; A46B 2200/20; A46B 2200/202; A46B 2200/3073; A46B 2200/304
See application file for complete search history.

- 3,029,455 A * 4/1962 Siculan A47L 13/52 15/171
- D218,387 S * 8/1970 Whitaker D4/118
- D239,480 S * 4/1976 Thomas D4/118
- D278,390 S * 4/1985 Bailey D4/130
- D308,920 S * 7/1990 Murphy D4/114
- D366,150 S * 1/1996 Suchomel D4/116
- D456,618 S 5/2002 Libman

(Continued)

FOREIGN PATENT DOCUMENTS

EM 000359658-0004 * 11/2005

OTHER PUBLICATIONS

4055 Bristles Large Angle Broom with Metal Handle, Retrieved from Internet, Retrieved on Mar. 15, 2019 <URL: <http://ianicoinc.com/standard-large-angle-broom-with-metal-handle>>.

(Continued)

Primary Examiner — Karen E Eldridge Powers

(57) **CLAIM**

The ornamental design for a long-bristled brush, as shown and described.

DESCRIPTION

FIG. 1 is a front-top-left perspective view of a long-bristled brush showing my new design;
FIG. 2 is a front-top-right perspective view of a long-bristled brush showing my new design;
FIG. 3 is a front-plan view thereof;
FIG. 4 is a back-plan view thereof;
FIG. 5 is a left elevation view thereof;
FIG. 6 is a right elevation view thereof;
FIG. 7 is a top plan view thereof; and,
FIG. 8 is a bottom plan view thereof.
The broken line showing the bristles in FIGS. 1-8 are included for the purpose of showing environmental structure and form no part of the claimed design.

1 Claim, 8 Drawing Sheets

(56) **References Cited**

U.S. PATENT DOCUMENTS

- 179,223 A * 6/1876 Rosenthal 15/204
- 182,406 A * 9/1876 Bowditch 15/204
- D29,613 S * 11/1898 Loveless D4/199
- 871,494 A * 11/1907 Foss 15/204
- D53,415 S * 6/1919 Holden D8/336
- D72,400 S * 4/1927 Wojciechowski D3/240
- D102,306 S * 12/1936 Felmann D3/239
- D106,564 S * 10/1937 Goldsmith D3/243
- D114,848 S * 5/1939 Lewis D3/240
- D128,557 S * 7/1941 Pichel D3/246
- D158,250 S * 4/1950 Cosby, Jr. D4/127

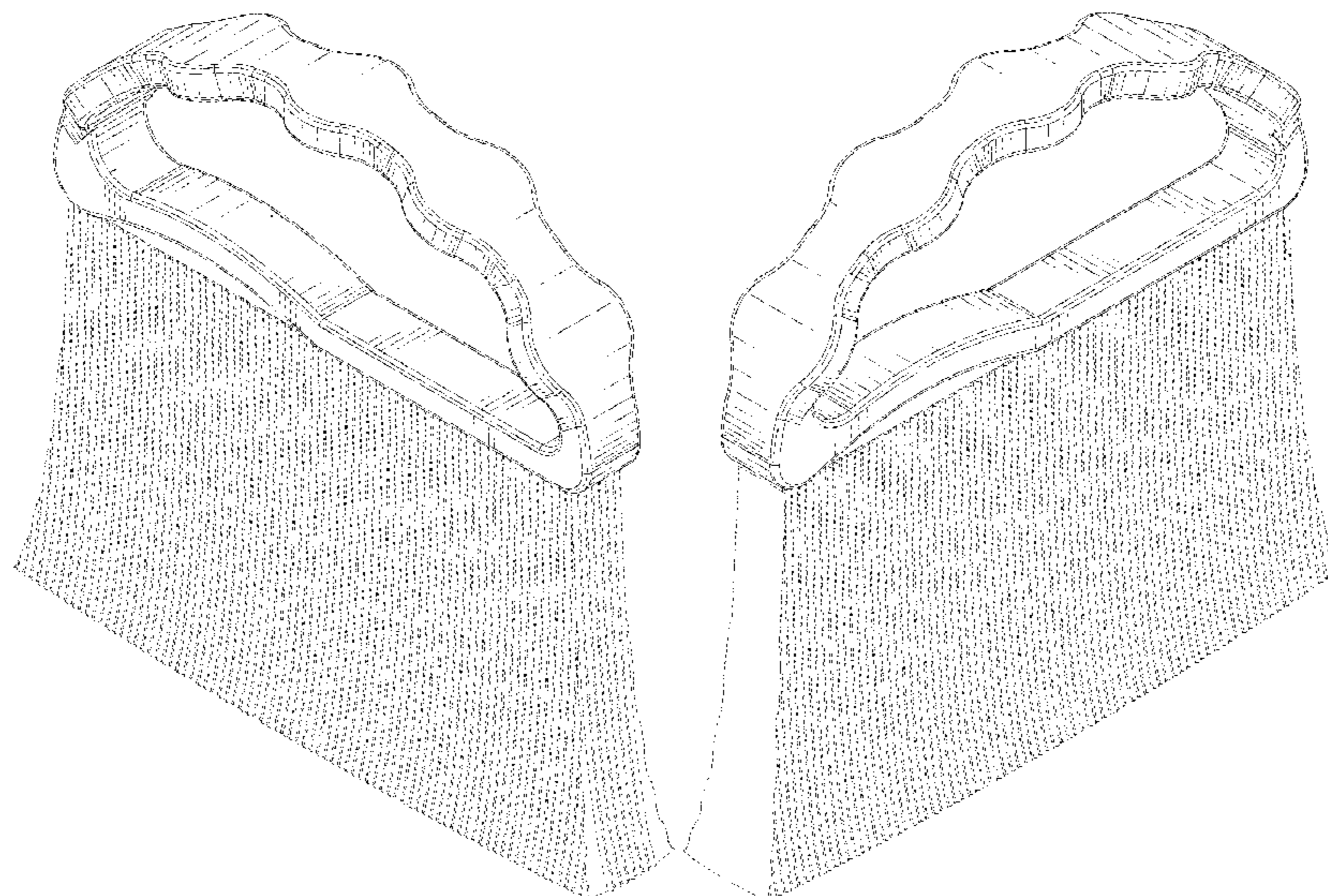

(56)

References Cited

U.S. PATENT DOCUMENTS

6,793,434 B1 9/2004 Olson
6,877,181 B2 * 4/2005 Laux A46B 15/00
D32/42
D632,083 S * 2/2011 Vilain D4/135
D659,387 S * 5/2012 Lucido D8/336
D707,043 S * 6/2014 Ash D4/114
D849,411 S * 5/2019 Zemel D4/138
D933,970 S * 10/2021 Lin D4/124
2022/0031054 A1 * 2/2022 Arakaki A46B 9/02

OTHER PUBLICATIONS

Hyde 46838 Stainless Steel Wire Scrub Brush, 8-inch, Maxxgrip Pro, Retrieved from Internet, Retrieved on Mar. 15, 2019 <URL: <https://www.amazon.com/Hyde-Tools-46838-MaxxGrip-Stainless/dp/B001VEG1BG>>.

Mini Plastic Hand Kitchen Dustpan Brush Broom Set Soft Keyboard Cleaner Sweeper, Retrieved from Internet, Retrieved on Mar. 15, 2019 <URL: <https://www.walmart.com/ip/Mini-Plastic-Hand-Kitchen-Dustpan-Brush-Soft-Cleaning-Sweeper-Dust-Pan-Green/302964730>>.

* cited by examiner

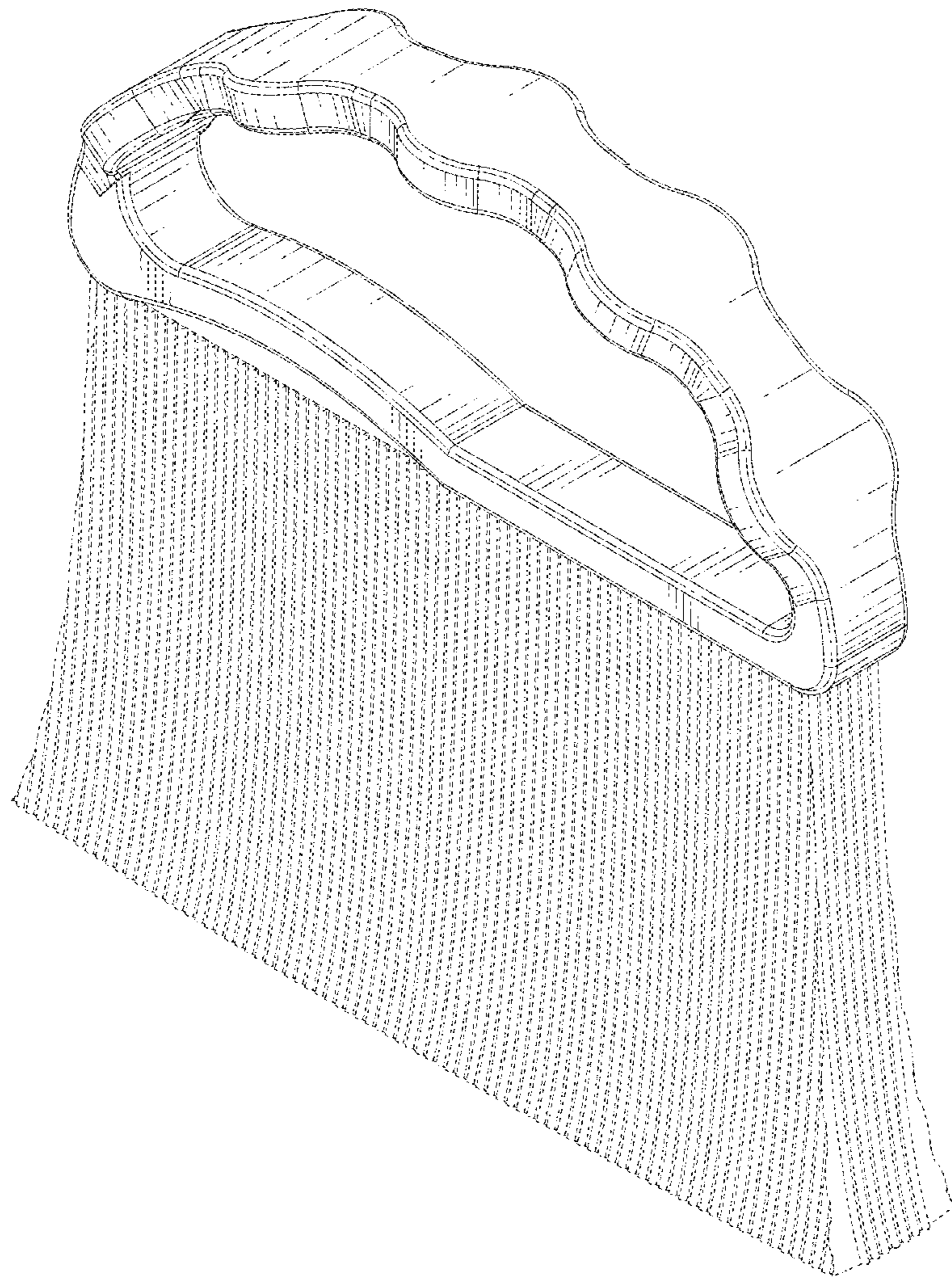

FIG. 1

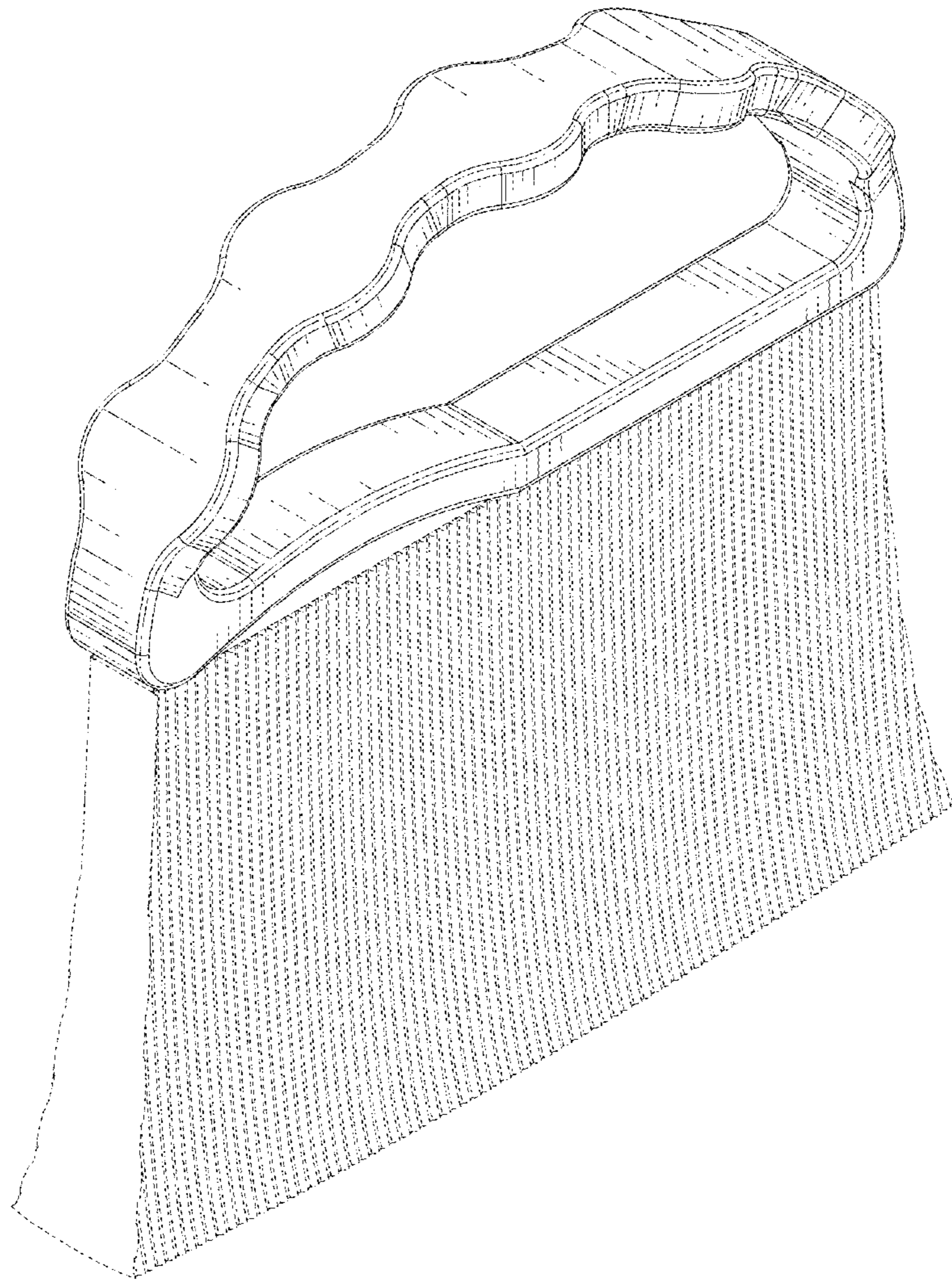

FIG. 2

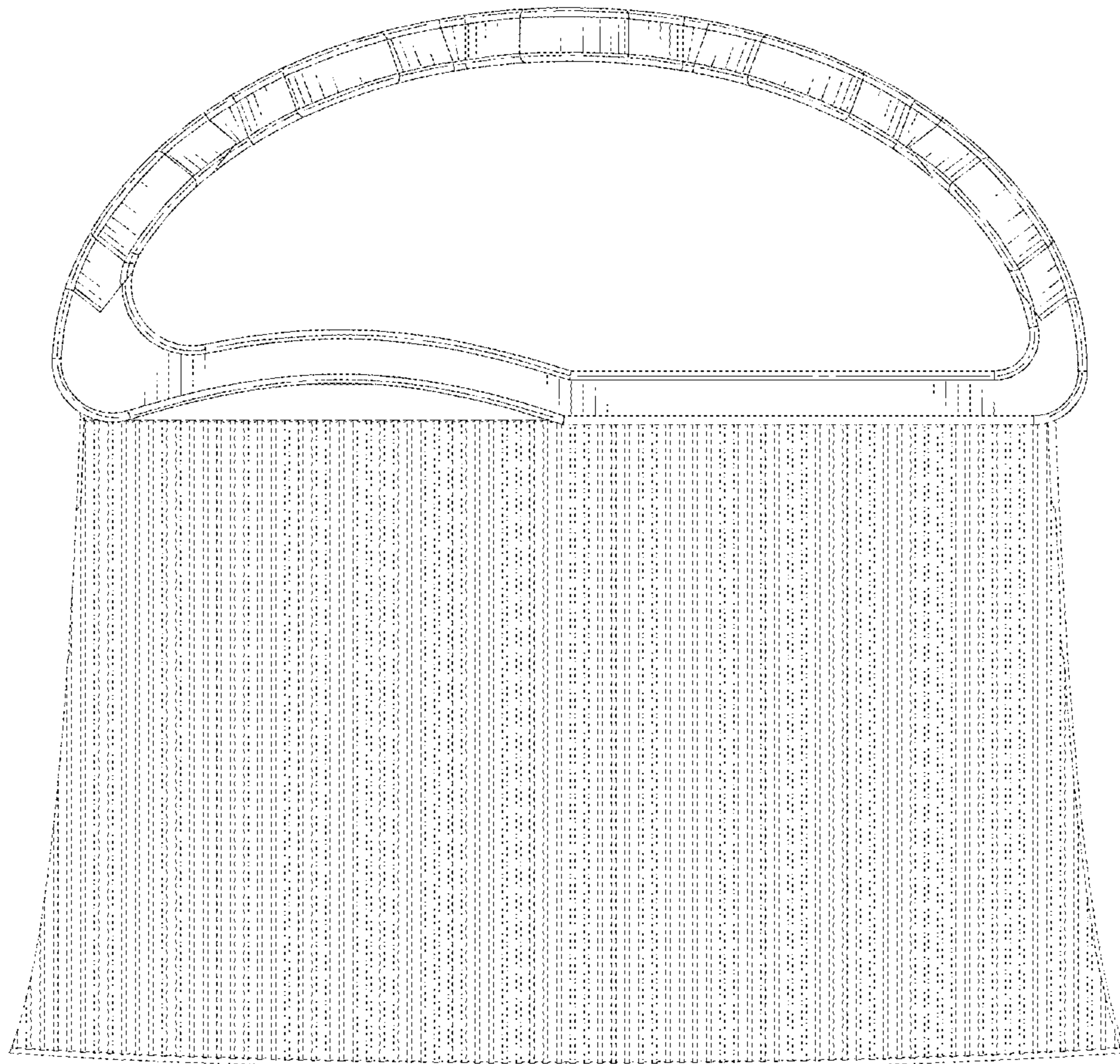

FIG. 3

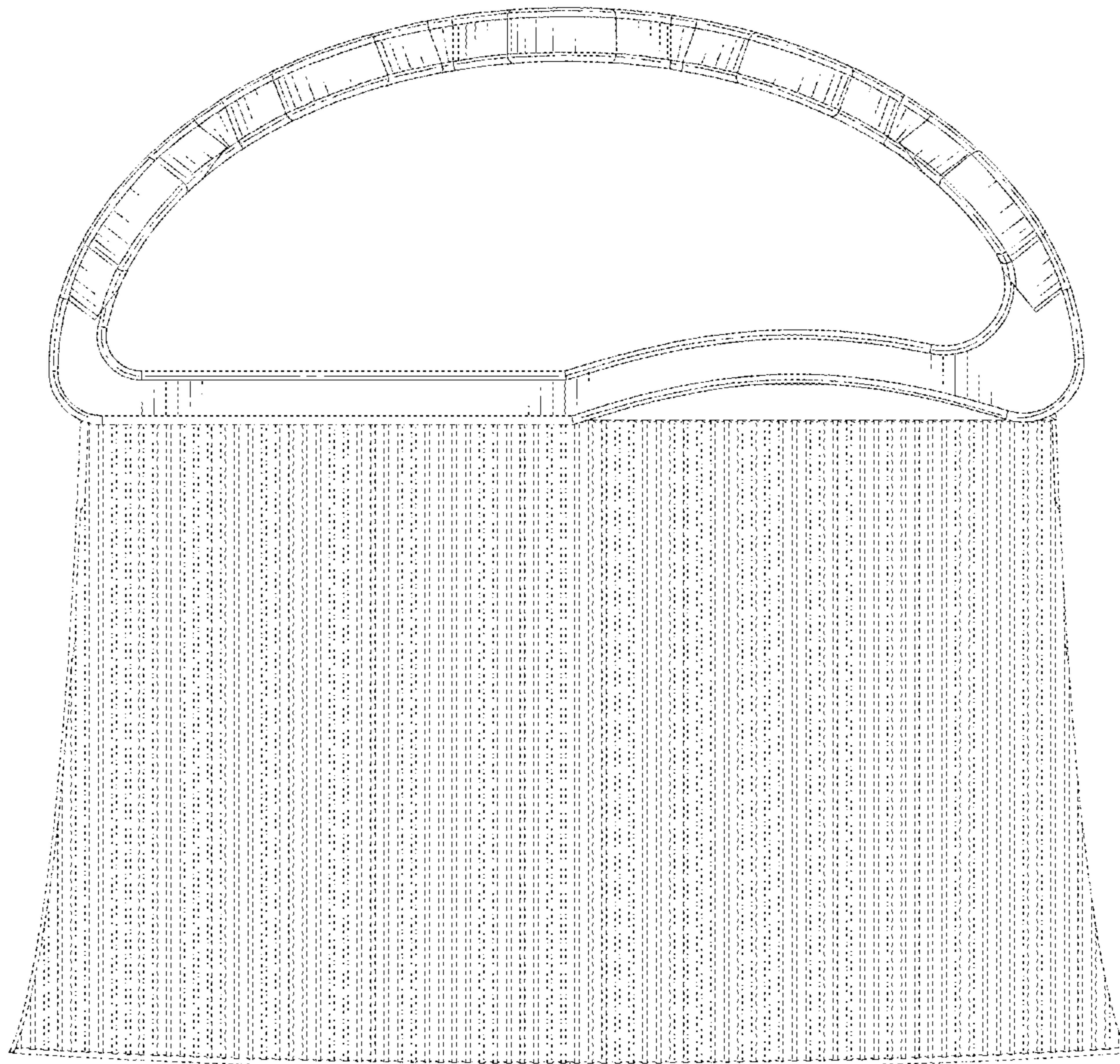

FIG. 4

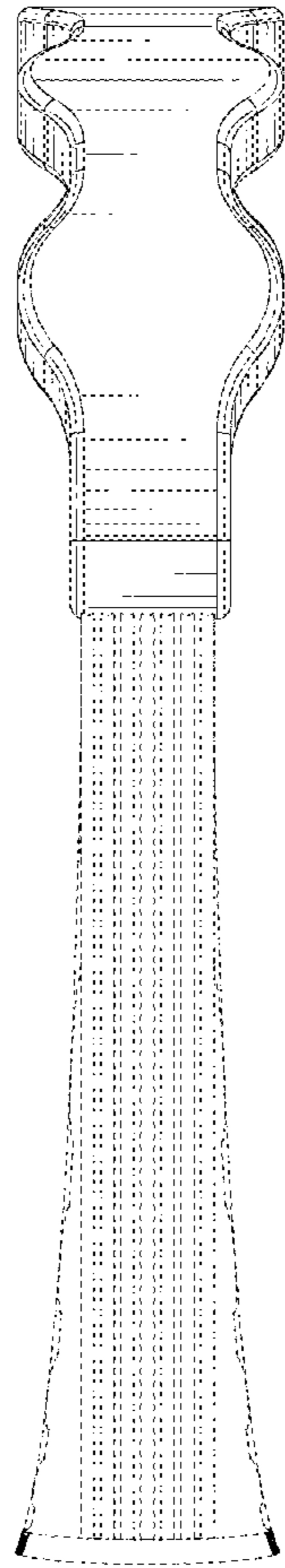

FIG. 5

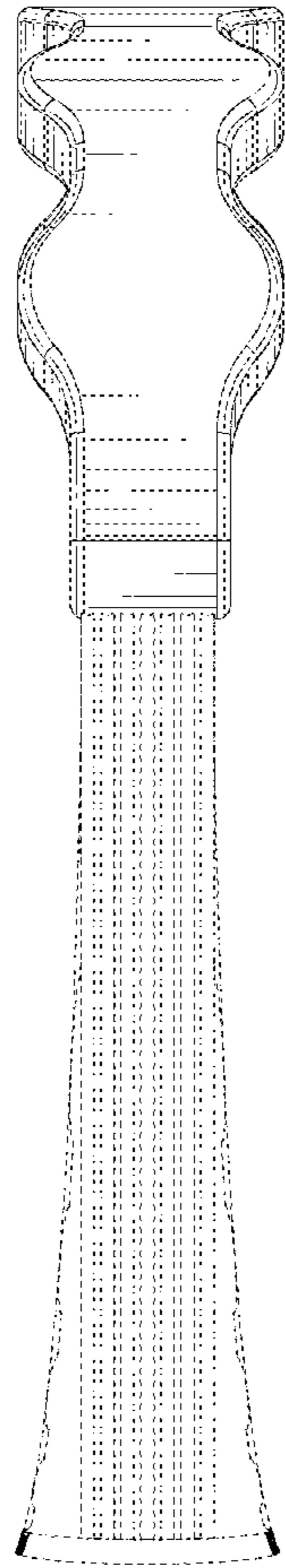

FIG. 6

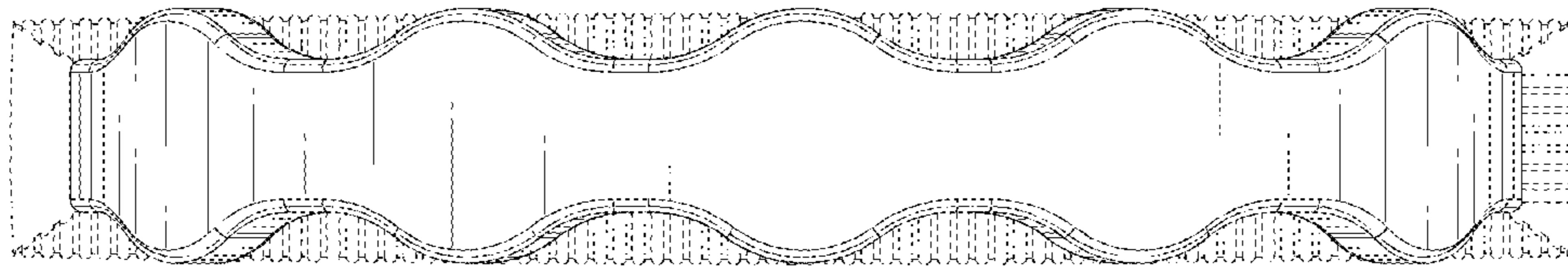

FIG. 7

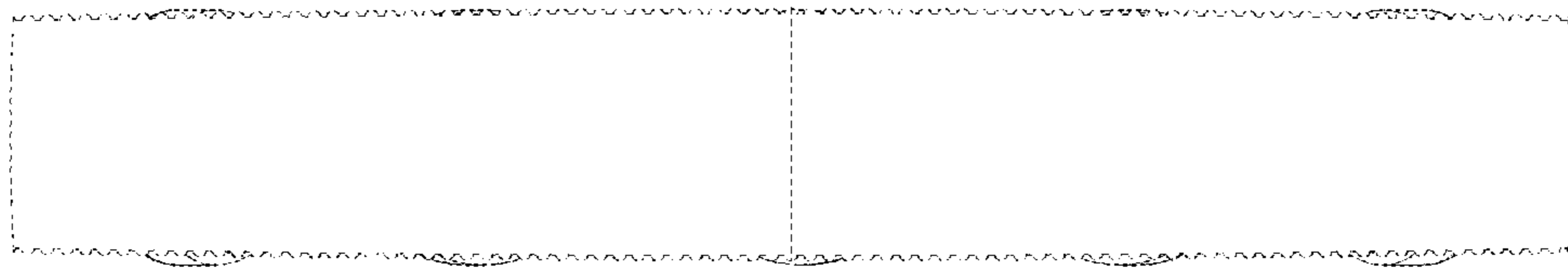

FIG. 8