



US00D961913S

(12) **United States Design Patent**
Rogers et al.

(10) **Patent No.:** **US D961,913 S**

(45) **Date of Patent:** **** Aug. 30, 2022**

(54) **BACKPACK**

(71) Applicant: **YETI Coolers, LLC**, Austin, TX (US)

(72) Inventors: **Kyle Edward Rogers**, Austin, TX (US); **John Loudenslager**, Austin, TX (US); **Calvin Tabor**, Austin, TX (US); **Victor Kang**, North Vancouver (CA); **Dustin Bullock**, Austin, TX (US)

(73) Assignee: **YETI Coolers, LLC**, Austin, TX (US)

(**) Term: **15 Years**

(21) Appl. No.: **29/726,166**

(22) Filed: **Feb. 28, 2020**

(51) **LOC (13) Cl.** **03-01**

(52) **U.S. Cl.**
USPC **D3/217**

(58) **Field of Classification Search**
USPC D3/216, 217
See application file for complete search history.

(56) **References Cited**

U.S. PATENT DOCUMENTS

699,944 A	5/1902	Carman et al.	
3,111,245 A	11/1963	Libit et al.	
3,718,238 A	2/1973	Hazard et al.	
3,863,818 A	2/1975	Hazard	
3,881,643 A	5/1975	LaVange	
4,674,661 A	6/1987	Herold	
4,776,501 A	10/1988	Ostrowsky	
5,065,909 A	11/1991	Pino et al.	
D323,237 S	1/1992	Zoltie	
D340,351 S	10/1993	Wrath	
D358,031 S	5/1995	Aumasson	
5,477,994 A	12/1995	Feer et al.	
D369,021 S	4/1996	Kliot	
5,542,585 A	8/1996	Peters et al.	
D375,622 S	* 11/1996	Croft	D3/217
D402,460 S	12/1998	Moor	

5,890,628 A	4/1999	Simpson et al.
5,984,154 A	11/1999	Scicluna
6,053,382 A	4/2000	Wyant
6,138,881 A	10/2000	Paul et al.
D437,110 S	2/2001	Ivarson et al.

(Continued)

FOREIGN PATENT DOCUMENTS

BE	005835121-0001	12/2018
BE	006320446-0001	4/2019

(Continued)

OTHER PUBLICATIONS

Rockland Milan Hybrid EVA/ABS 3-Piece Softside Luggage Set, Brown.

(Continued)

Primary Examiner — Jennifer L Watkins

(74) *Attorney, Agent, or Firm* — Banner & Witcoff, Ltd.

(57) **CLAIM**

The ornamental design for a backpack, as shown and described.

DESCRIPTION

FIG. 1 is a top, front, right perspective view of a backpack showing our new design; FIG. 2 is a front view thereof; FIG. 3 is a rear view thereof; FIG. 4 is a left side view thereof; FIG. 5 is a right side view thereof; FIG. 6 is a top view thereof; and, FIG. 7 is a bottom view thereof. The even-length broken lines and uneven-length broken lines in FIGS. 1-7 form no part of the claimed design. The zig-zag lines represent stitching.

1 Claim, 7 Drawing Sheets

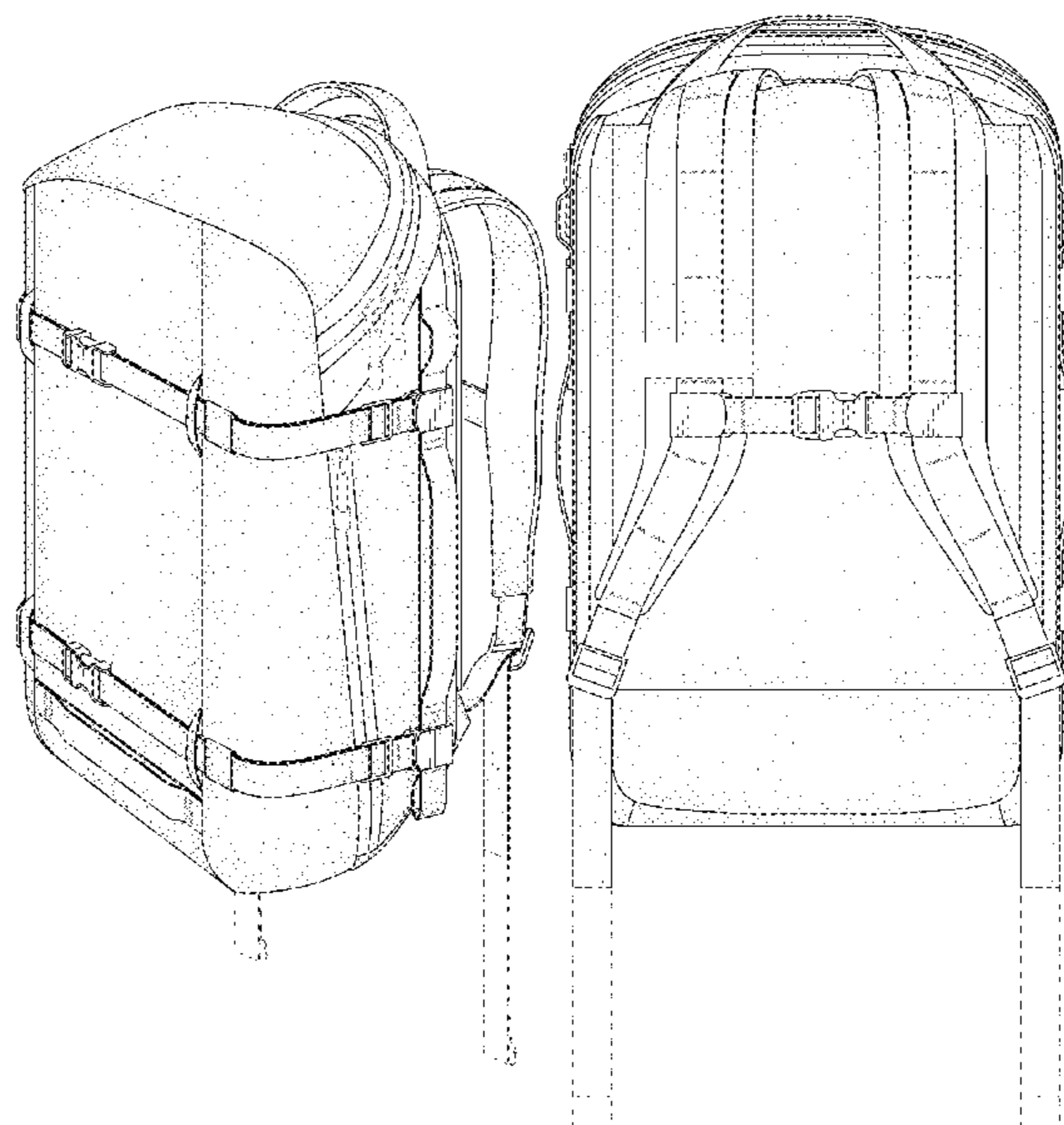

(56)

References Cited

U.S. PATENT DOCUMENTS

D441,190 S 5/2001 Eskandry
 D451,274 S 12/2001 Kegels
 6,345,414 B1 2/2002 Chen
 D457,307 S 5/2002 Pukall et al.
 D459,579 S 7/2002 Kegels
 D461,635 S 8/2002 Sharples
 D462,169 S 9/2002 Giovanni
 6,530,508 B1 3/2003 Devine
 D472,705 S 4/2003 Van Himbeec
 6,592,012 B2 7/2003 Godshaw et al.
 6,655,565 B2 12/2003 Godshaw et al.
 D484,686 S 1/2004 Nordstrom et al.
 D493,283 S 7/2004 Rada et al.
 D506,607 S 6/2005 Fonfeder
 D506,864 S 7/2005 Fonfeder
 D512,220 S 12/2005 Van Himbeec
 7,021,594 B2 4/2006 Exler
 7,152,772 B2 12/2006 Ukitsu et al.
 D547,054 S 7/2007 Kavovit
 D554,369 S 11/2007 Katz et al.
 D635,762 S 4/2011 Fahim
 D642,379 S 8/2011 Buller
 D658,363 S 5/2012 Biddle
 D666,414 S 9/2012 Giovannoni
 D673,363 S 1/2013 Crandall
 D675,016 S 1/2013 Van Overbeke
 8,397,978 B2 3/2013 Wang
 8,567,652 B2 10/2013 Di Stasio et al.
 D693,570 S 11/2013 Rathbun
 D699,942 S 2/2014 Mather
 D699,943 S 2/2014 Mather
 D699,944 S 2/2014 Mather
 D706,027 S 6/2014 Hock
 D706,533 S 6/2014 Hock
 D708,845 S 7/2014 Taylor
 8,789,734 B2 7/2014 Cross et al.
 D721,482 S 1/2015 Simmons
 D722,430 S 2/2015 Sagan et al.
 D722,431 S 2/2015 Sagan et al.
 D725,377 S 3/2015 Simmons
 D726,405 S 4/2015 Nassanian et al.
 D728,933 S 5/2015 Sanz et al.
 D731,181 S 6/2015 Majeau et al.
 9,125,477 B2 9/2015 Killion
 D742,631 S 11/2015 Kim
 D742,632 S 11/2015 Amago
 D745,777 S 12/2015 Zwetzig et al.
 D758,715 S 6/2016 Daniel et al.
 D759,369 S 6/2016 Mei Yee
 D770,761 S 11/2016 Deioma et al.
 D771,372 S 11/2016 Kelly et al.
 D771,373 S 11/2016 Kim
 D771,946 S 11/2016 Wu et al.
 D775,816 S 1/2017 Slimane
 D780,451 S 3/2017 Wu
 D781,049 S * 3/2017 Kemp D3/216
 D787,814 S 5/2017 Kim et al.
 9,642,443 B2 5/2017 Amago
 D793,733 S 8/2017 Mather
 D802,913 S 11/2017 Tien
 9,861,170 B1 1/2018 Hamaty
 9,877,558 B1 1/2018 Harstvedt
 D816,986 S 5/2018 Yang et al.
 D818,701 S 5/2018 Wright
 D824,660 S 8/2018 Ross
 D826,551 S 8/2018 Fusi
 D828,728 S 9/2018 Jacobsen
 D829,435 S 10/2018 Viger et al.
 D829,436 S 10/2018 Benzon et al.
 D834,818 S * 12/2018 Freitag D3/279
 D836,326 S 12/2018 Skaff
 D840,157 S 2/2019 Mather
 D840,682 S 2/2019 Thibadeau
 D841,318 S 2/2019 Carter et al.
 D841,977 S 3/2019 Testatonda

D841,978 S 3/2019 Ou
 D843,713 S 3/2019 Li et al.
 D843,714 S 3/2019 Sheikh
 D844,319 S 4/2019 Tan et al.
 D844,975 S 4/2019 Munie et al.
 D844,976 S 4/2019 Munie et al.
 D844,977 S 4/2019 Munie et al.
 D844,978 S 4/2019 Munie et al.
 D849,404 S 5/2019 Tricault
 10,314,384 B2 6/2019 de Geus
 D853,107 S 7/2019 Lyons
 D855,328 S 8/2019 Tobyansen et al.
 D856,675 S 8/2019 Shalgi
 D857,376 S 8/2019 Thibadeau
 D857,377 S 8/2019 Hong
 D858,986 S 9/2019 Shalgi
 D859,819 S 9/2019 Mather
 10,413,045 B2 9/2019 Crisp
 D871,163 S 12/2019 Jacobsen
 D872,472 S 1/2020 Wu
 D874,129 S 2/2020 Goldstein
 D891,091 S 7/2020 Baldemor
 D901,169 S 11/2020 Thibadeau
 D909,049 S * 2/2021 Watson D30/151
 D911,024 S 2/2021 Rabe et al.
 D922,062 S 6/2021 Shi
 D922,828 S * 6/2021 Munie D3/216
 D937,576 S * 12/2021 Thibadeau D3/217
 D942,141 S * 2/2022 Wang D3/217
 2004/0244115 A1 12/2004 Adams et al.
 2005/0258294 A1 11/2005 Dickson
 2009/0120946 A1 5/2009 Hung
 2010/0072235 A1 3/2010 Barton et al.
 2010/0086237 A1 4/2010 Diepen
 2012/0085804 A1 4/2012 Christy
 2012/0181129 A1 7/2012 Lai
 2014/0311844 A1 10/2014 Meersschaert et al.
 2016/0286913 A1 10/2016 Lai
 2021/0212442 A1 * 7/2021 Webb A45C 13/02

FOREIGN PATENT DOCUMENTS

BE 006376224-0001 4/2019
 CA 178631 S 6/2019
 CN 201238720 Y 5/2009
 CN 201381022 Y 1/2010
 CN 202385952 U 8/2012
 CN 202760412 U 3/2013
 CN 302437717 5/2013
 CN 202980539 U 6/2013
 CN 203105951 U 8/2013
 CN 203105975 U 8/2013
 CN 302530213 8/2013
 CN 302555021 9/2013
 CN 302684364 12/2013
 CN 203424484 U 2/2014
 CN 302877507 7/2014
 CN 204642520 U 9/2015
 CN 303743407 7/2016
 CN 303941346 11/2016
 CN 303982523 12/2016
 CN 304021954 2/2017
 CN 304022040 2/2017
 CN 206006380 U 3/2017
 CN 304099148 4/2017
 CN 206238705 U 6/2017
 CN 304213393 7/2017
 CN 304263206 9/2017
 CN 304281934 9/2017
 CN 304329889 10/2017
 CN 304403760 12/2017
 CN 304423208 12/2017
 CN 304434555 1/2018
 CN 304440472 1/2018
 CN 304447076 1/2018
 CN 304452400 1/2018
 CN 304440526 2/2018
 CN 304485556 2/2018
 CN 304485557 2/2018

(56)

References Cited

FOREIGN PATENT DOCUMENTS		
CN	304507404	2/2018
CN	304527086	3/2018
CN	304539058	3/2018
CN	304562668	4/2018
CN	304574678	4/2018
CN	304580854	4/2018
CN	304597895	4/2018
CN	304585913	5/2018
CN	304601577	5/2018
CN	304668136	6/2018
CN	304697070	6/2018
CN	304701671	6/2018
CN	304707965	7/2018
CN	304749482	7/2018
CN	304754828	8/2018
CN	304754830	8/2018
CN	304760026	8/2018
CN	304760027	8/2018
CN	304764997	8/2018
CN	304790969	8/2018
CN	304954803	8/2018
CN	207821348 U	9/2018
CN	304854926	10/2018
CN	304890081	11/2018
CN	304922883	12/2018
CN	304930117	12/2018
CN	304936544	12/2018
CN	304936586	12/2018
CN	304943105	12/2018
CN	304954760	12/2018
CN	304954761	12/2018
CN	305168528	12/2018
CN	304977719	1/2019
CN	304983165	1/2019
CN	304988993	1/2019
CN	305000921	1/2019
CN	305012940	1/2019
CN	305012942	1/2019
CN	305073540	3/2019
CN	305122132	4/2019
CN	305127641	4/2019
CN	305127739	4/2019
CN	305184126	5/2019
CN	305184246	5/2019
CN	305184247	5/2019
CN	109832772 A	6/2019
CN	305224817	6/2019
CN	305224829	7/2019
CN	305242404	7/2019
CN	305247322	7/2019
CN	305257926	7/2019
CN	305262894	7/2019
CN	305262936	7/2019
CN	305272235	7/2019
CN	305272278	7/2019
CN	305277919	7/2019
CN	305283139	8/2019
CN	305283157	8/2019
CN	305283218	8/2019
CN	305309521 S	8/2019
CN	305329378	9/2019
CN	305329379	9/2019
CN	305369149	10/2019
CN	305378377	10/2019
CN	209628849 U	11/2019
DE	001566639-0008	9/2009
DE	004030153-0024	6/2017
DE	004494086-0014	11/2017
EM	000544663-0001	7/2006
EM	000961909-0021	11/2008
EM	001566639-0008	9/2009
EM	001263875-0003	3/2011
EM	001284673-0012	8/2011
EM	001915059-0001	9/2011
EM	001915059-0002	9/2011

EM	002438788-0002	4/2014
EM	002624833-0001	2/2015
EM	002624833-0002	2/2015
EM	002624833-0003	2/2015
EM	002624833-0004	2/2015
EM	003996669-0001	6/2017
EM	004030153-0024	6/2017
EM	004398295-0010	10/2017
EM	004494086-0014	11/2017
EM	005814290-0002	11/2018
EM	006320446-0001	4/2019
EM	006376224-0001	4/2019
EM	006379541-0001	4/2019
EM	006371563-0001	6/2019
EM	006371563-0002	6/2019
EM	006594040-0001	6/2019
EM	006595211-0001	7/2019
EM	006617627-0001	7/2019
FR	006379541-0001	4/2019
GB	2293818 A	4/1996
GB	005609872-0001	11/2018
IT	000544663-0001	7/2006
IT	006371563-0001	6/2019
IT	006371563-0002	6/2019
IT	006594040-0001	6/2019
JP	D1635389	6/2019
KR	200270798	4/2002
KR	301016947	7/2019
KR	301016947.0000	7/2019
NL	006595211-0001	7/2019
SE	002438788-0002	4/2014
SE	002624833-0002	2/2015
SE	006617627-0001	7/2019
WO	03042049 A1	5/2003
WO	07121426 A2	10/2007
WO	09123661 A1	10/2009
WO	D097998-001	10/2017
WO	D201520-003	3/2019

OTHER PUBLICATIONS

The Best Carry-On Luggage Updated Oct. 24, 2019.
The North Face Stratoliner 75 Review.
“Thule Crossover Backpack”; thule; retrieved Aug. 21, 2019; disclosure date unknown but prior to the filing date of the present application; URL: <https://www.thule.com/en-us/us/backpacks/laptop-backpacks/thule-crossover-backpack-25I-_-tl_85854231350>.
“CityLite Pro Security Backpack”; targus; retrieved Aug. 21, 2019; disclosure date unknown but prior to the filing date of the present application; URL: <<https://us.targus.com/products/citylite-pro-15-6-security-backpack-tsb938gl>>.
“Creek Mandate”; black diamond equipment; retrieved Aug. 21, 2019; disclosure date unknown but prior to the filing date of the present application; URL: <https://www.blackdiamondequipment.com/en_US/creek-mandate-28-BD681198_cfg.html>.
“Entity 23 CCW-Enabled Laptop Backpack”; maxpedition; retrieved Aug. 22, 2019; disclosure date unknown but prior to the filing date of the present application; URL: <<https://www.maxpedition.com/collections/backpacks/products/entity-23-ccw-enabled-laptop-backpack?variant=15960726274119>>.
“Midtown Convertible Backpack”; vera bradley; retrieved Aug. 22, 2019; disclosure date unknown but prior to the filing date of the present application; URL: <<https://www.verabradley.com/us/product/Midtown-Convertible-Backpack/23879-23879481?Ntt=VB-PDP-BAGS-BACKPACKS-PDP-VB>>.
“Lighten Up Journey Backpack”; vera bradley; retrieved Aug. 22, 2019; disclosure date unknown but prior to the filing date of the present application; URL: <<https://www.verabradley.com/us/product/Lighten-Up-Journey-Backpack/23628-23628M16?Ntt=VB-PDP-BAGS-BACKPACKS-PDP-VB>>.
“HP Active Backpack”; hp; retrieved Aug. 22, 2019; disclosure date unknown but prior to the filing date of the present application; URL: <<https://store.hp.com/us/en/pdp/hp-active-backpack>>.

(56)

References Cited

OTHER PUBLICATIONS

“Small Expandable Knack Pack”; Knack Pack; retrieved Nov. 26, 2019; disclosure date unknown but prior to the filing date of the present application; <https://knackbags.com/products/small-expandable-knackpack?variant>.

“Veballensty Sling Backpack”; Veballensty; retrieved Nov. 26, 2019; disclosure date unknown but prior to the filing date of the present application; <https://www.amazon.com/Veballensty-Sling-Backpack>.

“Venture Pal 40L Lightweight Packable Waterproof Travel Hiking Backpack Daypack”; Venture; retrieved Nov. 26, 2019; disclosure date unknown but prior to the filing date of the present application; <https://www.amazon.com/Venture-Pal-40L-Lightweight-Packable-Waterproof-Travel-Hiking-Backpack>.

“MIER 30L Roll-Top Waterproof Backpack Heavy Duty Kayaking Floating Dry Bag, Grey”; MIER; retrieved Nov. 26, 2019; disclosure date unknown but prior to the filing date of the present application; <https://www.amazon.com/MIER-30L-Roll-top-Waterproof-Backpack-Heavy-Duty-Kayaking-Floating>.

“Helikon-Tex Groundhog Pack, Urban Line”; Helikon-Tex; retrieved Nov. 26, 2019; disclosure date unknown but prior to the filing date of the present application; <https://www.amazon.com/Helikon-Tex-Groundhog-Pack-Urban-Line>.

“Condor 3 Day Assault Pack”; retrieved Nov. 26, 2019; disclosure date unknown but prior to the filing date of the present application; <https://www.amazon.com/Condor-3-Day-Assault-Pack-Tactical-Backpack>.

“Best Anti Theft Backpacks of 2019”; Outdoor Crunch; retrieved Nov. 26, 2019; disclosure date unknown but prior to the filing date of the present application; <https://outdoorcrunch.com/best-anti-theft-backpack>.

Can the Yeti Crossroads 23 Backpack Work for a Photographer?, posted at thephoblogapher.com, posted Jan. 15, 2020, retrieved May 27, 2021, online, URL: <https://www.thephoblogapher.com/2020/01/15/can-the-yeti-crossroads-23-backpack-work-for-a-photographer/> (Year: 2020).

YETI Crossroads Backpack 23 and YETI Crossroads Tote 16 Bag Review, posted at gearmashers.com, posted Oct. 27, 2019, retrieved May 27, 2021, online, URL: <https://gearmashers.com/yeti-crossroads-backpack-23-and-yeti-crossroads-tote-16-bag-review/> (Year: 2019).

YETI Crossroads Backpack 23 Review (Initial Thoughts), posted at youtube.com, posted Sep. 11, 2019, retrieved May 27, 2021, online, URL: <https://www.youtube.com/watch?v=ngbJey-uJgE> (Year: 2019).

* cited by examiner

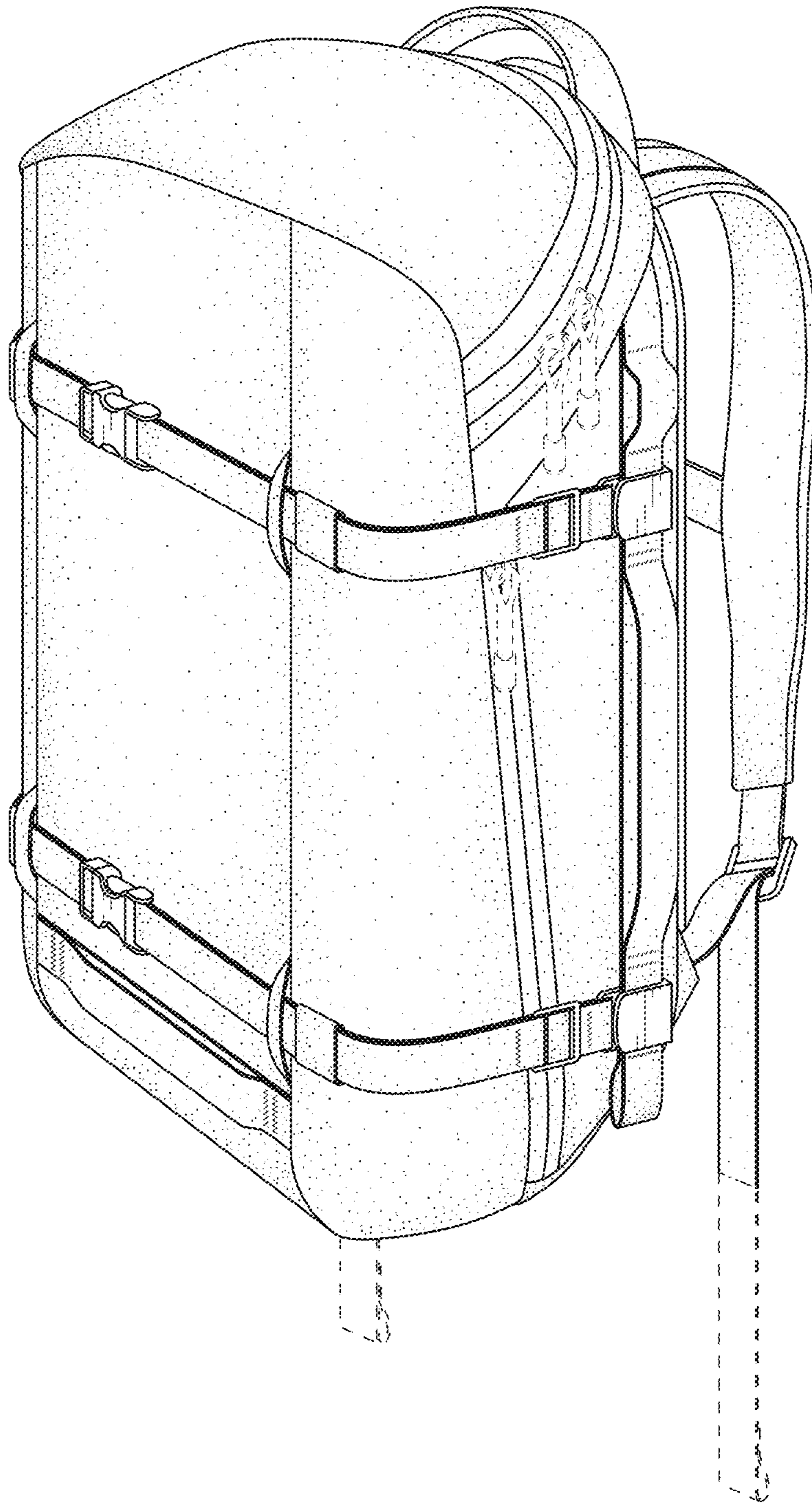

FIG. 1

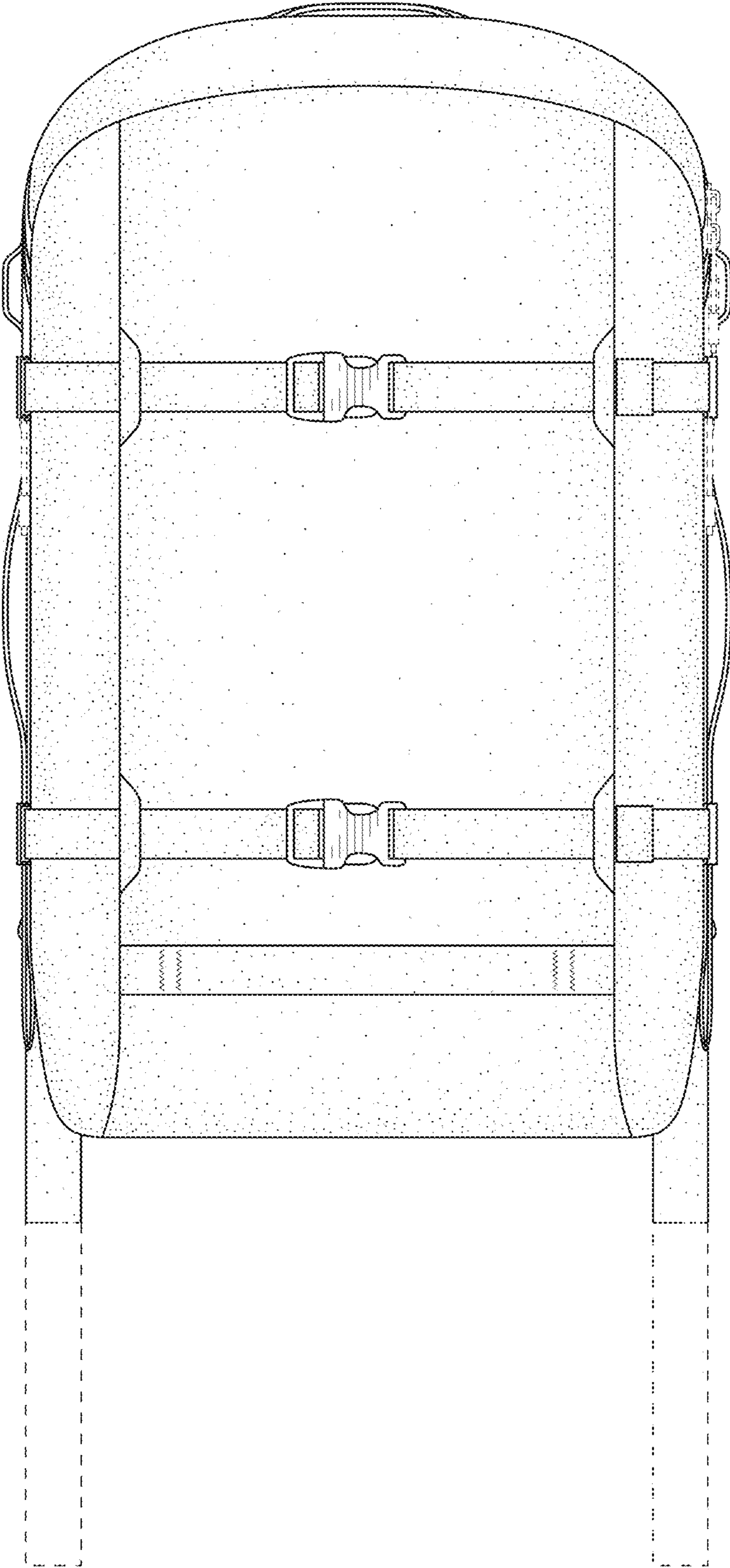

FIG. 2

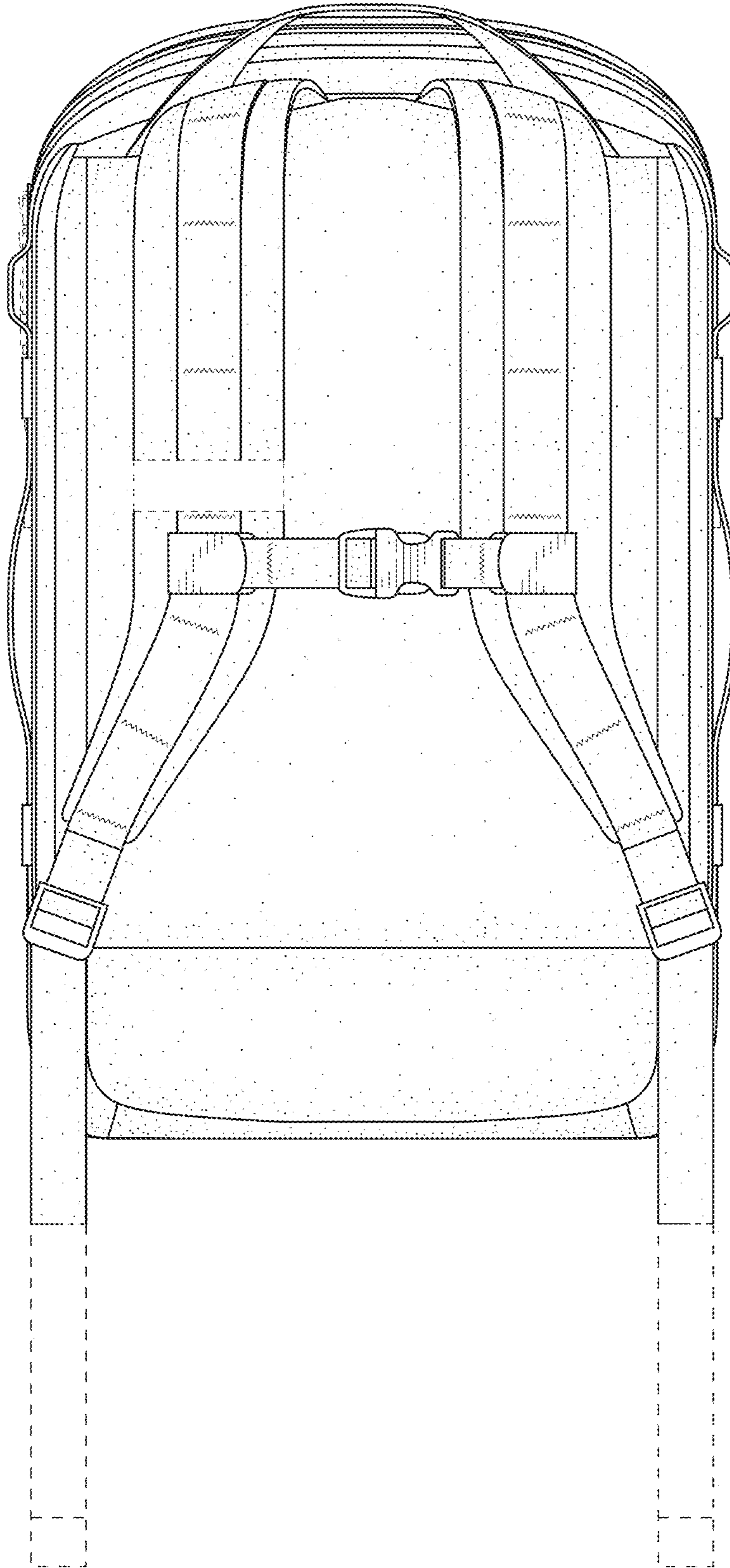

FIG. 3

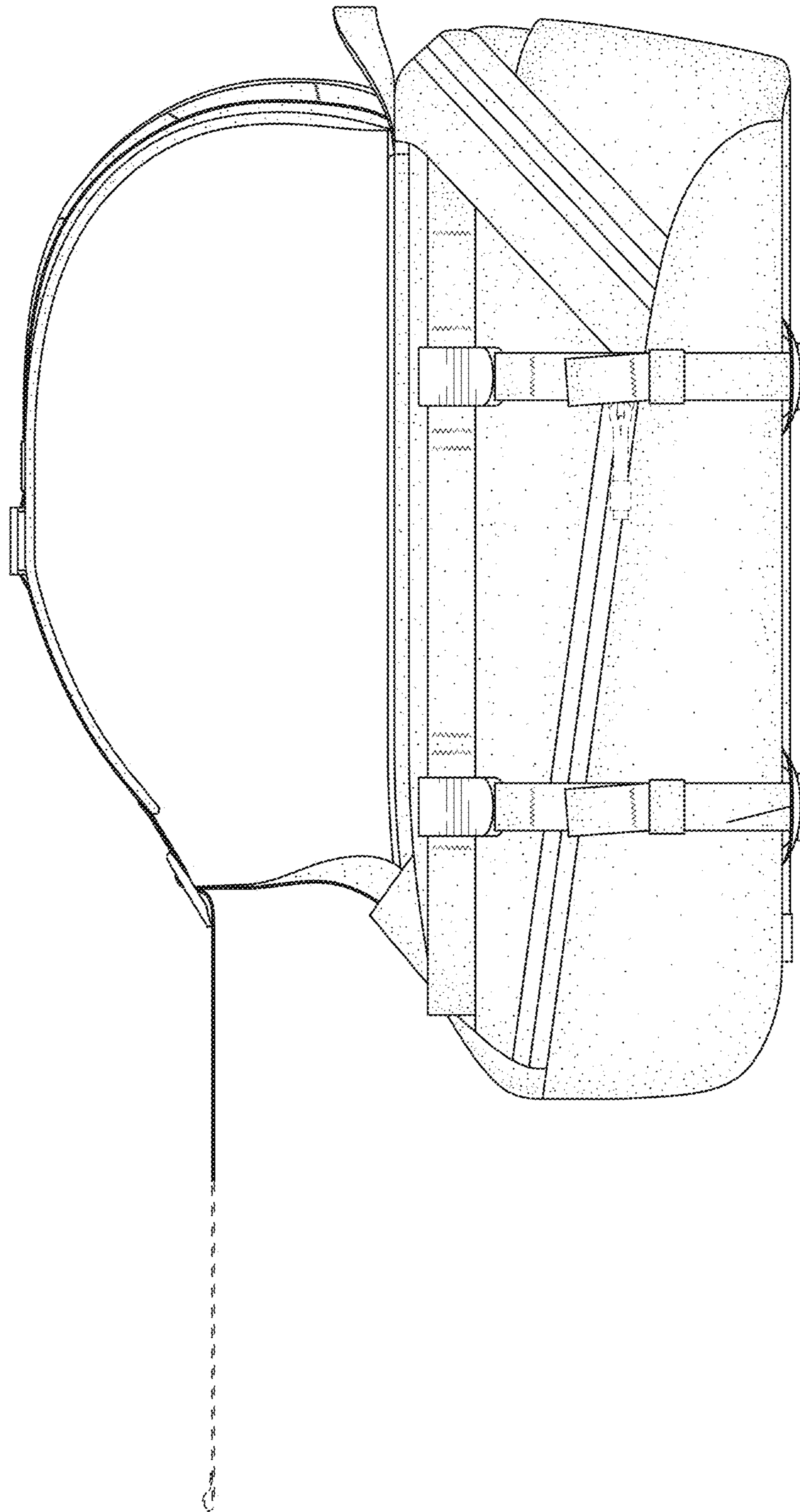

FIG. 4

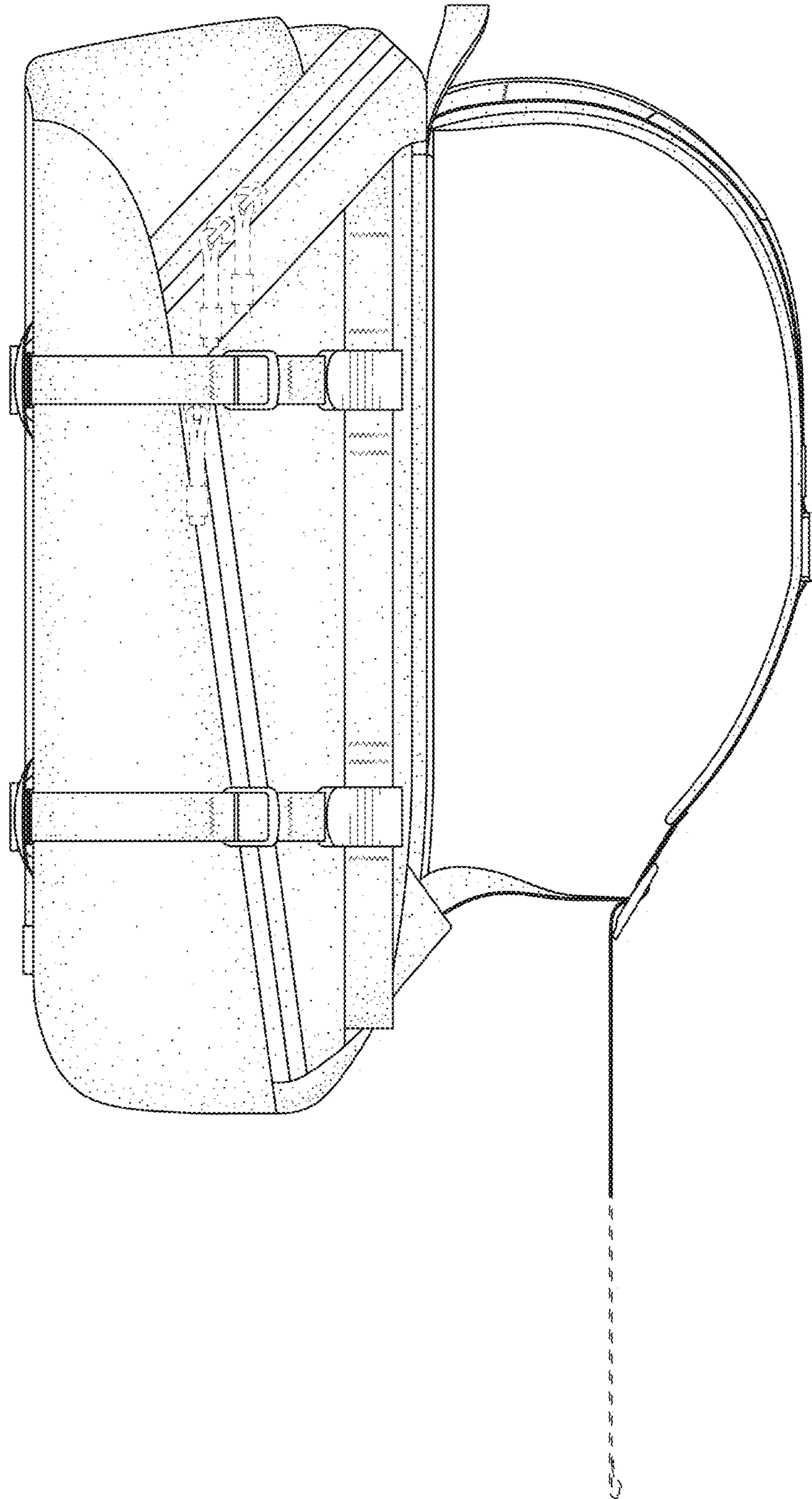

FIG. 5

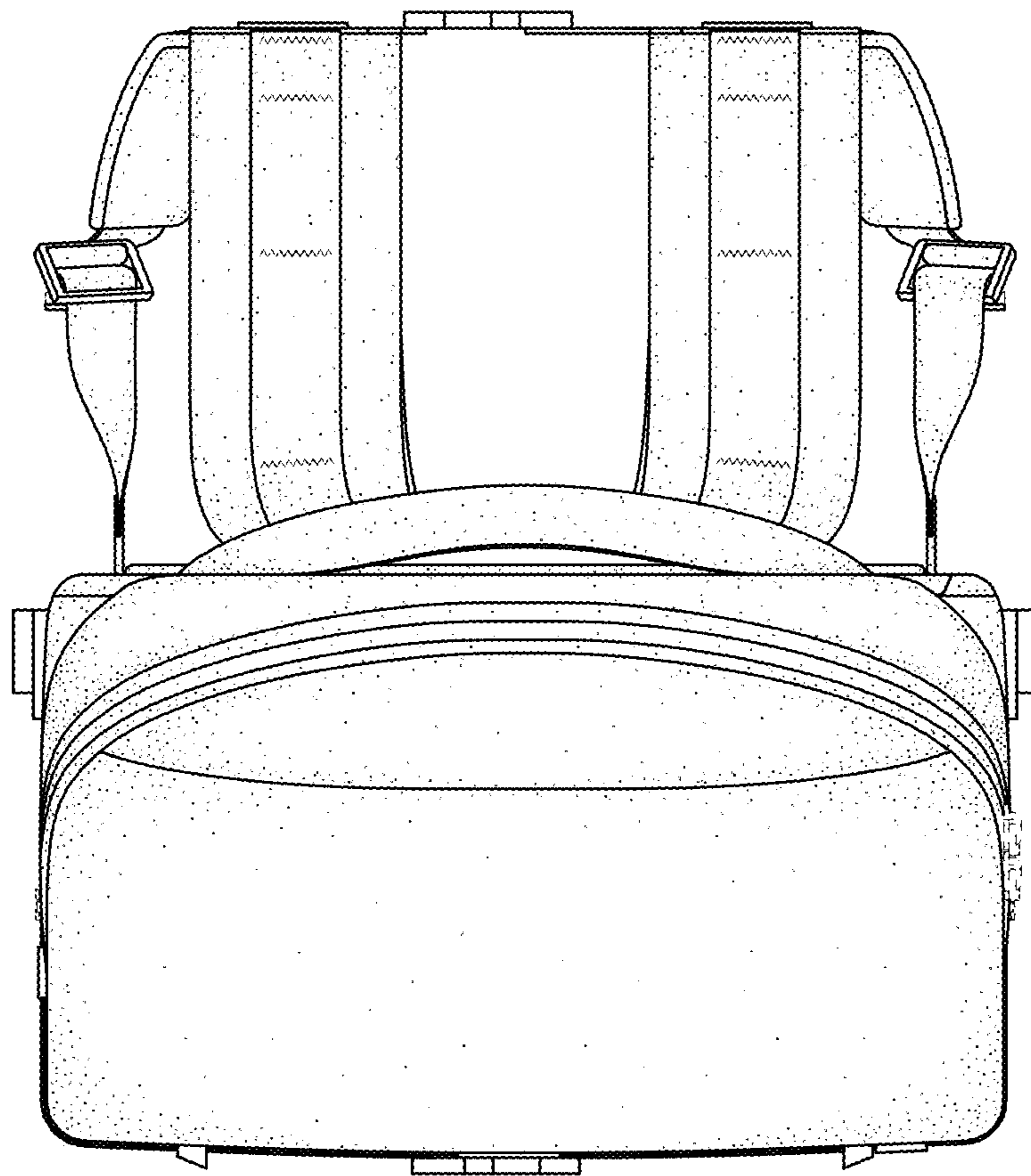

FIG. 6

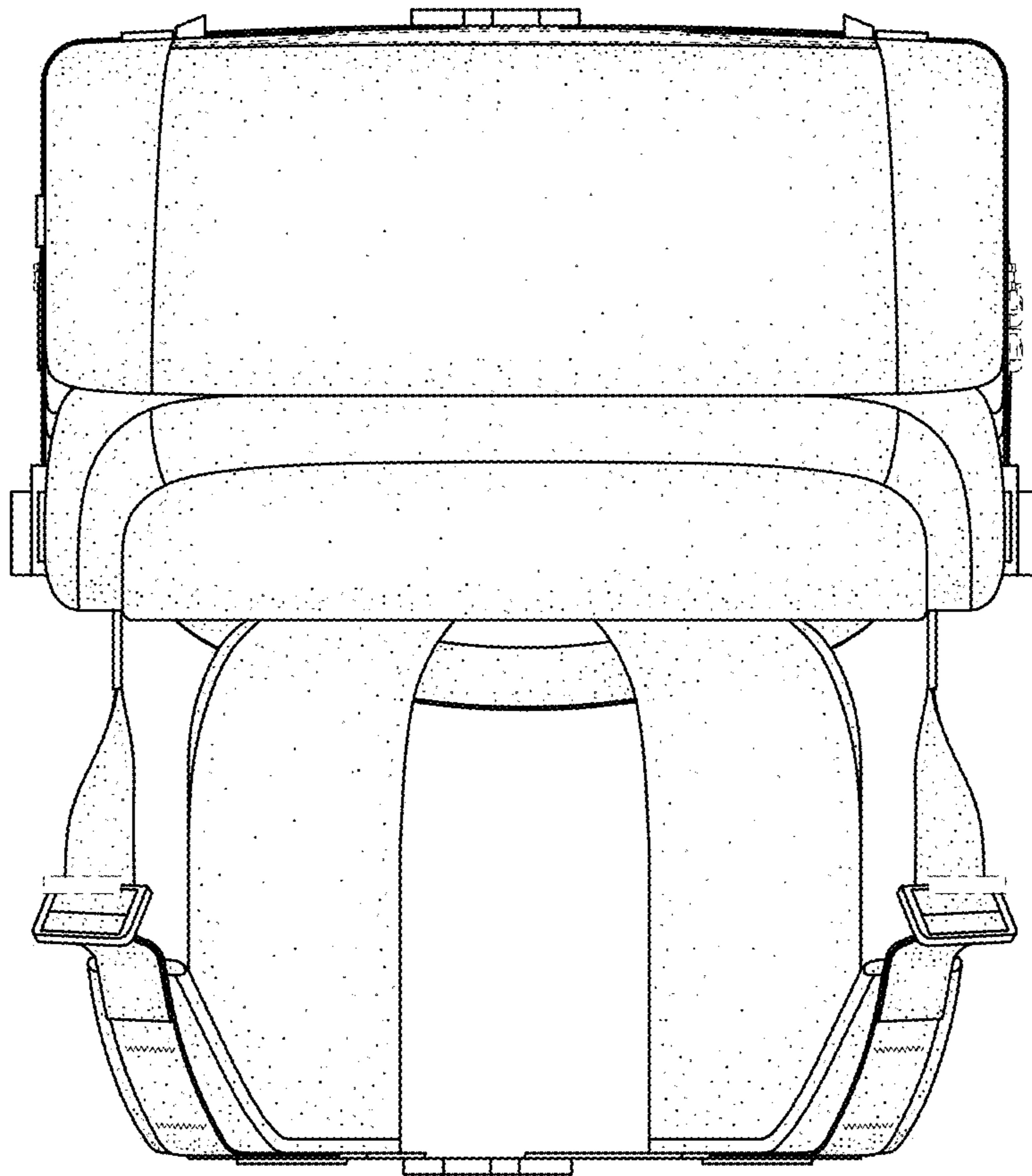

FIG. 7