



US00D961883S

(12) **United States Design Patent**  
**Zhang et al.**

(10) **Patent No.:** **US D961,883 S**

(45) **Date of Patent:** **\*\* Aug. 23, 2022**

(54) **HOUSEHOLD GARBAGE CAN**

(71) Applicant: **JINHUA KOYON ENVIRONMENTAL TECHNOLOGY CO., LTD.**, Zhejiang (CN)

(72) Inventors: **Kangdong Zhang**, Zhejiang (CN); **Xinxin Du**, Zhejiang (CN); **Zhuolei Li**, Zhejiang (CN)

(73) Assignee: **JINHUA KOYON ENVIRONMENTAL TECHNOLOGY CO., LTD.**, Jinhua (CN)

(\*\*) Term: **15 Years**

(21) Appl. No.: **29/733,049**

(22) Filed: **Apr. 29, 2020**

(30) **Foreign Application Priority Data**

Oct. 29, 2019 (CN) ..... 201930591920.9

(51) **LOC (13) Cl.** ..... **09-09**

(52) **U.S. Cl.**  
USPC ..... **D34/7**

(58) **Field of Classification Search**  
USPC ..... D34/1-11  
CPC .. B65F 1/163; B65F 1/00; B65F 1/122; B65F 2001/1489; Y10S 220/908  
See application file for complete search history.

(56) **References Cited**

**U.S. PATENT DOCUMENTS**

5,072,852 A \* 12/1991 Smith ..... B30B 9/321  
220/495.09  
D615,722 S \* 5/2010 Yang ..... D34/7

D620,667 S \* 7/2010 Liao ..... D34/9  
D641,121 S \* 7/2011 Rampton ..... D34/5  
D842,572 S \* 3/2019 Liao ..... D34/9  
D925,153 S \* 7/2021 Busch ..... D34/1  
D936,929 S \* 11/2021 Joseph ..... D34/11

\* cited by examiner

*Primary Examiner* — Cynthia Ramirez

*Assistant Examiner* — Tamara L Hahn

(74) *Attorney, Agent, or Firm* — Oliff PLC

(57) **CLAIM**

The ornamental design for a household garbage can, as shown and described.

**DESCRIPTION**

FIG. 1 is a perspective view of a first embodiment of the household garbage can;  
FIG. 2 is a front elevational view thereof;  
FIG. 3 is a rear elevational view thereof;  
FIG. 4 is a left-side elevational view thereof;  
FIG. 5 is a right-side elevational view thereof;  
FIG. 6 is a top plan view thereof;  
FIG. 7 is a bottom plan view thereof;  
FIG. 8 is a perspective view of a second embodiment of the household garbage can;  
FIG. 9 is a front elevational view thereof;  
FIG. 10 is a rear elevational view thereof;  
FIG. 11 is a left-side elevational view thereof;  
FIG. 12 is a right-side elevational view thereof;  
FIG. 13 is a top plan view thereof; and,  
FIG. 14 is a bottom plan view thereof.

**1 Claim, 14 Drawing Sheets**

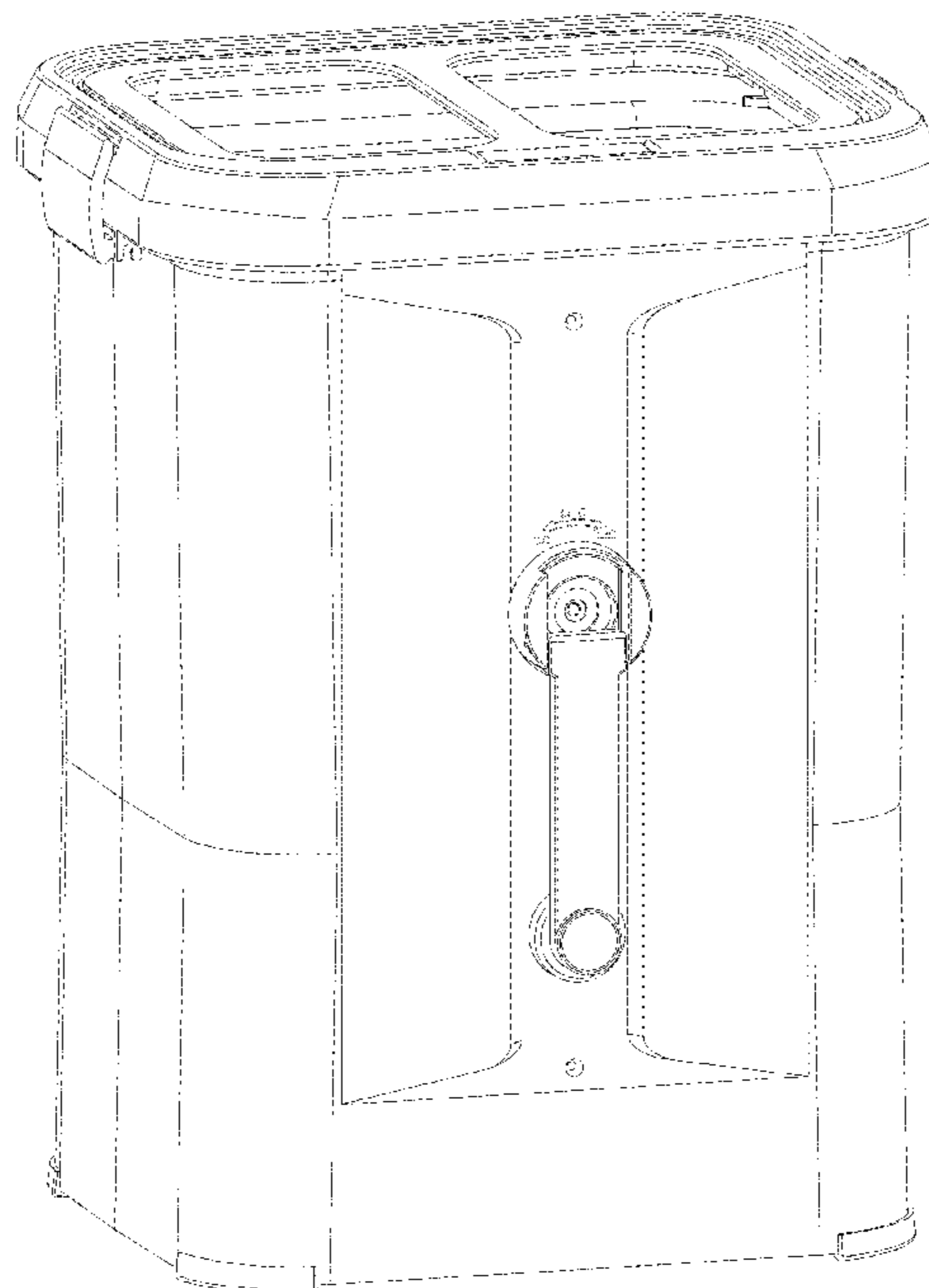

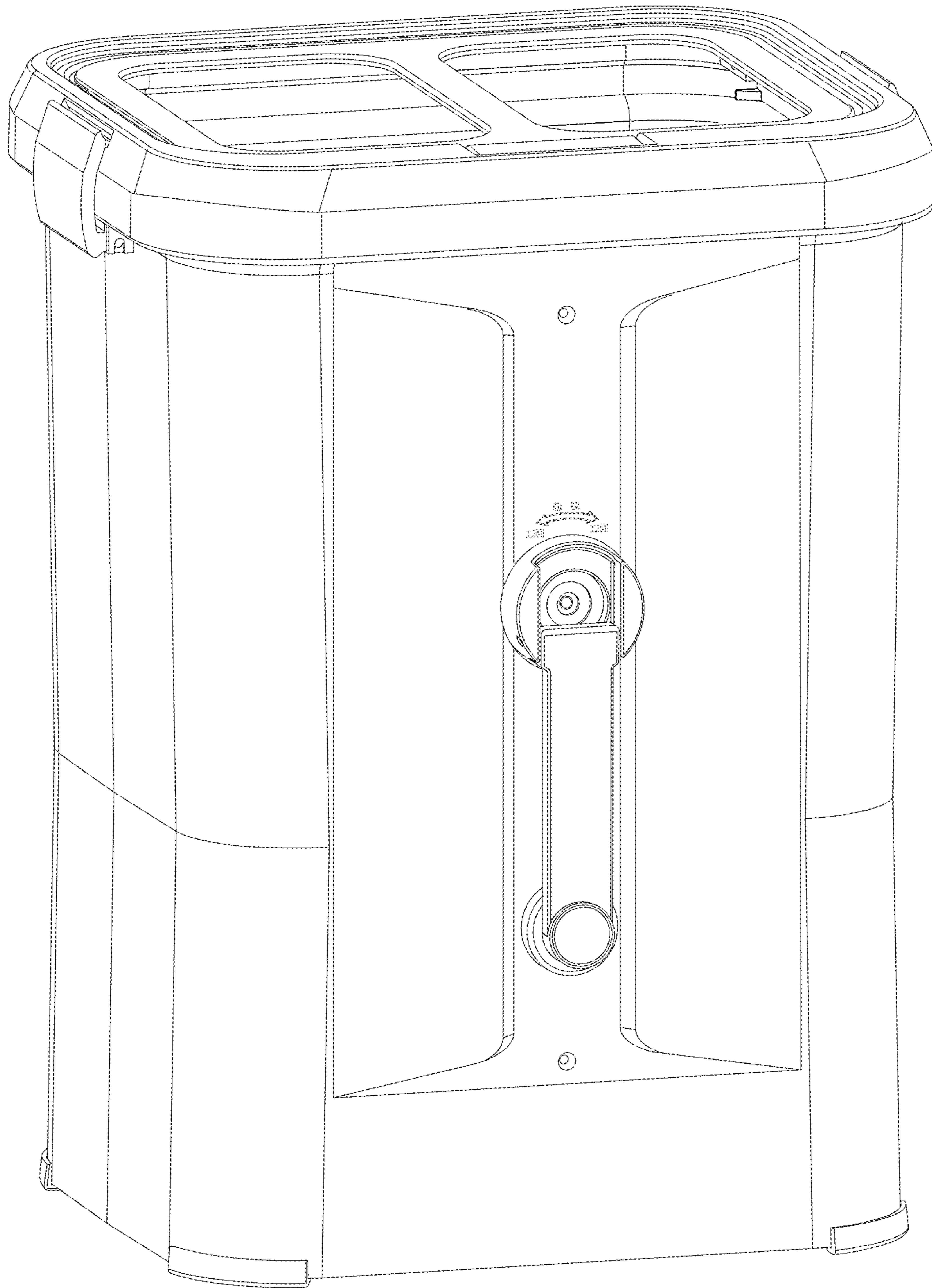

FIG. 1

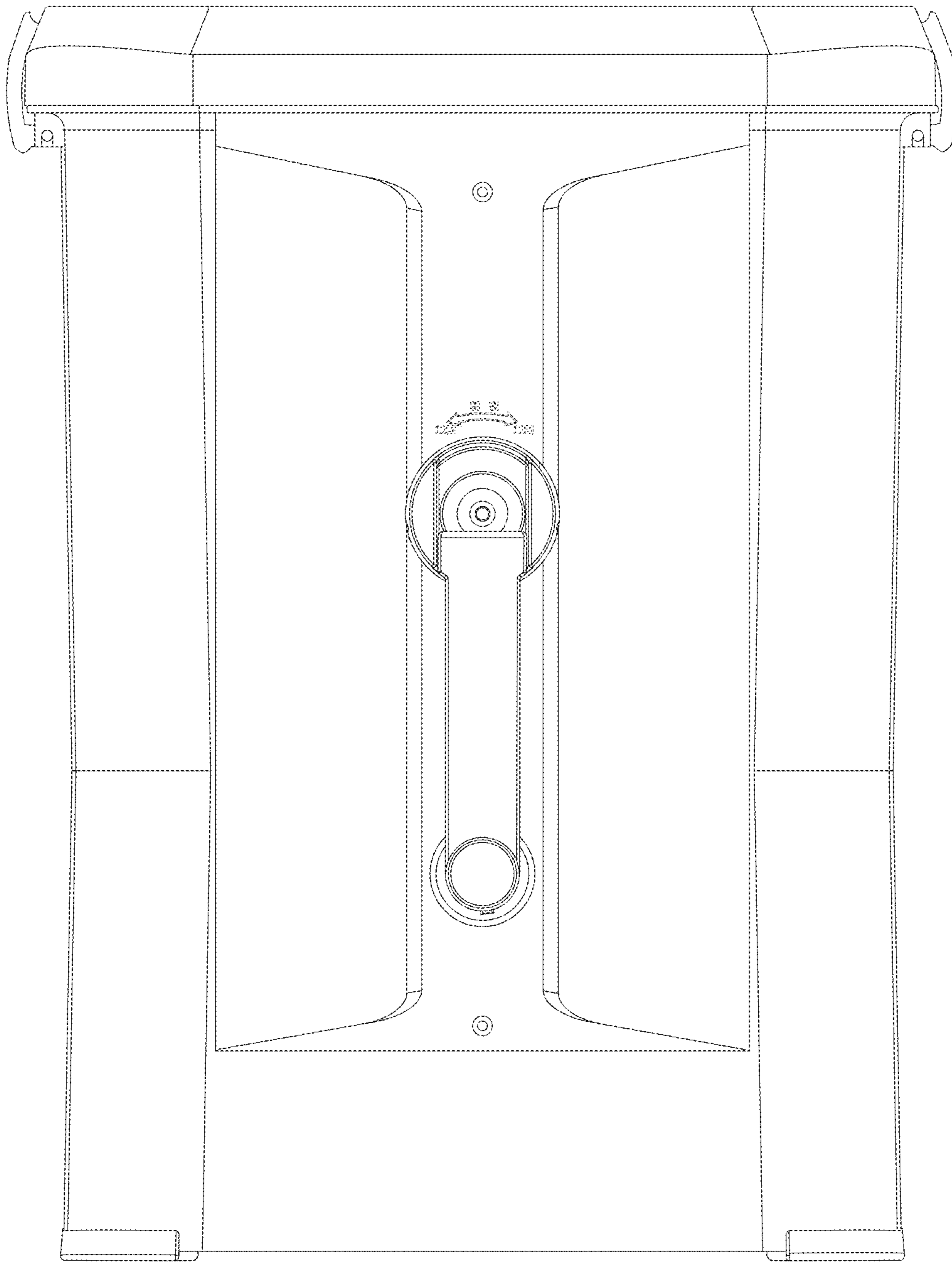

FIG. 2

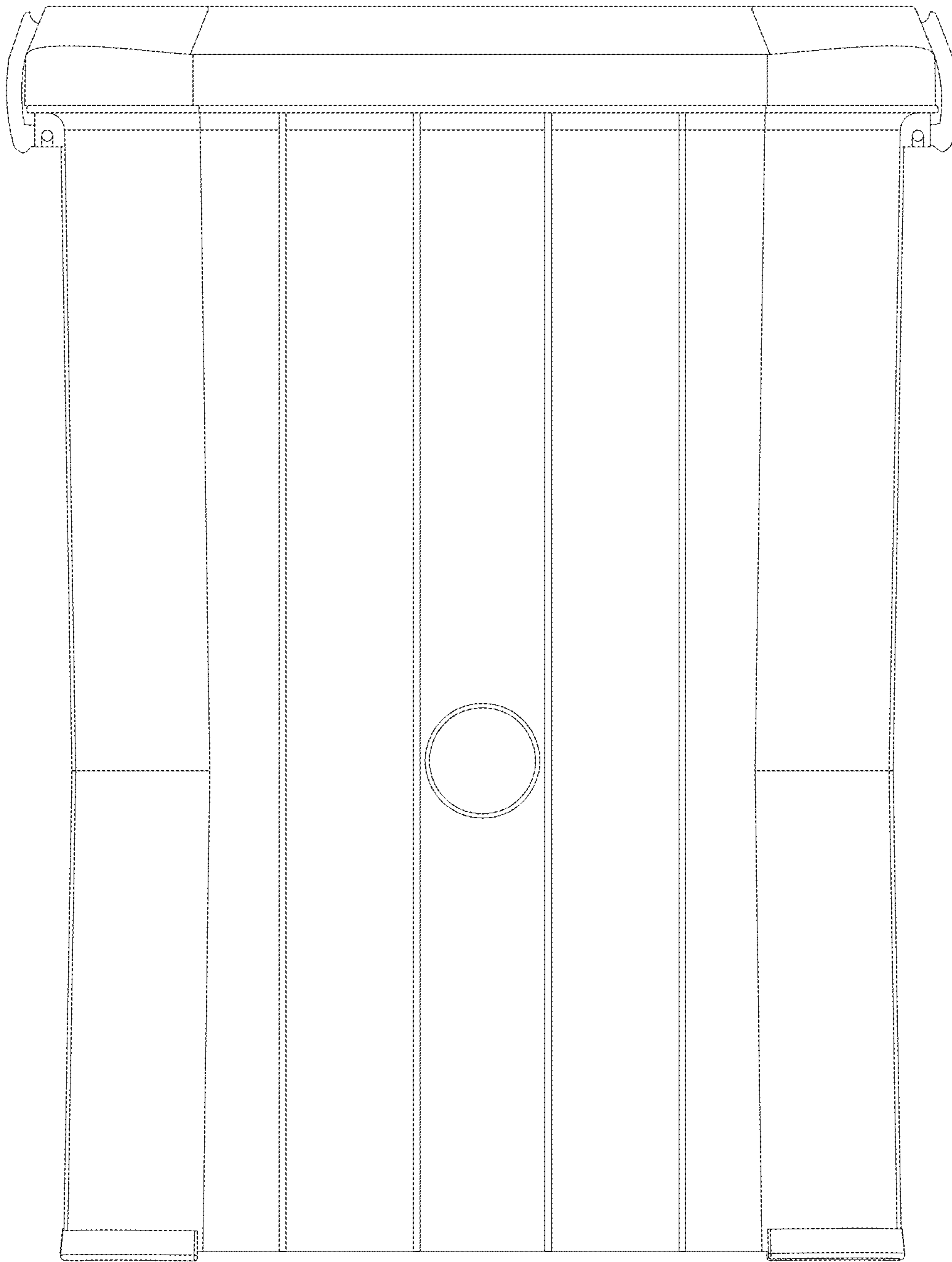

FIG. 3

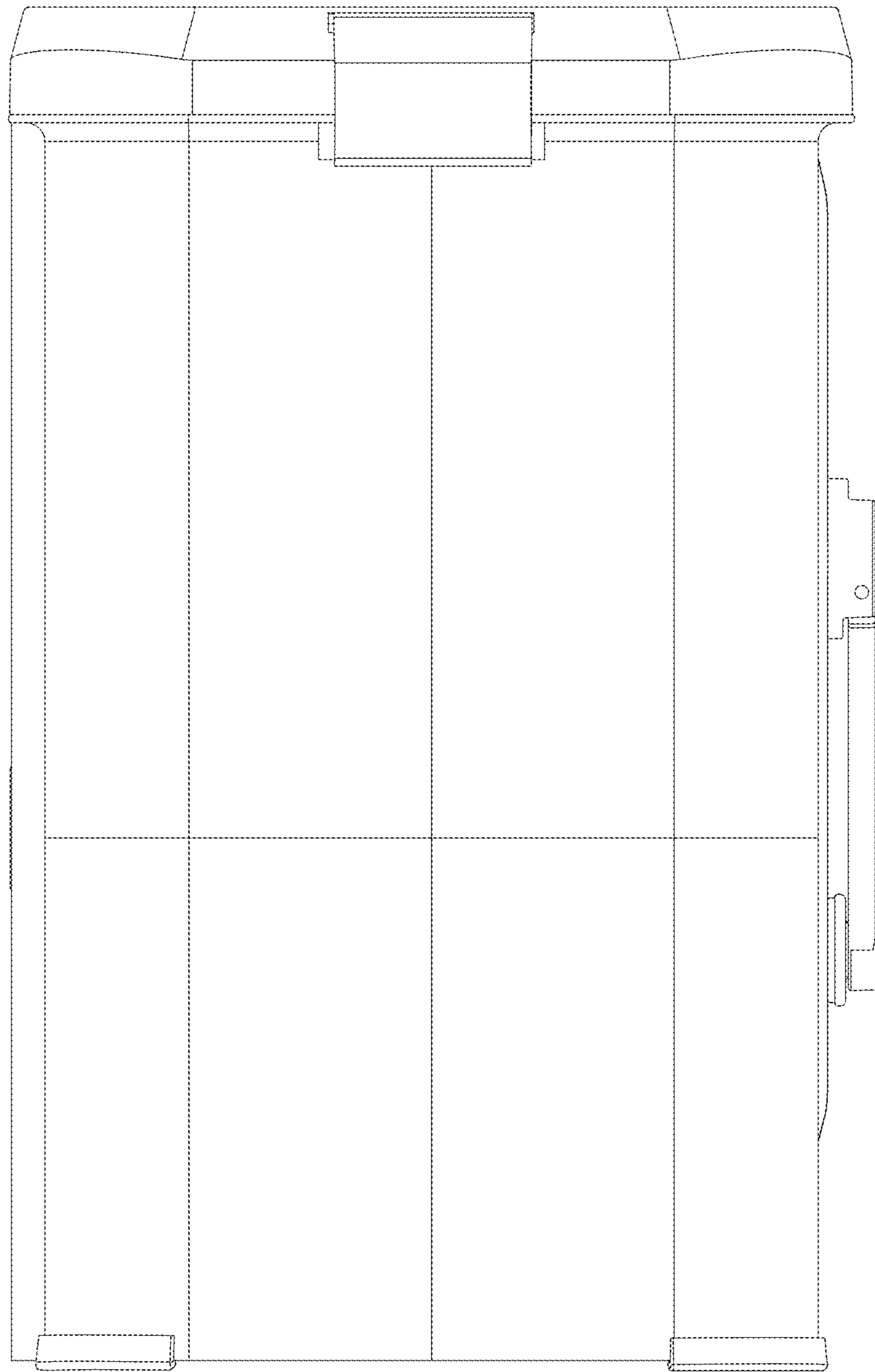

FIG. 4

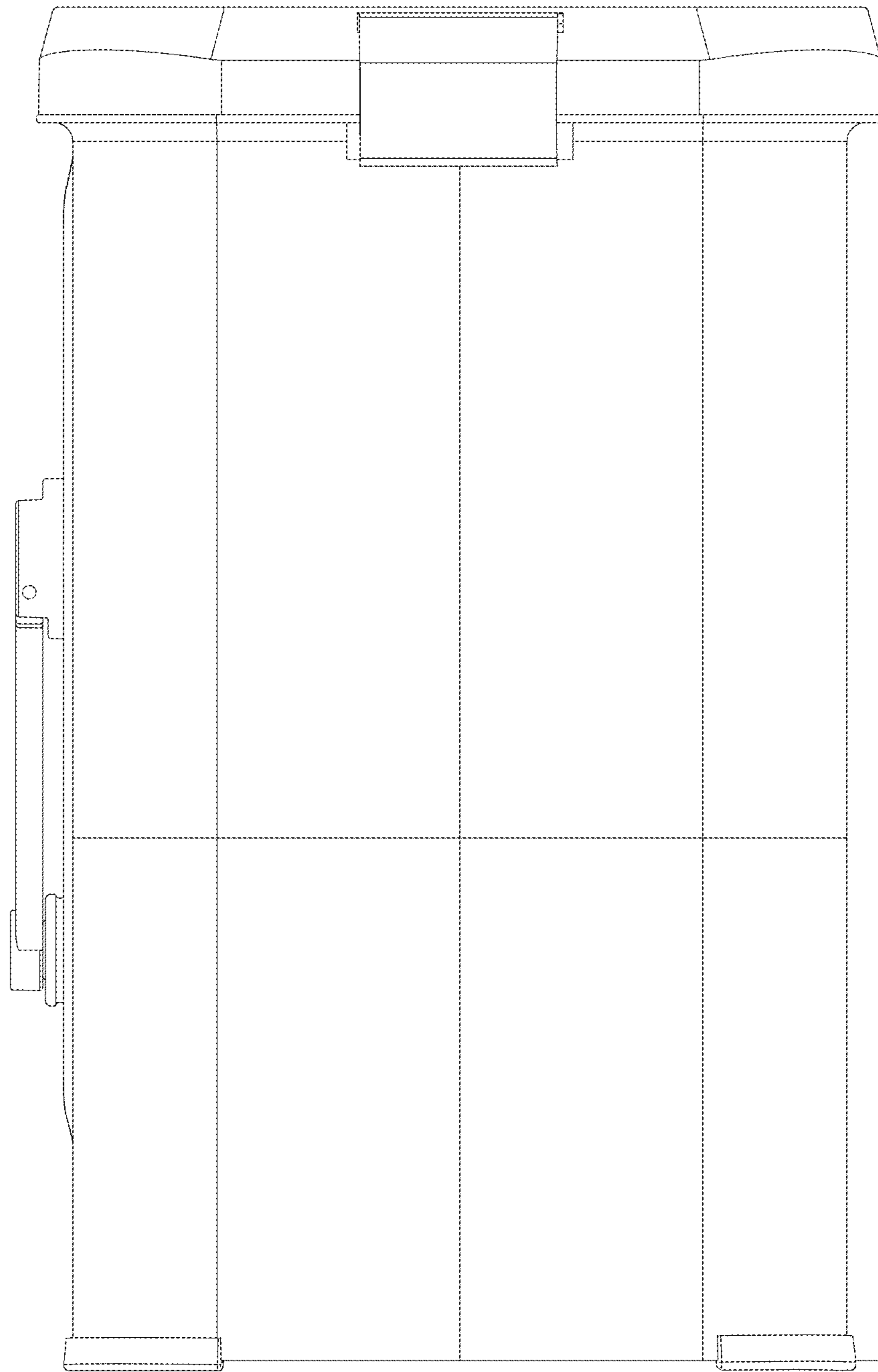

FIG. 5

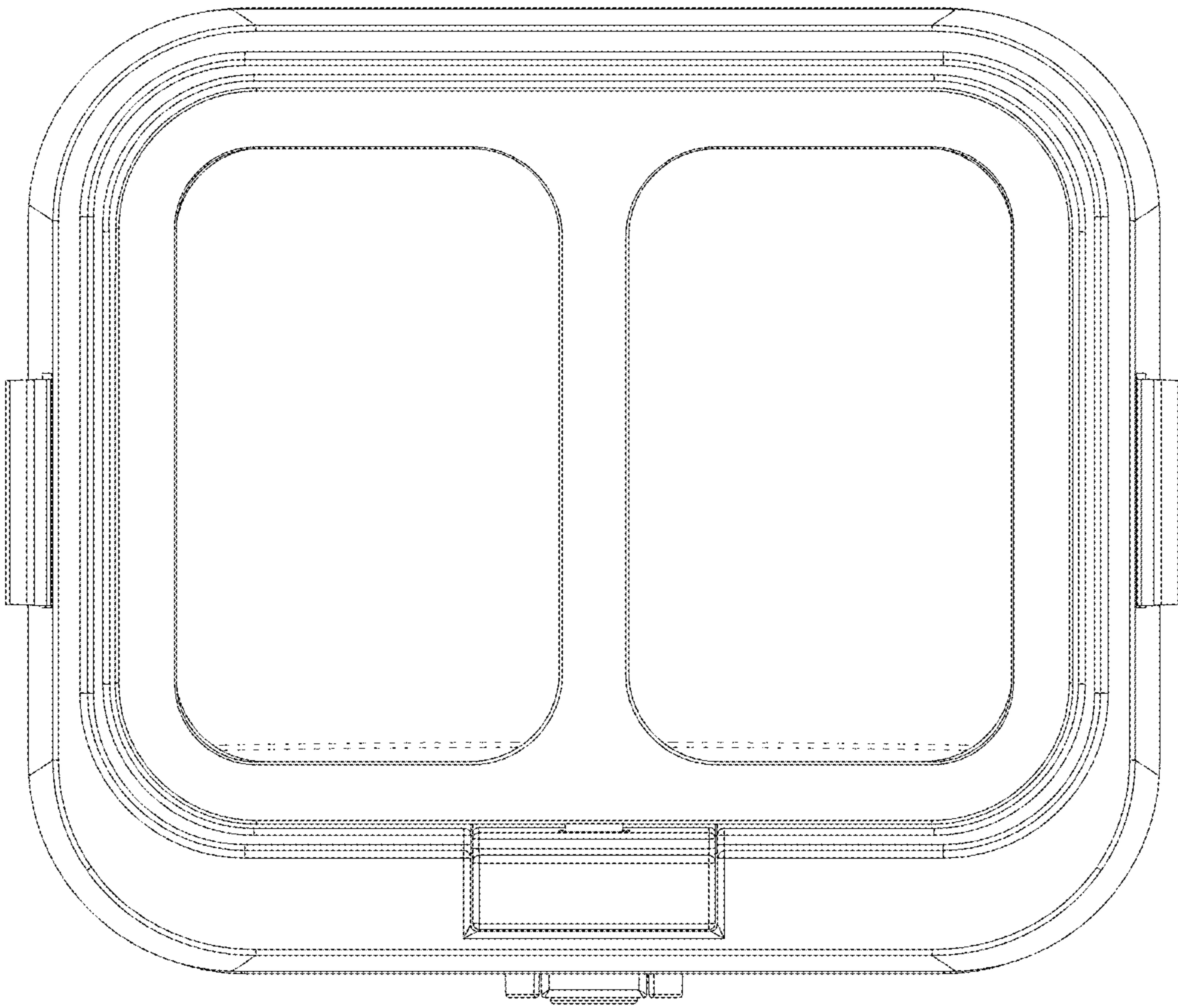

FIG. 6

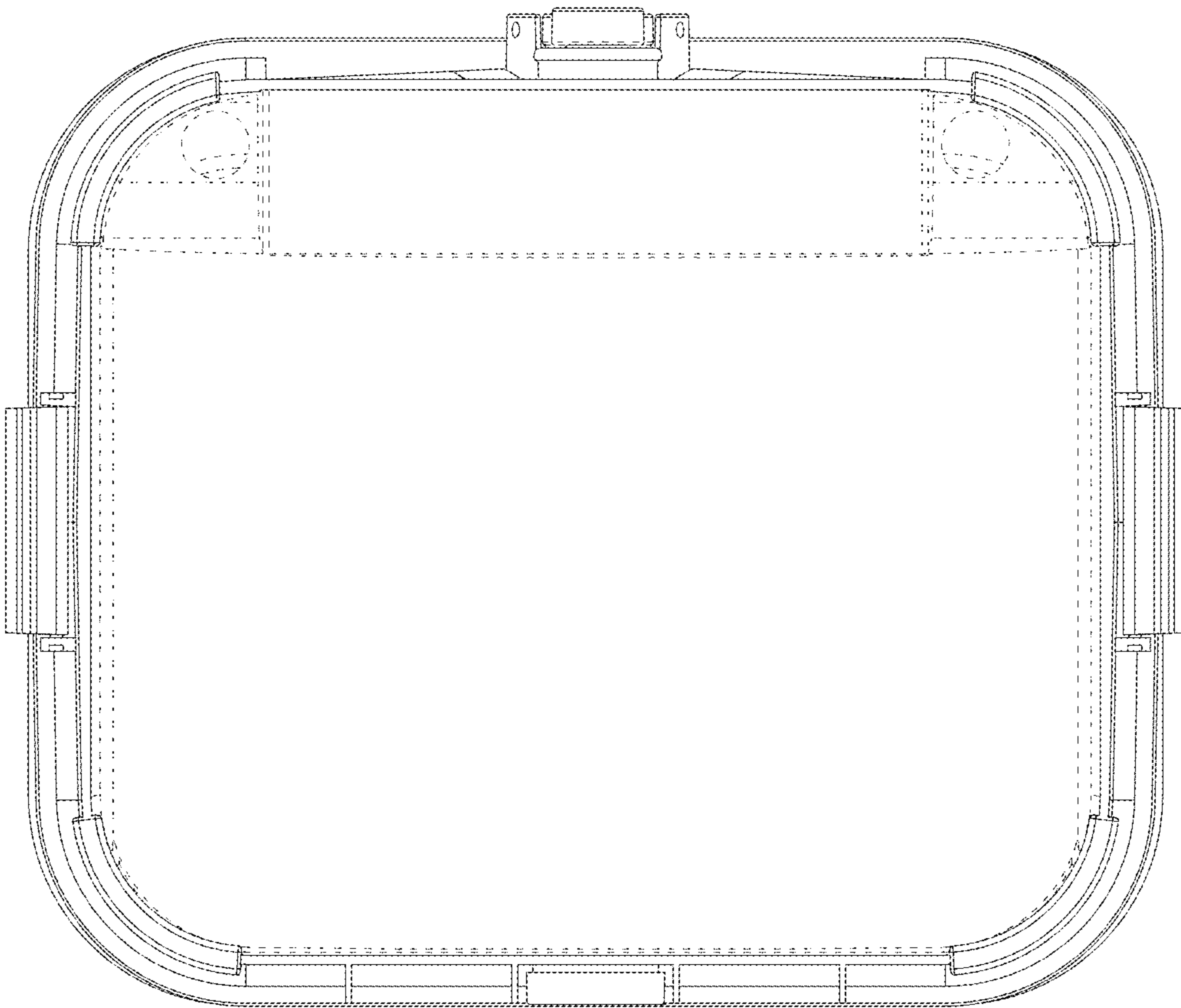

FIG. 7



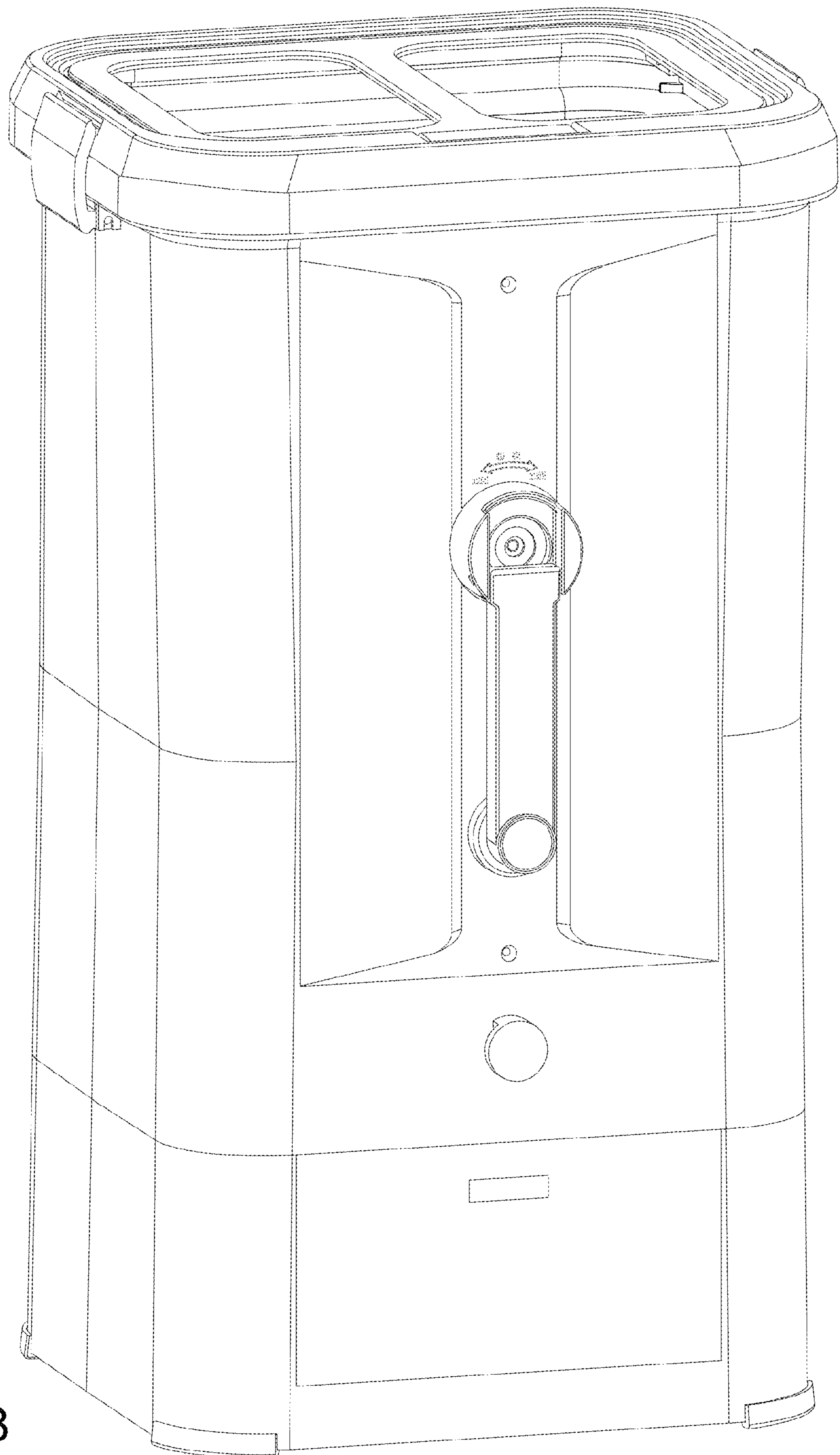

FIG. 8

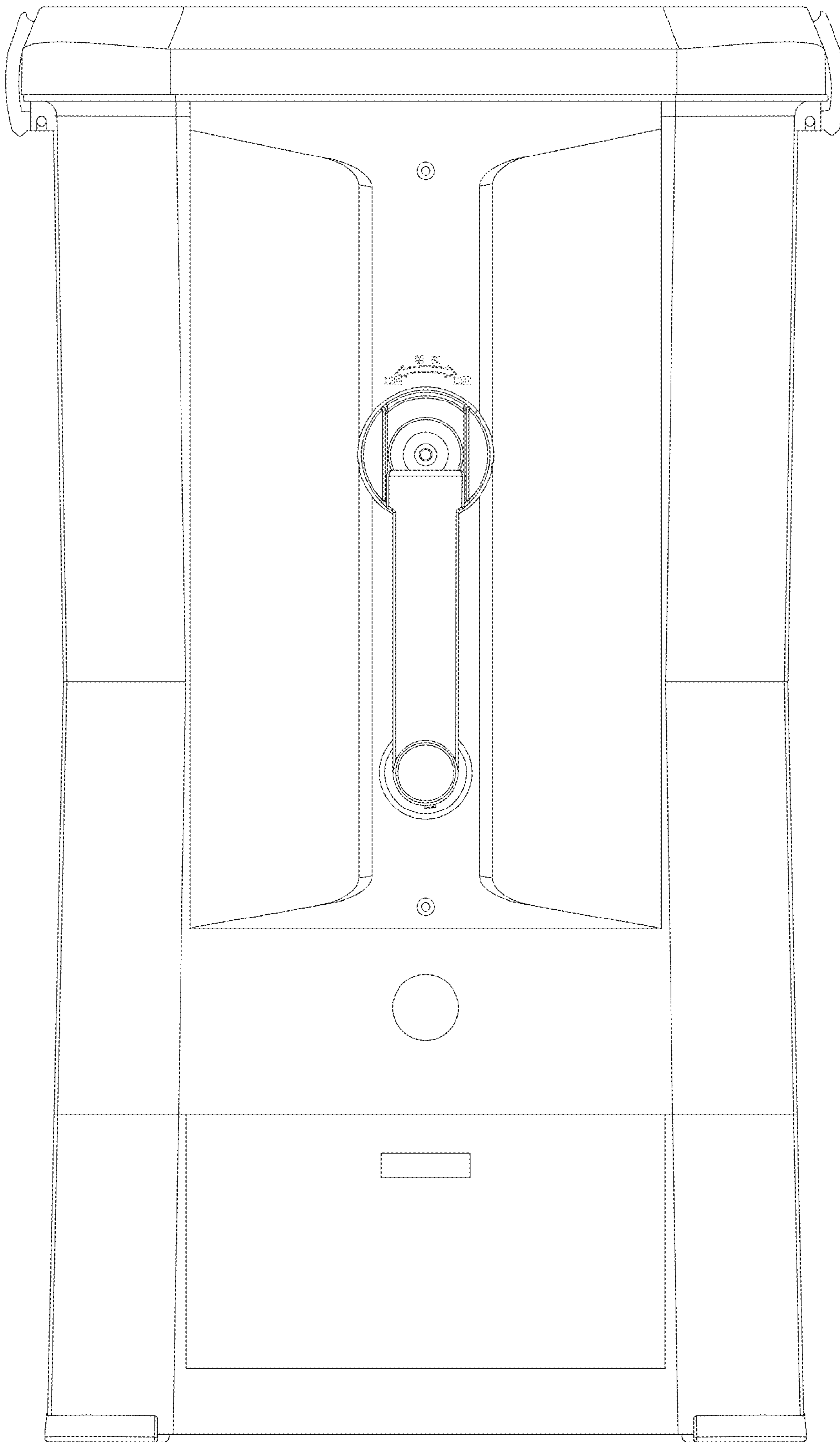

FIG. 9

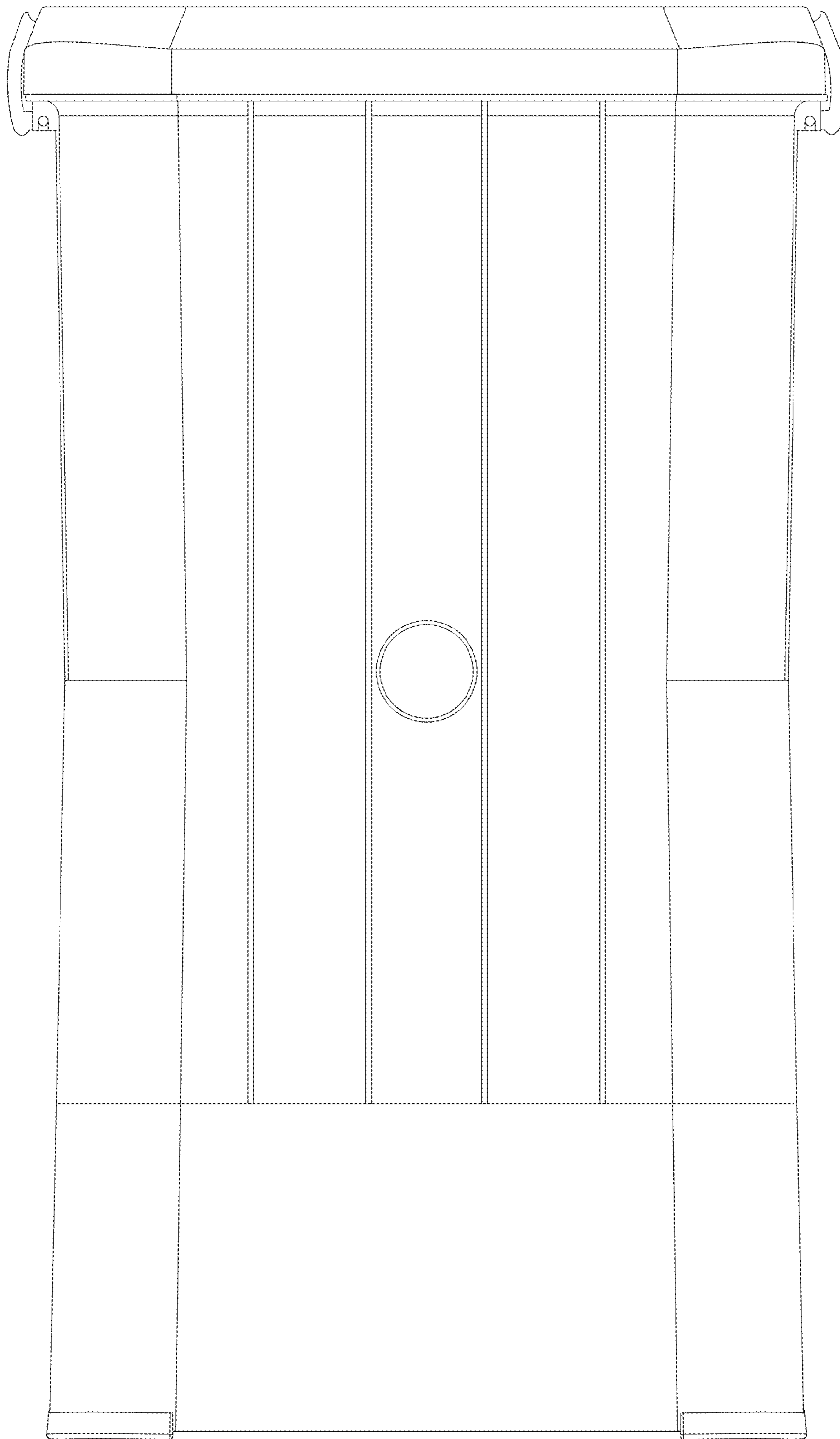

FIG. 10

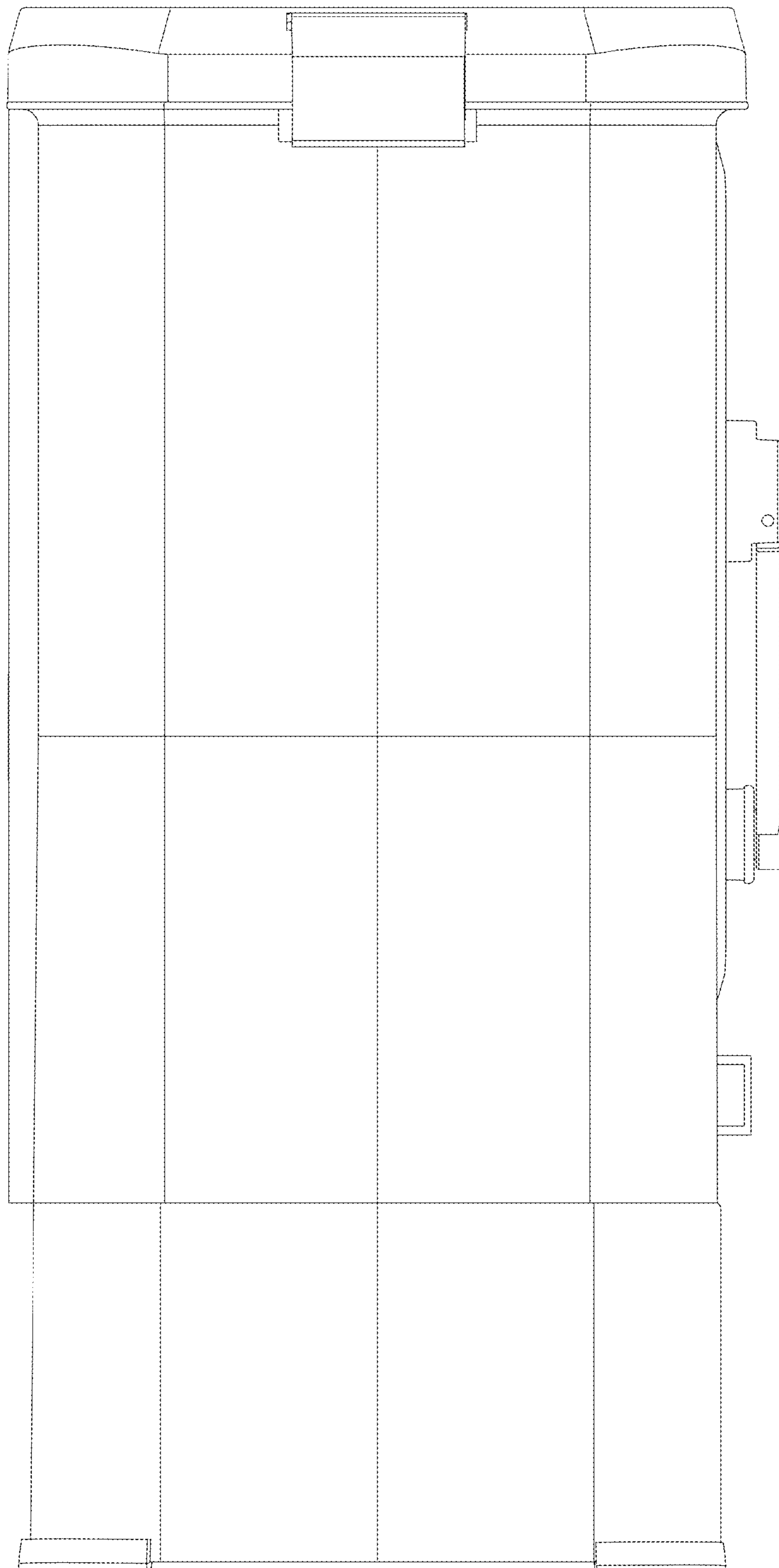

FIG. 11

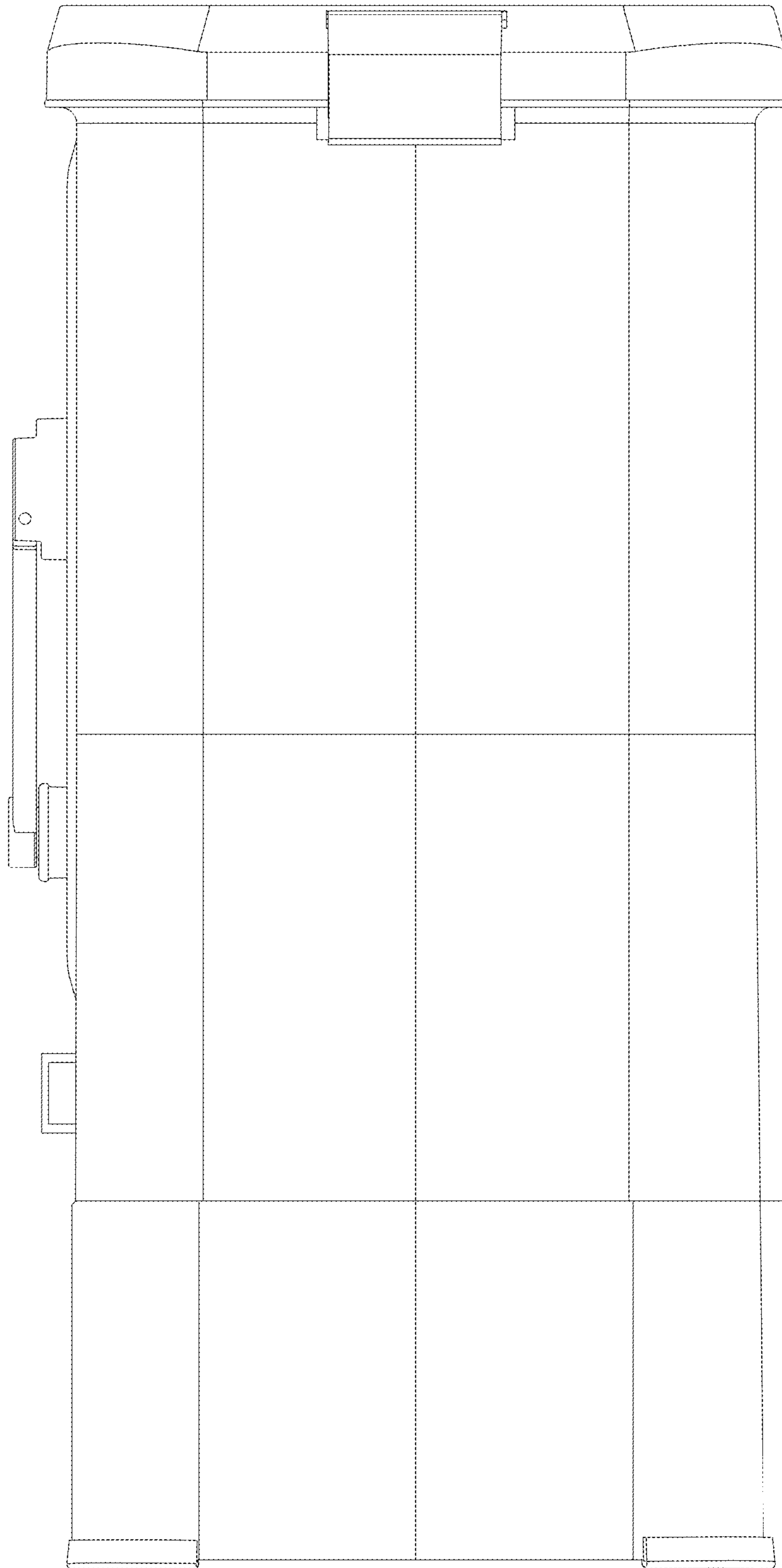

FIG. 12

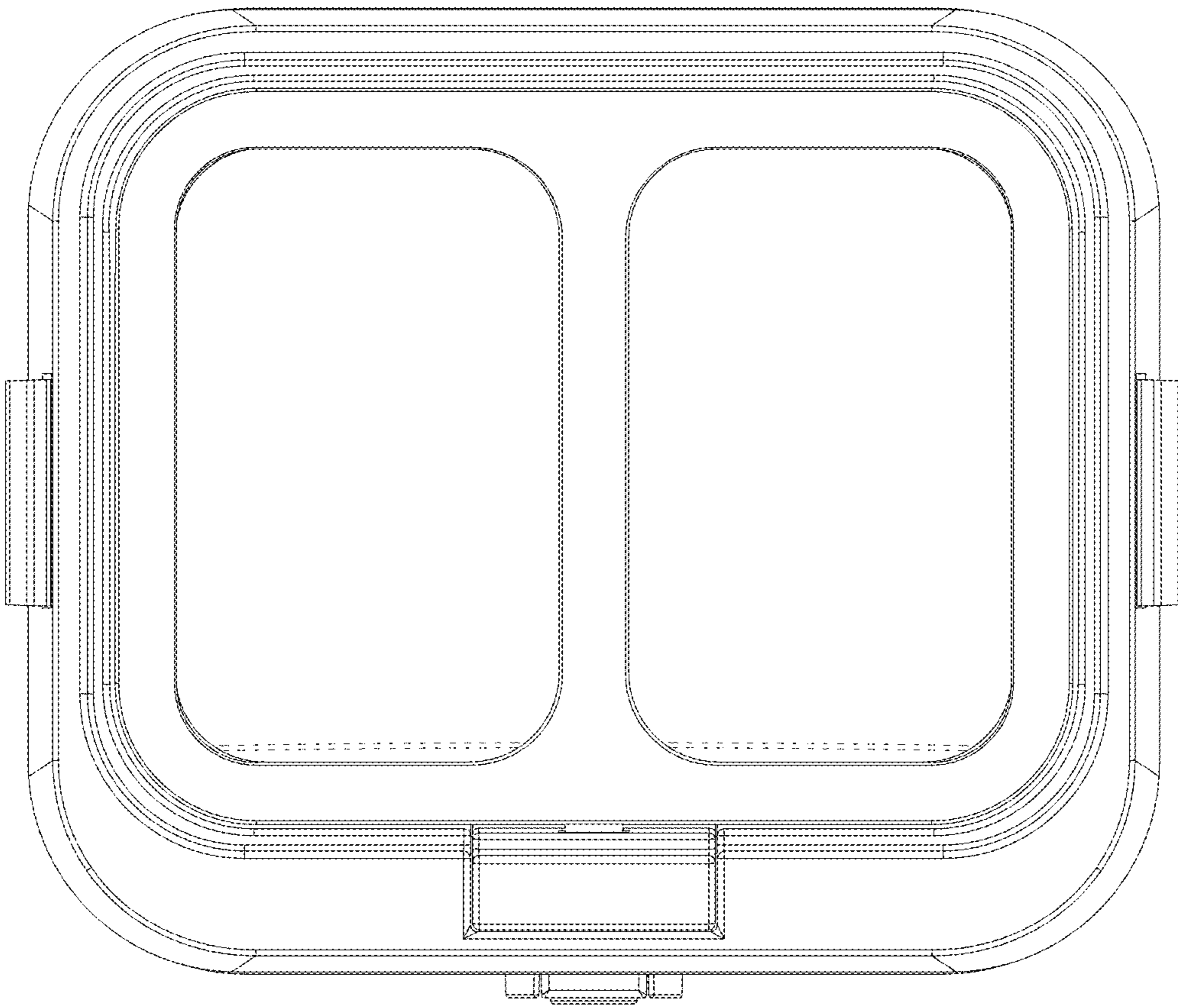

FIG. 13

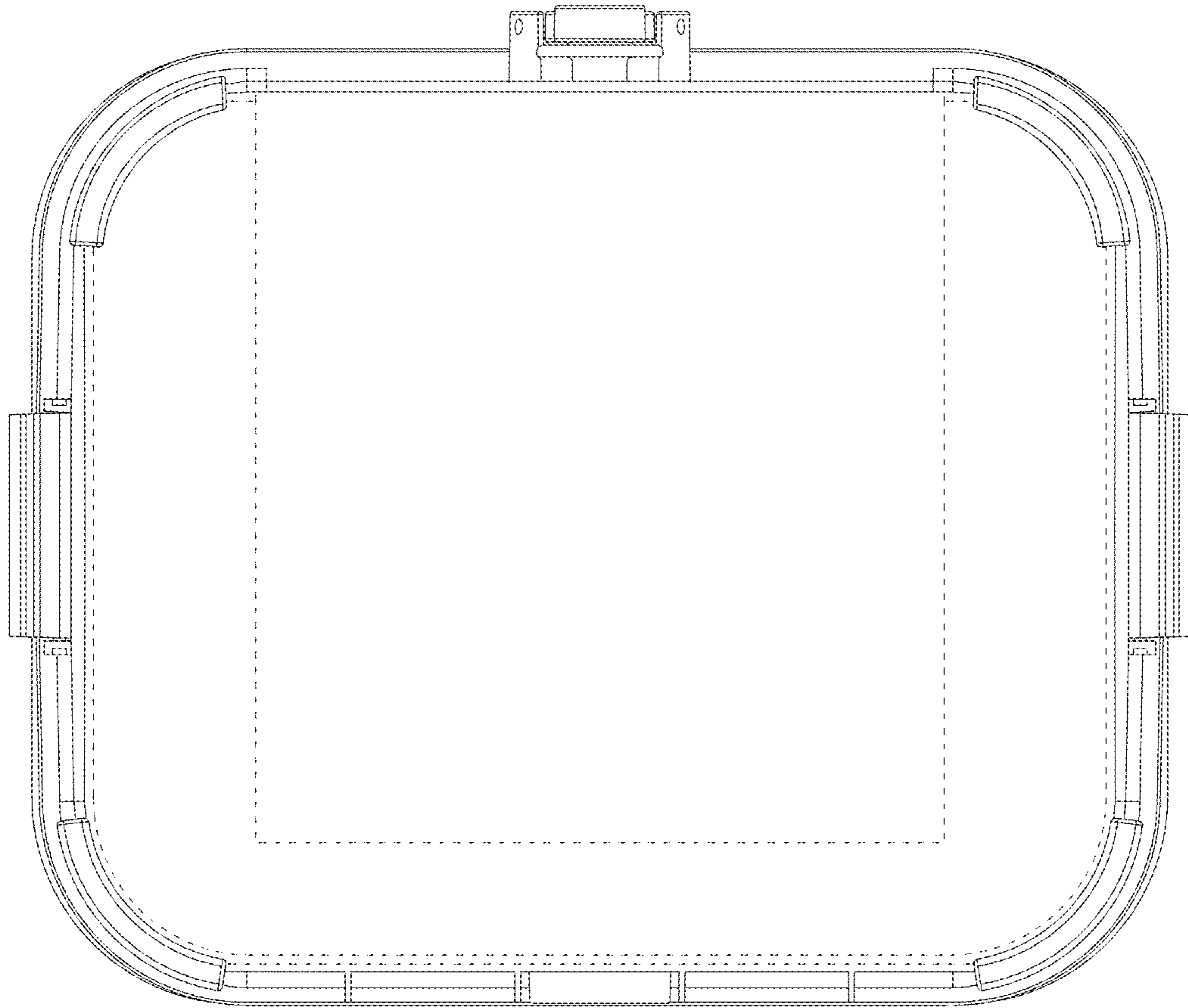

FIG. 14