



US00D961858S

(12) **United States Design Patent**  
**White**

(10) **Patent No.:** **US D961,858 S**

(45) **Date of Patent:** **\*\* Aug. 23, 2022**

(54) **VIVARIUM**

(71) Applicant: **Leslie White**, Tickton (GB)

(72) Inventor: **Leslie White**, Tickton (GB)

(\*\*) Term: **15 Years**

(21) Appl. No.: **29/822,653**

(22) Filed: **Jan. 11, 2022**

**Related U.S. Application Data**

(62) Division of application No. 29/744,669, filed on Jul. 30, 2020.

(30) **Foreign Application Priority Data**

Jan. 30, 2020 (EM) ..... 007572664-0001

Jan. 30, 2020 (EM) ..... 007572664-0002

(51) **LOC (13) Cl.** ..... **30-02**

(52) **U.S. Cl.**

USPC ..... **D30/101**

(58) **Field of Classification Search**

USPC ..... D30/101-107

CPC ..... A01K 1/00; A01K 1/0272; A01K 1/03;  
A01K 63/00; A01K 63/003

See application file for complete search history.

(56) **References Cited**

**U.S. PATENT DOCUMENTS**

D426,034 S \* 5/2000 Faulstich ..... D30/108

D571,052 S \* 6/2008 Kilroy ..... D30/104

D822,534 S \* 7/2018 Croteau ..... D11/145

D823,550 S \* 7/2018 Watson ..... D30/101

D887,086 S \* 6/2020 Huang ..... D30/101

D887,087 S \* 6/2020 Huang ..... D30/101

D922,694 S \* 6/2021 Huang ..... D30/101

\* cited by examiner

*Primary Examiner* — Sheryl Lane

*Assistant Examiner* — Aula Soroush

(74) *Attorney, Agent, or Firm* — Myers Wolin, LLC

(57) **CLAIM**

The ornamental design for a vivarium, as shown and described.

**DESCRIPTION**

FIG. 1 is a front right side perspective view of a vivarium showing our new design;

FIG. 2 is a back elevation view thereof;

FIG. 3 is a front elevation view thereof;

FIG. 4 is a left side elevation view thereof;

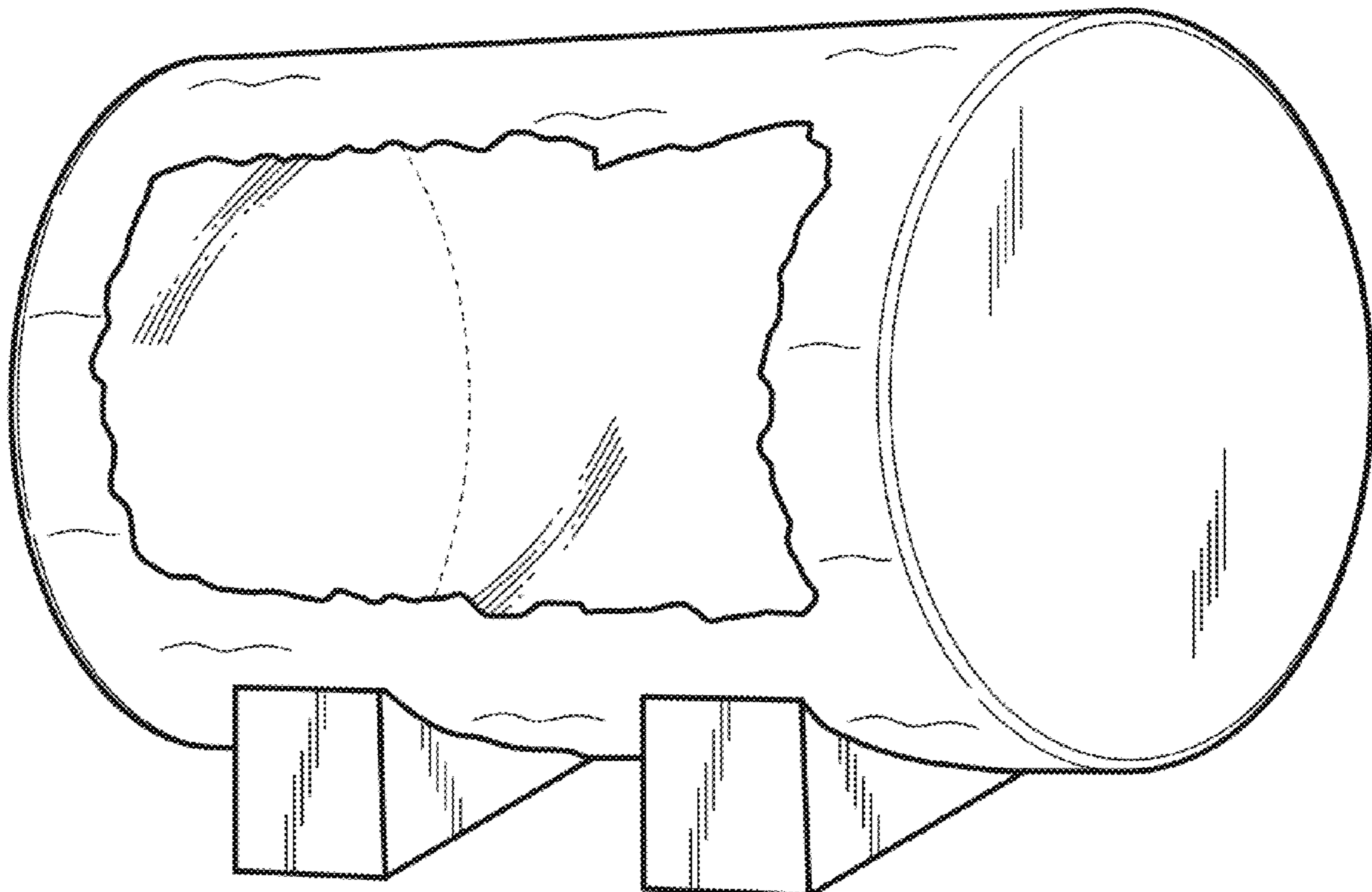
FIG. 5 is a right side elevation view thereof;

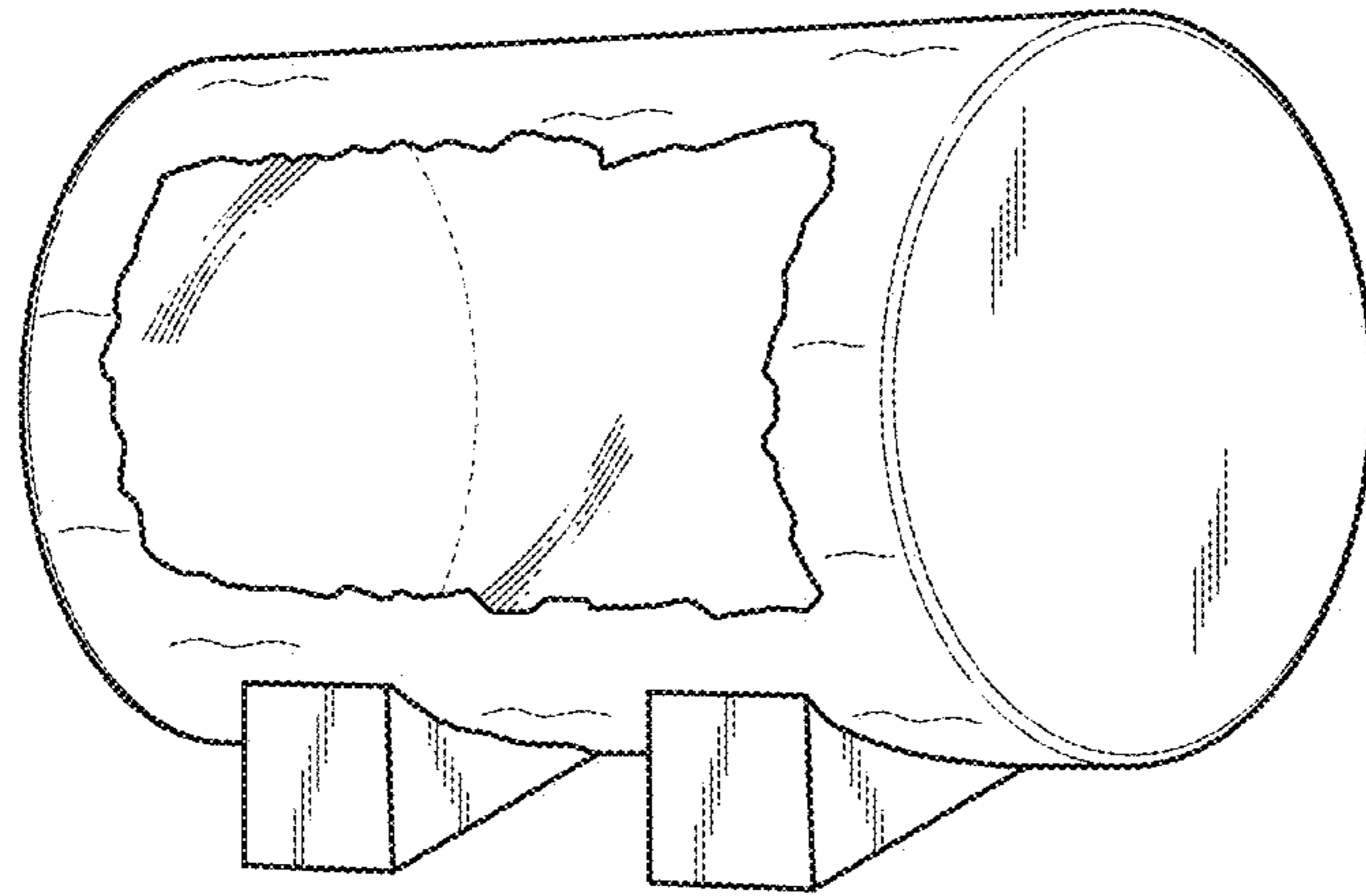
FIG. 6 is a bottom view thereof; and,

FIG. 7 is a top view thereof.

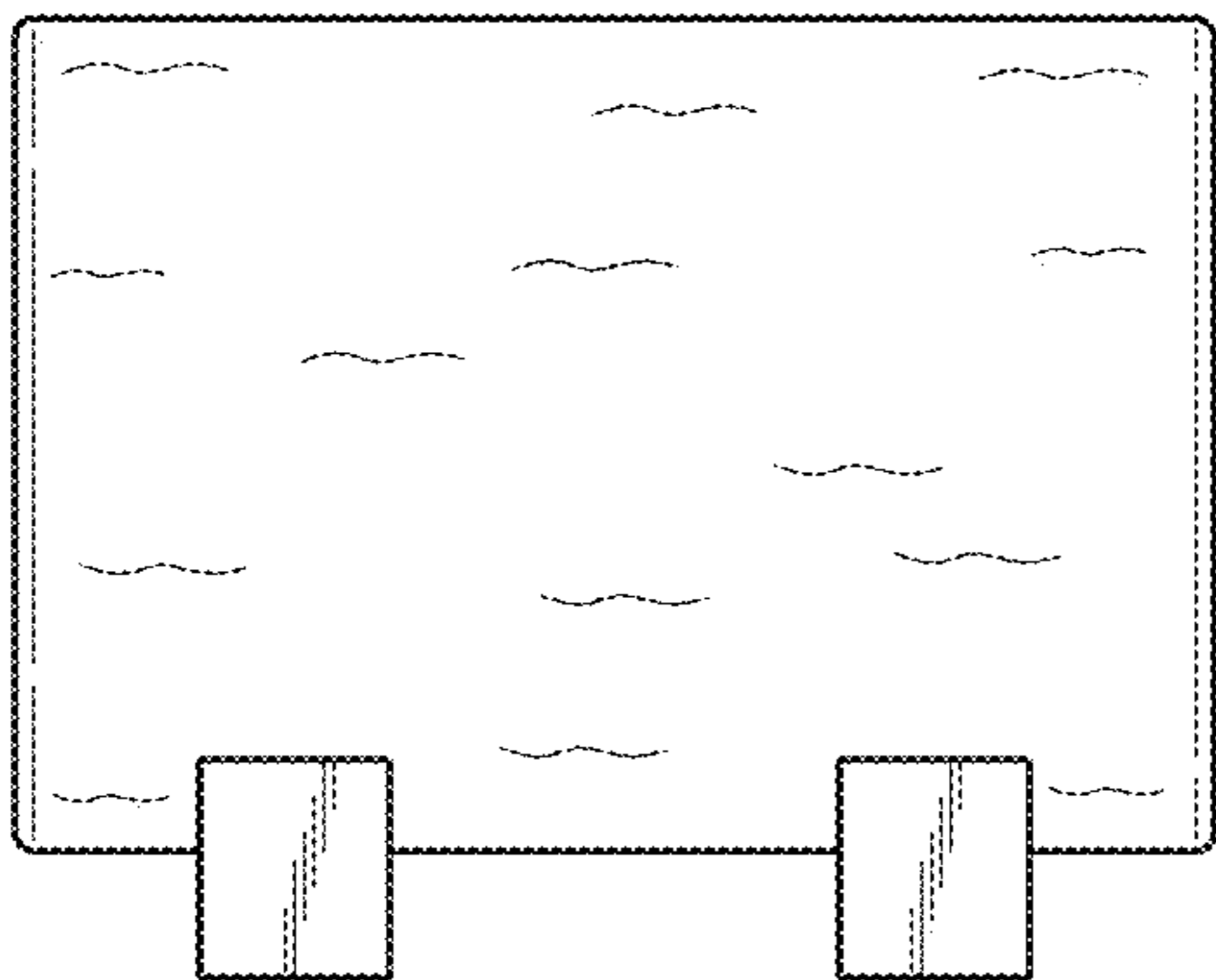
The broken lines in the drawings illustrate portions of the vivarium that form no part of the claimed design.

**1 Claim, 2 Drawing Sheets**

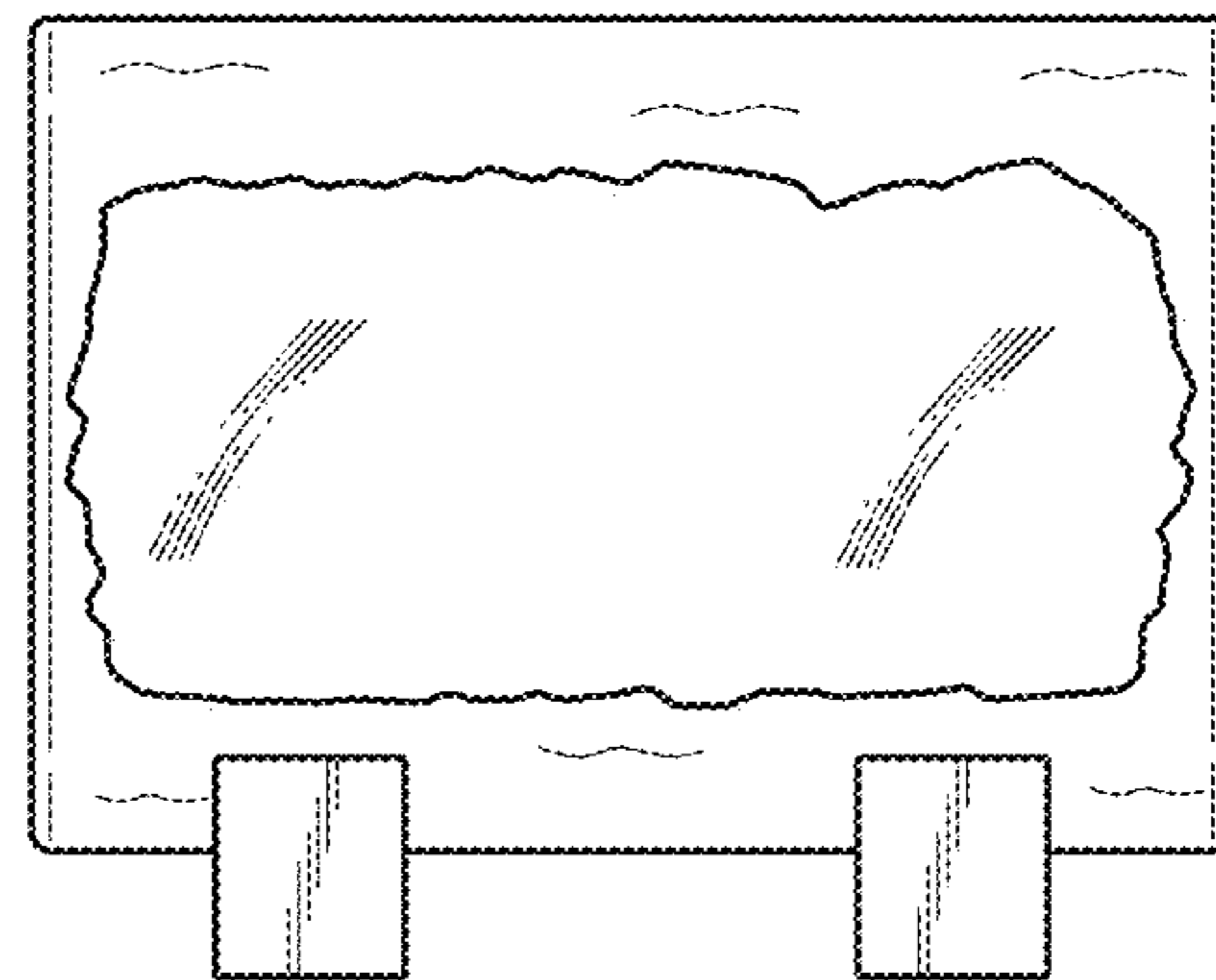




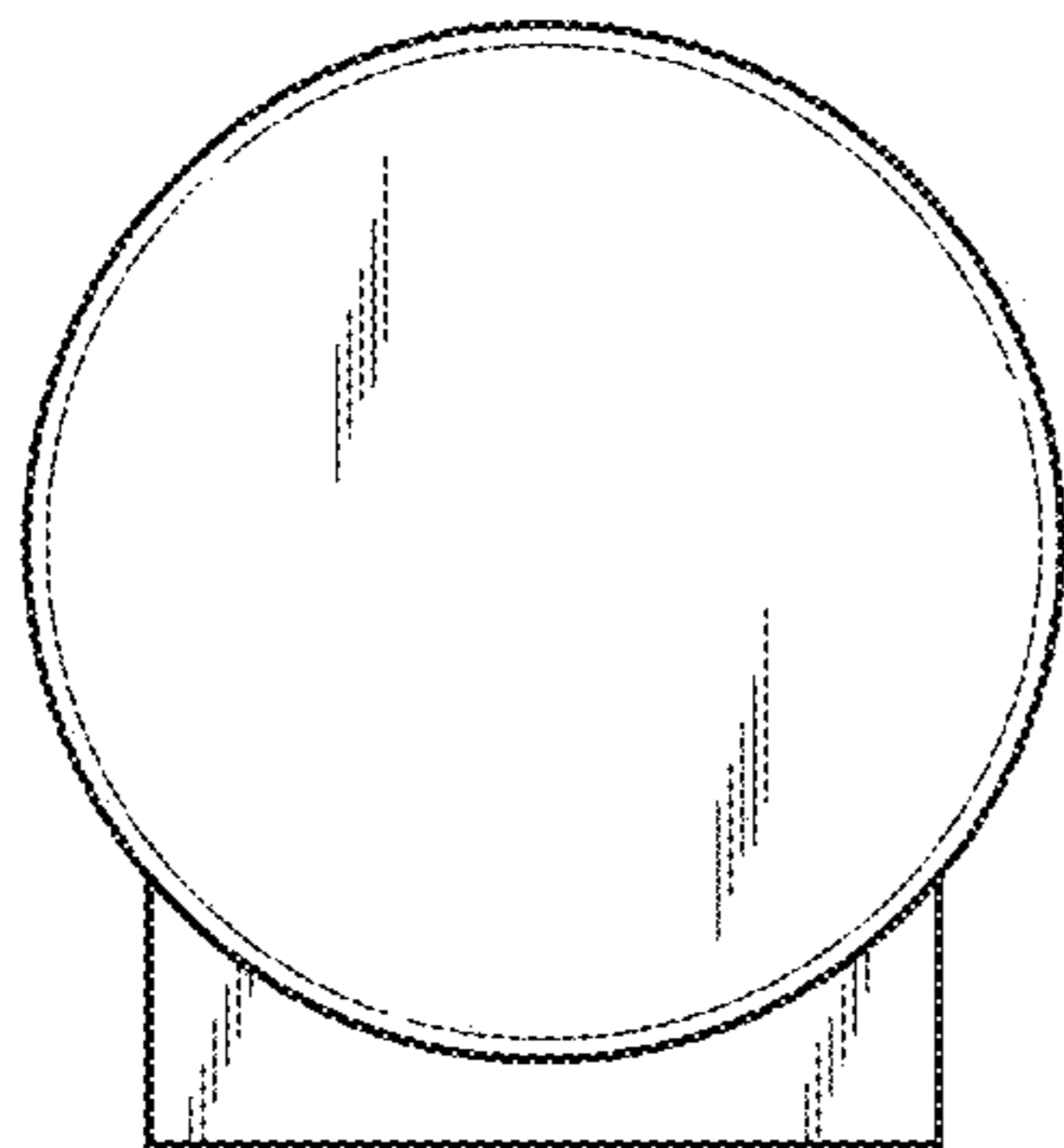
*FIG. 1*



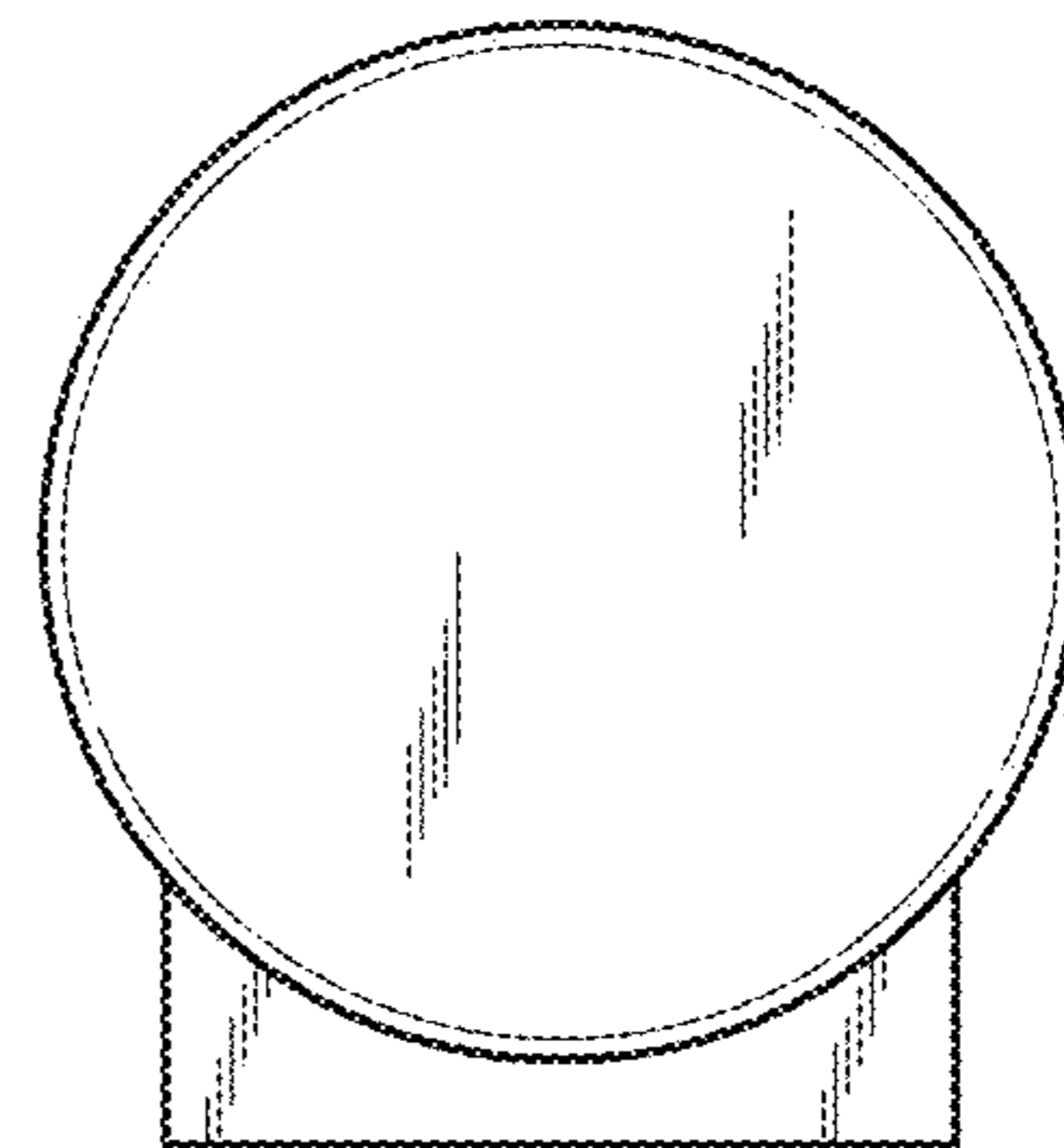
*FIG. 2*



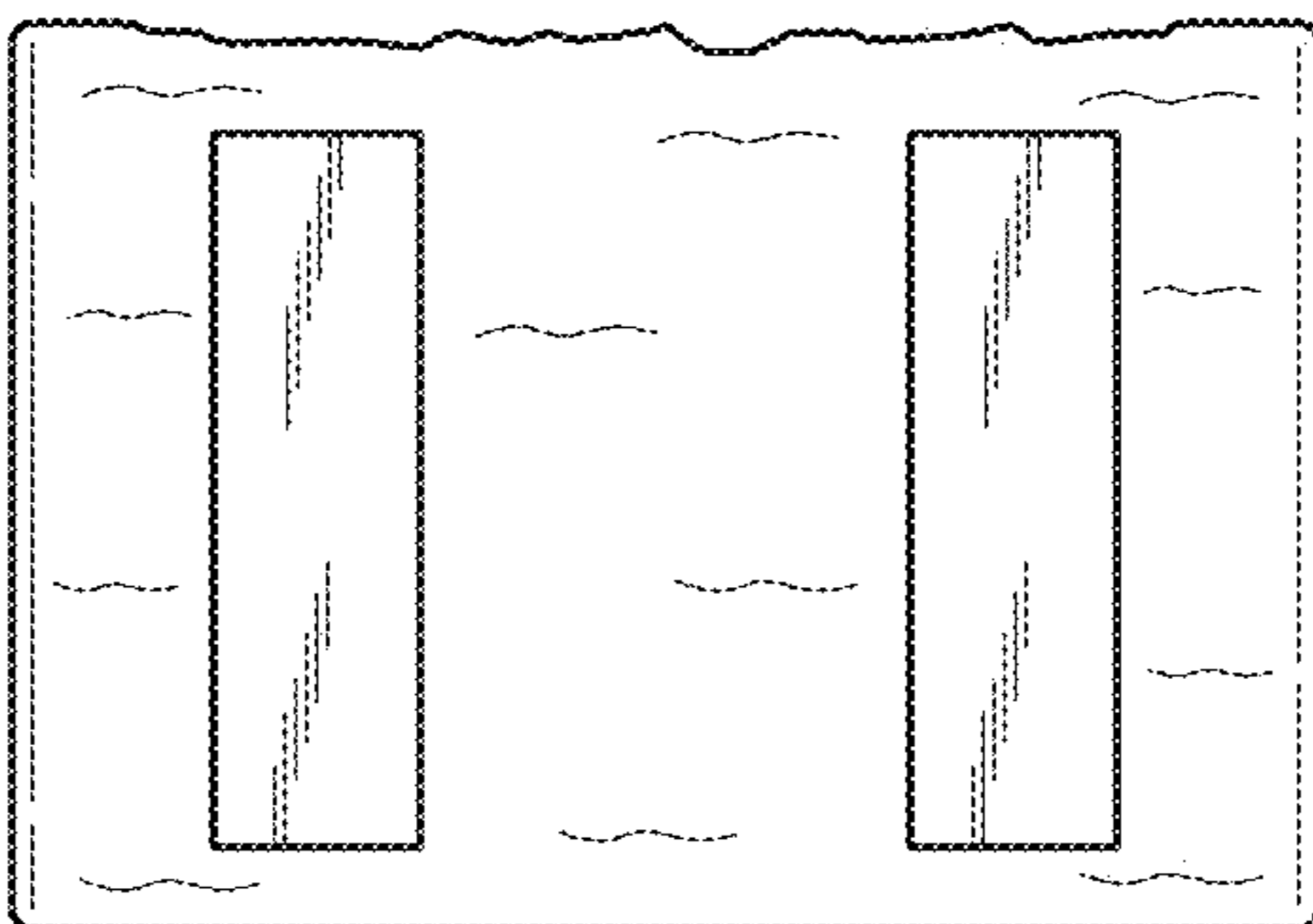
*FIG. 3*



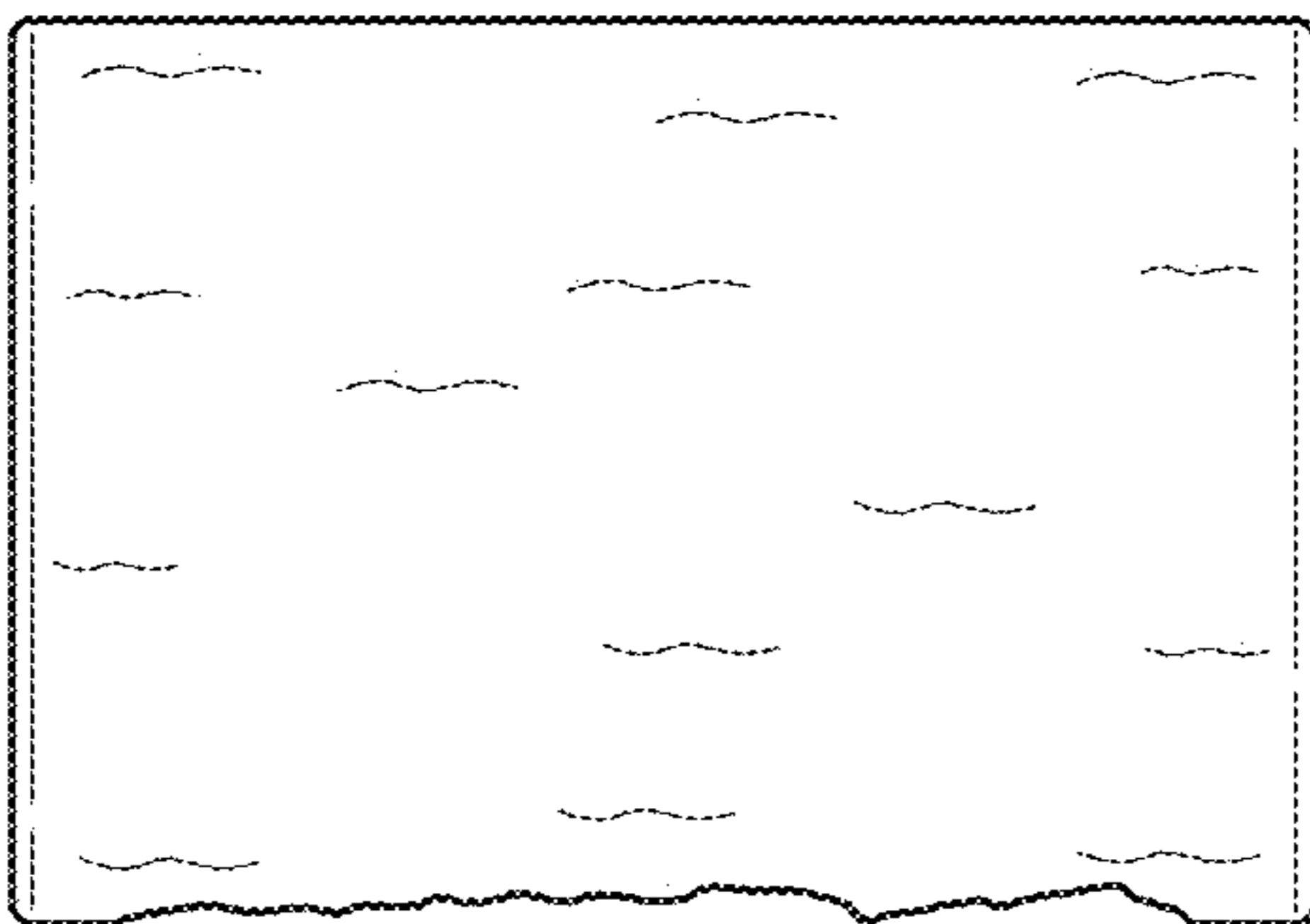
*FIG. 4*



*FIG. 5*



*FIG. 6*



*FIG. 7*