



US00D961834S

(12) **United States Design Patent**  
**Hoover et al.**

(10) **Patent No.:** **US D961,834 S**  
(45) **Date of Patent:** **\*\* Aug. 23, 2022**

(54) **LIGHTING FIXTURE**

(71) Applicant: **KOHLER CO.**, Kohler, WI (US)  
(72) Inventors: **Erin Leigh Hoover**, New York, NY (US); **Nicholas Robert Rindt**, Grafton, WI (US); **Dennis Lee Snyder**, Sheboygan, WI (US); **Seth M. Stevens**, Los Angeles, CA (US); **Maxwell Wasscher**, Grafton, WI (US); **Luke James Worth**, Sheboygan, WI (US); **Jovello Tijano Gomez, Jr.**, Sheboygan, WI (US)

(73) Assignee: **KOHLER CO.**

(\*\*) Term: **15 Years**

(21) Appl. No.: **29/744,911**

(22) Filed: **Jul. 31, 2020**

(51) **LOC (13) Cl.** ..... **26-03**

(52) **U.S. Cl.**  
USPC ..... **D26/89; D26/82; D26/123**

(58) **Field of Classification Search**  
USPC ..... D26/26, 24, 59, 72, 80, 84, 85, 89, 118, D26/128, 135, 82, 122, 123, 124, 130, D26/131

(Continued)

(56) **References Cited**

**U.S. PATENT DOCUMENTS**

1,204,023 A \* 11/1916 Johanson ..... F21V 5/00 362/334  
D51,598 S \* 12/1917 Long ..... D26/123  
(Continued)

**FOREIGN PATENT DOCUMENTS**

WO WO-2016075055 A1 \* 5/2016 ..... F21V 14/003

**OTHER PUBLICATIONS**

Kohler Arendela 15.56 in. 3-Light Polished Nickel Semi Flush Mount Model #K-29374-SF03B-SNL, Available from homedepot.com as early as Jan. 27, 2022. (Year: 2022).\*

(Continued)

*Primary Examiner* — Clare E Heflin  
(74) *Attorney, Agent, or Firm* — The Belles Group, P.C.

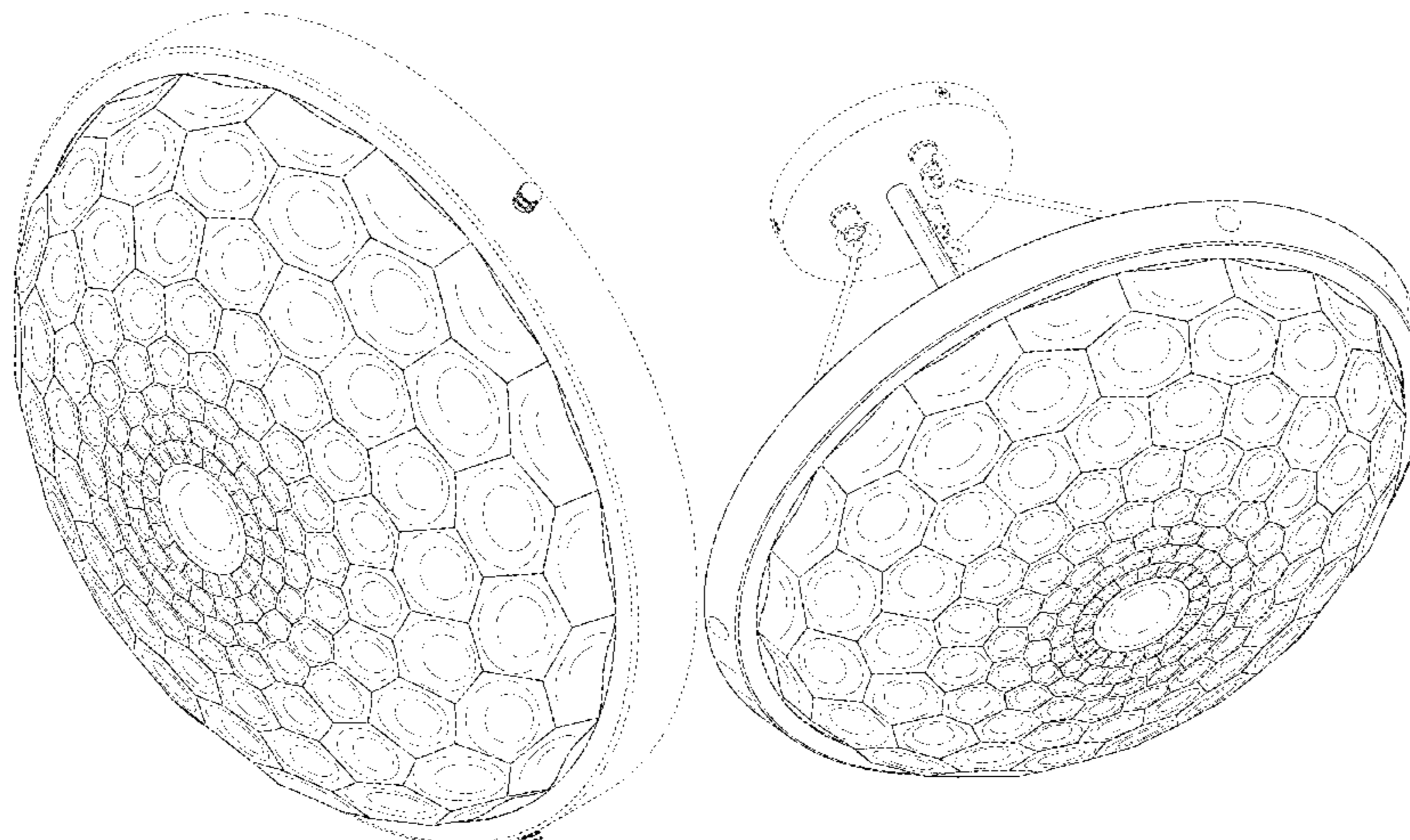
(57) **CLAIM**

We claim the ornamental design for a lighting fixture, as shown and described.

**DESCRIPTION**

FIG. 1 is a perspective view of the claimed design; FIG. 2 is a front view of the claimed design shown in FIG. 1; FIG. 3 is a rear view of the claimed design shown in FIG. 1; FIG. 4 is a side view of the claimed design shown in FIG. 1; FIG. 5 is another side view of the claimed design shown in FIG. 1; FIG. 6 is a top view of the claimed design shown in FIG. 1; FIG. 7 is a bottom view of the claimed design shown in FIG. 1; FIG. 8 is a perspective view of another embodiment of the claimed design; FIG. 9 is a front view of the claimed design shown in FIG. 8; FIG. 10 is a rear view of the claimed design shown in FIG. 8; FIG. 11 is a side view of the claimed design shown in FIG. 8; FIG. 12 is another side view of the claimed design shown in FIG. 8; FIG. 13 is a top view of the claimed design shown in FIG. 8; and, FIG. 14 is a bottom view of the claimed design shown in FIG. 8. The broken lines in the drawings depict portions of the lighting fixture that form no part of the claimed design.

**1 Claim, 12 Drawing Sheets**



- (58) **Field of Classification Search**  
 CPC ..... F21V 3/0418; F21V 3/049  
 See application file for complete search history.

(56) **References Cited**

U.S. PATENT DOCUMENTS

D52,079	S	*	6/1918	Marcus	.....	D26/123
D52,503	S	*	10/1918	Arndt	.....	D26/123
D54,095	S	*	11/1919	Johnson	.....	D26/123
D56,715	S	*	11/1920	Thompson	.....	D26/129
D73,183	S	*	8/1927	Kasch	.....	D8/310
D164,564	S	*	9/1951	Franck	.....	D26/134
D194,990	S	*	4/1963	Thomasson	.....	D26/123
D203,061	S	*	11/1965	Bushcott	.....	D26/135
D341,441	S	*	11/1993	Shapiro	.....	D26/88
D576,349	S	*	9/2008	Mair	.....	D26/154
D745,734	S	*	12/2015	Chen	.....	D26/89
D794,841	S	*	8/2017	Unnikrishnan	.....	D26/9
D814,690	S	*	4/2018	Navone	.....	D26/129
D849,983	S	*	5/2019	Neal	.....	D26/72
D873,458	S	*	1/2020	Holmes	.....	D26/59
D875,293	S	*	2/2020	Amato	.....	D26/88
10,619,822	B1	*	4/2020	Hsu	.....	F21V 5/06
D905,889	S	*	12/2020	Chen	.....	D26/72
D925,809	S	*	7/2021	Hsu	.....	D26/89
2012/0162991	A1	*	6/2012	Myers, Jr.	.....	F21V 17/04 428/542.2

OTHER PUBLICATIONS

DLIT Modern Flush Mount Crystal Ceiling Light, ASIN: B07ZT76617.  
 Available from amazon.com Jan. 10, 2020. (Year: 2020).\*

Dimpled Glass Pendant, Item F on p. 25 of the Shades of Light  
 Global Market 2017 Catalog © 2017. (Year: 2017).\*

www.amazon.com, “Karmiqi Crystal Ceiling Light, 13" 2-Light Flush Mount Light Fixture for Living Room, Bowl Shaped Chrome Finish Ceiling Lamp for Dining Room, Bedroom Kitchen Island Hallway Entryway”, Internet URL: <https://www.amazon.com/KARMIQI-Crystal-Ceiling-2-Light-Entryway/dp/B0869P7KZ5>, dated Mar. 24, 2020 (12 pages).

www.build.com, “Kalco Redding 12 Light 45" Wide LED Chandelier”, Internet URL: <https://www.build.com/product/s1796495?uid=4245536&displaypla=1>, retrieved on Mar. 9, 2022 (6 pages).

www.lampsplus.com, “Kichler Demilune 6" High Oide Bronze LED Wall Sconce”, Internet URL: [https://www.lampsplus.com/sfp/16T26/7cm\\_mmc=GOO-SH--Na--Na--16T26&sourceid=DFGPD16T26&gclid=EAIALQobChMli7KNt-O59gIVC8zICh13wwJwEAwYAiABEgLEfD\\_BwE](https://www.lampsplus.com/sfp/16T26/7cm_mmc=GOO-SH--Na--Na--16T26&sourceid=DFGPD16T26&gclid=EAIALQobChMli7KNt-O59gIVC8zICh13wwJwEAwYAiABEgLEfD_BwE), retrieved on Mar. 9, 2022 (5 pages).

www.lowes.com, “Kichler Kona Cay 2-Light 12-in Distressed Antique White Incandescent Semiflush Mount Light”, Internet URL: <https://www.lowes.com/pd/Kichler-Kona-Cay-12-in-Distressed-Antique-White-Coastal-Incandescent-Semi-flush-Mount-Light/1000682861>, dated Mar. 11, 2020 (5 pages).

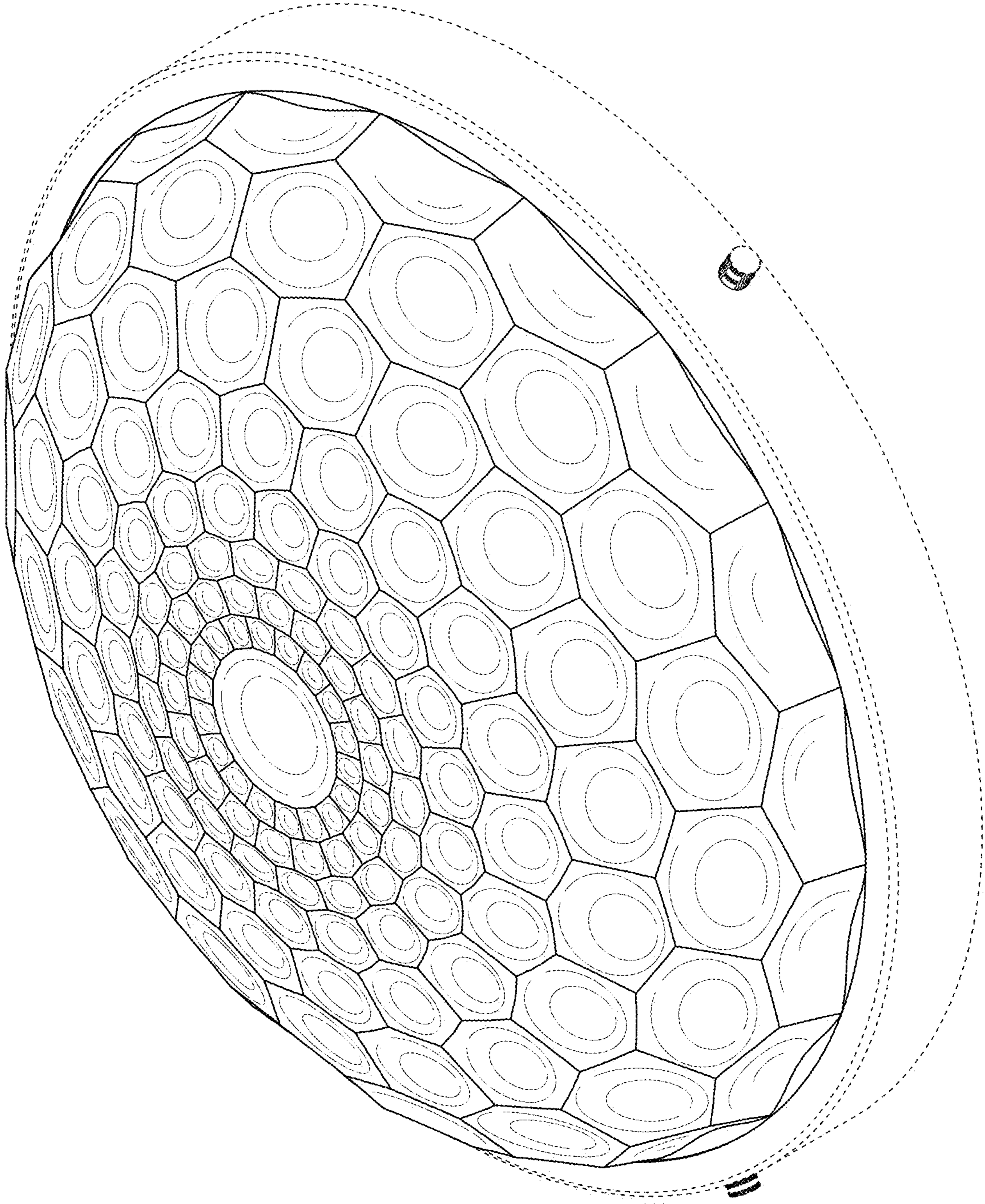
www.lowes.com, “Kichler Krystal Ice 1-Light 9.63-in Chrome Halogen Semi-flush Mount Light”, Internet URL: <https://www.lowes.com/pd/Kichler-Krystal-Ice-9-63-in-Chrome-Modern-Contemporary-Halogen-Semi-flush-Mount-Light/50356092>, dated Jul. 6, 2018 (4 pages).

www.target.com, “(2pk) 13" Elipse Crystal Flush Mount Ceiling Light White—Elegant Designs”, Internet URL: <https://www.target.com/p/2pk-13-34-ellipse-crystal-flush-mount-ceiling-light-white-elegant-designs/-/A-54334924>, retrieved on Mar. 9, 2022 (8 pages).

www.wayfair.com, “Tewkesbury 3—Light 16" Unique/Statement Dome Semi Flush Mount”, Internet URL: <https://www.wayfair.com/lighting/pdp/world-menagerie-tewkesbury-3-light-16-semi-flush-mount-w000875308.html?piid=1648246021>, retrieved on Mar. 9, 2022 (9 pages).

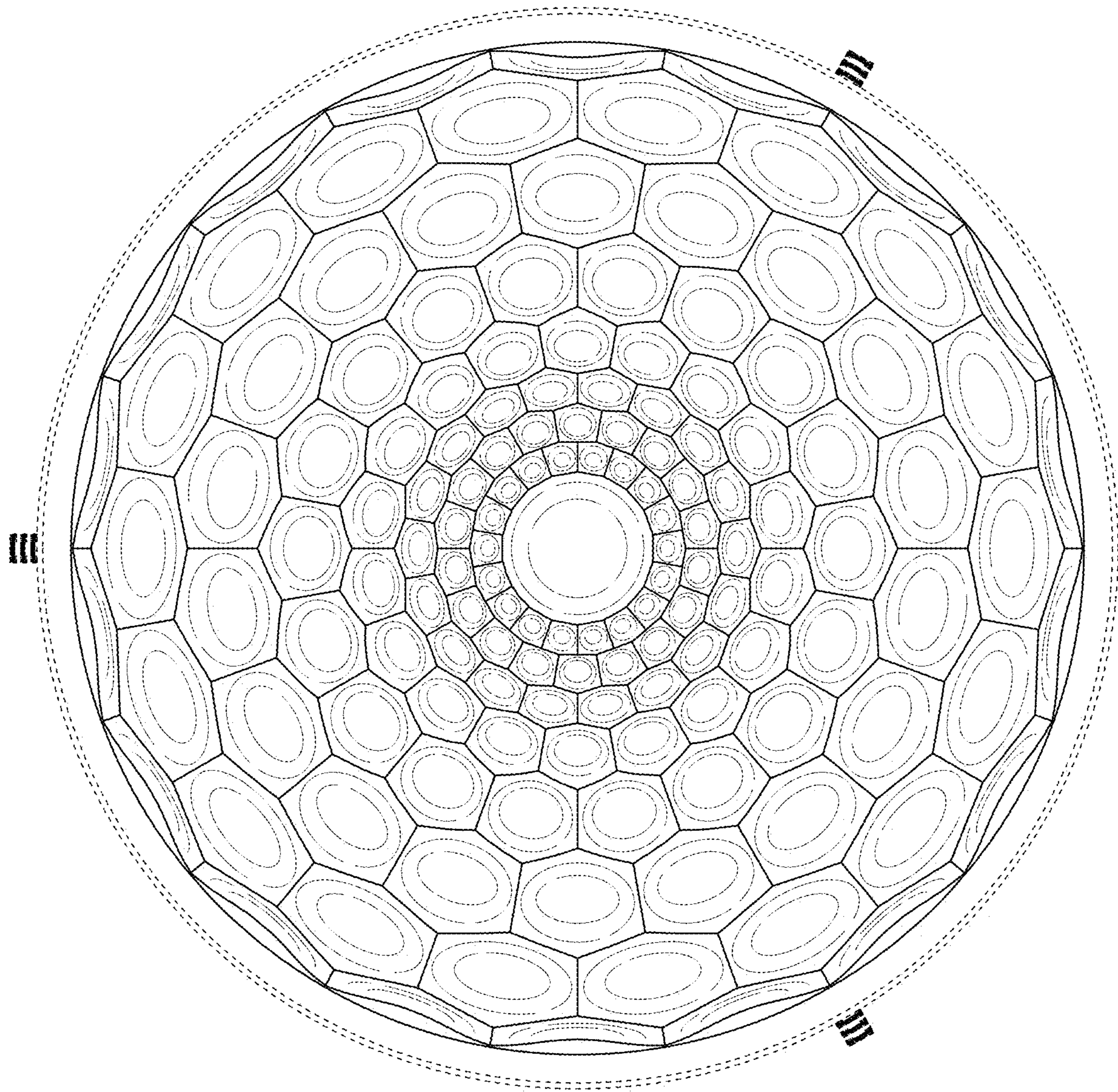
\* cited by examiner



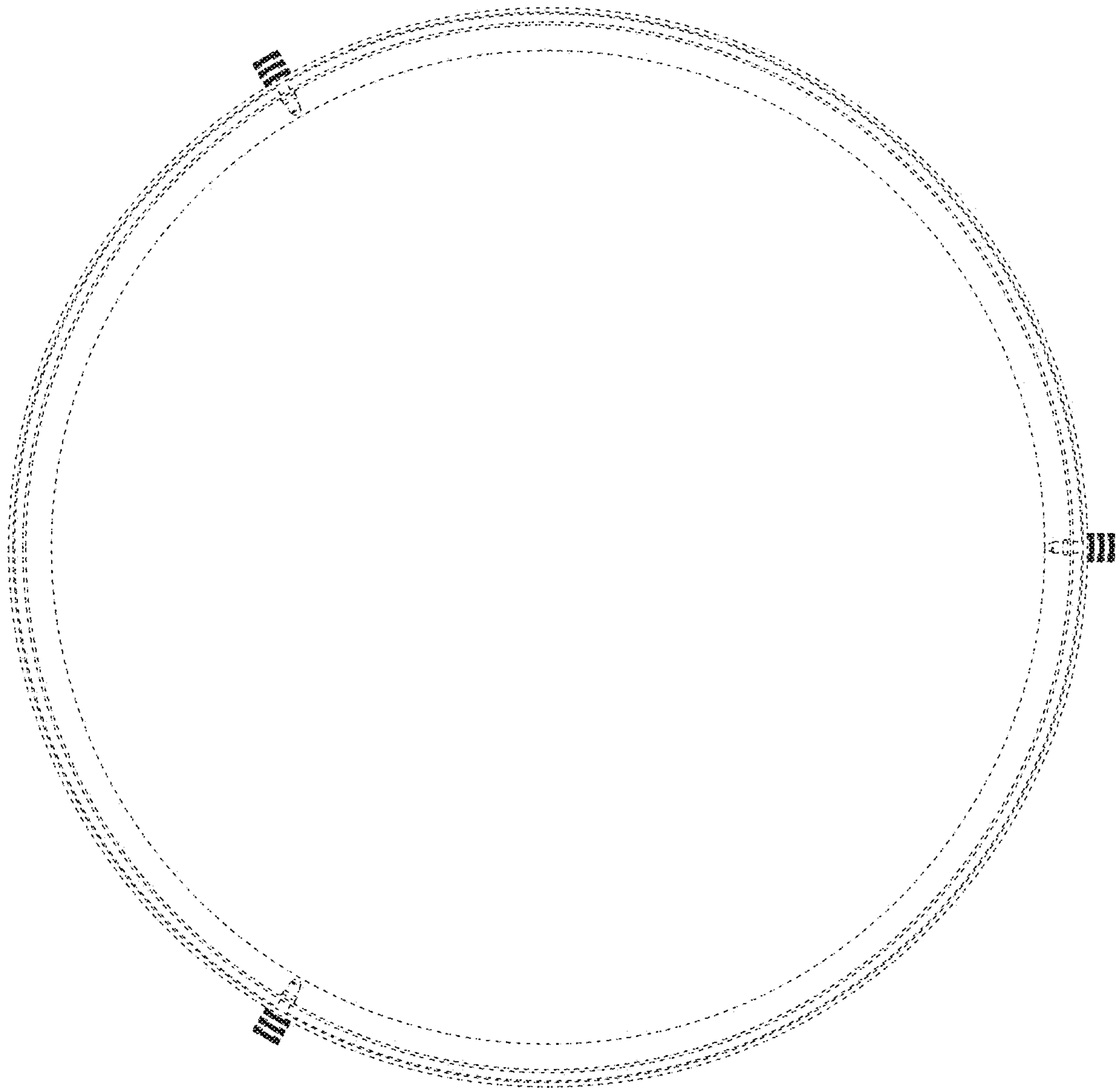


**FIG. 1**

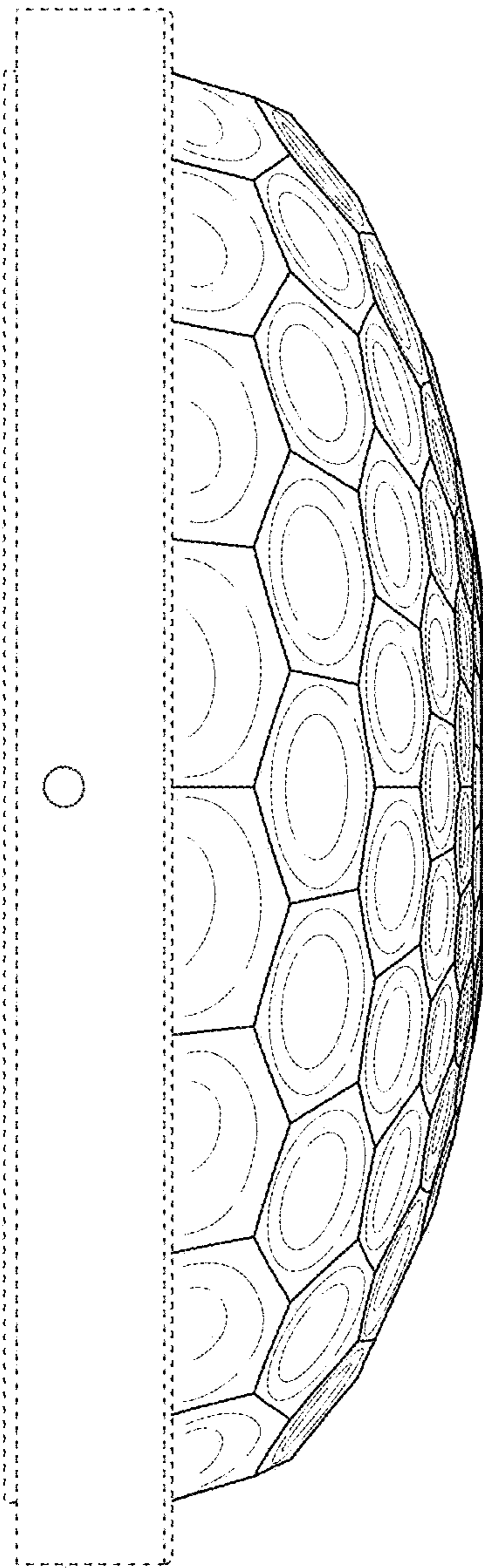




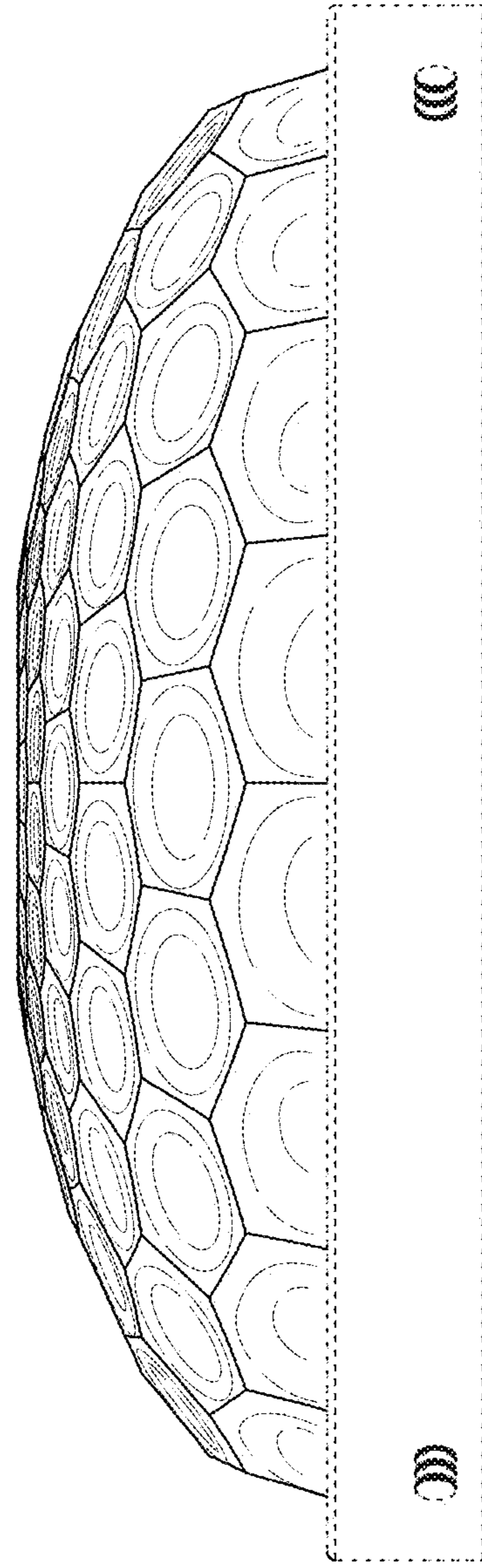
**FIG. 2**



**FIG. 3**

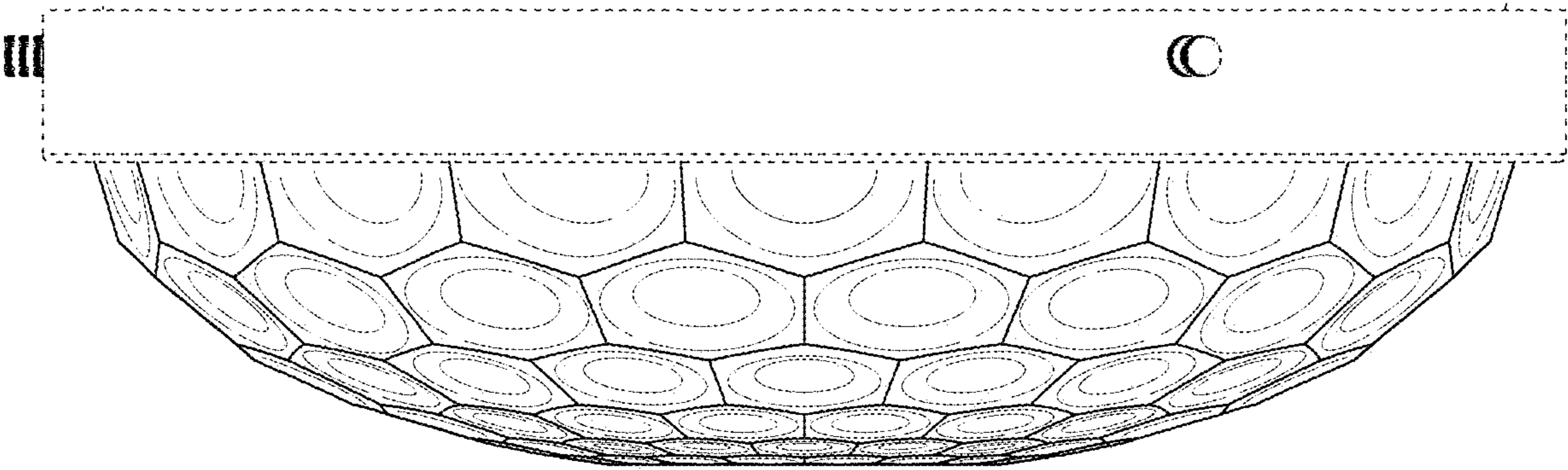


**FIG. 4**

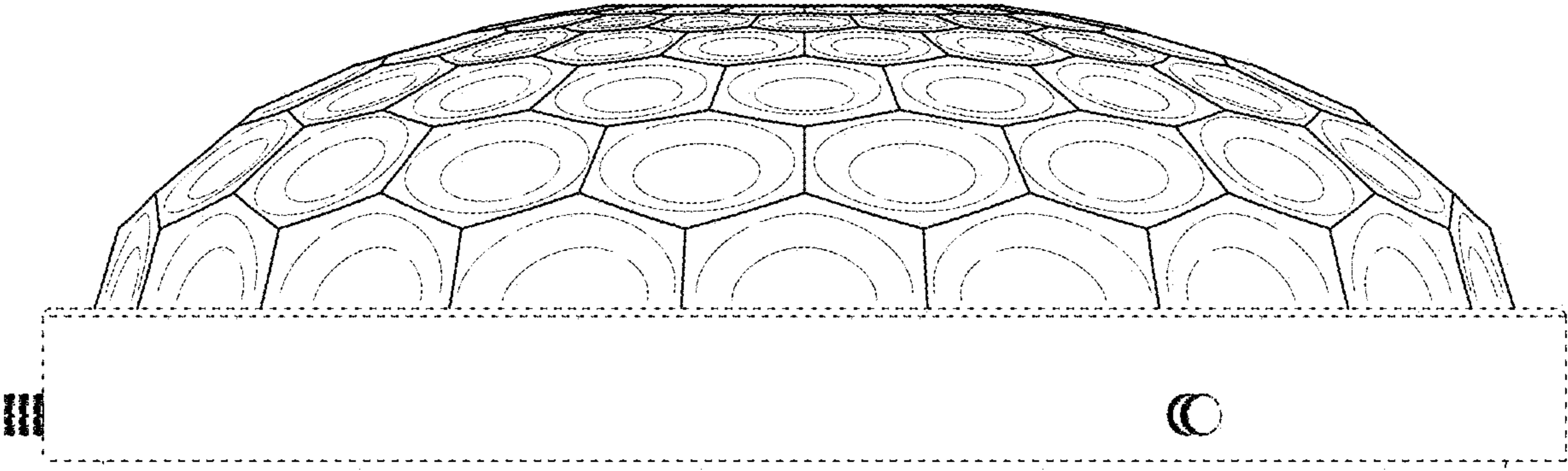


**FIG. 5**

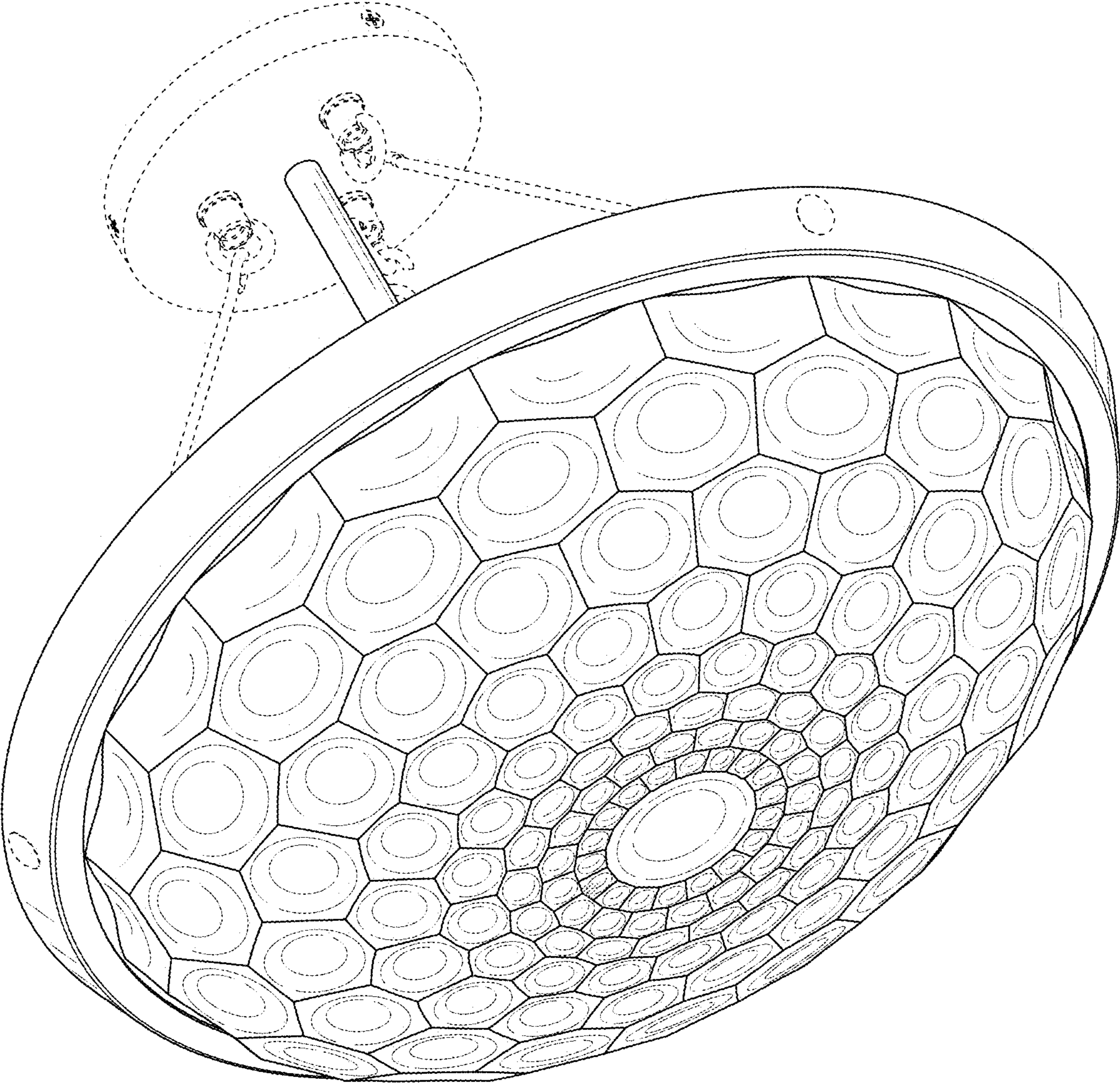




**FIG. 6**

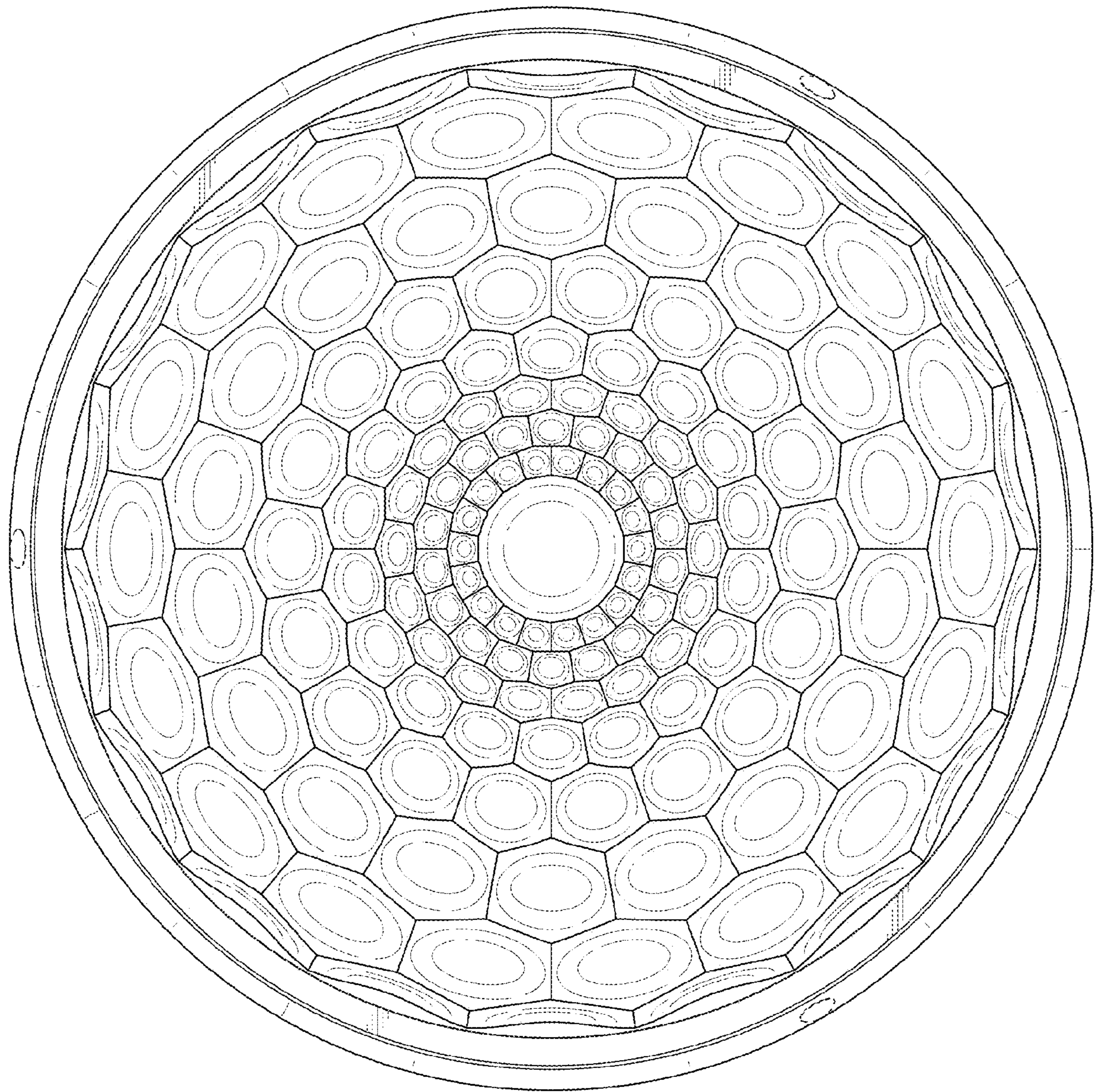


**FIG. 7**

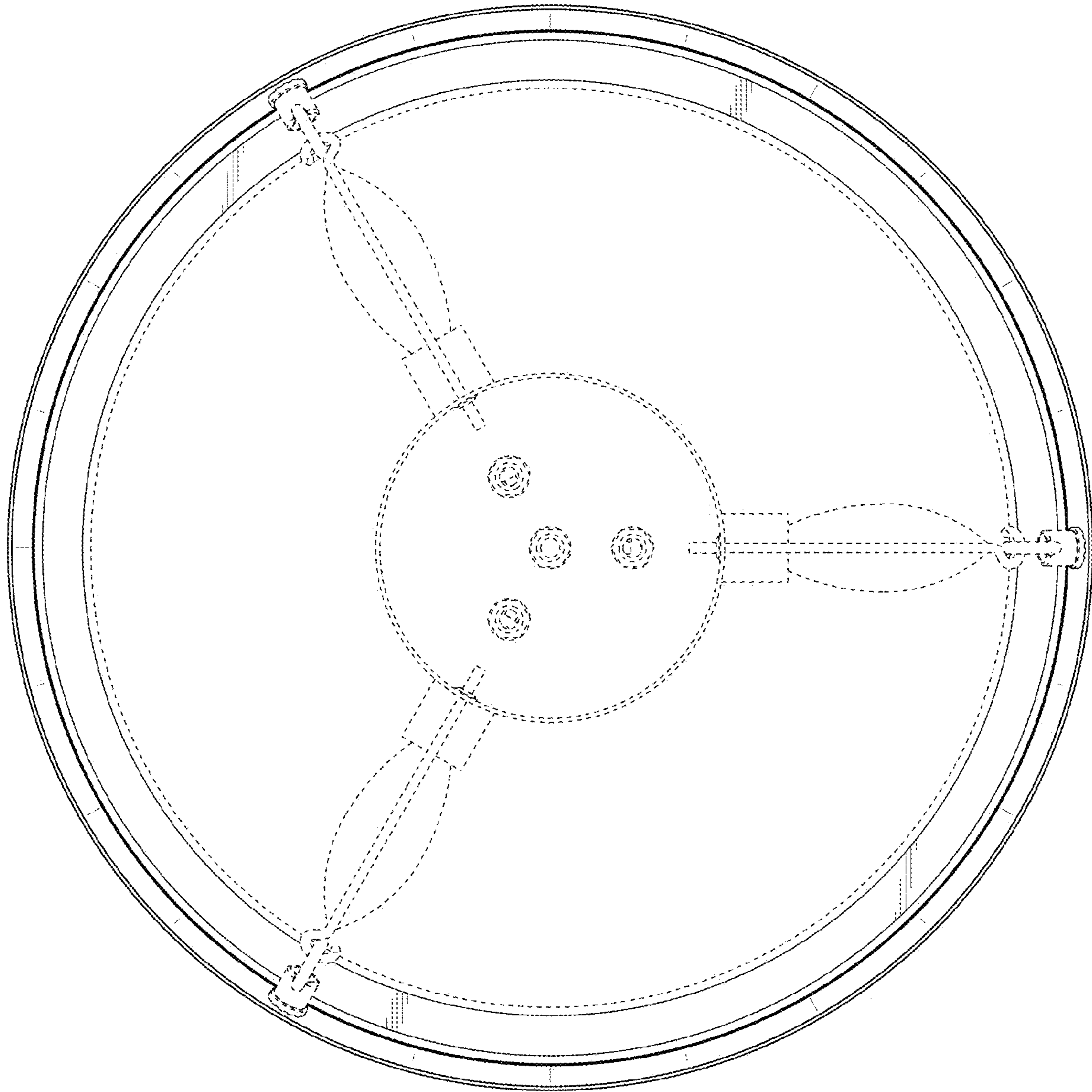


**FIG. 8**





**FIG. 9**



**FIG. 10**



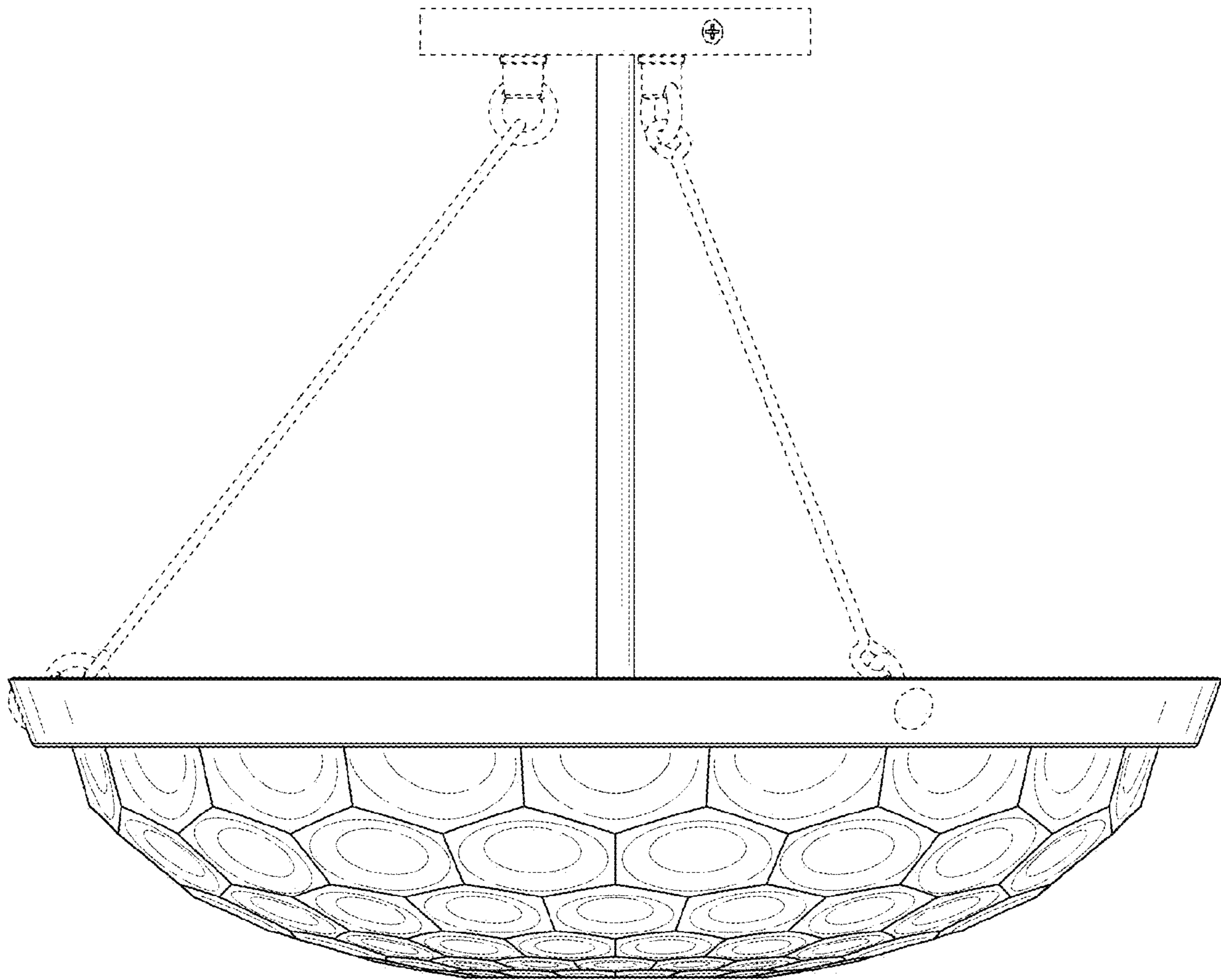


FIG. 11

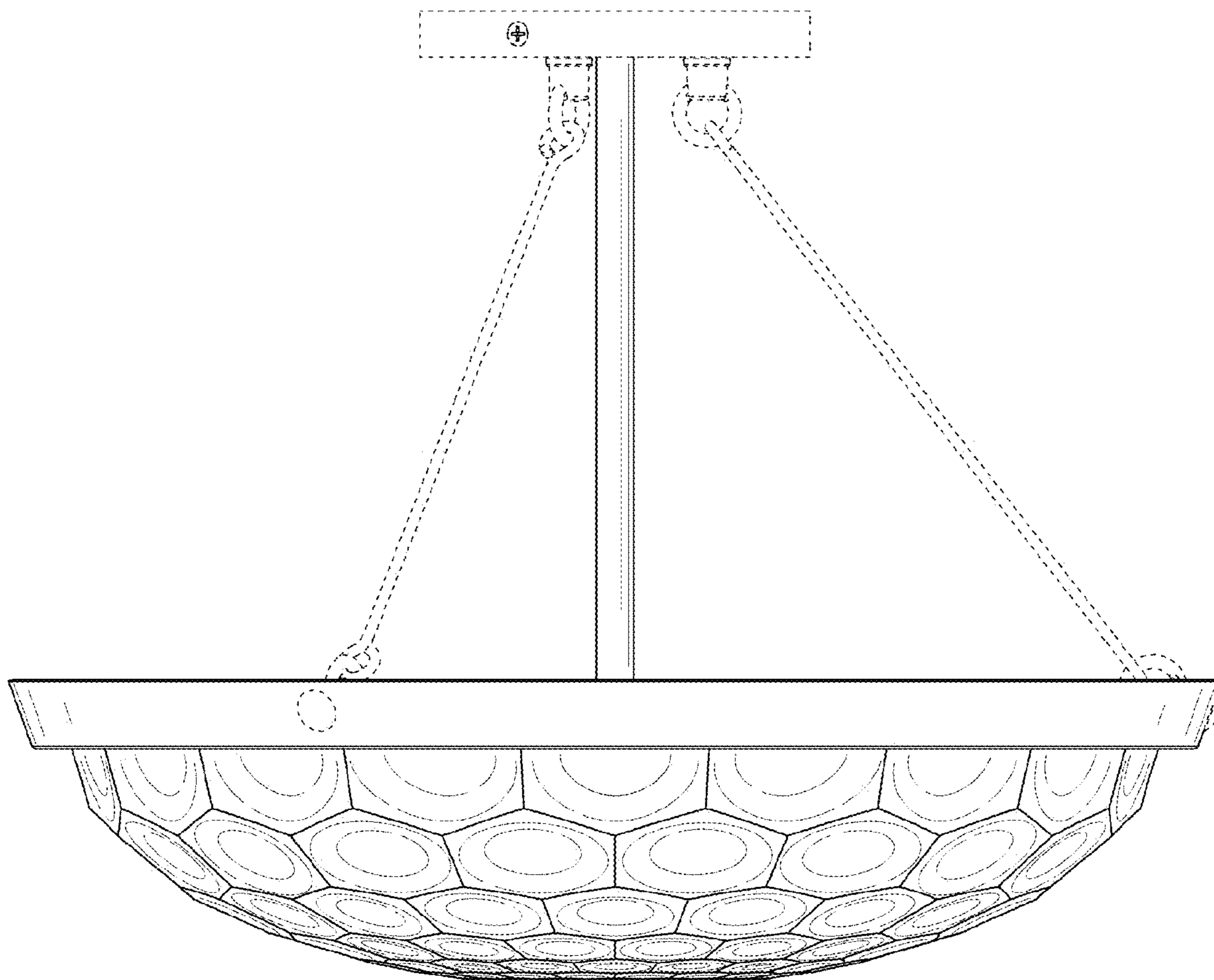


FIG. 12



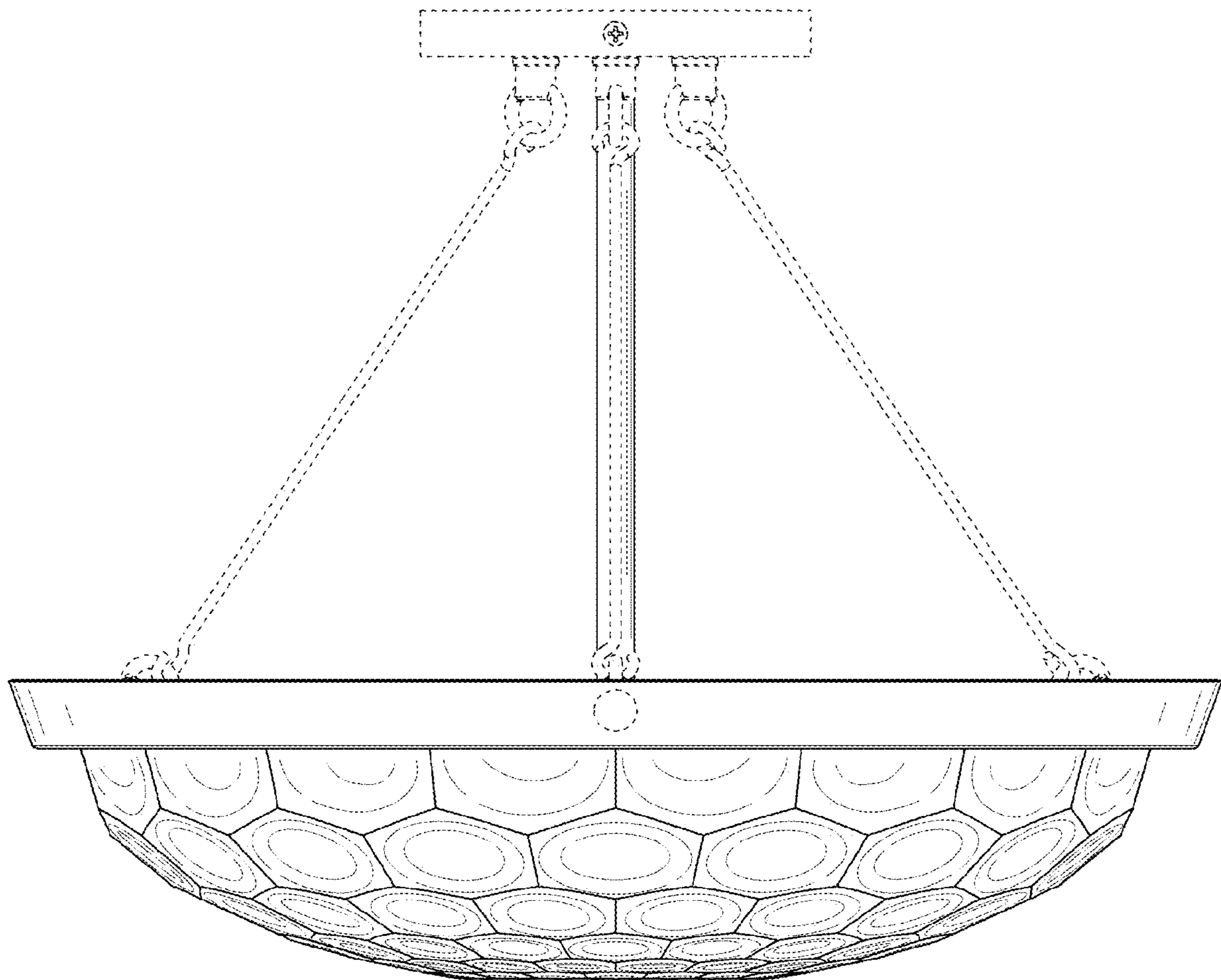


FIG. 13

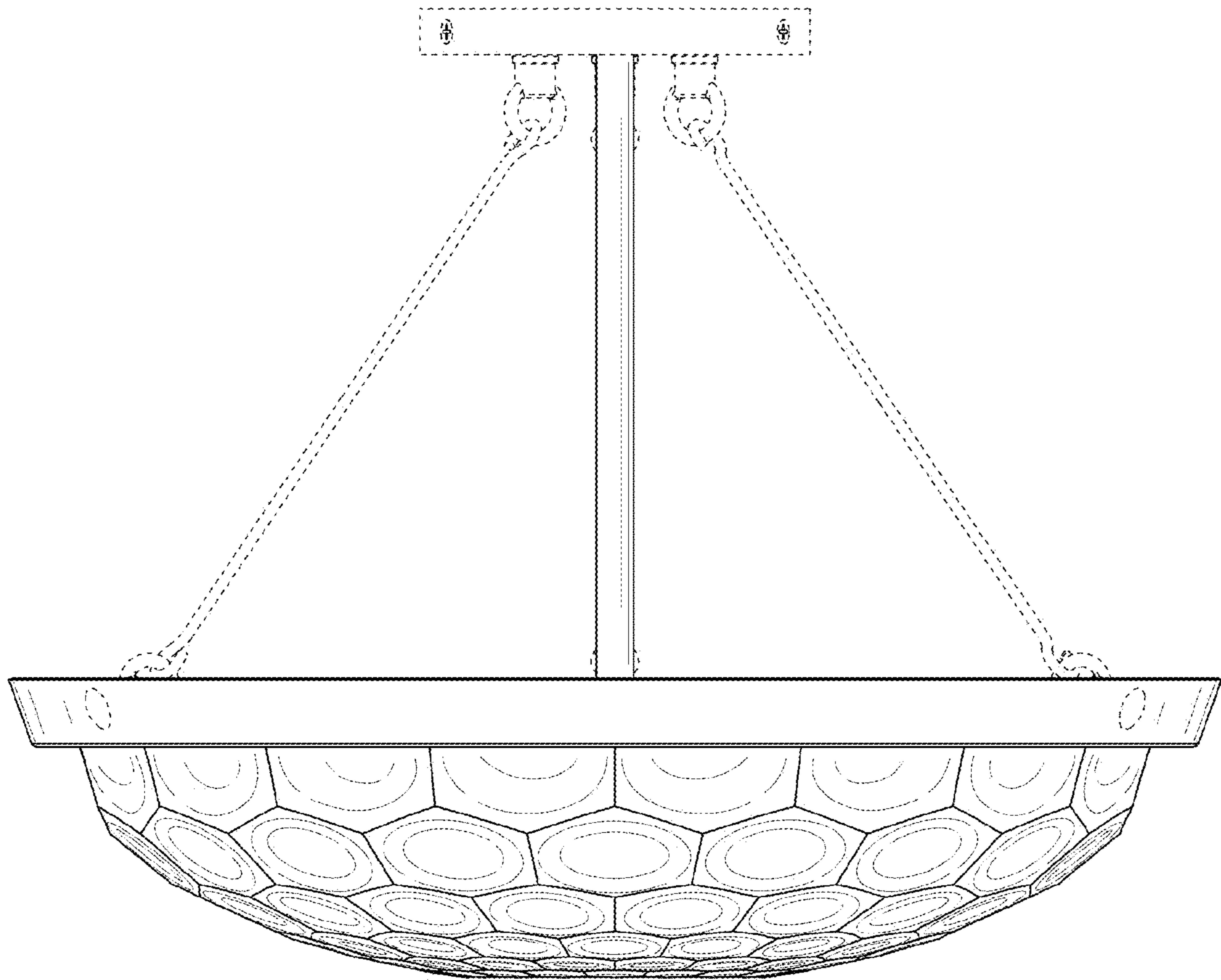


FIG. 14