



US00D961814S

(12) **United States Design Patent** (10) **Patent No.:** **US D961,814 S**
Stocks et al. (45) **Date of Patent:** **** Aug. 23, 2022**

(54) **ARCHITECTURAL PANEL**
(71) Applicant: **Smith & Fong Co.**, Novato, CA (US)
(72) Inventors: **Donald Angus Stocks**, Novato, CA (US); **Robin Reigi**, Staten Island, NY (US)
(73) Assignee: **SMITH & FONG COMPANY**, Novato, CA (US)
(**) Term: **15 Years**
(21) Appl. No.: **29/817,976**
(22) Filed: **Dec. 6, 2021**

Related U.S. Application Data

(62) Division of application No. 29/713,730, filed on Nov. 18, 2019, now Pat. No. Des. 940,910.
(51) **LOC (13) Cl.** **25-01**
(52) **U.S. Cl.**
USPC **D25/138**
(58) **Field of Classification Search**
USPC D25/119–125, 138, 139, 141–144, D25/159–162, 164
CPC E04D 1/02; E04D 1/06; E04D 1/18; E04D 1/24; E04D 1/26; E04D 1/265; E04D 2003/3617; E04D 3/00; E04D 3/02; E04D 3/04; E04D 3/16; E04D 3/361; E04D 3/368; E04F 13/00; E04F 13/007; E04F 13/072; E04F 13/074; E04F 13/075; E04F 13/076; E04F 13/078; E04F 13/08; E04F 13/26

See application file for complete search history.

(56) **References Cited**
U.S. PATENT DOCUMENTS
3,674,620 A * 7/1972 McCarthy et al. B32B 23/06 D25/119
D939,733 S * 12/2021 Stocks D25/138
D939,734 S * 12/2021 Stocks D25/138
D939,735 S * 12/2021 Stocks D25/138
D940,910 S * 1/2022 Stocks D25/138
* cited by examiner

Primary Examiner — Llorellys Martinez
(74) *Attorney, Agent, or Firm* — Steven R. Vosen

(57) **CLAIM**

We claim the ornamental design for an architectural panel, as shown and described.

DESCRIPTION

FIG. 1 is an upper front left perspective view of an architectural panel showing our new design; FIG. 2 is a front elevational view thereof; FIG. 3 is a left side elevational view thereof, the right side elevational view being a mirror image thereof; FIG. 4 is a sectional view taken along line 4-4 in FIG. 5; and, FIG. 5 is a top plan view thereof, the bottom plan view being identical thereto.

The broken lines in the drawings represent portions of the architectural panel that form no part of the claimed design.

1 Claim, 1 Drawing Sheet

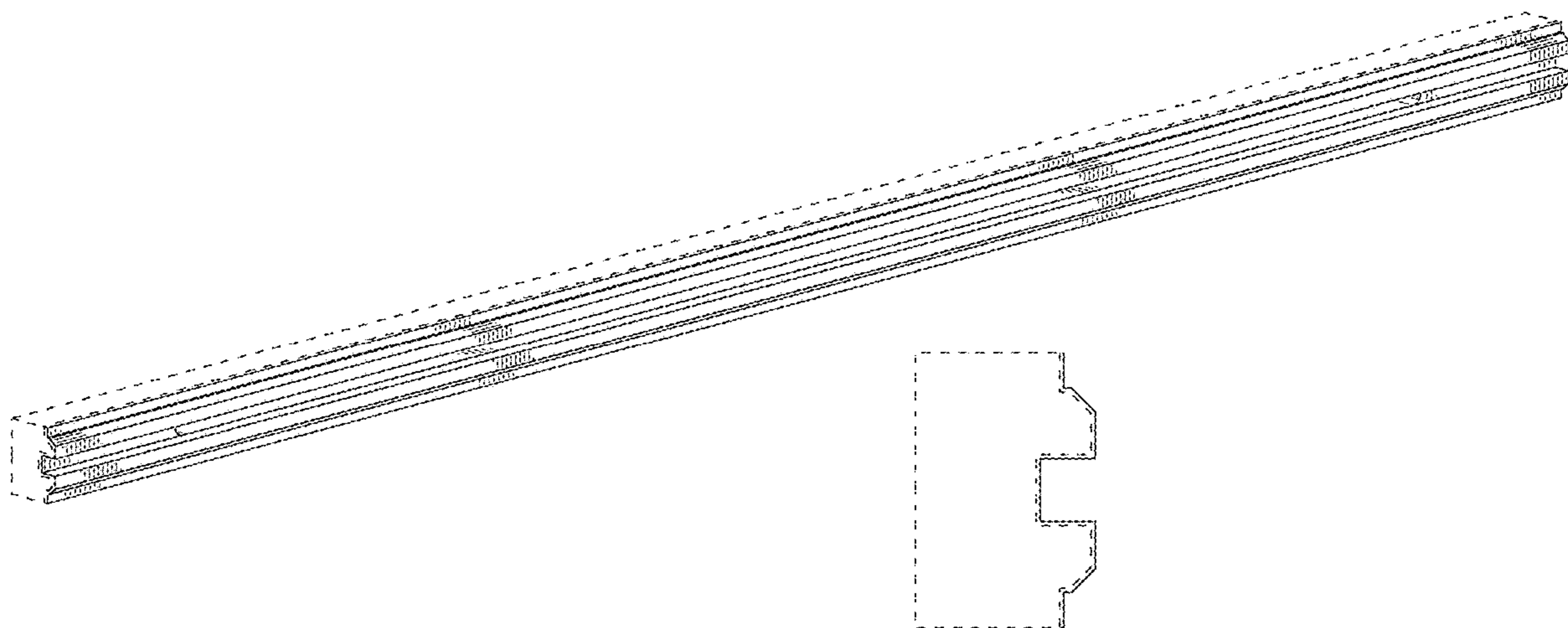

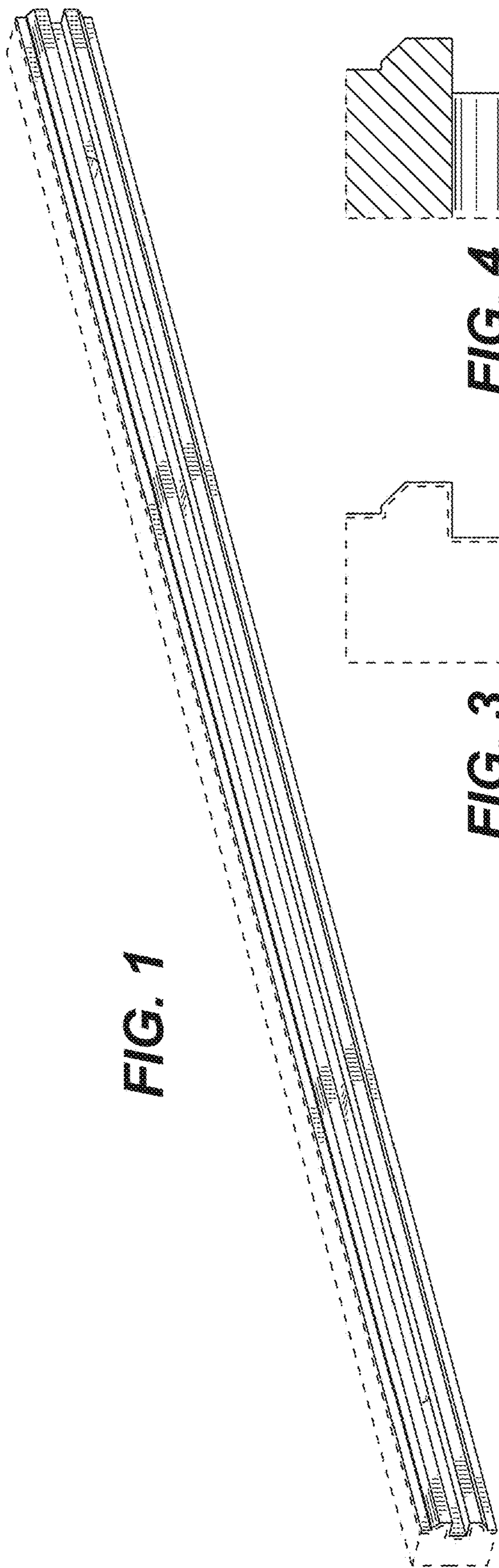

FIG. 1

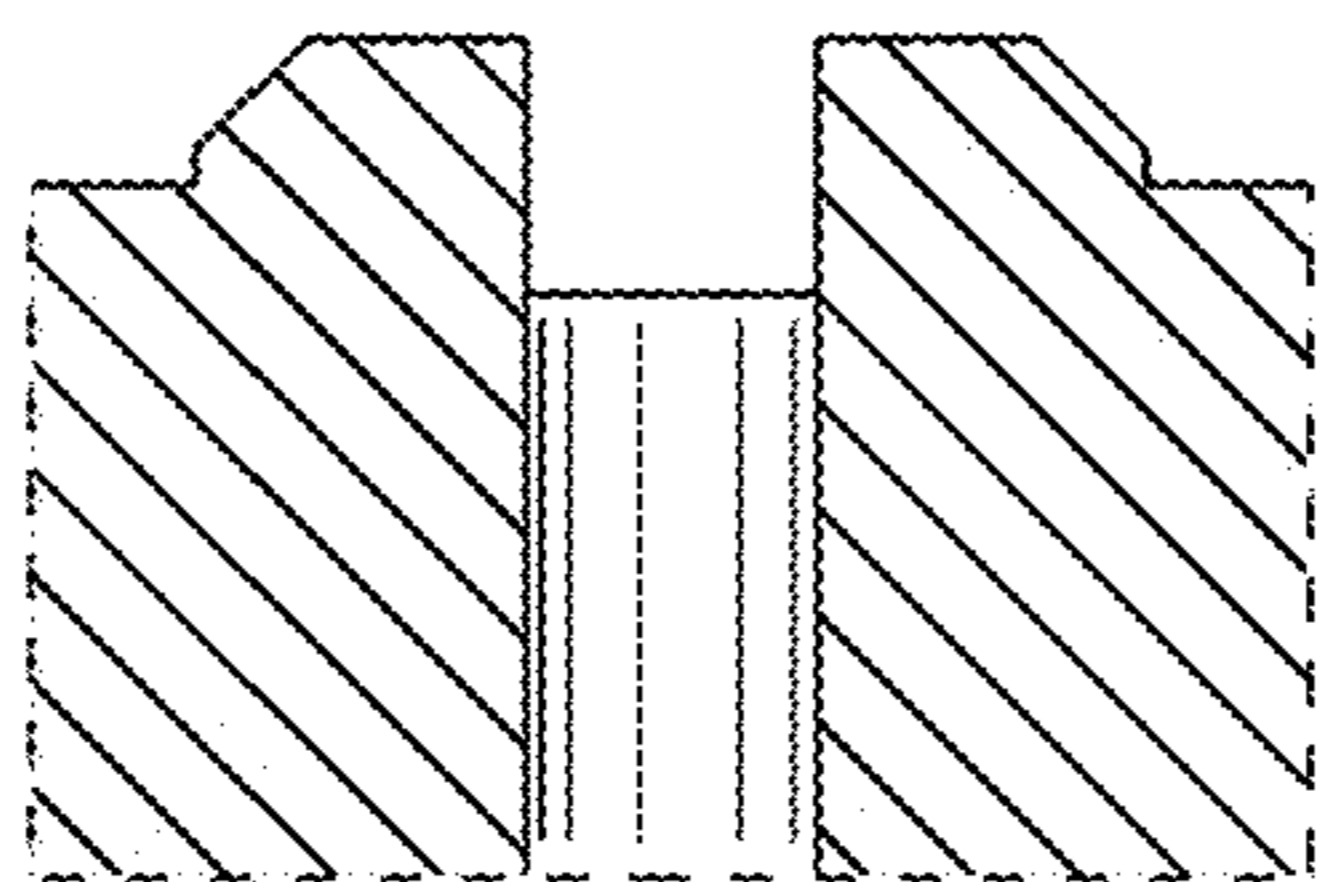

FIG. 4

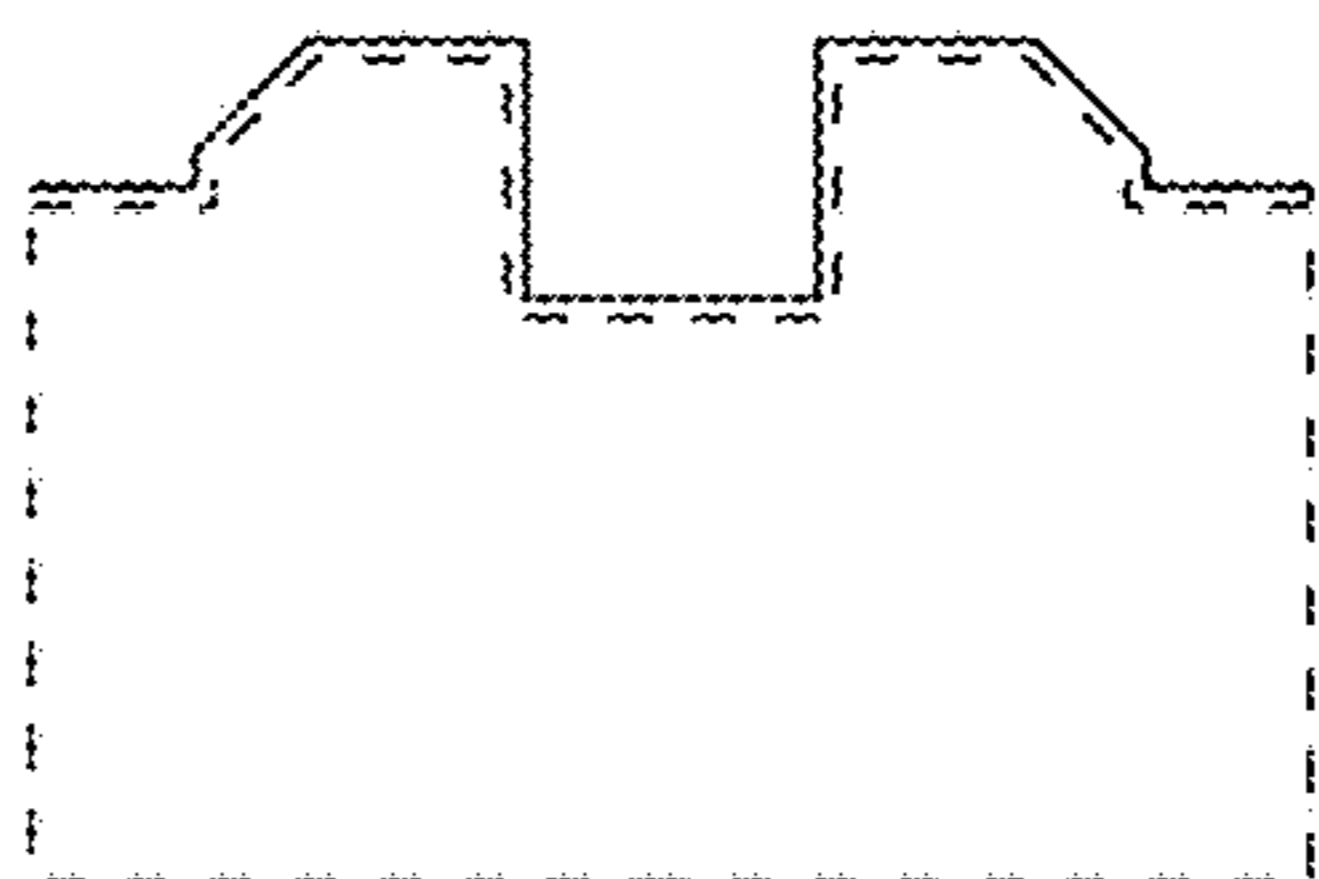

FIG. 3

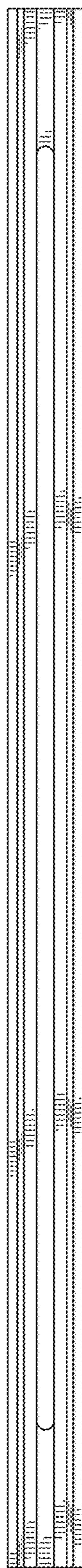

FIG. 2

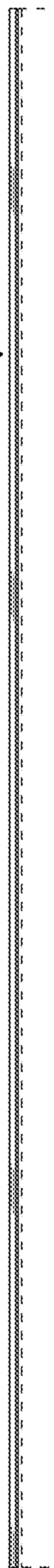
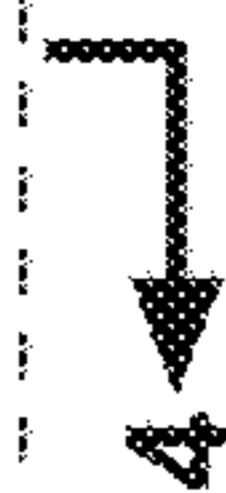
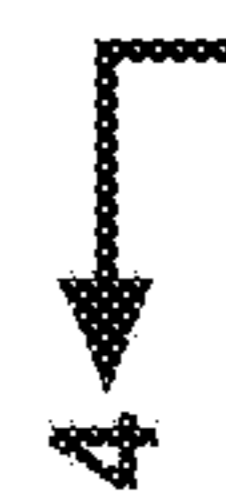

FIG. 5