



US00D961638S

(12) **United States Design Patent**
Lee et al.

(10) **Patent No.:** **US D961,638 S**
(45) **Date of Patent:** **** Aug. 23, 2022**

(54) **REFRIGERATOR**

(71) Applicant: **LG ELECTRONICS INC.**, Seoul (KR)

(72) Inventors: **Jihyun Lee**, Seoul (KR); **Kyukwan Choi**, Seoul (KR); **Hangbok Lee**, Seoul (KR); **Minsub Kim**, Seoul (KR); **Yong Kim**, Seoul (KR)

(73) Assignee: **LG ELECTRONICS INC.**, Seoul (KR)

(**) Term: **15 Years**

(21) Appl. No.: **29/800,419**

(22) Filed: **Jul. 21, 2021**

(30) **Foreign Application Priority Data**

Jan. 22, 2021 (KR) 30-2021-0003626

(51) **LOC (13) Cl.** **15-07**

(52) **U.S. Cl.**
USPC **D15/86**; D15/81; D15/91

(58) **Field of Classification Search**
USPC D15/79-91
CPC F25D 2323/021; F25D 2323/024; F25D 29/00; F25D 27/005; F25D 29/005; F25D 17/042; F25D 2325/021; F25D 11/00; F25D 11/02; F25D 11/025; F25D 23/00; F25D 23/02; F25D 23/04; F25D 23/12; F25D 23/028; F25D 25/02; F25D 25/021; F25D 25/022; F25D 25/024; F25D 25/025; A47F 3/04; A47F 3/0404
See application file for complete search history.

(56) **References Cited**

U.S. PATENT DOCUMENTS

D603,429 S * 11/2009 Lee D15/85
D657,805 S * 4/2012 Cho D15/86
D658,215 S * 4/2012 Seo D15/86

D715,335 S * 10/2014 Kim D15/85
D729,285 S * 5/2015 Seo D15/85
D740,335 S * 10/2015 Hwang D15/89
D741,380 S * 10/2015 Ogg D15/86
D786,317 S * 5/2017 Kim D15/85
D798,915 S * 10/2017 Vicari D15/86
D807,410 S * 1/2018 Cho D15/86
D814,533 S * 4/2018 Kim D15/85

(Continued)

OTHER PUBLICATIONS

LG Electronics, LRFDS3016S 36 Inch Smart French Door Craft Ice Refrigerator, (site visited Dec. 16, 2021), AJ Madison website, URL:<<https://www.ajmadison.com/cgi-bin/ajmadison/LRFDS3016.html>> (Year: 2021).*

(Continued)

Primary Examiner — Calvin E Vansant

Assistant Examiner — Mark T. Philipps

(74) *Attorney, Agent, or Firm* — Birch, Stewart, Kolasch & Birch, LLP

(57) **CLAIM**

The ornamental design for a refrigerator, as shown and described.

DESCRIPTION

FIG. 1 is a front perspective view of the refrigerator showing our new design;
FIG. 2 is a front view thereof;
FIG. 3 is a back view thereof;
FIG. 4 is a left side view thereof;
FIG. 5 is a right side view thereof;
FIG. 6 is a top plan view thereof;
FIG. 7 is a bottom plan view thereof; and,
FIG. 8 is a perspective view showing the design in a state of use.
The broken lines depict portions of the refrigerator that form no part of the claimed design.

1 Claim, 8 Drawing Sheets

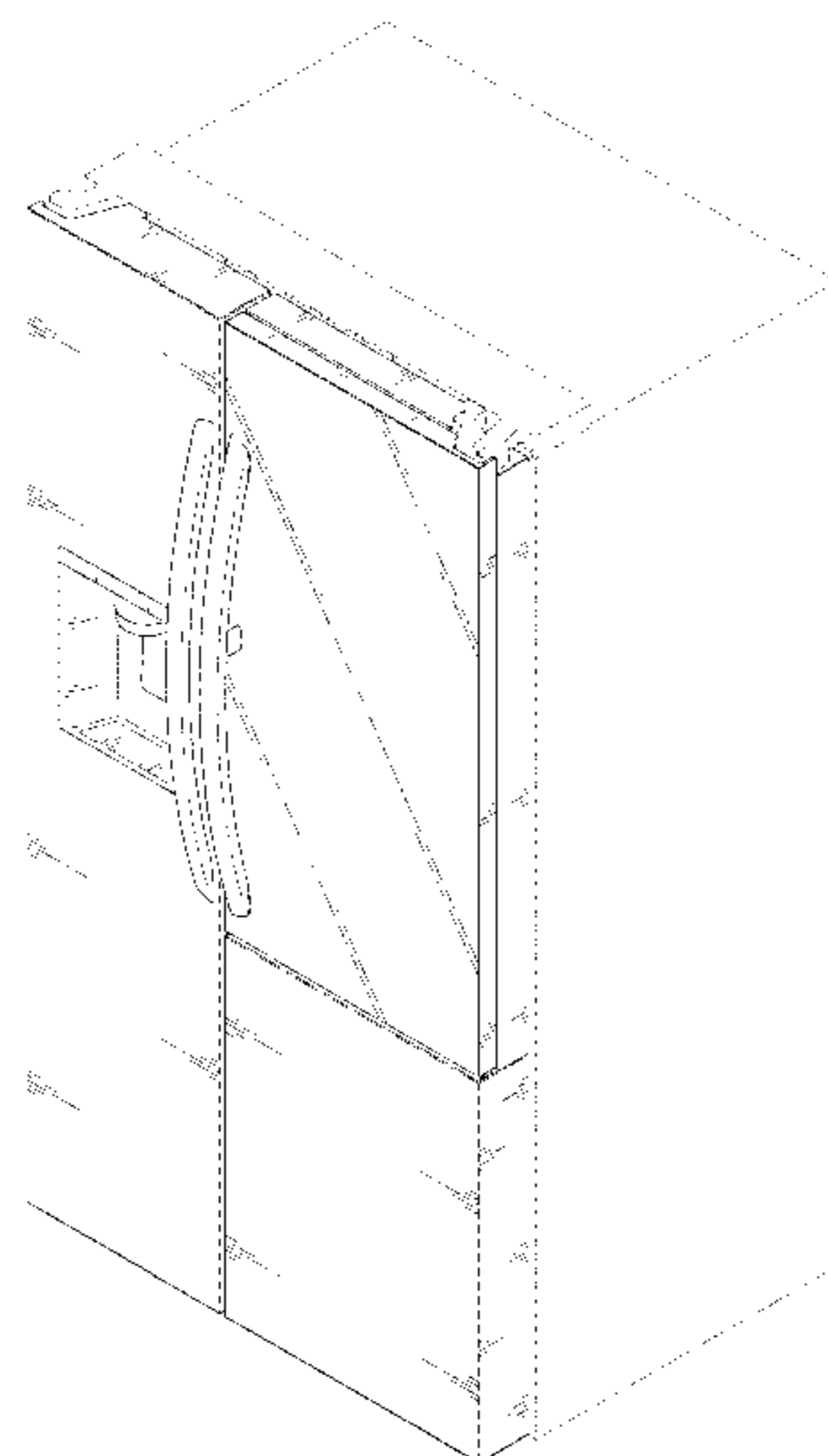

(56)

References Cited

U.S. PATENT DOCUMENTS

D832,312	S	*	10/2018	Kim	D15/86
D838,297	S	*	1/2019	Choi	D15/81
D847,875	S	*	5/2019	Kim	D15/85
D869,518	S	*	12/2019	Lee	D15/85
D888,110	S	*	6/2020	Lee	D15/85
D905,767	S	*	12/2020	Lee	D15/89
D921,064	S	*	6/2021	Lee	D15/89
D921,065	S	*	6/2021	Lee	D15/89
D921,711	S	*	6/2021	Lee	D15/85
D921,714	S	*	6/2021	Yoon	D15/86
D933,110	S	*	10/2021	Lee	D15/86
2015/0069900	A1	*	3/2015	Lim	F25D 23/025 312/405
2015/0225225	A1	*	8/2015	Tae	B67D 1/0858 222/146.2

OTHER PUBLICATIONS

Samsung, RF23A9671SR 36 Inch Counter Depth 4-Door Flex™ Smart Refrigerator, (site visited Dec. 16, 2021), AJ Madison website, URL:<<https://www.ajmadison.com/cgi-bin/ajmadison/RF23A9671.html>> (Year: 2021).*

Cafe, CQE28DM5NS5 36 Inch 4-Door French Door Smart Refrigerator, (site visited Dec. 16, 2021), AJ Madison website, URL:<<https://www.ajmadison.com/cgi-bin/ajmadison/CQE28DM5NS5.html>> (Year: 2021).*

Dacor, DRF36C700SR 36 Inch Smart French Door Refrigerator, (site visited Dec. 16, 2021), AJ Madison website, URL:<<https://www.ajmadison.com/cgi-bin/ajmadison/DRF36C700X.html>> (Year: 2021).*

* cited by examiner

FIG. 1

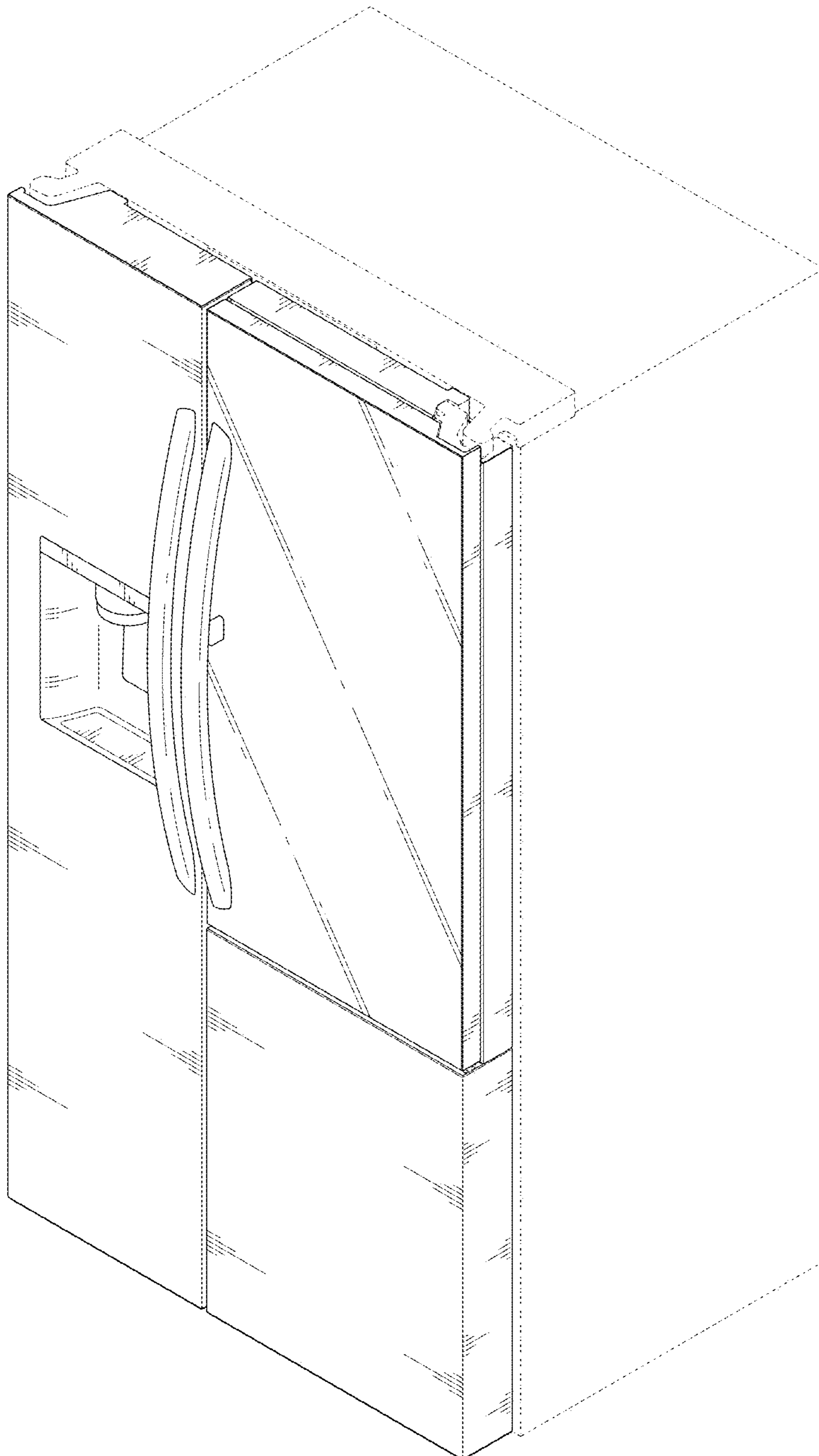

FIG. 2

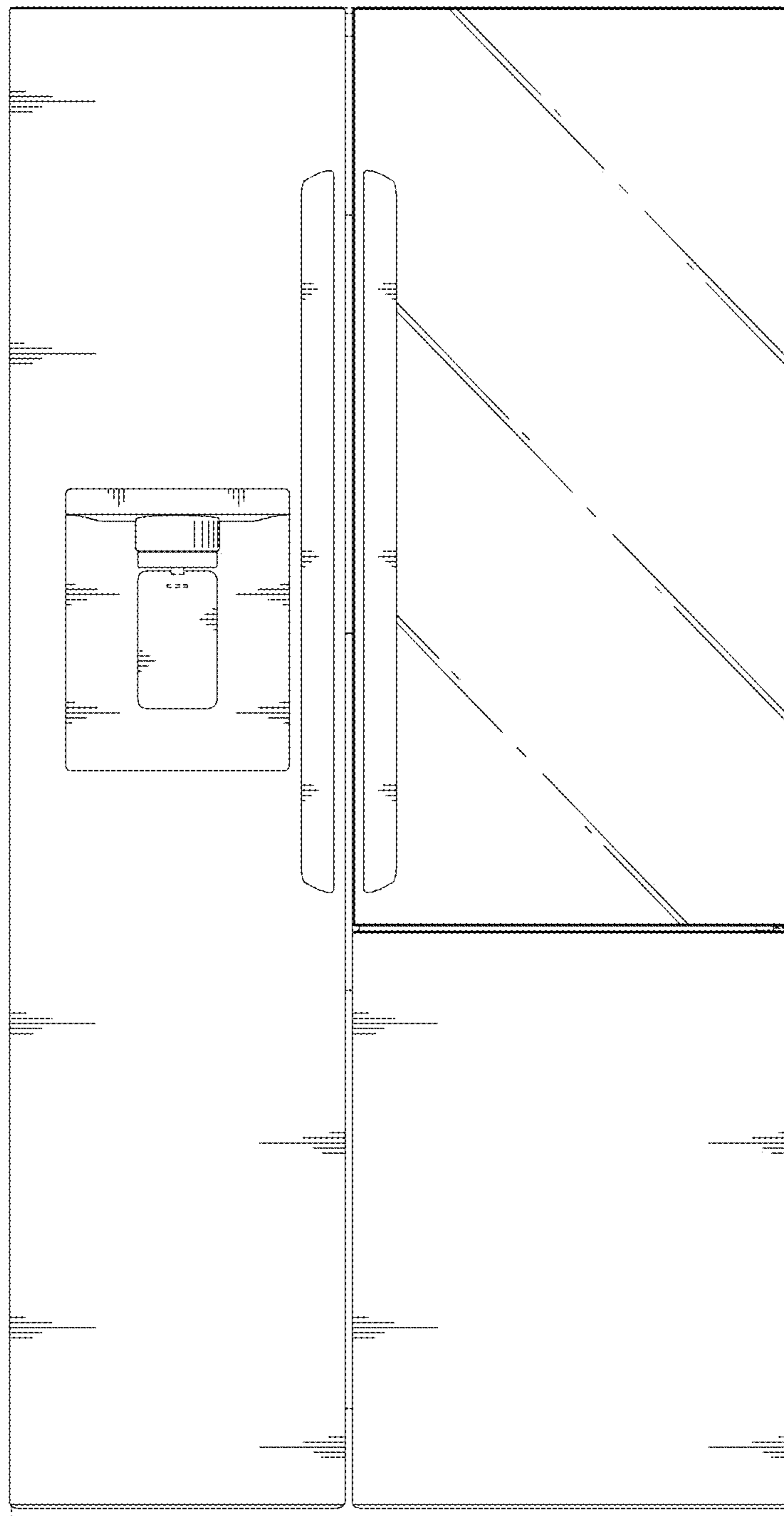

FIG. 3

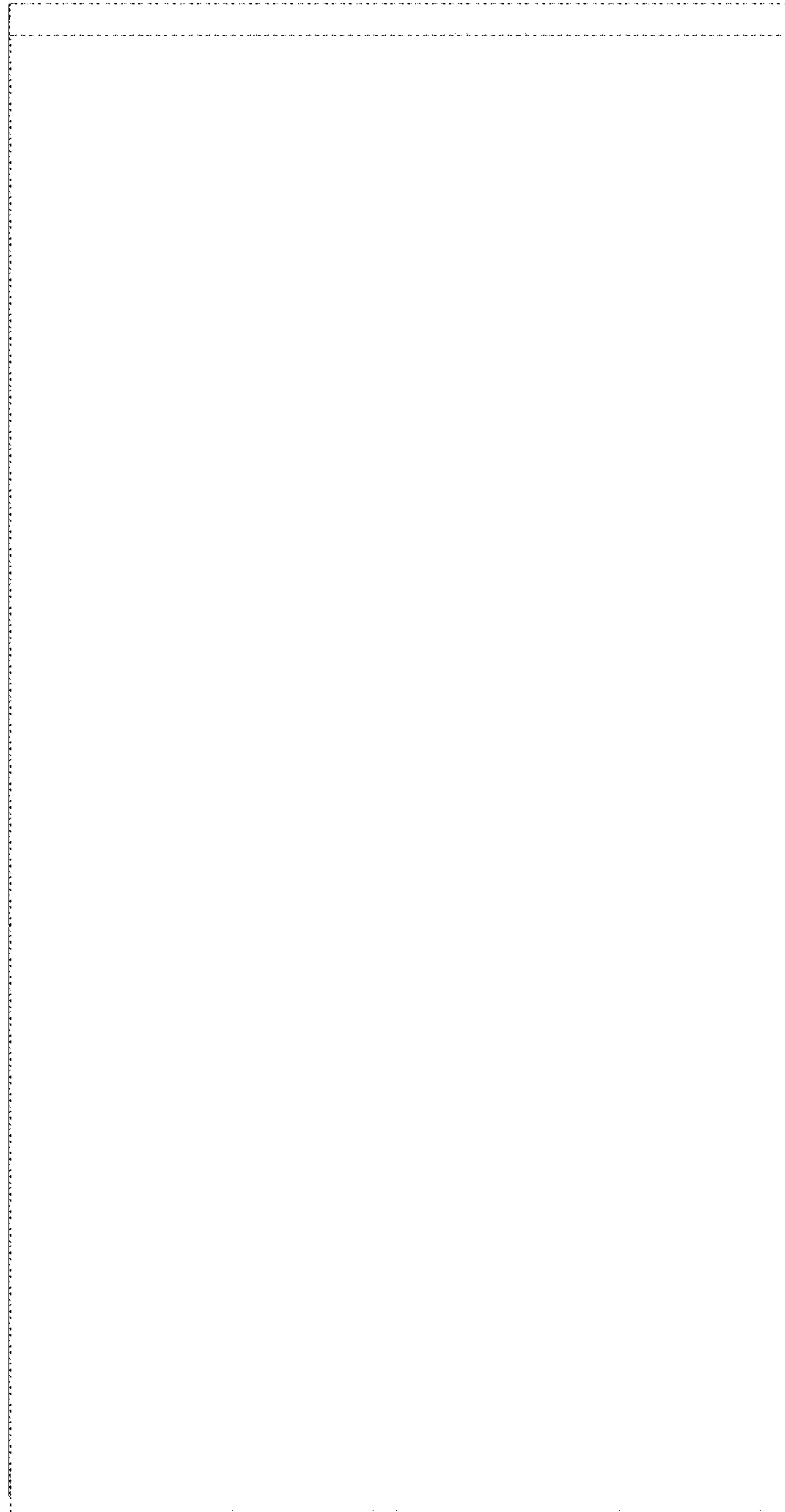

FIG. 4

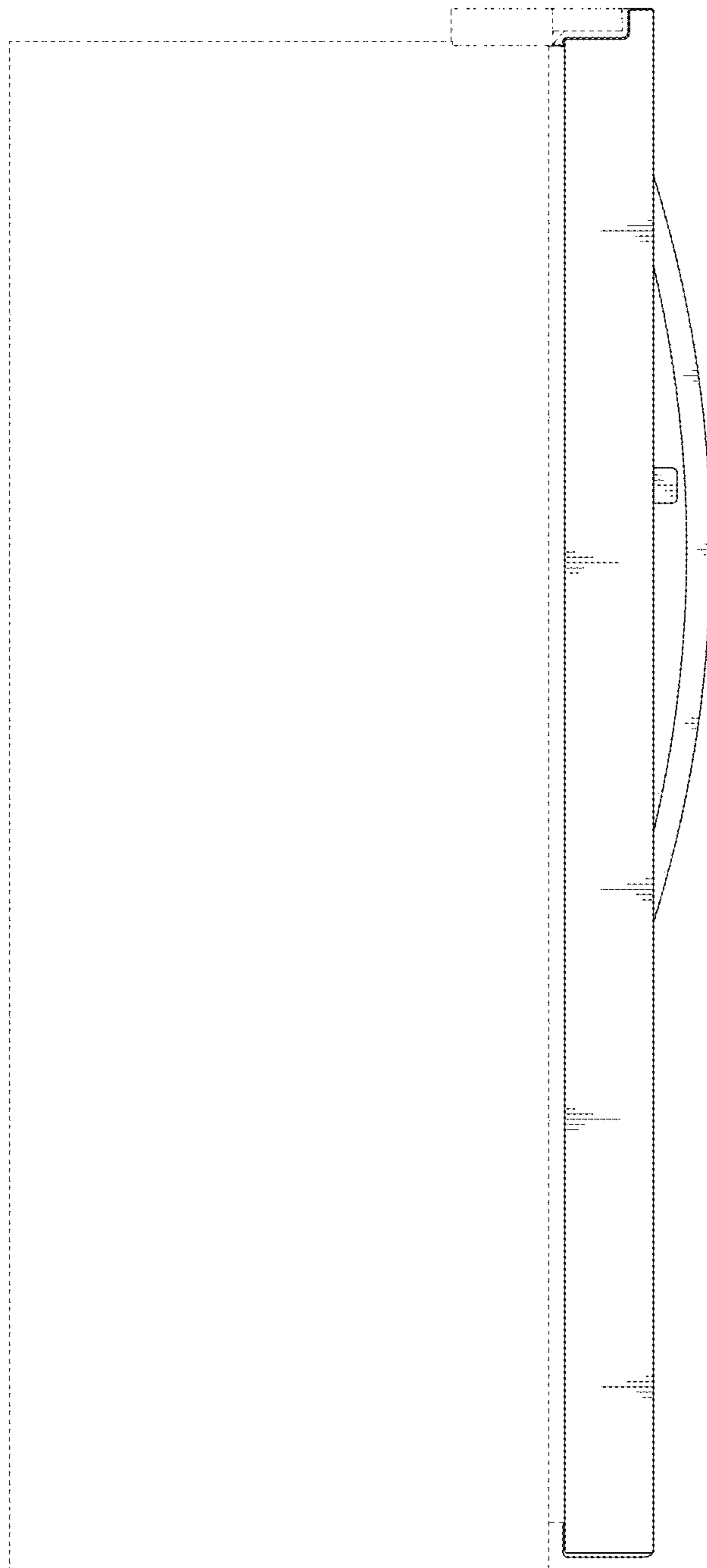

FIG. 5

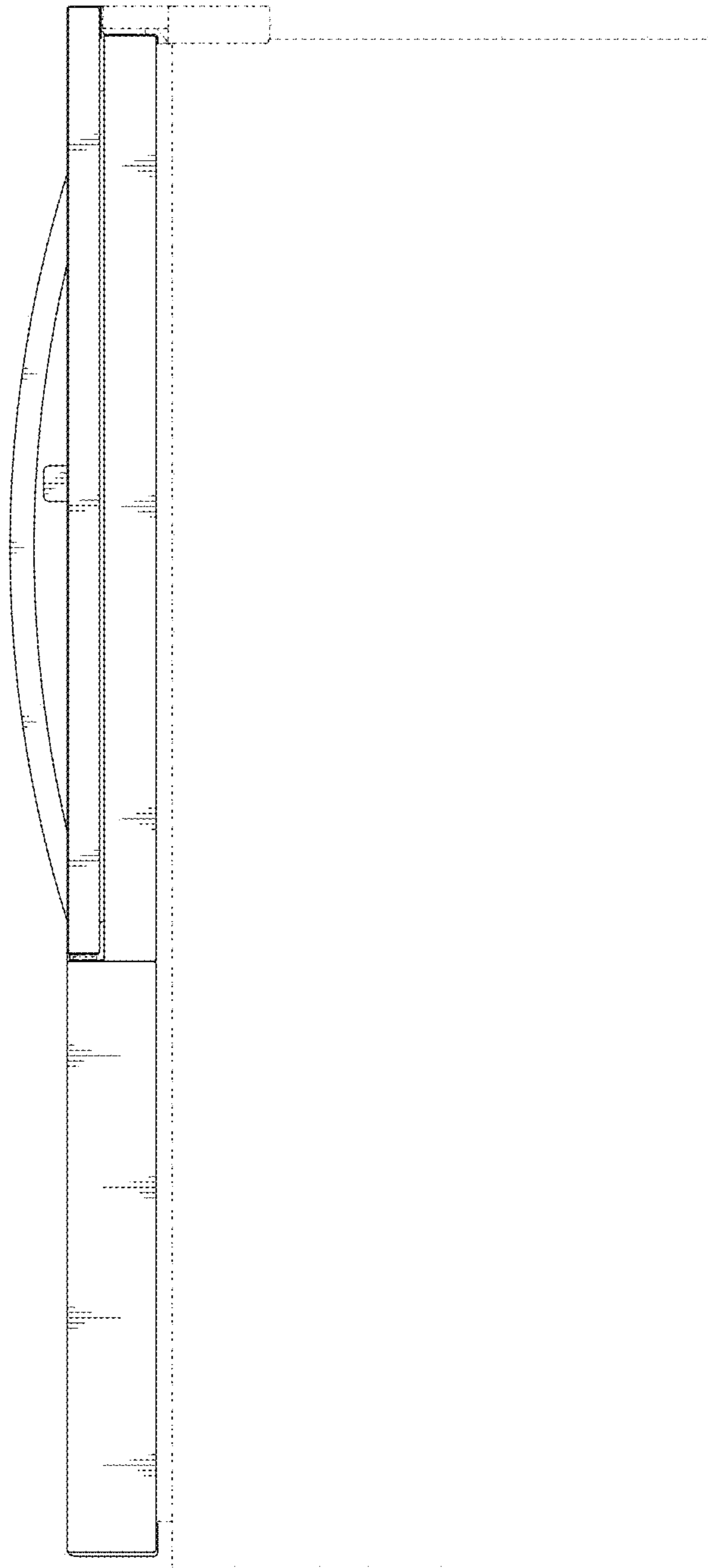

FIG. 6

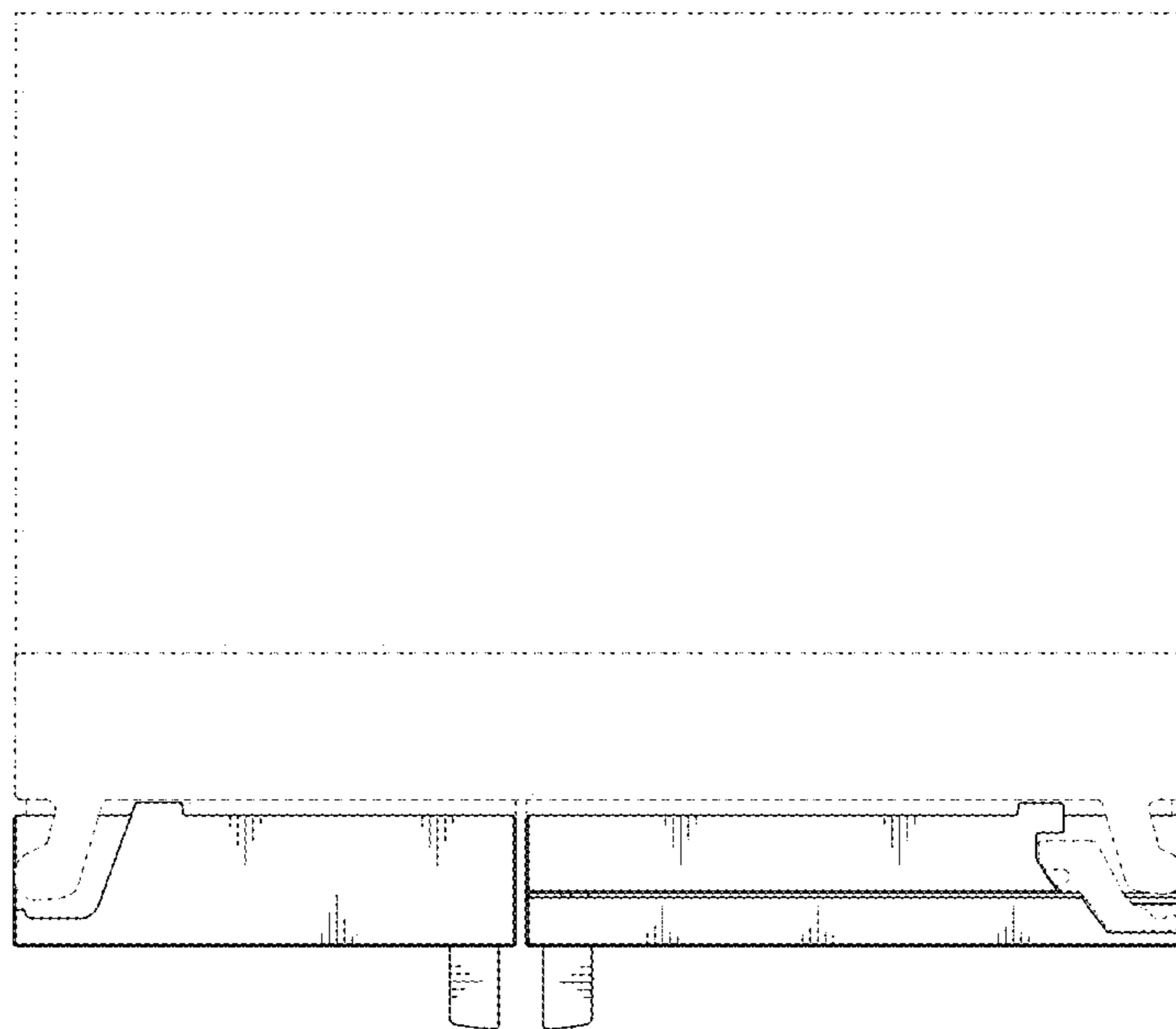

FIG. 7

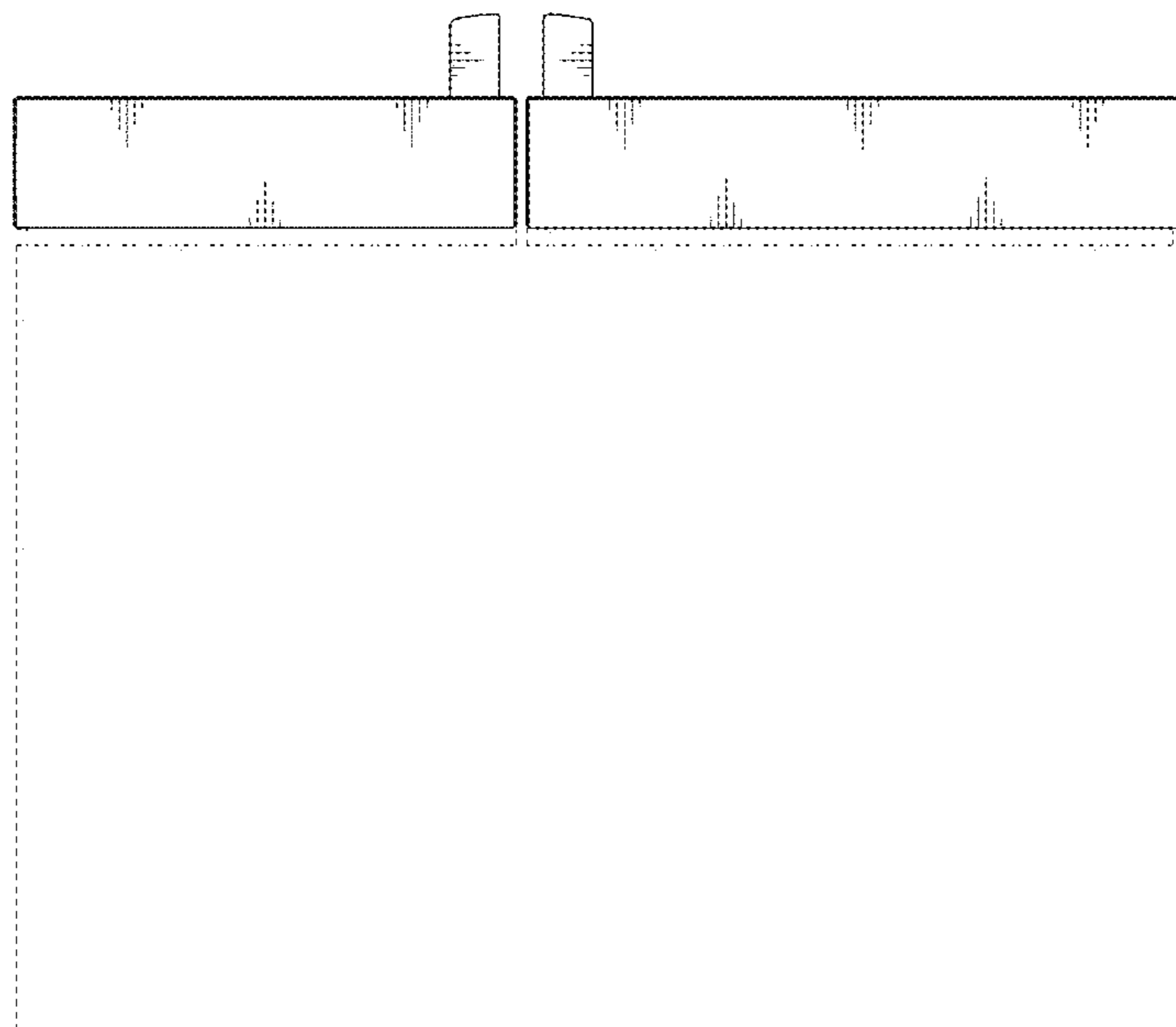

FIG. 8

