



US00D961633S

(12) **United States Design Patent** (10) **Patent No.:** **US D961,633 S**  
**Choi et al.** (45) **Date of Patent:** **\*\* Aug. 23, 2022**

(54) **REFRIGERATOR**

(71) Applicant: **LG ELECTRONICS INC.**, Seoul (KR)

(72) Inventors: **Wonsang Choi**, Seoul (KR); **Kyukwan Choi**, Seoul (KR); **Sanghun Kim**, Seoul (KR); **Seungjin Yoon**, Seoul (KR)

(73) Assignee: **LG ELECTRONICS INC.**, Seoul (KR)

(\*\*) Term: **15 Years**

(21) Appl. No.: **29/751,768**

(22) Filed: **Sep. 23, 2020**

(30) **Foreign Application Priority Data**

Apr. 10, 2020 (KR) ..... 30-2020-0016118

(51) **LOC (13) Cl.** ..... **15-07**

(52) **U.S. Cl.**  
USPC ..... **D15/81**; D15/79; D15/91

(58) **Field of Classification Search**  
USPC ..... D15/79-91; D6/661

(Continued)

(56) **References Cited**

**U.S. PATENT DOCUMENTS**

D597,562 S \* 8/2009 Yang ..... D15/81  
D642,600 S \* 8/2011 Kristiansen ..... D15/86

(Continued)

**OTHER PUBLICATIONS**

LG Electronics, LG Dios Knock-On Magic Space Object Collection M872MGG451S, (site visited Dec. 8, 2021) LGE Korean Website, URL:<<https://www.lge.co.kr/refrigerators/m872mgg451s>> (Year: 2021).\*

(Continued)

*Primary Examiner* — Calvin E Vansant

*Assistant Examiner* — Mark T. Philipps

(74) *Attorney, Agent, or Firm* — Birch, Stewart, Kolasch & Birch, LLP

(57) **CLAIM**

The ornamental design for a refrigerator, as shown and described.

**DESCRIPTION**

FIG. 1 is a front perspective view of the refrigerator showing our new design;

FIG. 2 is a front view thereof;

FIG. 3 is a back view thereof;

FIG. 4 is a left side view thereof;

FIG. 5 is a right side view thereof;

FIG. 6 is a top plan view thereof;

FIG. 7 is a bottom plan view thereof;

FIG. 8 is a perspective view showing the design in a state of use;

FIG. 9 is a perspective view showing the design in another state of use;

FIG. 10 is a front view of FIG. 9;

FIG. 11 is a back view of FIG. 9;

FIG. 12 is a left side view of FIG. 9;

FIG. 13 is a right side view of FIG. 9;

FIG. 14 is a top plan view of FIG. 9;

FIG. 15 is a bottom plan view of FIG. 9;

FIG. 16 is a perspective view showing the design in yet another state of use;

FIG. 17 is a front view of FIG. 16;

FIG. 18 is a back view of FIG. 16;

FIG. 19 is a left side view of FIG. 16;

FIG. 20 is a right side view of FIG. 16;

FIG. 21 is a top plan view of FIG. 16; and,

FIG. 22 is a bottom plan view of FIG. 16.

The broken lines depict portions of the refrigerator that form no part of the claimed design. The dash-dot broken lines define the bounds of the claimed design and form no part thereof.

**1 Claim, 22 Drawing Sheets**

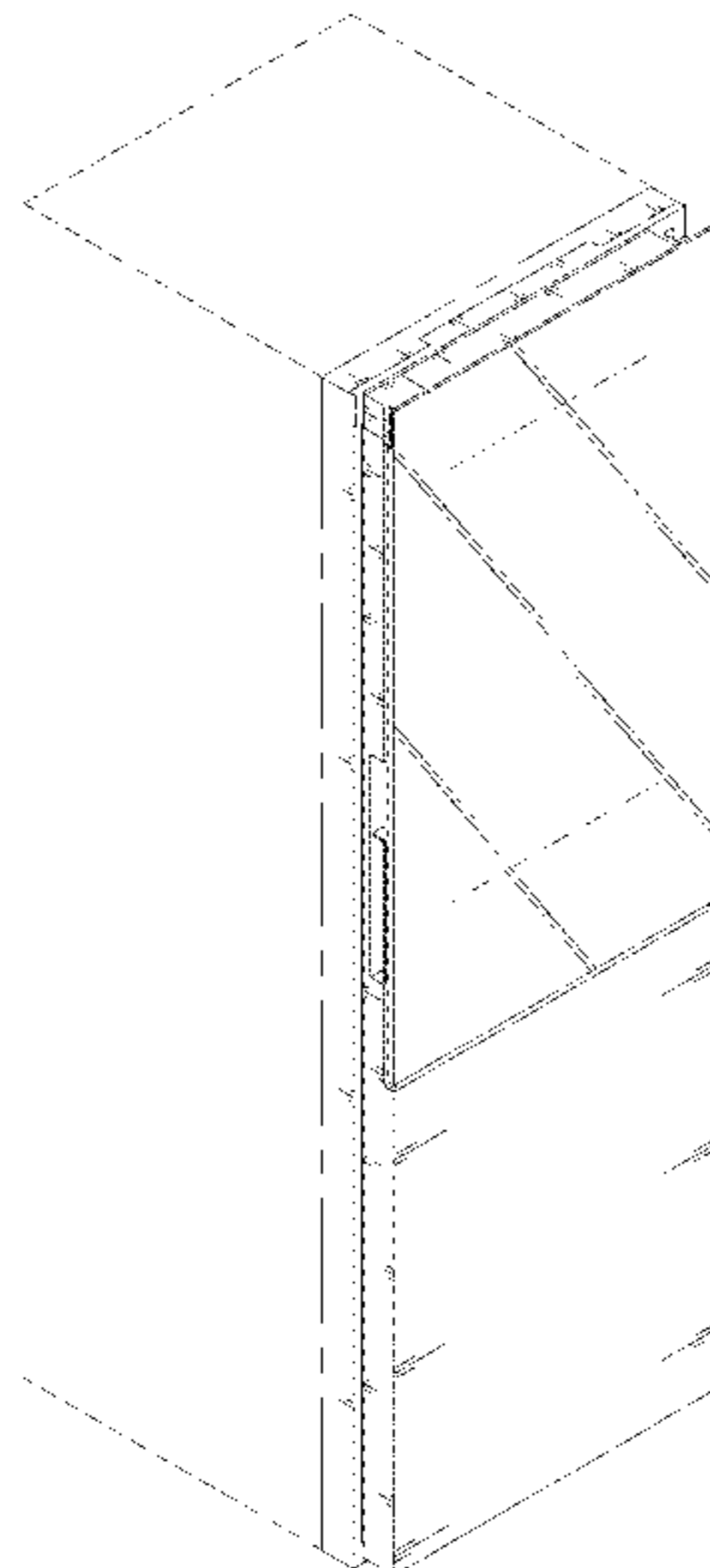

- (58) **Field of Classification Search**  
 CPC ..... F25D 2323/021; F25D 2323/024; F25D  
 29/00; F25D 27/005; F25D 29/005; F25D  
 17/042; F25D 2325/021; F25D 11/00;  
 F25D 11/02; F25D 11/025; F25D 23/00;  
 F25D 23/02; F25D 23/04; F25D 23/12;  
 F25D 23/028; F25D 25/02; F25D 25/021;  
 F25D 25/022; F25D 25/024; F25D  
 25/025; A47F 3/04; A47F 3/0404  
 See application file for complete search history.

(56) **References Cited**

U.S. PATENT DOCUMENTS

D665,828	S	*	8/2012	Hong	.....	D15/91
D701,539	S	*	3/2014	Saejin	.....	D15/85
D760,822	S	*	7/2016	Lee	.....	D15/91
D760,823	S	*	7/2016	Lee	.....	D15/91
D761,334	S	*	7/2016	Lee	.....	D15/86
D761,336	S	*	7/2016	Lee	.....	D15/91
D768,738	S	*	10/2016	Lee	.....	D15/91
D768,739	S	*	10/2016	Lee	.....	D15/91
D771,724	S	*	11/2016	Jeon	.....	D15/86
D773,539	S	*	12/2016	Kim	.....	D15/86
D780,815	S	*	3/2017	Seo	.....	D15/91
D786,948	S	*	5/2017	Lee	.....	D15/86
D791,199	S	*	7/2017	Kim	.....	D15/86
D803,278	S	*	11/2017	Kim	.....	D15/89
D807,408	S	*	1/2018	Kim	.....	D15/81
D807,409	S	*	1/2018	Onrat	.....	D15/85
D825,619	S	*	8/2018	Lee	.....	D15/81
D825,620	S	*	8/2018	Lee	.....	D15/81
D827,683	S	*	9/2018	Jeon	.....	D15/85
D841,058	S	*	2/2019	Lee	.....	D15/86
D841,060	S	*	2/2019	Jeon	.....	D15/91

D847,214	S	*	4/2019	Guo	.....	D15/81
D855,085	S	*	7/2019	Jeon	.....	D15/85
10,342,363	B2	*	7/2019	Park	.....	F21V 23/002
D876,493	S	*	2/2020	Fidler	.....	D15/86
D892,873	S	*	8/2020	Park	.....	D15/85
D895,695	S	*	9/2020	Choi	.....	D15/85
D908,748	S	*	1/2021	Lee	.....	D15/91
D916,145	S	*	4/2021	Kim	.....	F25D 25/025 D15/85
D921,064	S	*	6/2021	Lee	.....	D15/89
D921,714	S	*	6/2021	Yoon	.....	D15/86
D923,064	S	*	6/2021	Incukur	.....	D15/81
D923,065	S	*	6/2021	Lee	.....	D15/89
D926,829	S	*	8/2021	Kim	.....	F25D 25/025 D15/85
D927,563	S	*	8/2021	Lee	.....	D15/88
D929,472	S	*	8/2021	Kim	.....	F25D 25/025 D15/81

OTHER PUBLICATIONS

LG Electronics, LG Signature 31 cu. ft. Smart wi-fi Enabled InstaView Door-in-Door Refrigerator, (site visited Dec. 8, 2021)  
 LGE US Website, URL:<<https://www.lg.com/us/refrigerators/lg-urnts3106n-instaview-door-in-door-refrigerator-lgsignature>> (Year: 2021).\*

LG Electronics, 36 Inch Smart Freestanding Side by Side Refrigerator LRSOS2706S, (site visited Dec. 9, 2021), Appliance Connection Website, URL:<<https://www.appliancesconnection.com/lg-lrsos2706s.html>> (Year: 2021).\*

Dacor, 24" Contemporary Column Refrigerator 1216914, (site visited Dec. 9, 2021), Appliance Connection Website, URL:<<https://www.appliancesconnection.com/dacor-1216914.html>> (Year: 2021).\*

\* cited by examiner

FIG. 1

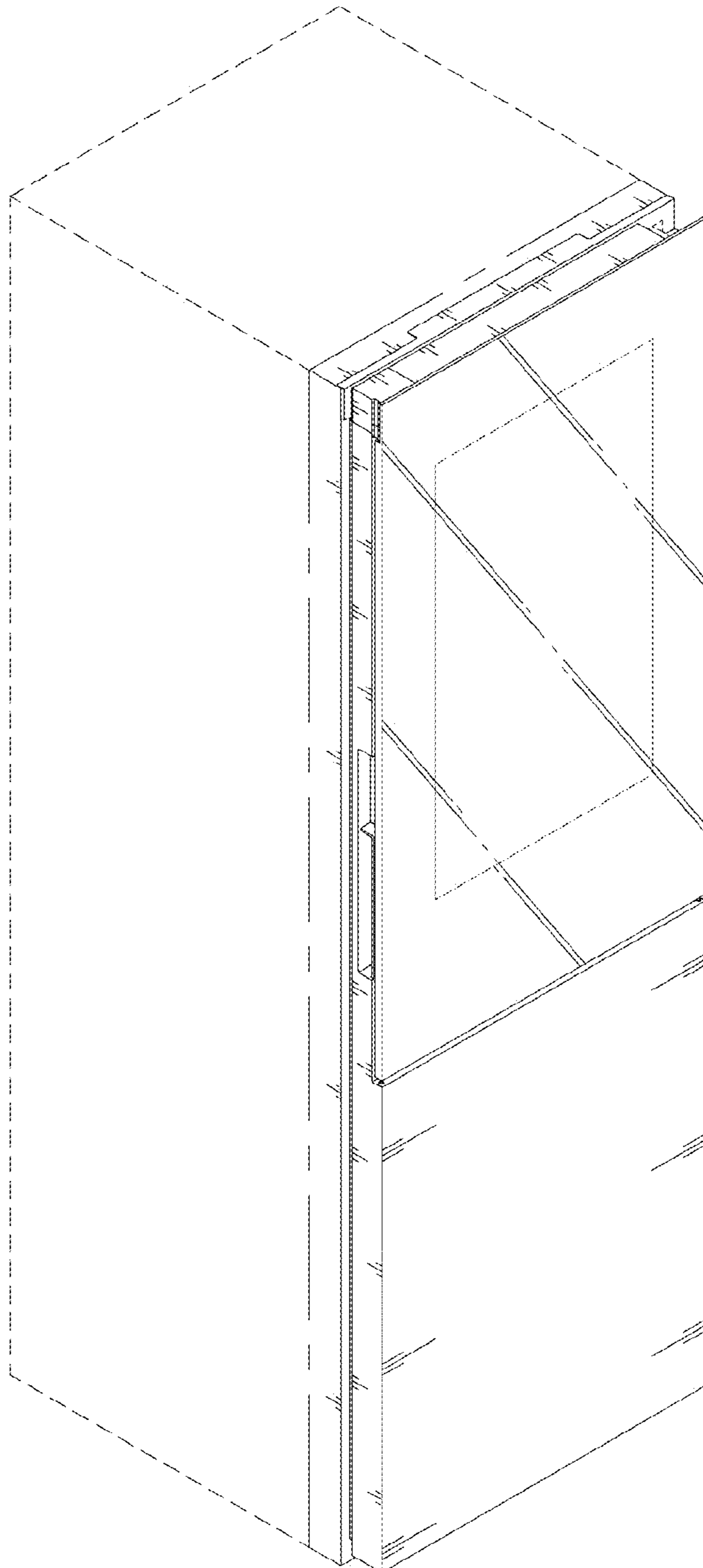

FIG. 2

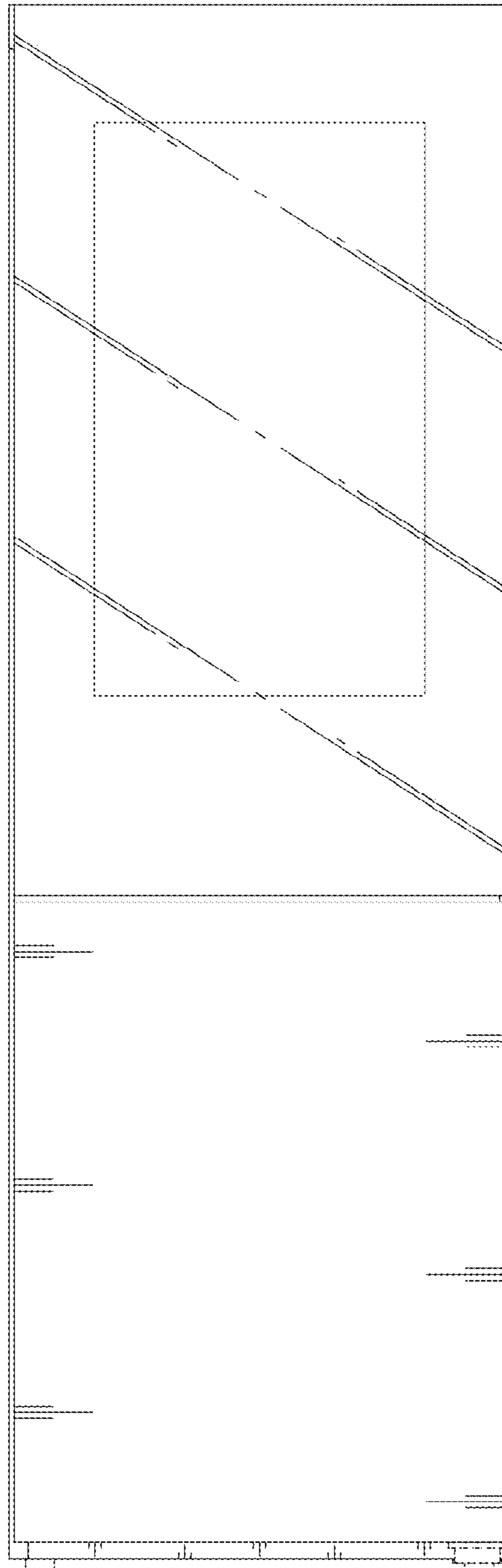

FIG. 3

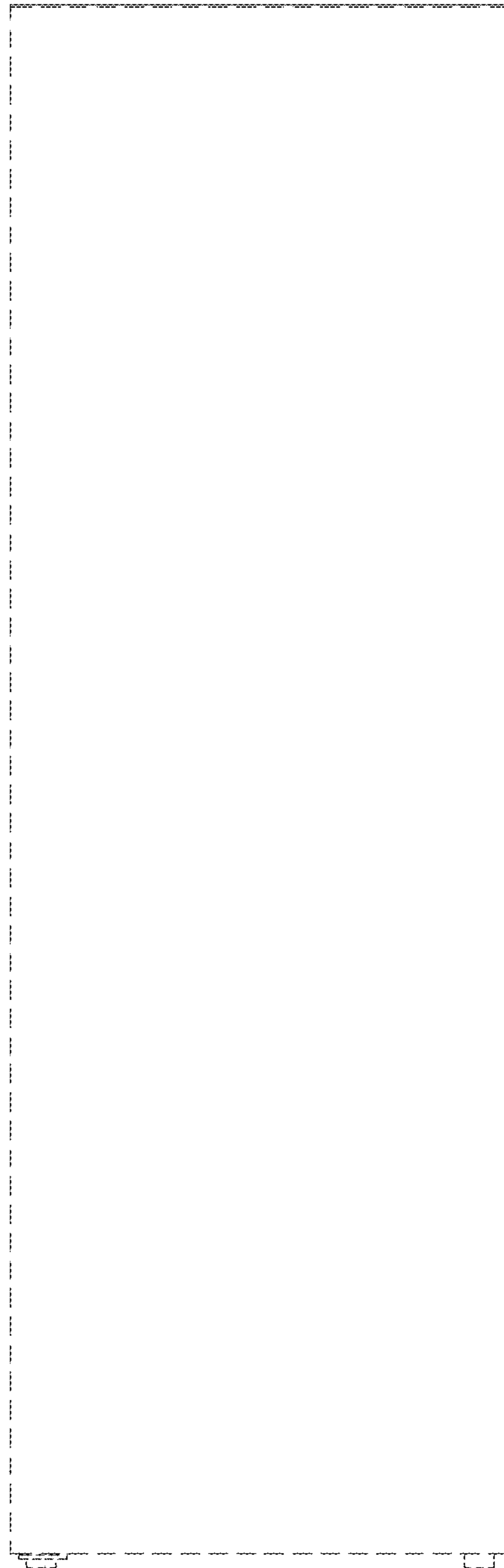

FIG. 4

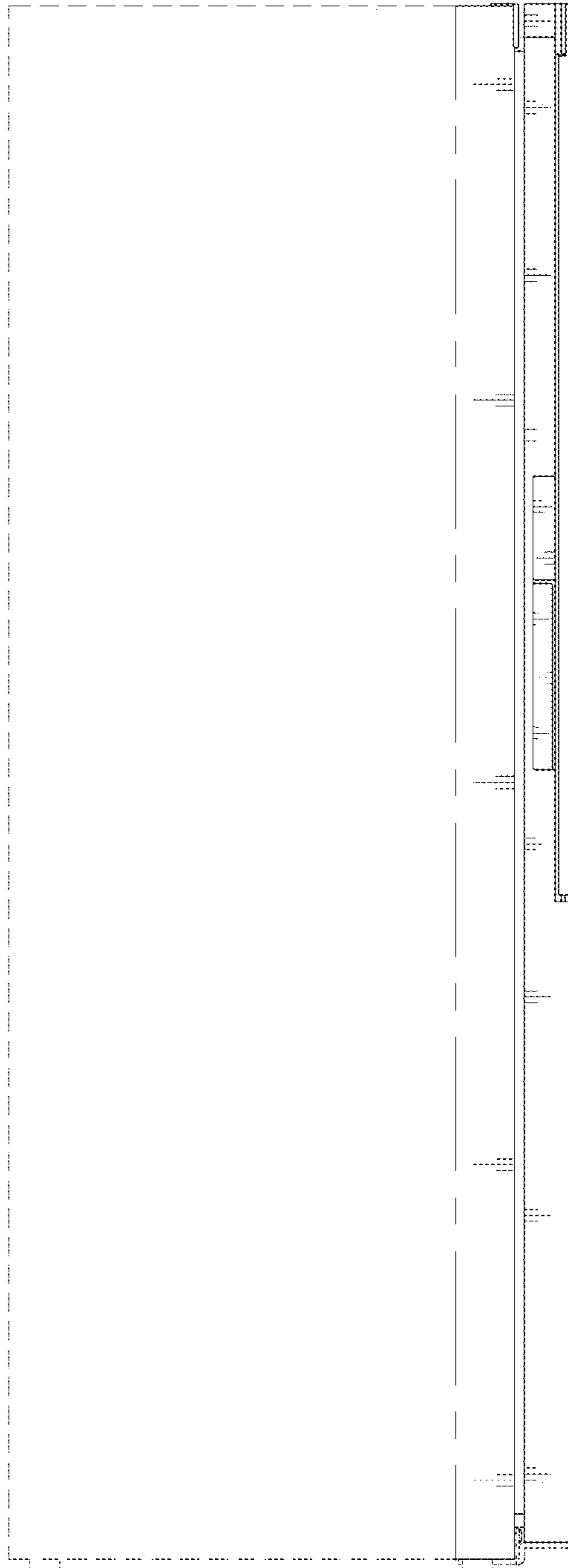

FIG. 5

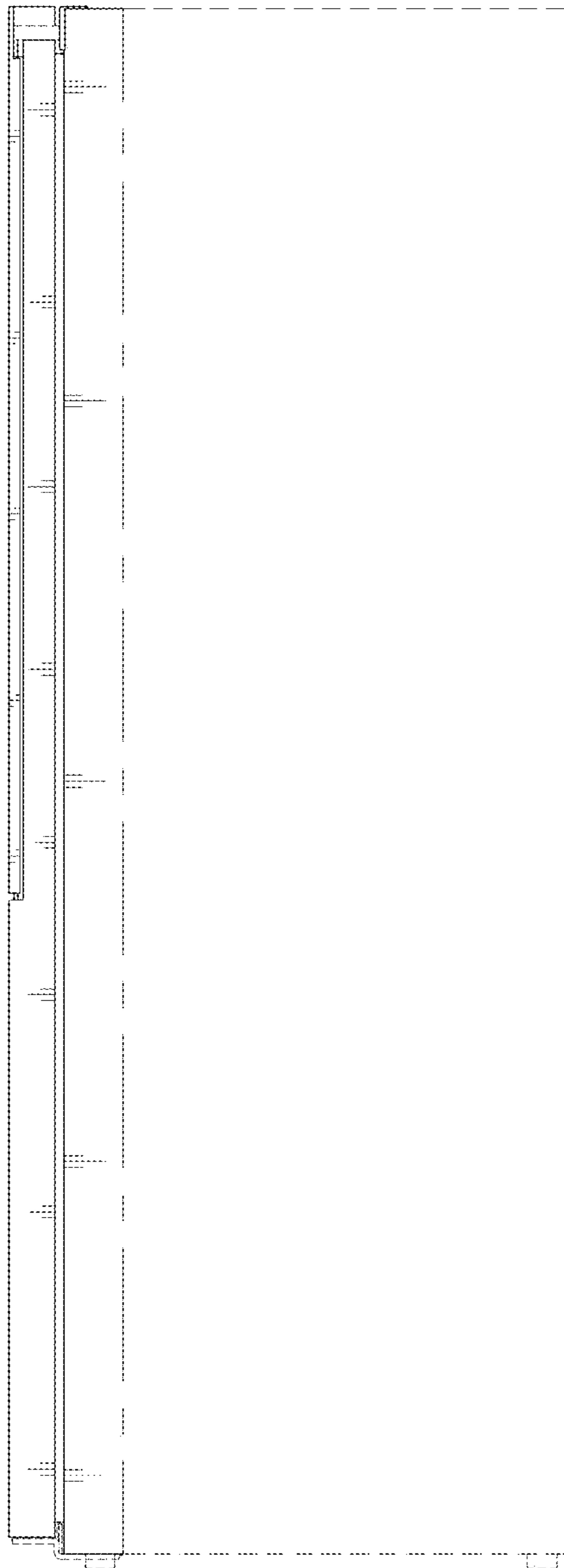

FIG. 6

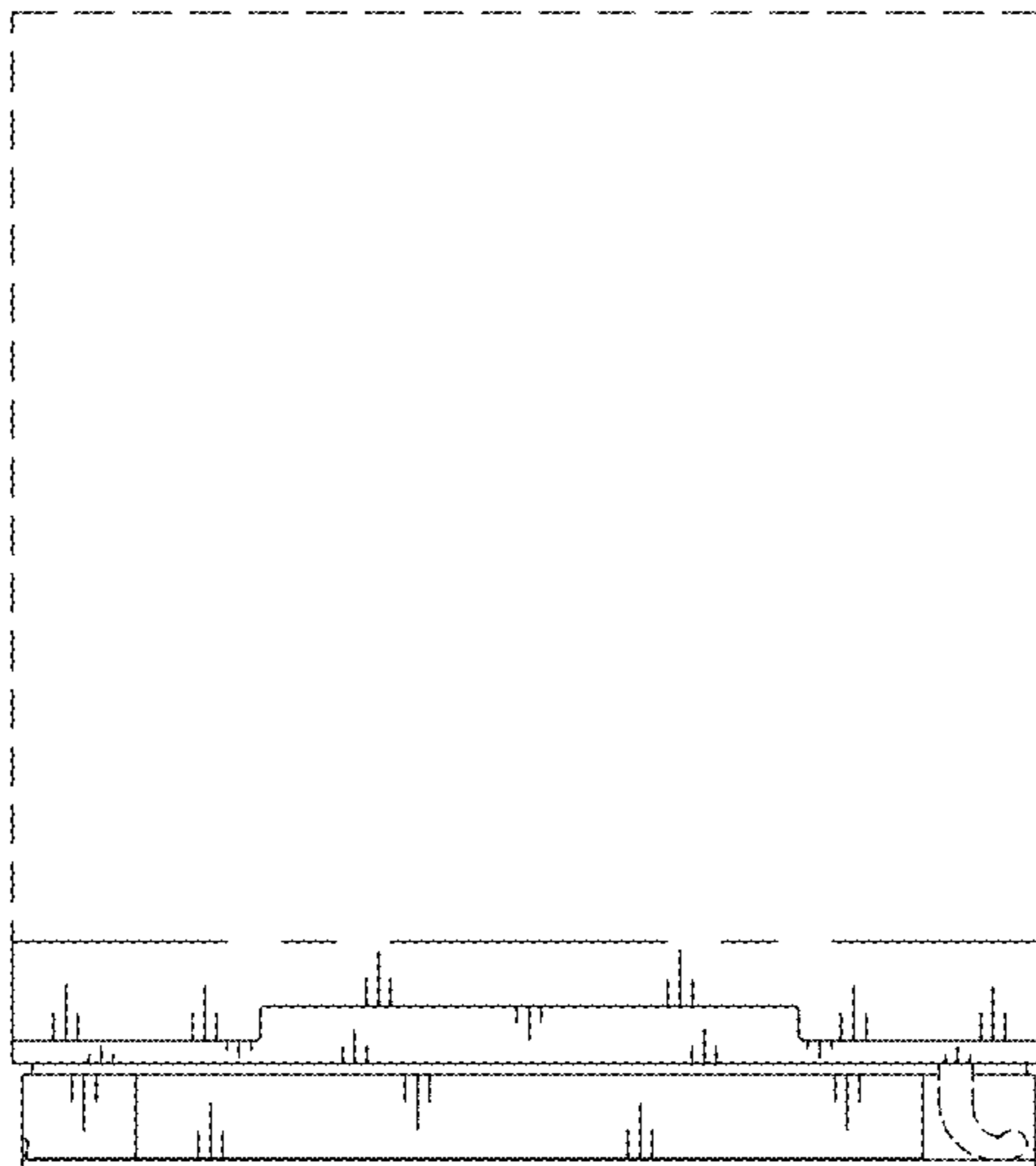



FIG. 7

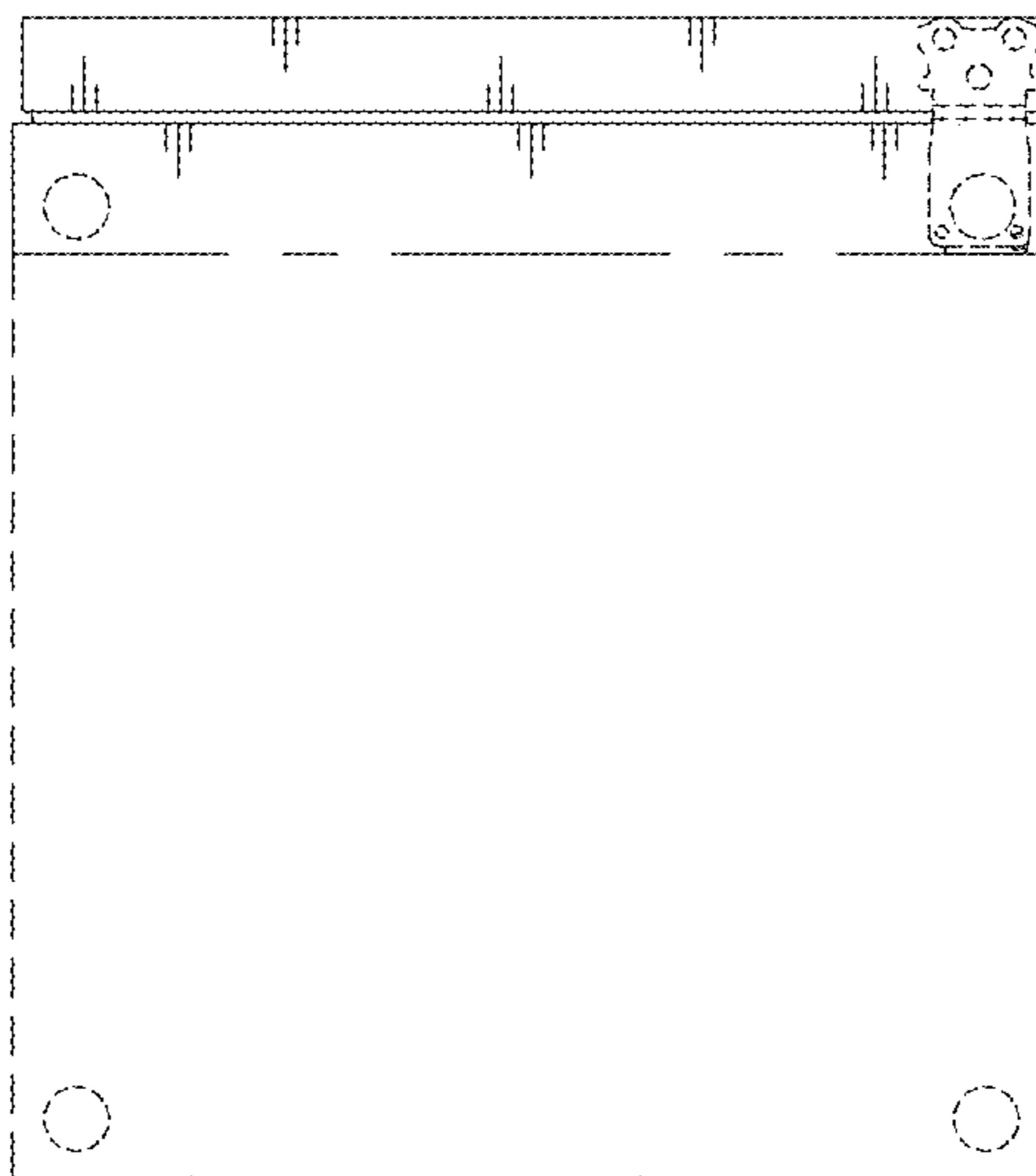

FIG. 8

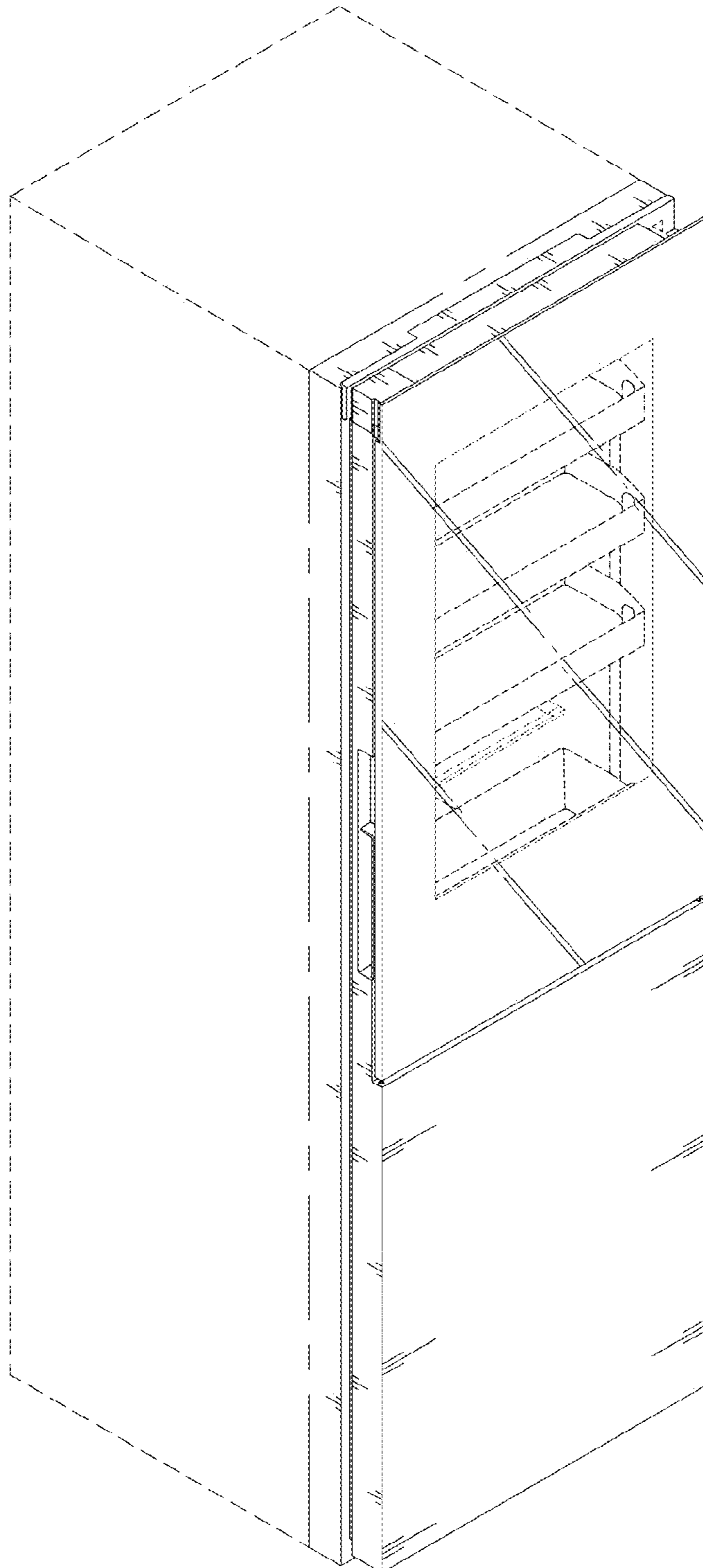

FIG. 9

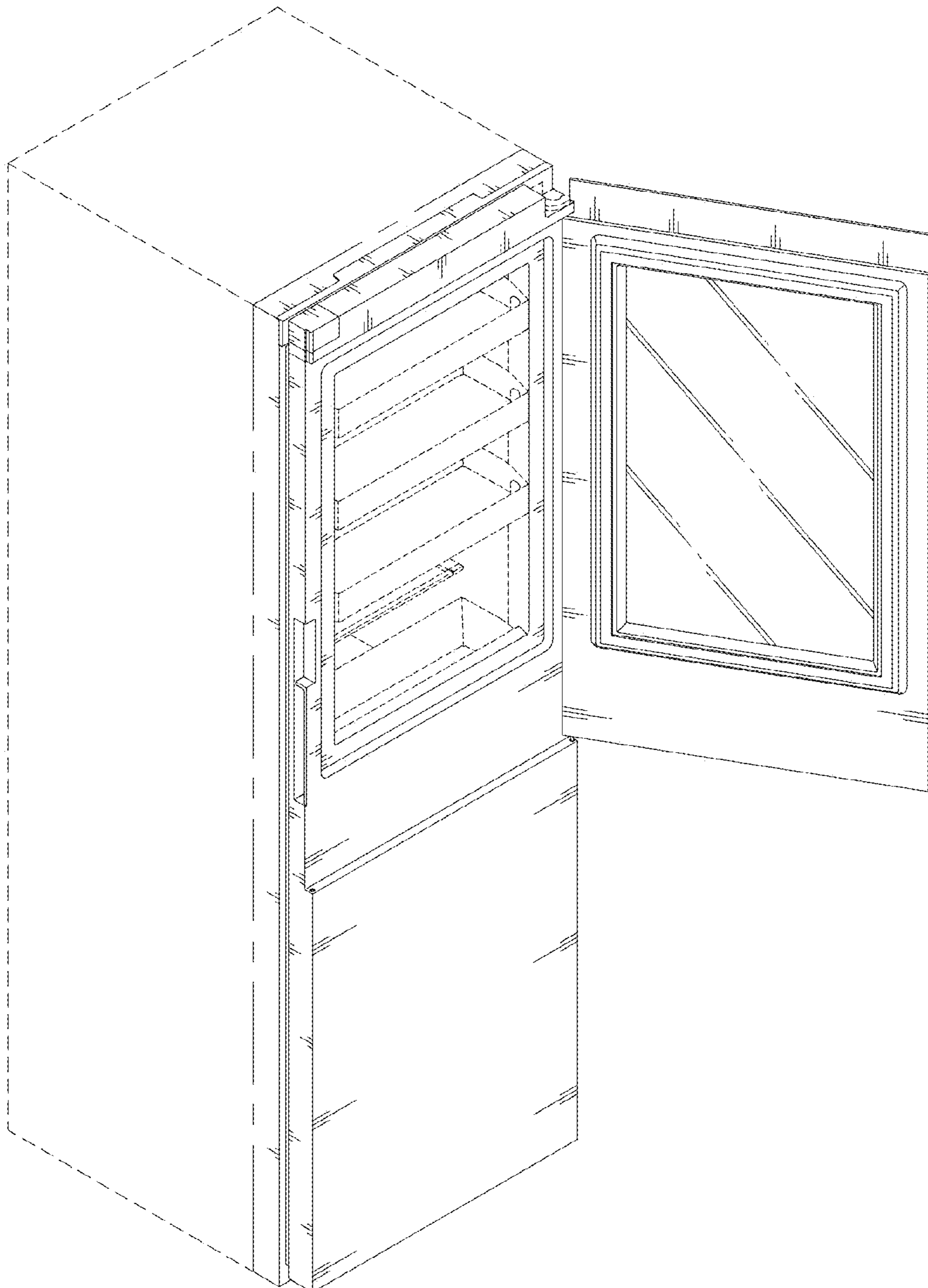

FIG. 10

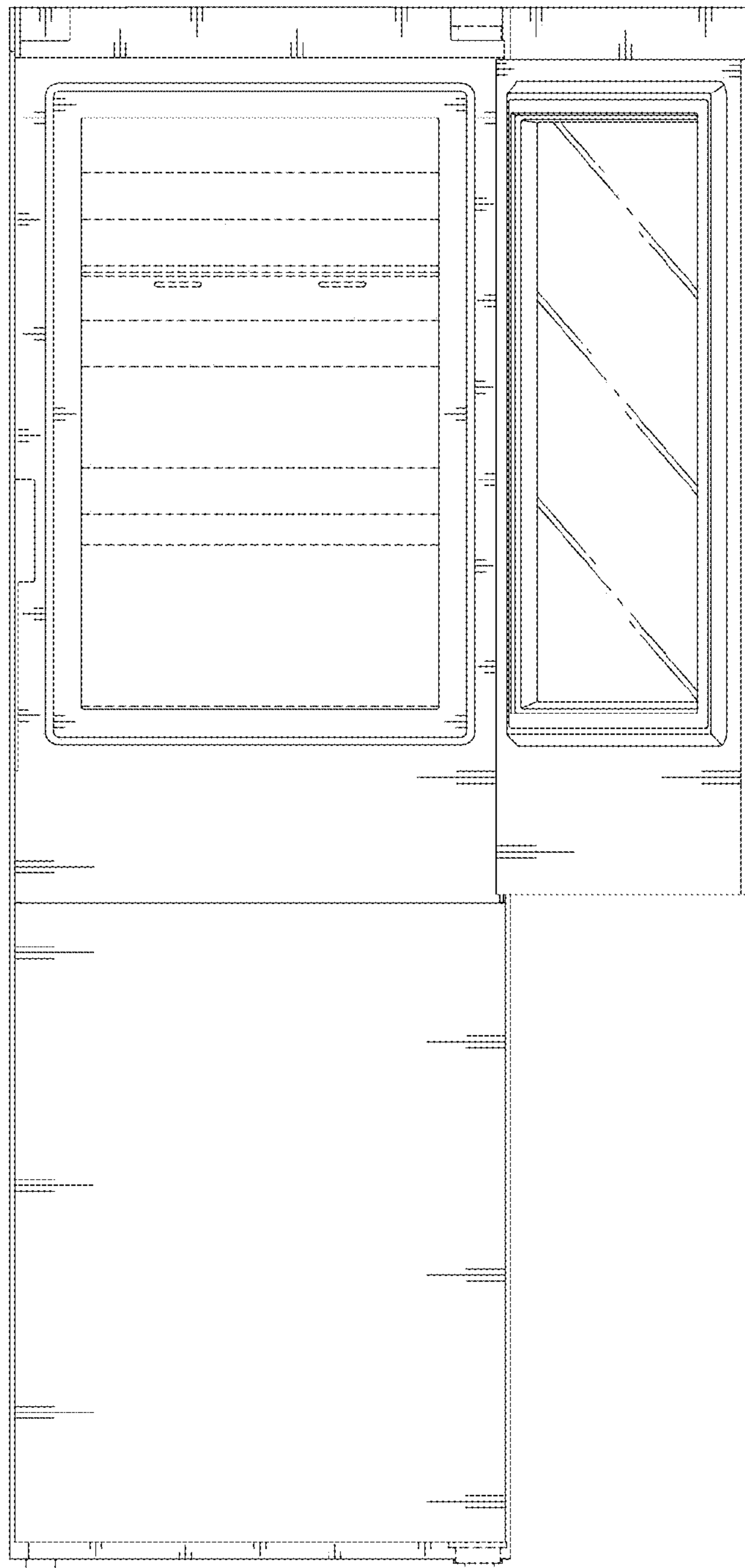

FIG. 11

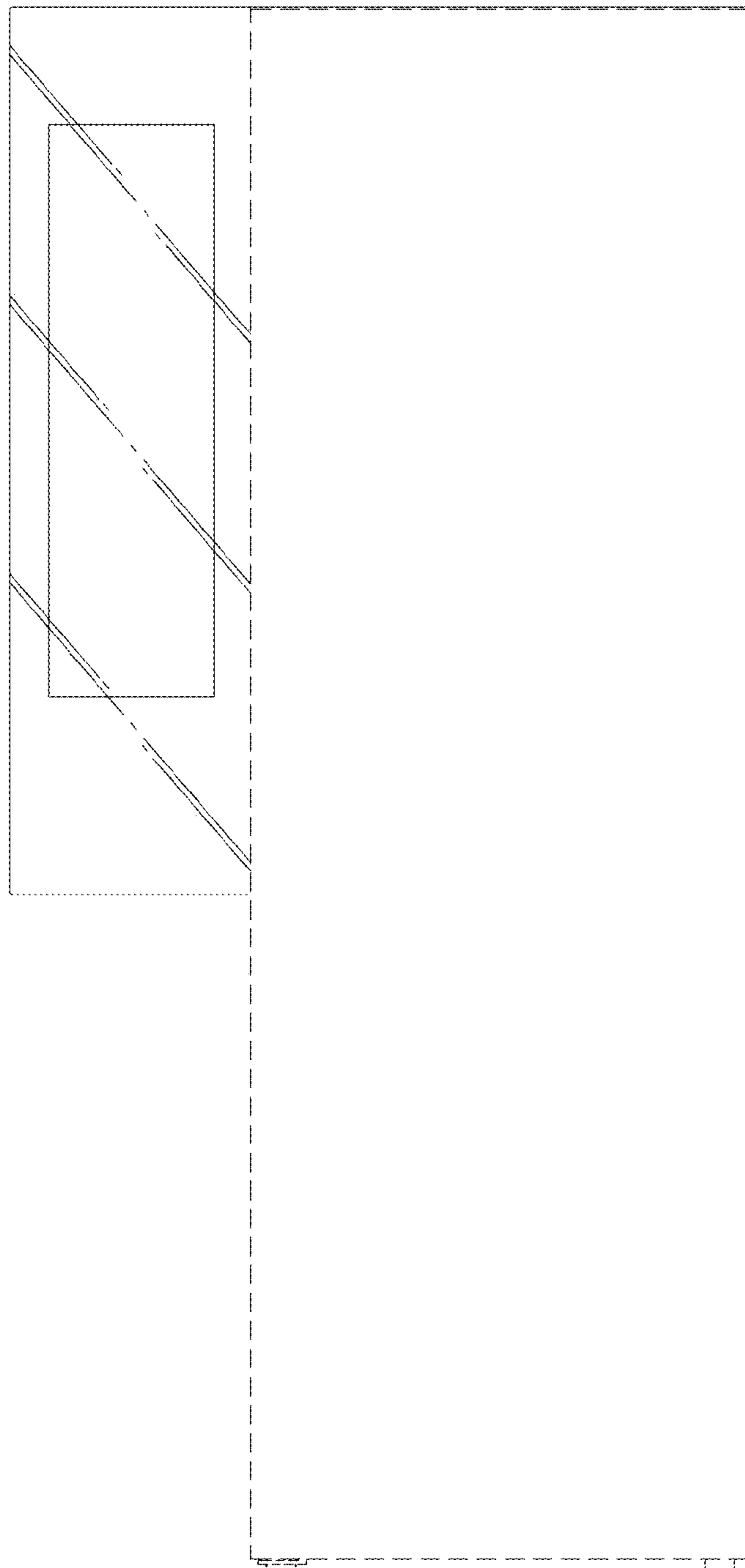

FIG. 12

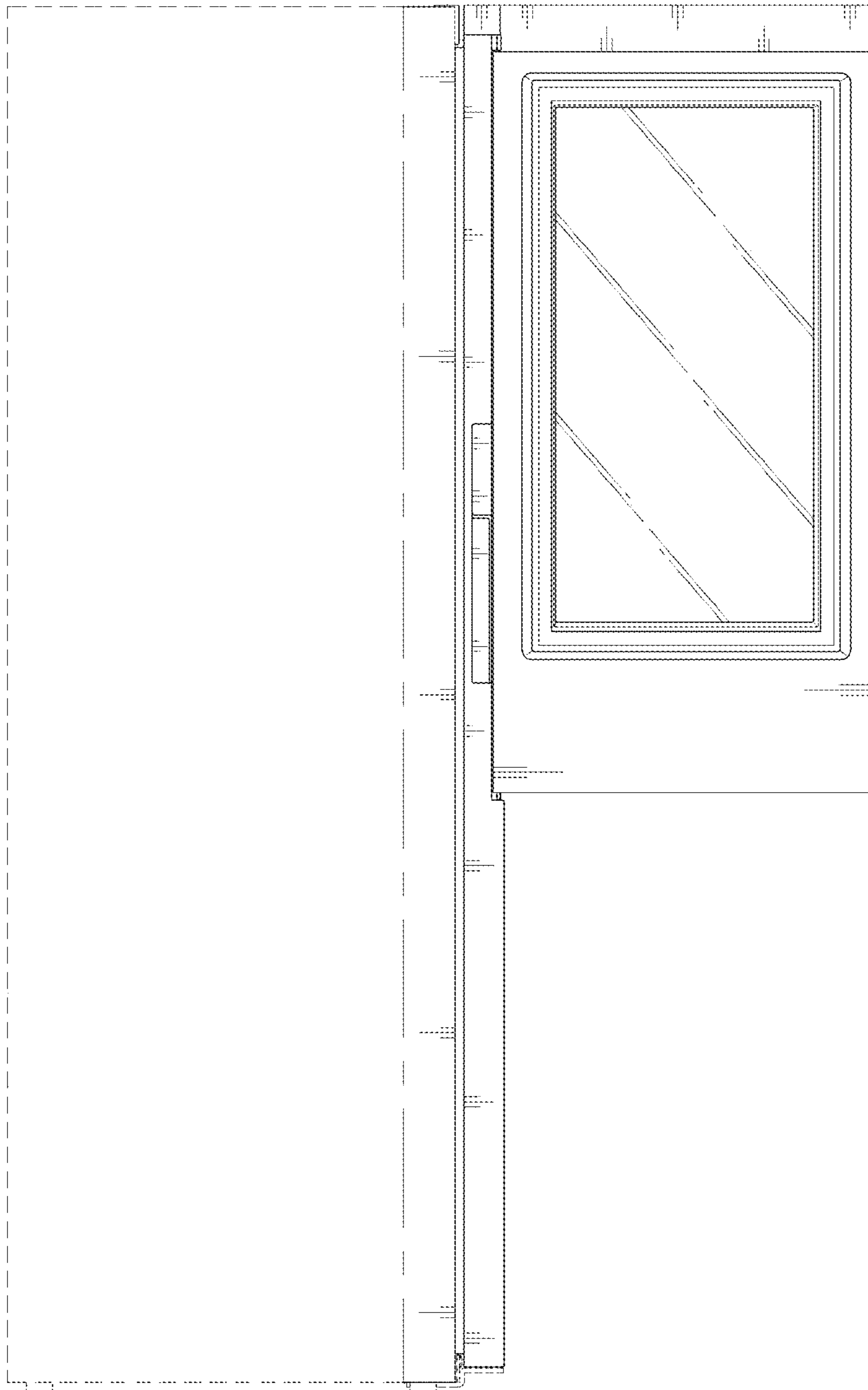

FIG. 13

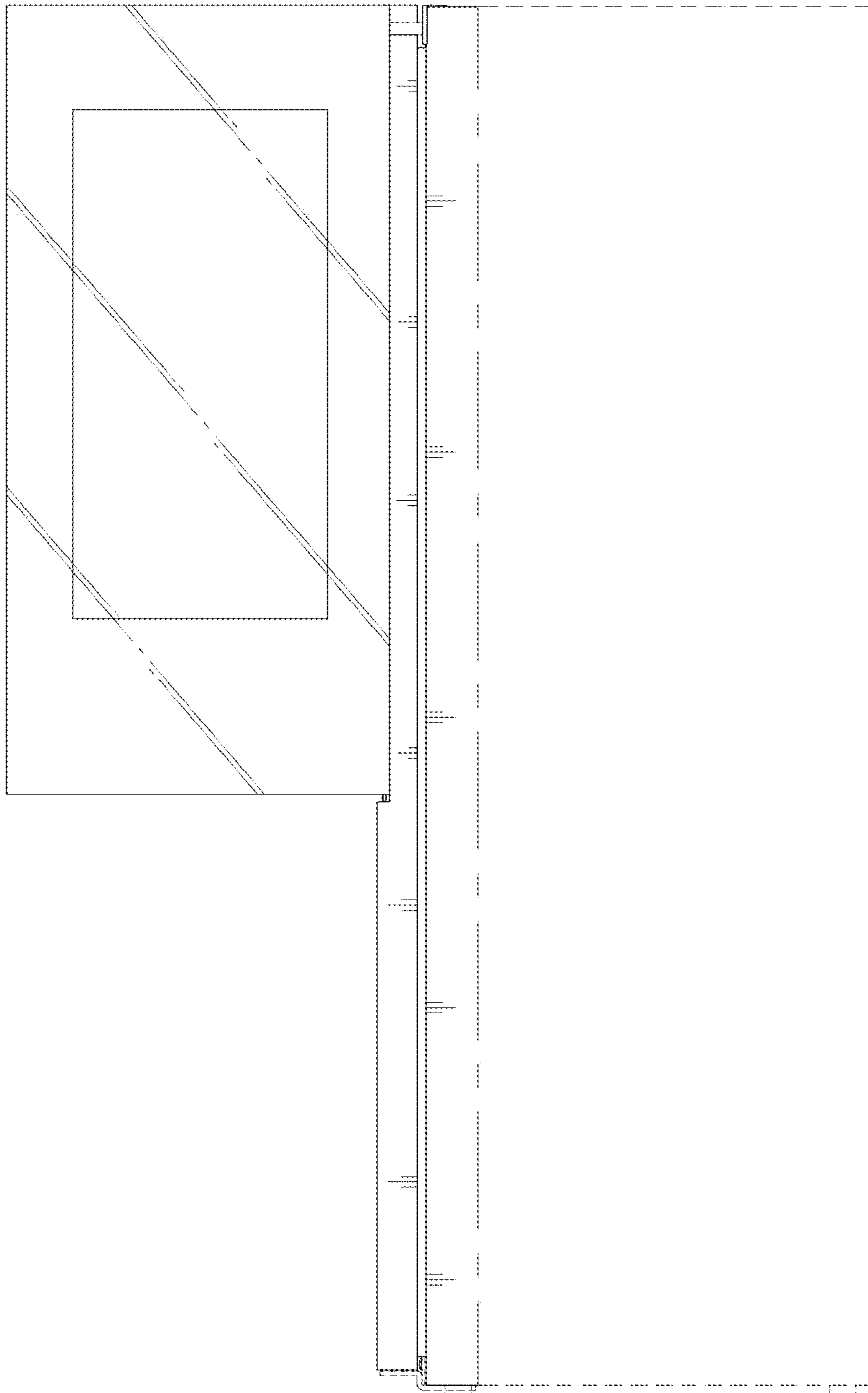

FIG. 14

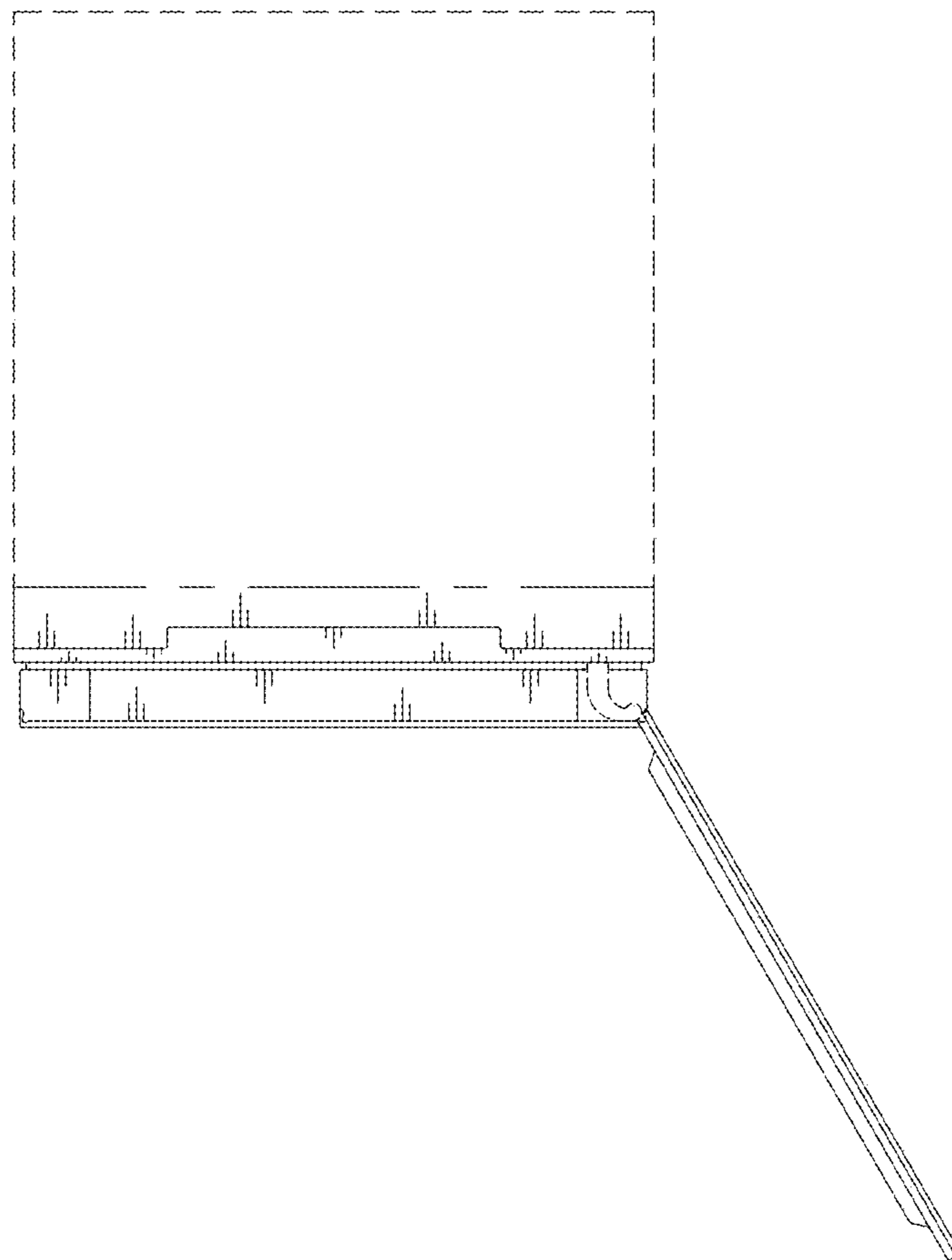



FIG. 15

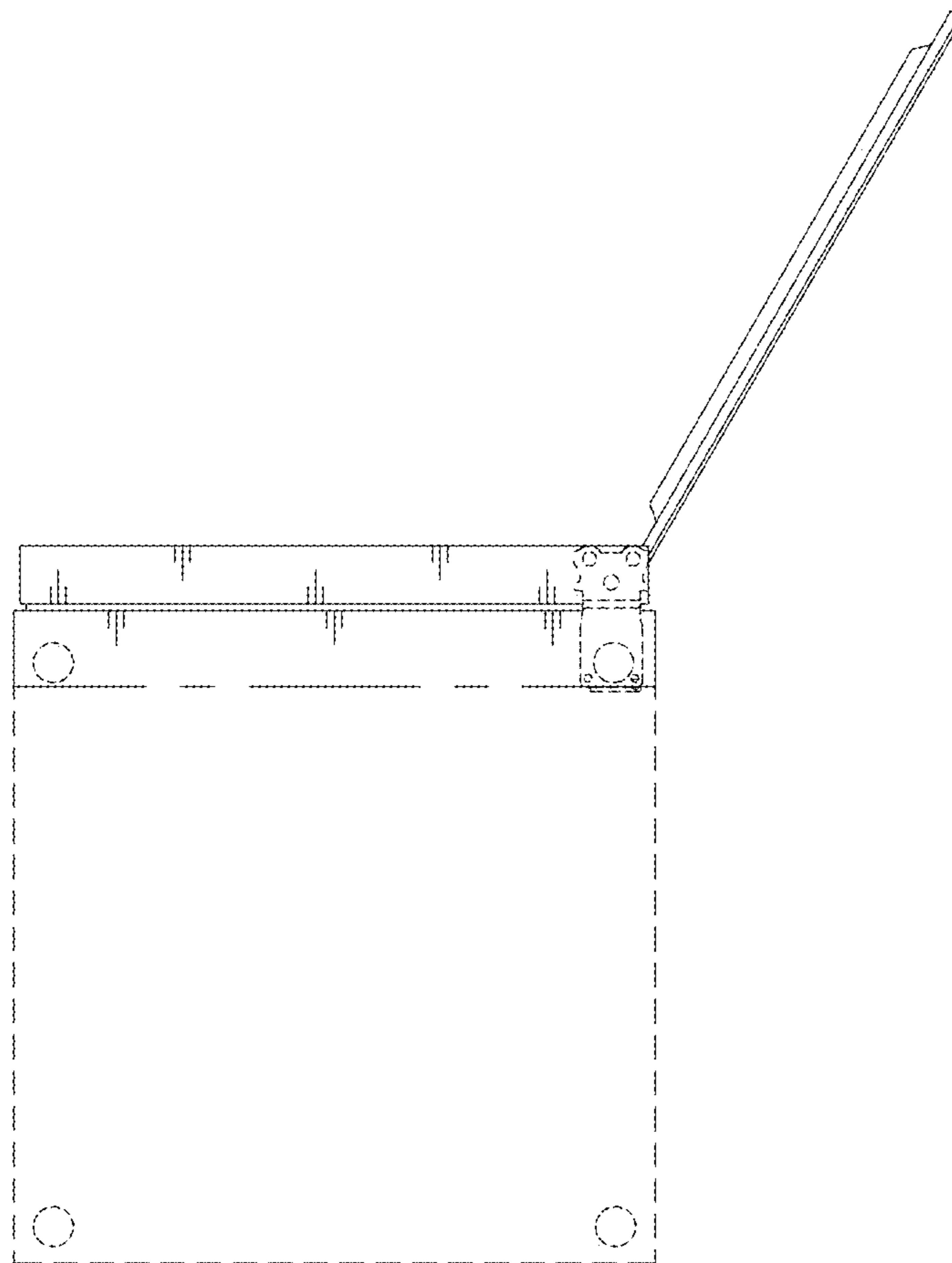

FIG. 16

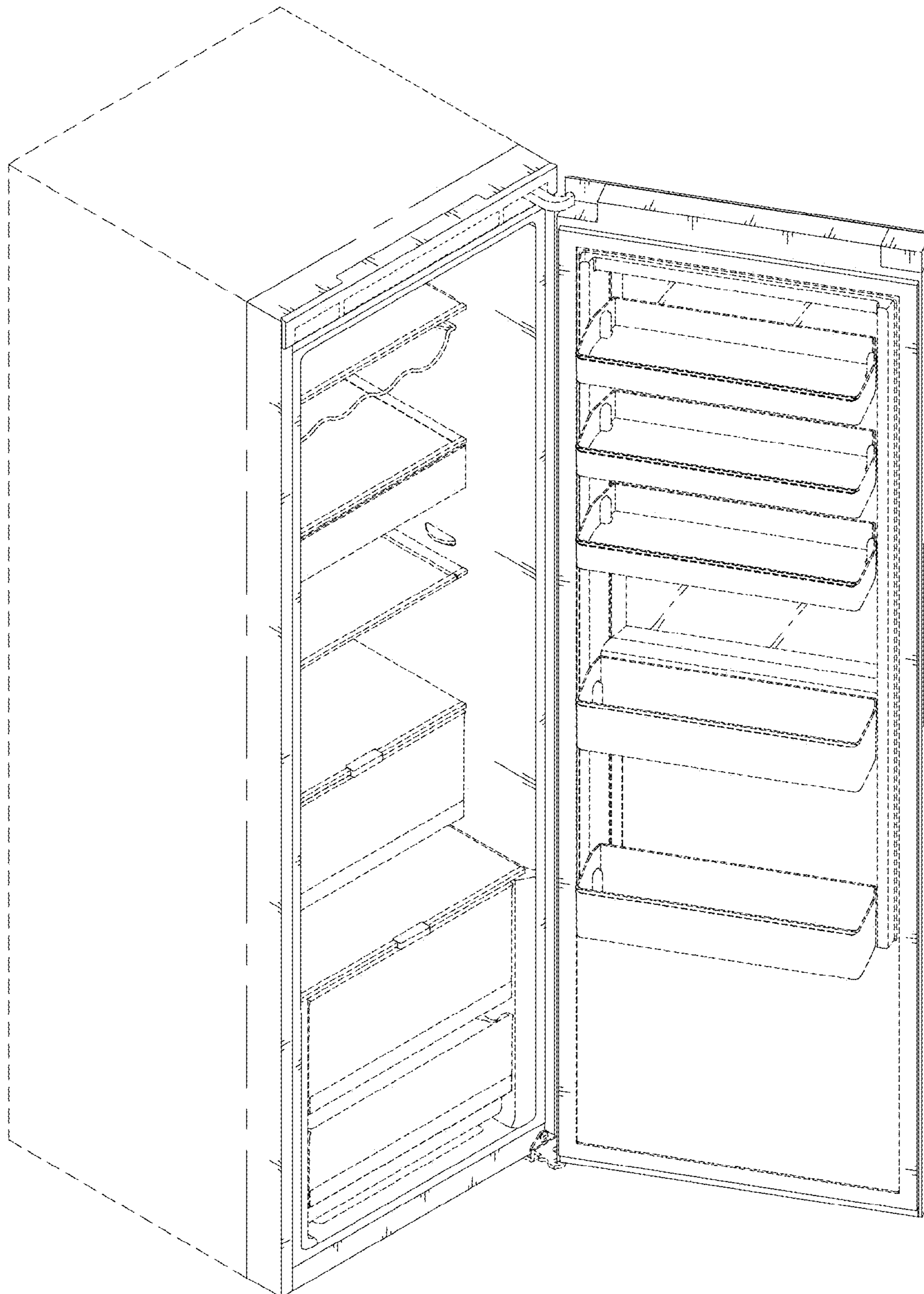

FIG. 17

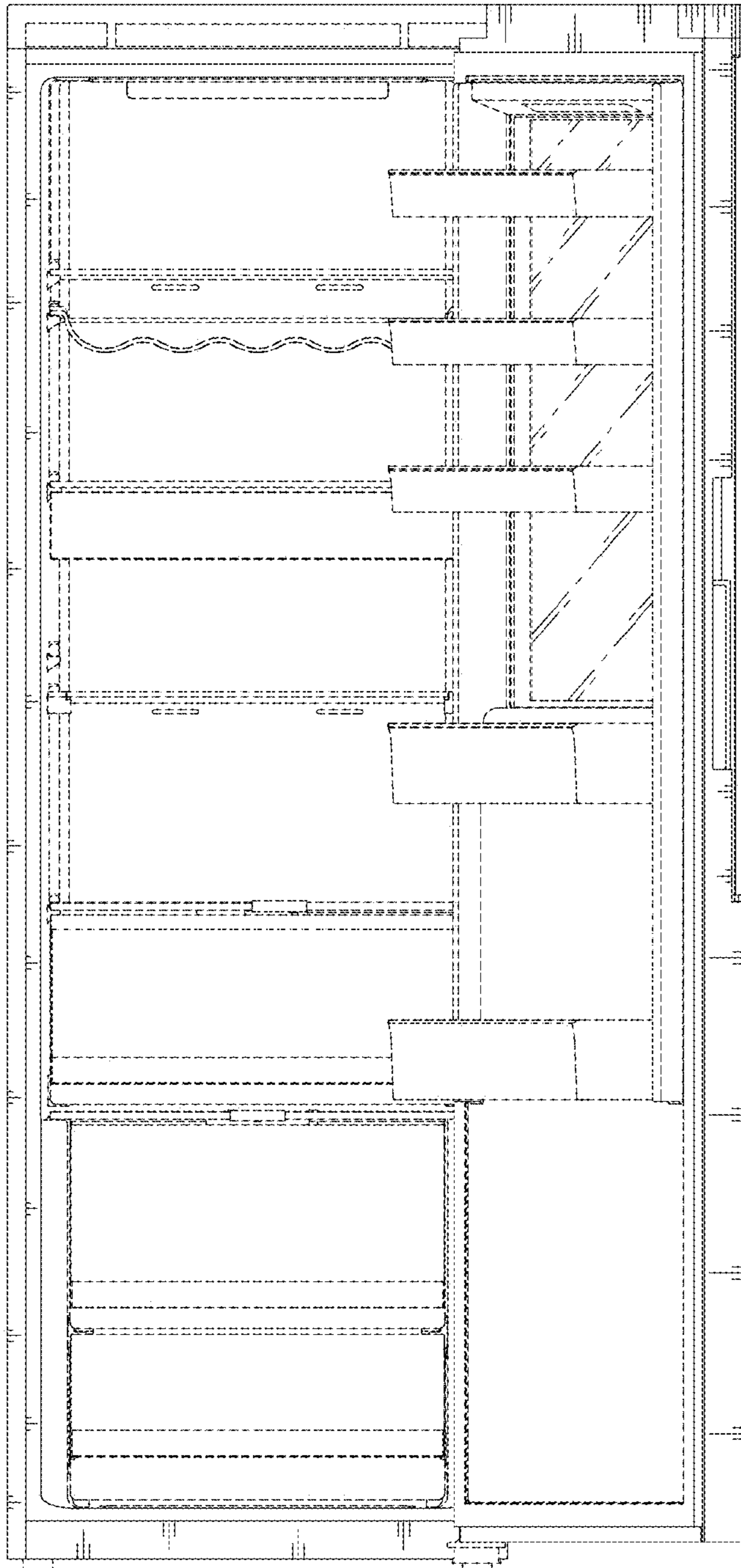

FIG. 18

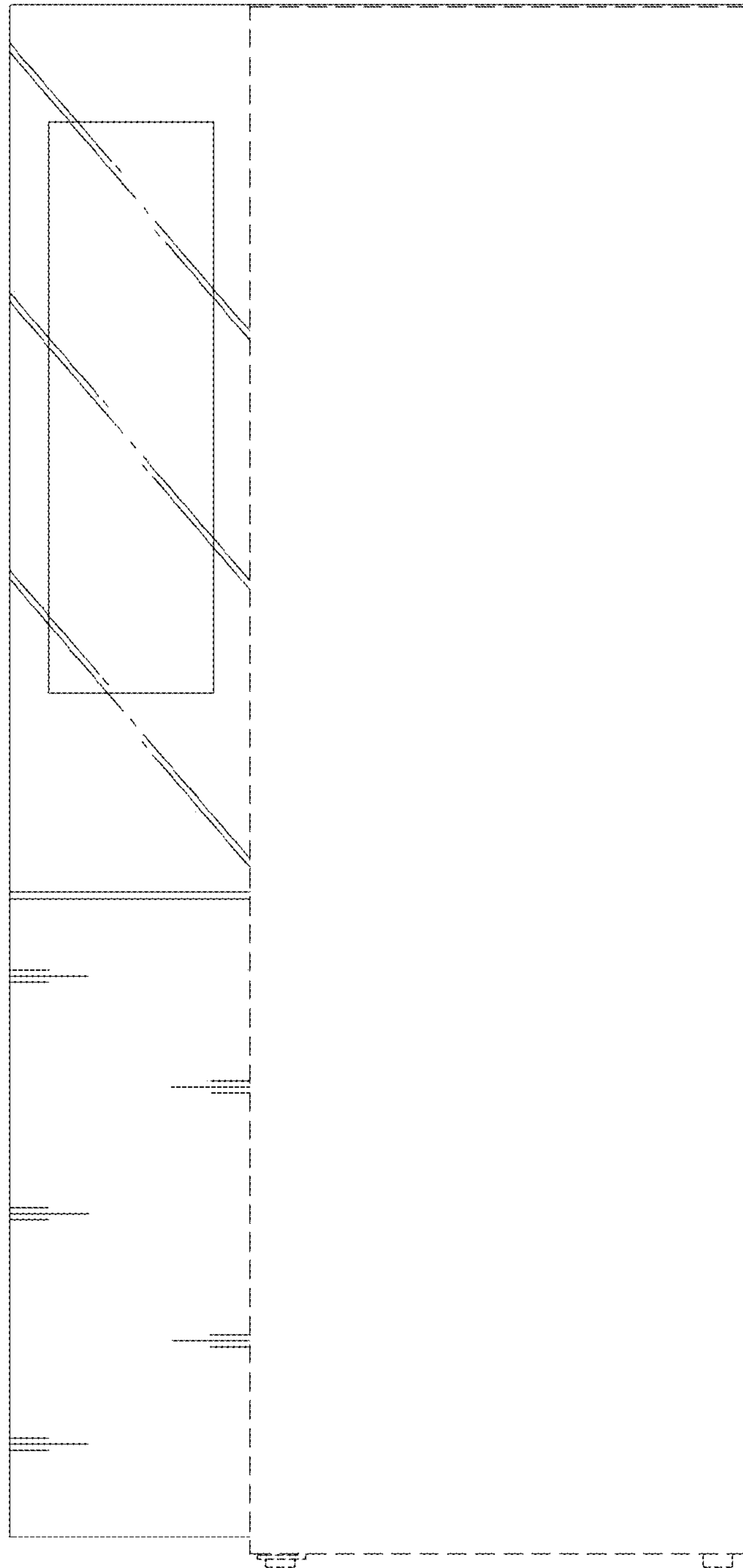

FIG. 19

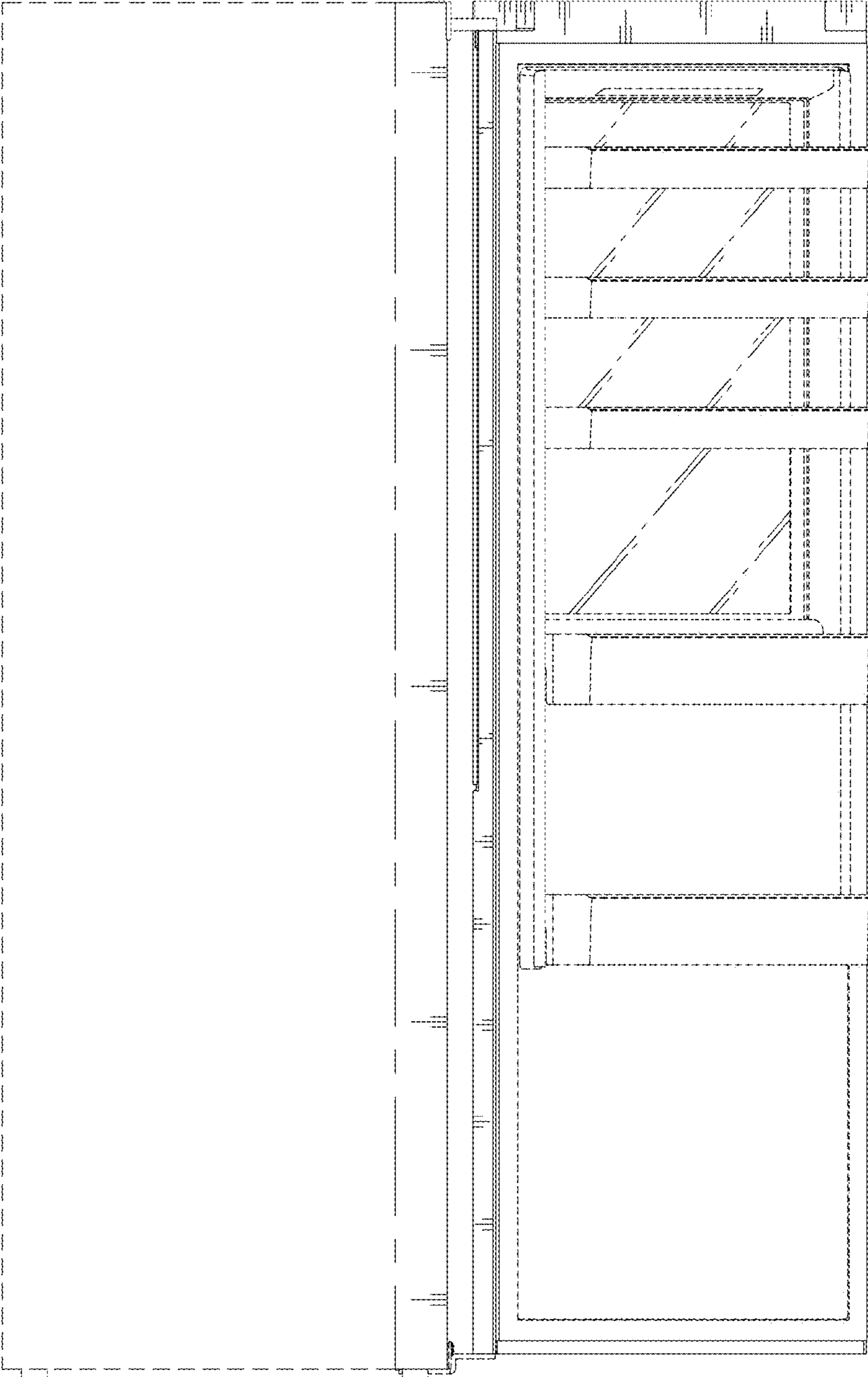

FIG. 20

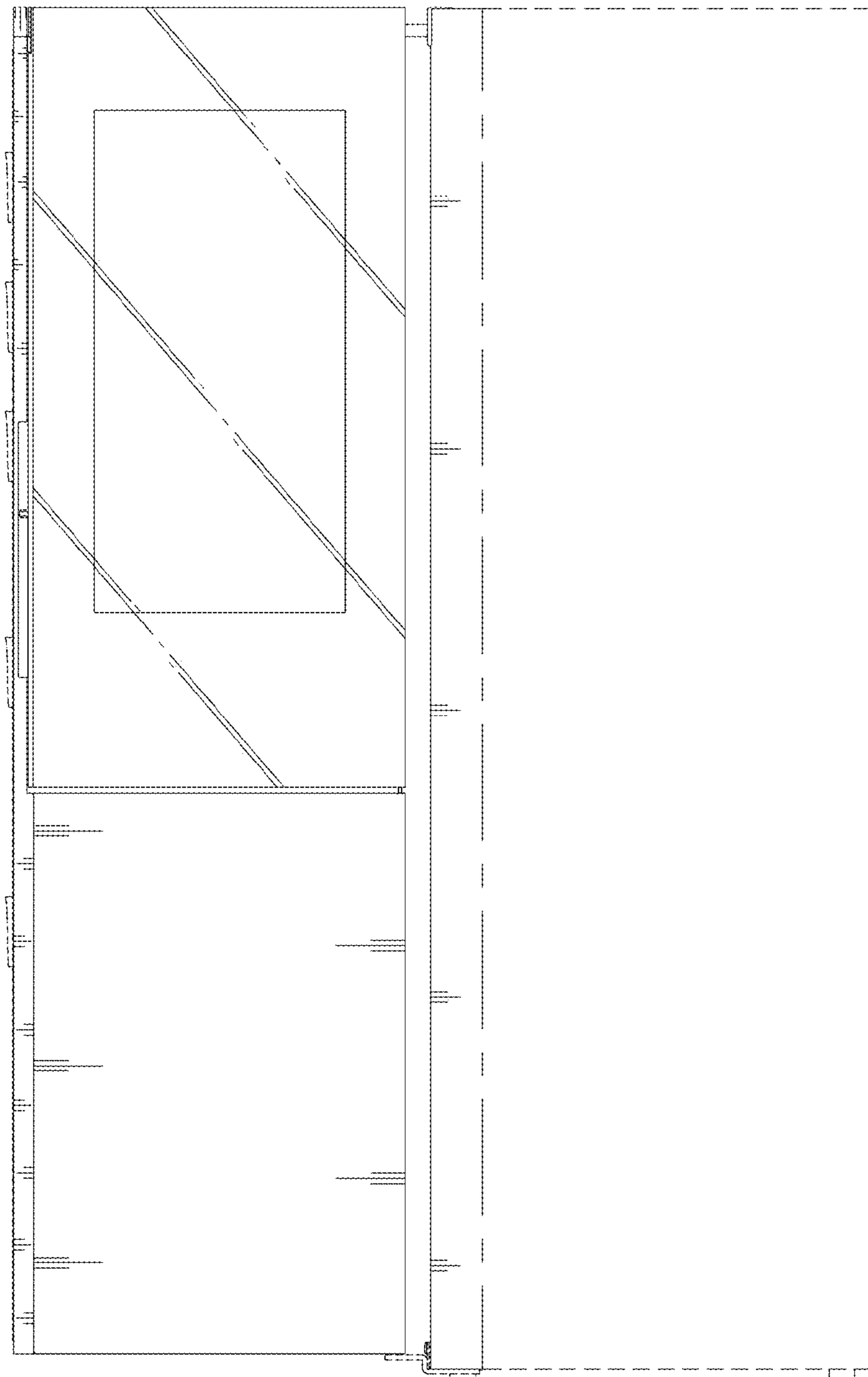

FIG. 21

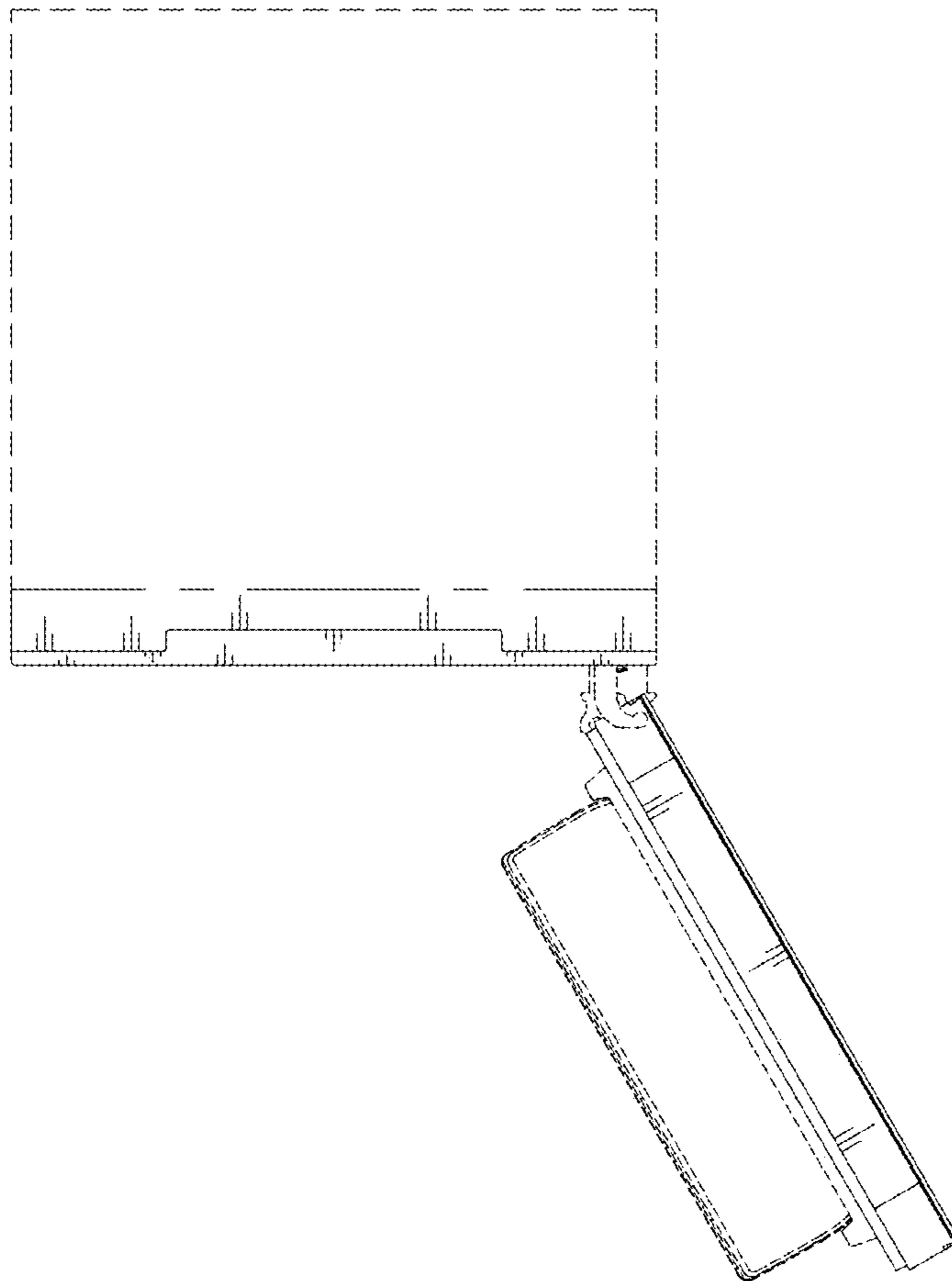

FIG. 22

