



US00D961583S

(12) **United States Design Patent** (10) **Patent No.:** **US D961,583 S**
Chung (45) **Date of Patent:** **** Aug. 23, 2022**

- (54) **SMART WATCH**
- (71) Applicant: **Samsung Electronics Co., Ltd.**,
Suwon-si (KR)
- (72) Inventor: **Insik Chung**, Suwon-si (KR)
- (73) Assignee: **Samsung Electronics Co., Ltd.**,
Suwon-si (KR)
- (**) Term: **15 Years**
- (21) Appl. No.: **29/751,736**
- (22) Filed: **Sep. 23, 2020**

(30) **Foreign Application Priority Data**

Jun. 1, 2020 (KR) 30-2020-0024162

- (51) **LOC (13) Cl.** **14-02**
- (52) **U.S. Cl.**
USPC **D14/344**; D10/38
- (58) **Field of Classification Search**
USPC ... D14/138 R, 144, 341, 344, 346, 388, 389,
D14/390, 496; D10/30-32, 38, 70;
D24/167, 186, 187
CPC G04G 17/00; G04G 17/045; G04G 17/08;
G04G 17/083; G04G 21/00; G04G 21/02;
G04G 21/025; G04G 21/06; G04G 21/08;
G04G 99/006; G06F 1/163; A44C
5/0007; A44C 5/0015; A44C 5/0046;
A44C 5/0053; A44C 5/2052; A44C
5/2071
See application file for complete search history.

(56) **References Cited**

U.S. PATENT DOCUMENTS

- D733,580 S * 7/2015 Cerrato D10/38
- D739,268 S * 9/2015 Lammers-Meis D10/38
- D795,086 S * 8/2017 Monachon D10/30
- D807,352 S * 1/2018 Bang D14/344
- D817,952 S * 5/2018 Choi D14/344

- D817,953 S * 5/2018 Choi D14/344
 - D836,465 S * 12/2018 Register D10/30
 - D844,458 S * 4/2019 Lillquist D10/30
 - D857,010 S * 8/2019 Choi D14/344
 - D893,474 S * 8/2020 Chung D14/344
- (Continued)

FOREIGN PATENT DOCUMENTS

- CN 2018306711650 9/2019
 - CN 2019303821901 4/2020
- (Continued)

OTHER PUBLICATIONS

Samsung Galaxy Watch is here: www.androidauthority.com, Aug. 9, 2018. <https://www.androidauthority.com/samsung-galaxy-watch-2-893420/> (Year: 2018).*

(Continued)

Primary Examiner — Cynthia Ramirez
Assistant Examiner — Kwabena A. Ankobiah
(74) *Attorney, Agent, or Firm* — NSIP Law

(57) **CLAIM**

I claim the ornamental design for a smart watch, as shown and described.

DESCRIPTION

FIG. 1 is a front perspective view of a smart watch showing my new design;
FIG. 2 is a front view thereof;
FIG. 3 is a rear view thereof;
FIG. 4 is a left-side view thereof;
FIG. 5 is a right-side view thereof;
FIG. 6 is a top view thereof;
FIG. 7 is a bottom view thereof; and,
FIG. 8 is a rear perspective view thereof.
The broken lines in the figures show portions of the smart watch which form no part of the claimed design.

1 Claim, 8 Drawing Sheets

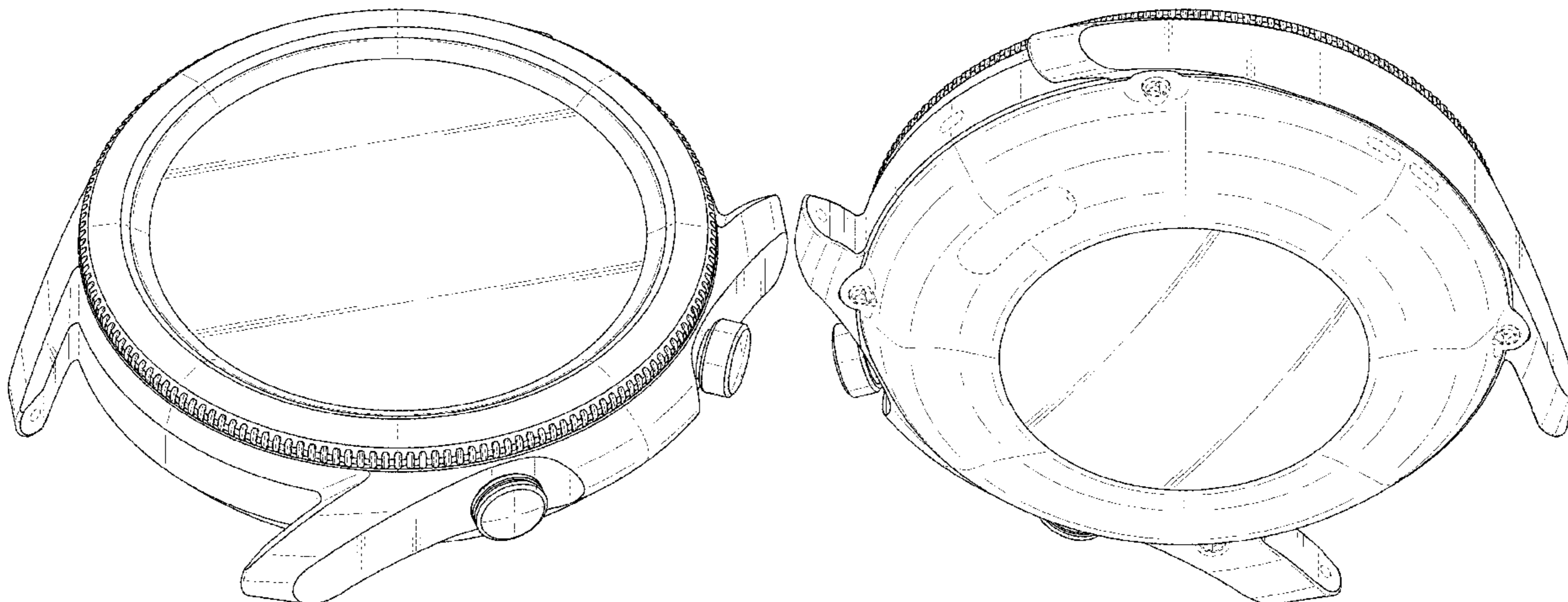

(56)

References Cited

U.S. PATENT DOCUMENTS

D902,920 S	*	11/2020	Bang	D14/344
D910,616 S	*	2/2021	Oh	D14/344
D912,542 S	*	3/2021	Moilanen	D14/344
D923,002 S	*	6/2021	Hong	D14/344
D926,054 S	*	7/2021	Cheng	D10/38
D937,101 S	*	11/2021	Yuan	D14/344
D951,245 S	*	5/2022	Chung	D14/344

FOREIGN PATENT DOCUMENTS

CN	2019303822069	4/2020
EM	003728708-0007	2/2017
KR	30-2017-0005521	1/2018
KR	30-2019-0005784	7/2019
KR	30-2019-0026052	3/2020
KR	301096348.0000	* 2/2021

OTHER PUBLICATIONS

Samsung Gear S3 Classic Smartwatch, www.amazon.com, Nov. 7, 2018. <https://www.amazon.com/Samsung-Classic-Smartwatch-Bluetooth-SM-R770NZSAXAR/dp/B01M1OXXT8?th=1> (Year: 2018).*

Samsung Galaxy Watch 3, www.amazon.com, Aug. 6, 2020. https://www.amazon.com/Samsung-Bluetooth-Advanced-monitoring-Tracking/dp/B089DNNJ1S/ref=psdc_7939901011_t3_B08HL5K8JB (Year: 2020).*

OAS strap. “[Mr.G] grows crazy! Smartwatch industry on the continent.” [2018] www.blog.naver.com Dec. 27, 2018 <<https://blog.naver.com/leechmoney/221406620922>>.

Garmin. “Garmin Vivomube Lux Hybrid Smartwatch” [2020] www.blog.naver.com Mar. 16, 2020 <<https://blog.naver.com/xogus3674/221856753315>>.

Xiaomi. “[Secret Special Deal] Amazing Fit GTR Smartwatch Hangual Edition 47mm [Stainless Steel/aluminum alloy]” [2020] www.e-himart.com Mar. 18, 2020 <<http://www.e-himart.co.kr/app/goods/goodsDetail?goodsNo=0005764597>>.

“Samsung Electronics Gear S3 Golf Edition Frontier Smartwatch Golf Distance Finder Samsung Gear S3” [2020] www.golfbuddyshop.com Sep. 23, 2020 <<http://golfbuddyshop.com/product/%EC%82%BC%EC%84%B1%EC%A0%84%EC%9E%90-gear-s3-%EA%B3%A8%ED%94%84%EC%97%90%EB%94%94%EC%85%98-%ED%94%84%EB%A1%A0%ED%8B%B0%EC%96%B4-%EC%8A%A4%EB%A7%88%ED%8A%B8%EC%9B%8C%EC%B9%98-%EA%B3%A8%ED%94%84%EA%B1%B0%EB%A6%AC-%EC%B8%A1%EC%A0%95%EA%B8%B0-%EC%82%BC%EC%84%B1%EA%B8%B0%EC%96%B4s3/571/>>.

Ko, Hyun-Jun. “Montblanc Recommends Smartwatch Summit 2” [2019] www.wedding21news.co.kr Nov. 2019 <<http://www.wedding21news.co.kr/news/articleView.html?idxno=227002>>.

* cited by examiner

FIG. 1

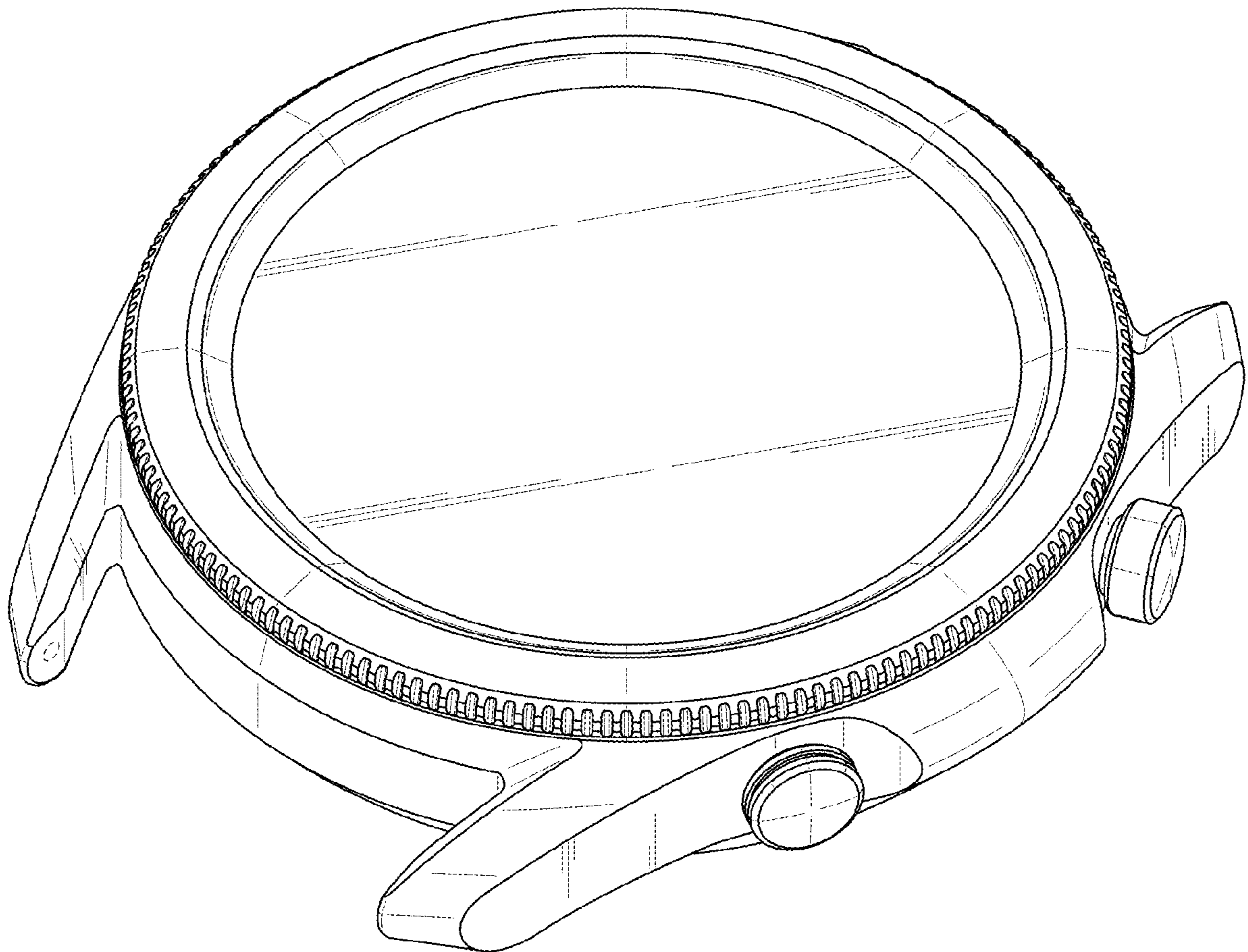

FIG. 2

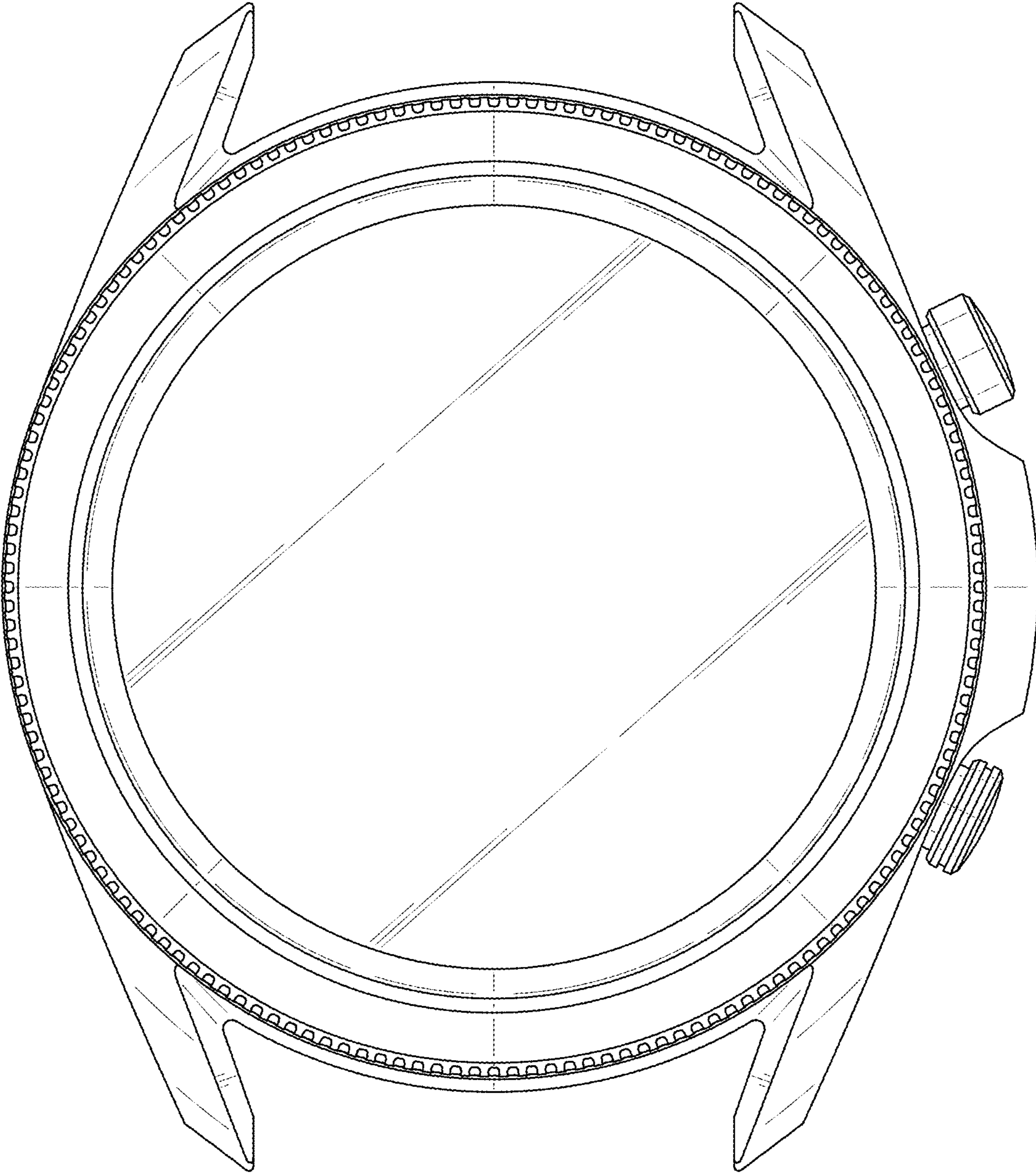

FIG. 3

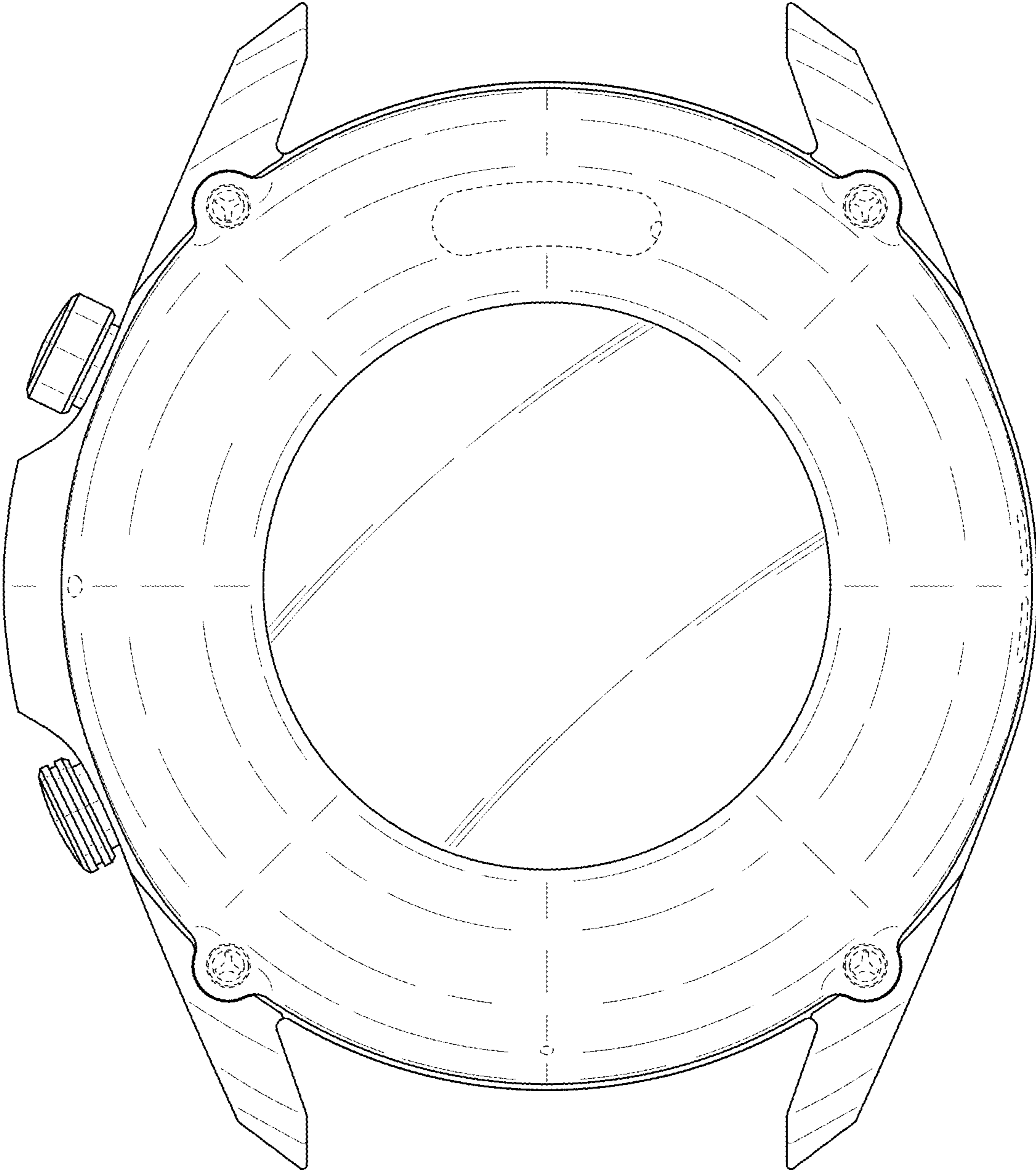

FIG. 4

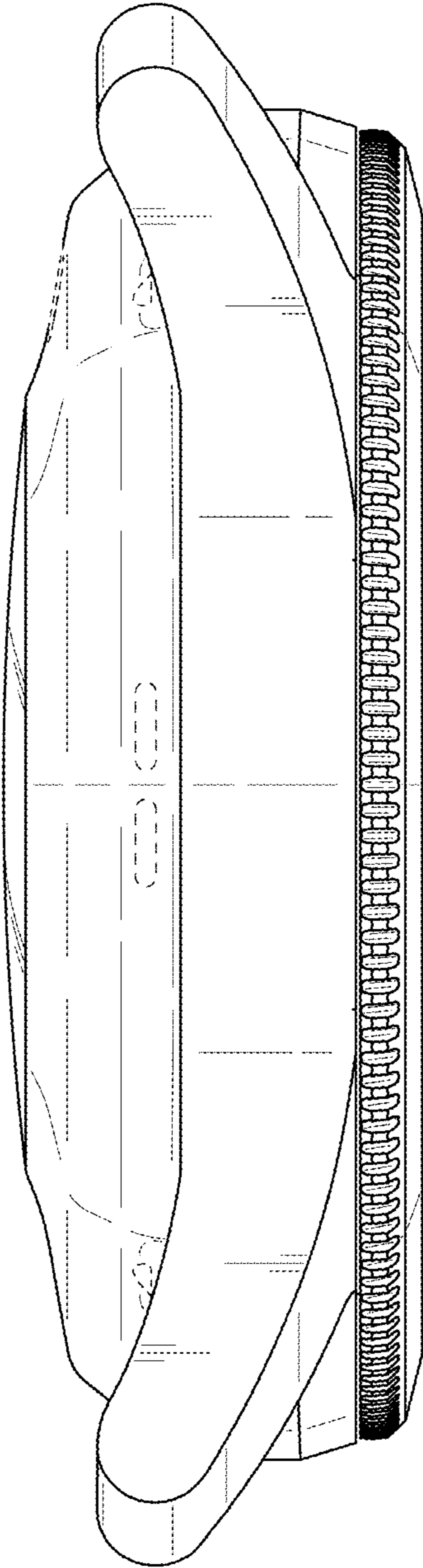

FIG. 5

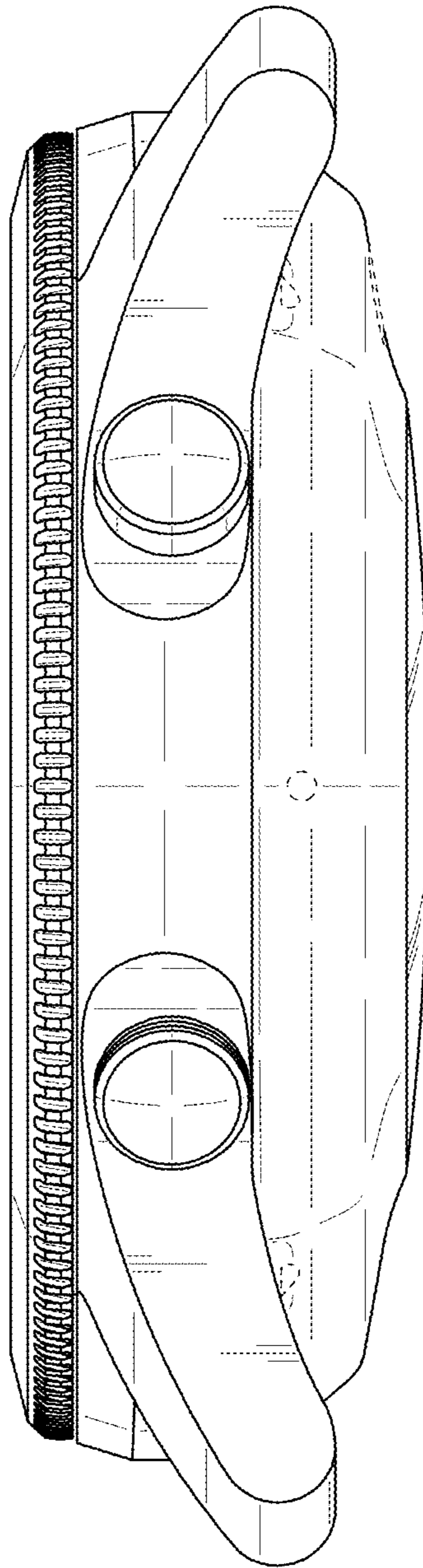

FIG. 6

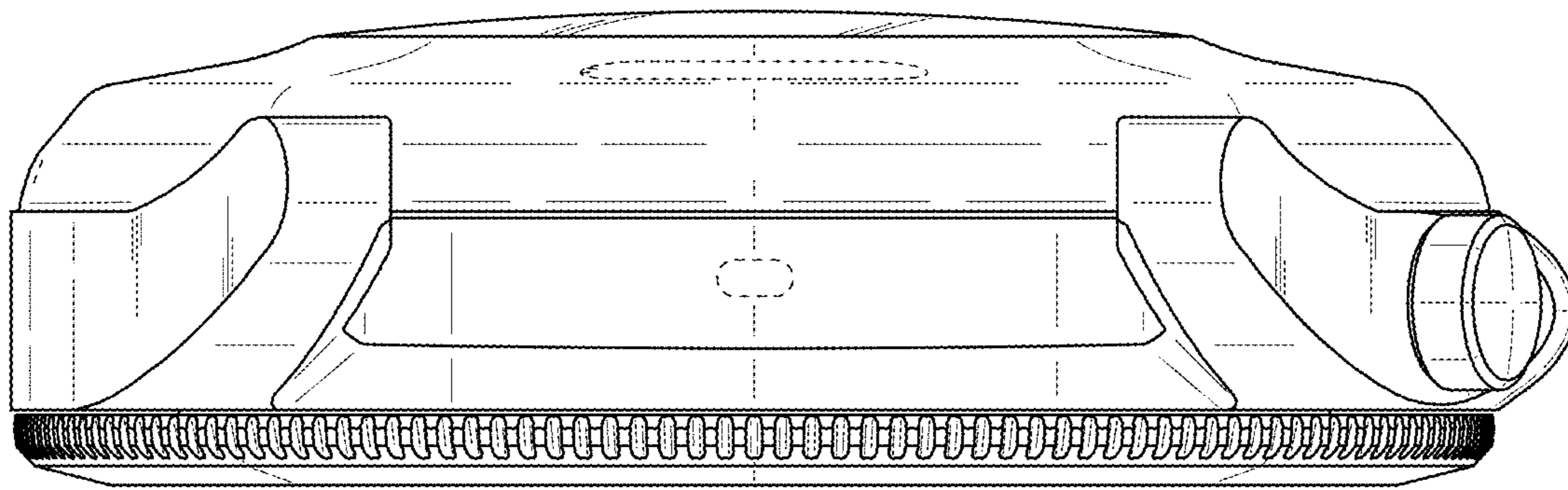

FIG. 7

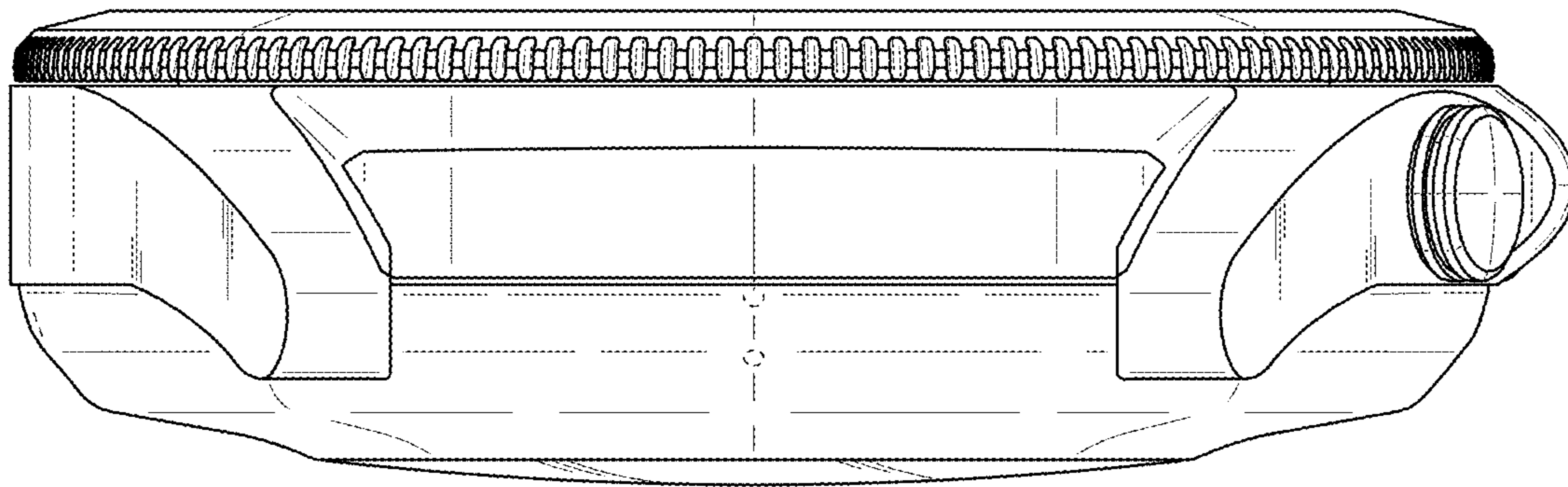

FIG. 8

