

US00D961570S

(12) **United States Design Patent** (10) **Patent No.:** **US D961,570 S**
Jang et al. (45) **Date of Patent:** **** Aug. 23, 2022**

(54) **ELECTRONIC DEVICE**
(71) Applicant: **Samsung Electronics Co., Ltd.**,
Suwon-si (KR)
(72) Inventors: **Seung-Ho Jang**, Suwon-si (KR);
Da-Wi Lee, Suwon-si (KR); **Jong-Bo Jung**,
Suwon-si (KR); **Mi-Ri Lee**,
Suwon-si (KR)

(73) Assignee: **Samsung Electronics Co., Ltd.**,
Suwon-si (KR)

(**) Term: **15 Years**

(21) Appl. No.: **29/770,209**

(22) Filed: **Feb. 10, 2021**

(30) **Foreign Application Priority Data**

Aug. 10, 2020 (KR) 30-2020-0037069

(51) **LOC (13) Cl.** **14-03**

(52) **U.S. Cl.**
USPC **D14/248**

(58) **Field of Classification Search**
USPC D14/138 G, 248, 138 C, 138 AB, 341,
D14/439, 432, 345, 138 R, 138 AA,
D14/138 AC, 138 AD, 371, 374
CPC H04M 1/0202; H04M 1/0235; H04M
1/0237; H04M 1/0239; H04M 1/0266;
H04M 1/0268; H04M 1/027; H04M
1/0295; H04M 1/02; H04M 1/0279;
H04M 1/0283

See application file for complete search history.

(56) **References Cited**

U.S. PATENT DOCUMENTS

D612,830 S * 3/2010 Kim D14/138 G
D622,253 S * 8/2010 Park D14/138 G
D632,665 S * 2/2011 Kim D14/138 G
D717,262 S * 11/2014 Phillips D14/138 G

D791,732 S * 7/2017 Xu D14/138 G
D795,826 S * 8/2017 Yoon D14/138 G
D798,260 S * 9/2017 Seo D14/138 G
D816,633 S * 5/2018 Lee D14/138 G
D823,272 S * 7/2018 Croyle D14/138 G
D824,874 S * 8/2018 You D14/138 G
D828,322 S * 9/2018 Ryu D14/138 G
D830,987 S * 10/2018 Choe D14/138 G
D834,551 S * 11/2018 Ryu D14/138 G
D837,175 S * 1/2019 Ryu D14/138 G

(Continued)

OTHER PUBLICATIONS

LG K42, announced Sep. 21, 2020, [online], [retrieved on Apr. 5, 2022], Retrieved from Internet ,<URL: <http://www.gsmarena.com>>.*

(Continued)

Primary Examiner — Bridget L Eland

(74) *Attorney, Agent, or Firm* — NSIP Law

(57) **CLAIM**

We claim the ornamental design for an electronic device, as shown and described.

DESCRIPTION

FIG. 1 is a front perspective view of an electronic device showing our new design;
FIG. 2 is a front view thereof;
FIG. 3 is a rear view thereof;
FIG. 4 is a left-side view thereof;
FIG. 5 is a right-side view thereof;
FIG. 6 is a top view thereof;
FIG. 7 is a bottom view thereof; and,
FIG. 8 is a rear perspective view thereof.

The evenly dashed broken lines in the figures depict portions of the electronic device which form no part of the claimed design.

The dot-dash broken lines define boundaries of the claimed design and form no part of claimed design.

1 Claim, 8 Drawing Sheets

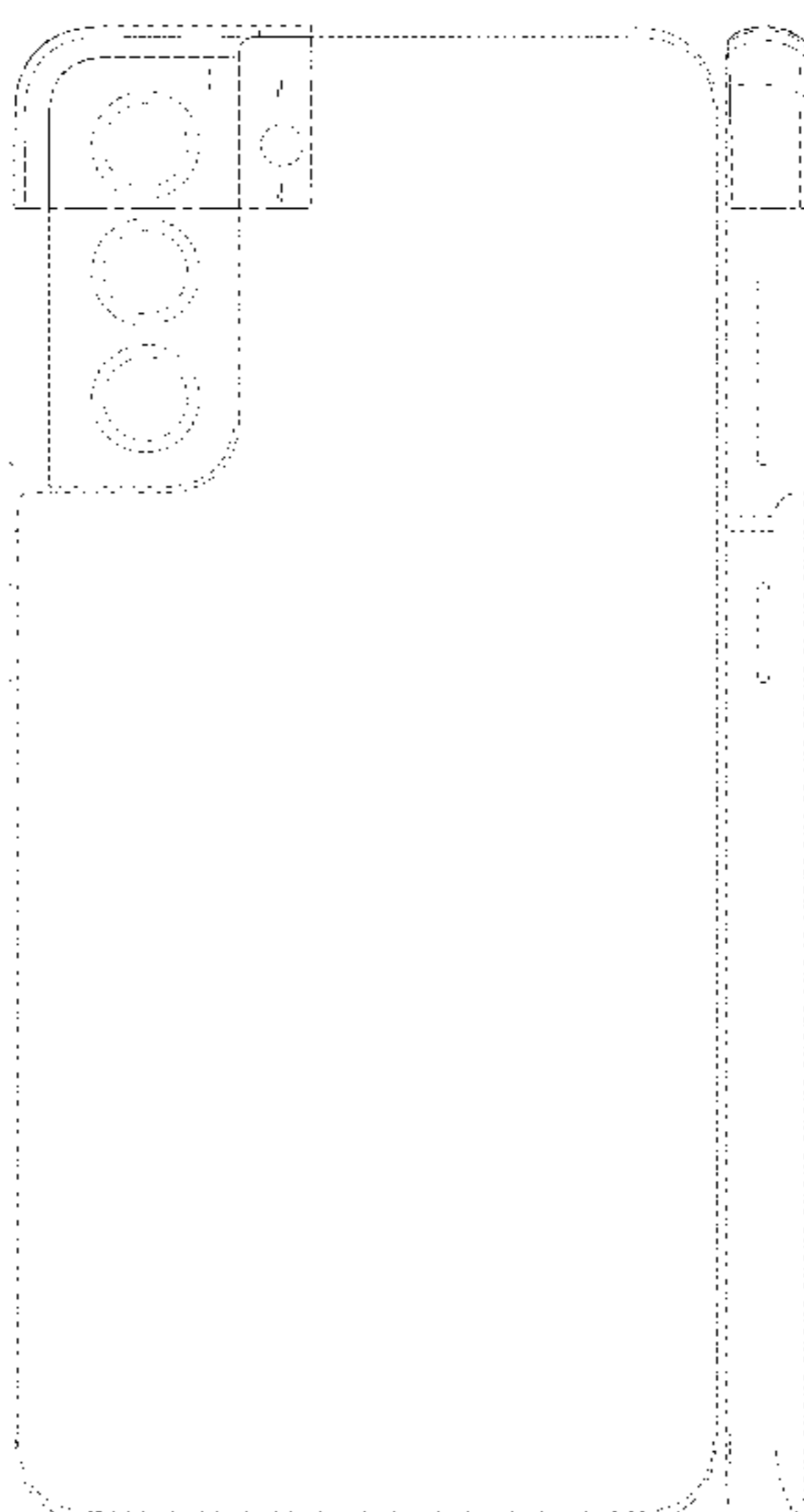

(56)

References Cited

U.S. PATENT DOCUMENTS

D837,176 S * 1/2019 Choi D14/138 G
 D850,402 S * 6/2019 Cho D14/138 G
 D853,980 S * 7/2019 Kim D14/138 G
 D856,296 S * 8/2019 McPhail D14/138 G
 D858,477 S * 9/2019 Andersson D14/138 G
 D860,152 S * 9/2019 Cho D14/138 G
 D860,965 S * 9/2019 Cho D14/138 G
 D864,139 S * 10/2019 Cho D14/138 G
 D865,700 S * 11/2019 Shin D14/138 G
 D866,500 S * 11/2019 Shin D14/138 G
 D867,314 S * 11/2019 Mahonen D14/138 G
 D870,061 S * 12/2019 Mahonen D14/138 G
 D875,060 S * 2/2020 Mahonen D14/138 G
 D877,143 S * 3/2020 Wall D14/341
 D883,946 S * 5/2020 Xu D14/138 G
 D883,947 S * 5/2020 Zhu D14/138 G
 D886,755 S * 6/2020 Park D14/138 G
 D886,757 S * 6/2020 Cho D14/138 G
 D890,153 S * 7/2020 Kim D14/248
 D890,713 S * 7/2020 Xu D14/138 G
 D894,857 S * 9/2020 Cha D14/138 G
 D897,979 S * 10/2020 Choi D14/138 G
 D901,423 S * 11/2020 Qin D14/138 G
 D905,653 S * 12/2020 Park D14/138 G
 10,936,017 B1 * 3/2021 Choi G06F 1/1643

D915,323 S * 4/2021 Kim D14/248
 D915,327 S * 4/2021 Kim D14/138 G
 D915,339 S * 4/2021 Park D14/138 G
 D940,119 S * 1/2022 Kim D14/248
 D940,677 S * 1/2022 Min D14/138 AD
 D940,678 S * 1/2022 Min D14/138 AD
 D940,679 S * 1/2022 Min D14/138 AD
 D940,680 S * 1/2022 Lee D14/138 AD
 D941,793 S * 1/2022 Lee D14/138 G
 2018/0323818 A1 * 11/2018 Hill H04B 1/3888
 2019/0013832 A1 * 1/2019 Mody H04M 1/0202
 2019/0089394 A1 * 3/2019 Mody H04B 1/3888
 2020/0028950 A1 * 1/2020 Mody G06F 1/1626

OTHER PUBLICATIONS

Samsung Galaxy S21 5G, announced Jan. 14, 2021, [online],
 [retrieved on Apr. 5, 2022], Retrieved from Internet ,<URL: <http://www.gsmarena.com>>.*
 Samsung Galaxy S21 Ultra 5G, announced Jan. 14, 2021, [online],
 [retrieved on Apr. 5, 2022], Retrieved from Internet ,<URL: <http://www.gsmarena.com>>.*
 Xiaomi Poco M3 Pro 5G, announced May 19, 2021, [online],
 [retrieved on Apr. 5, 2022], Retrieved from Internet ,<URL: <http://www.gsmarena.com>>.*

* cited by examiner

FIG. 1

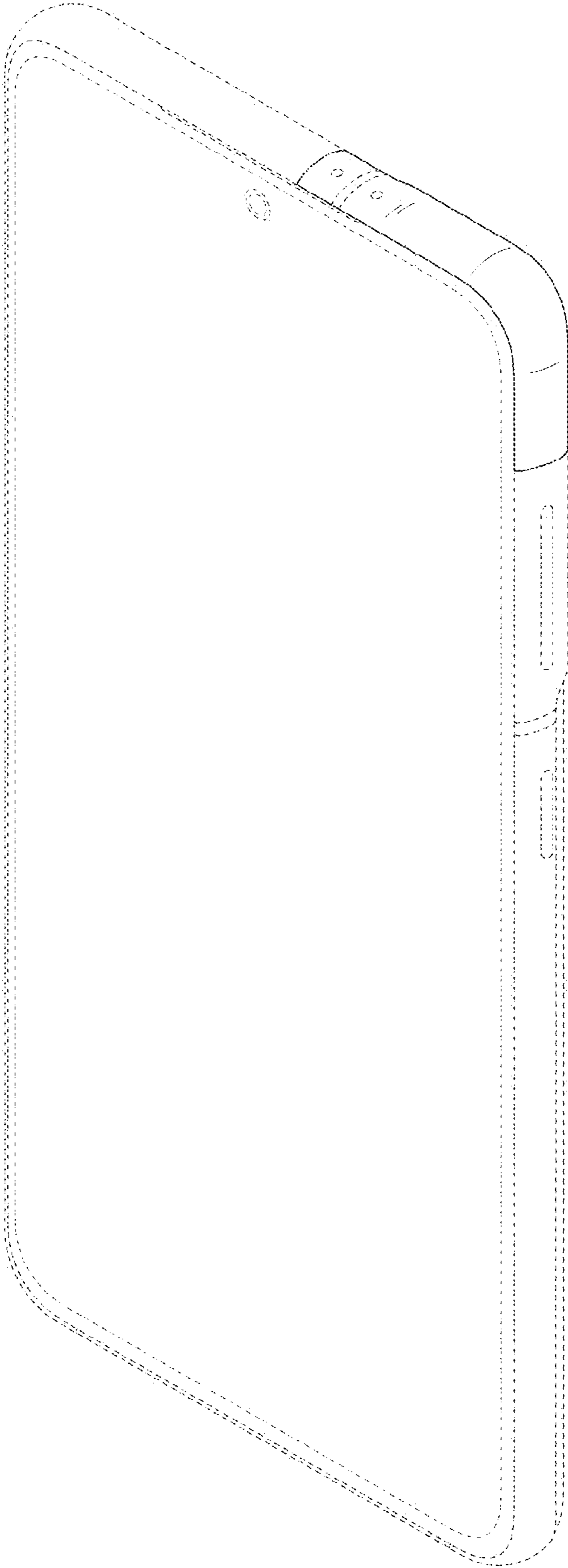

FIG. 2

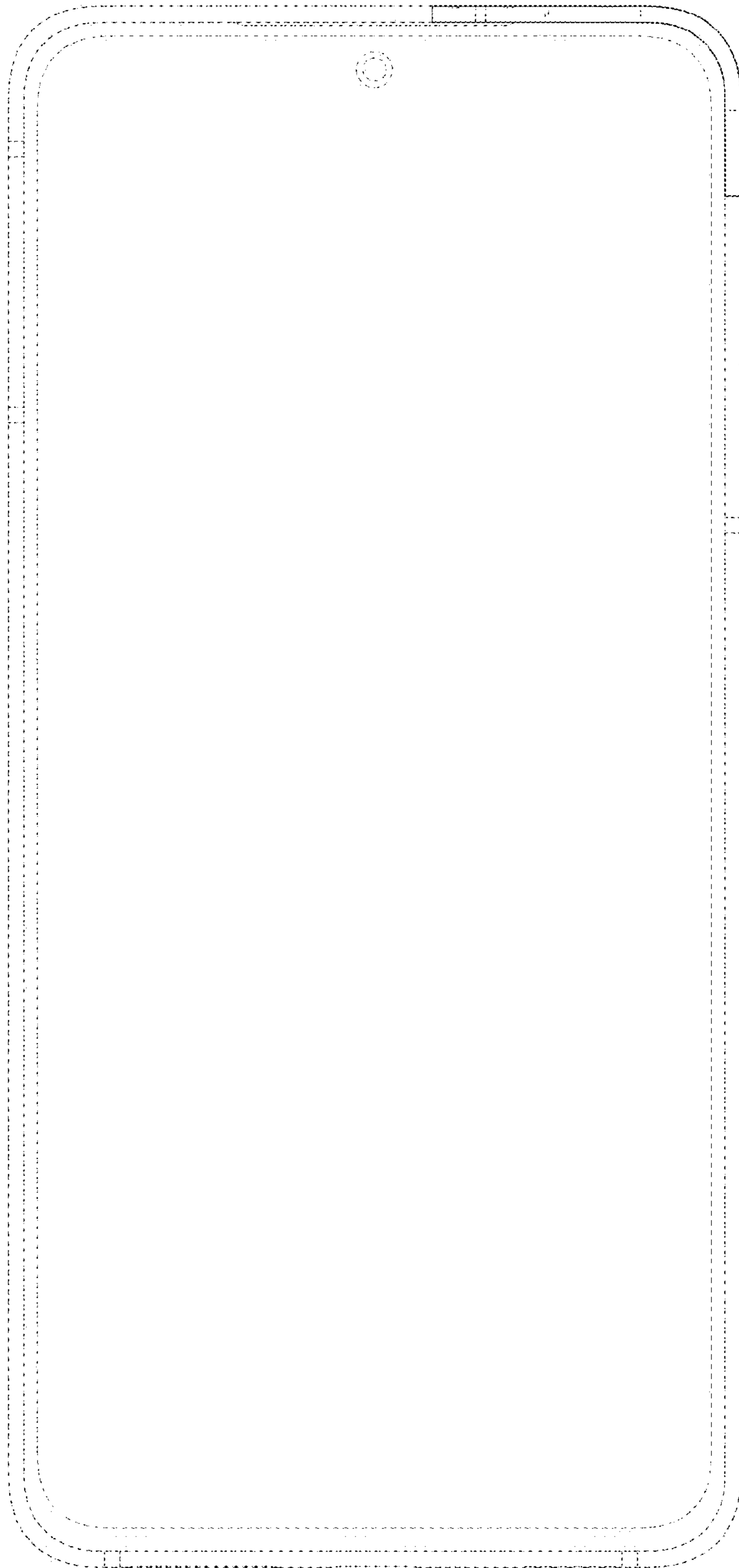

FIG. 3

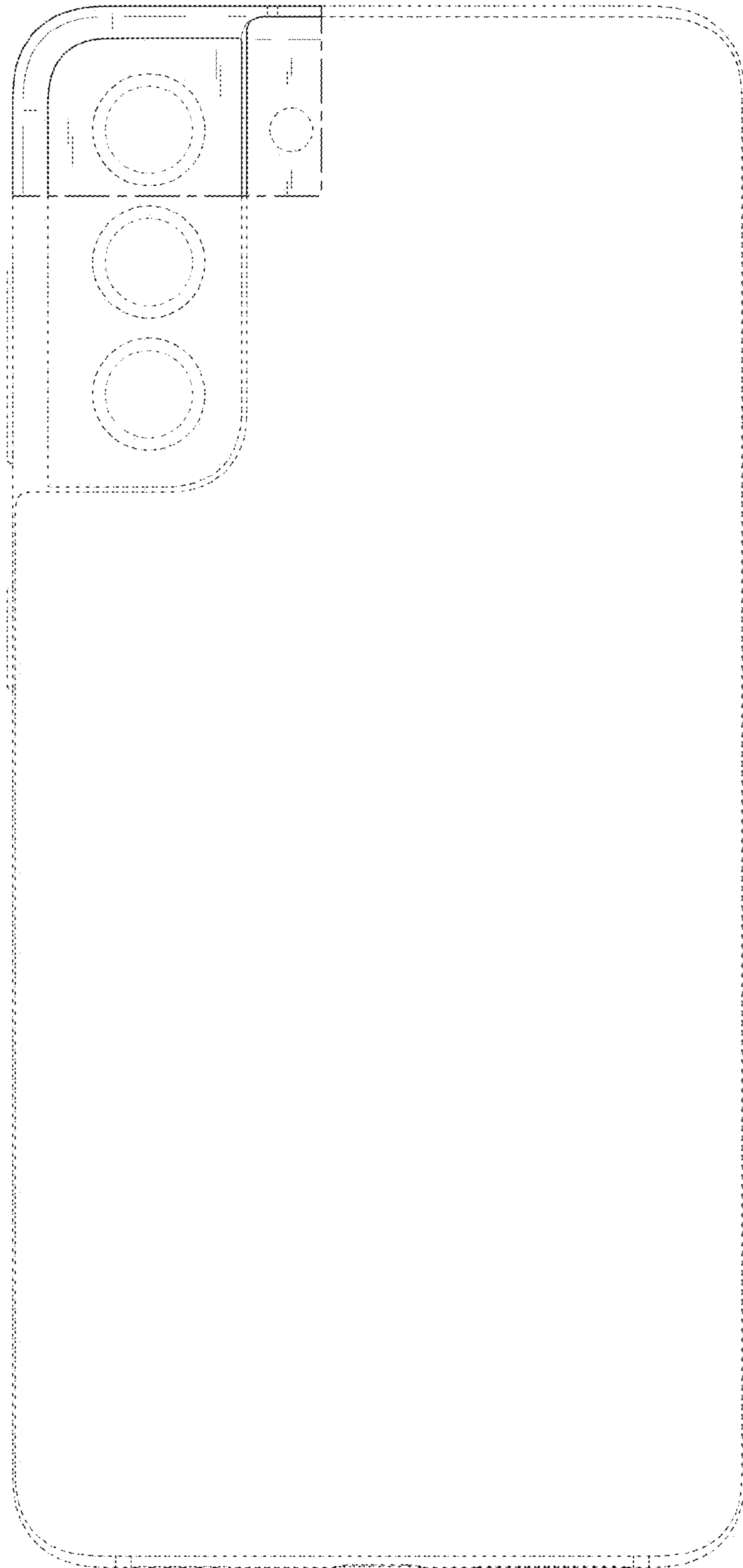

FIG. 4

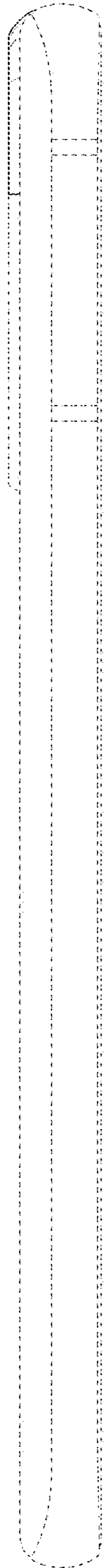

FIG. 5

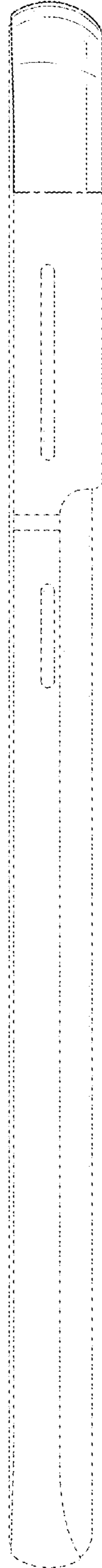

FIG. 6

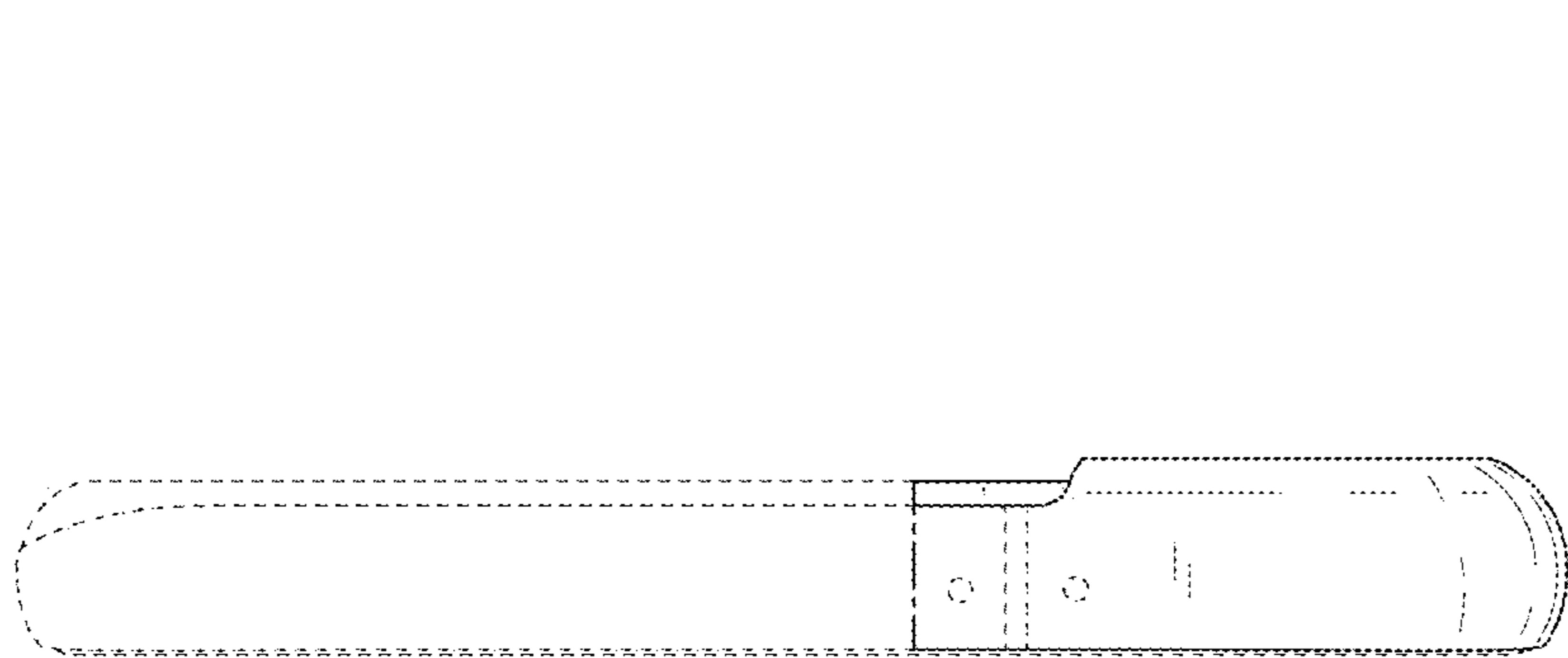

FIG. 7

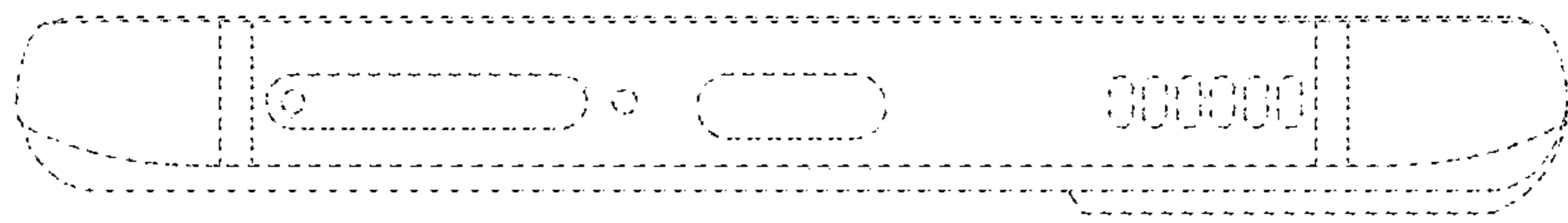

FIG. 8

