



US00D961565S

(12) **United States Design Patent**  
**Kim et al.**

(10) **Patent No.:** **US D961,565 S**  
(45) **Date of Patent:** **\*\* Aug. 23, 2022**

(54) **ELECTRONIC DEVICE**

(71) Applicant: **Samsung Electronics Co., Ltd.**,  
Suwon-si (KR)

(72) Inventors: **Kangmoon Kim**, Suwon-si (KR);  
**Junho Jin**, Suwon-si (KR); **Dahyun Lee**,  
Suwon-si (KR); **Wonkyu Sung**,  
Suwon-si (KR)

(73) Assignee: **SAMSUNG ELECTRONICS CO., LTD.**,  
Suwon-si (KR)

(\*\*) Term: **15 Years**

(21) Appl. No.: **29/725,471**

(22) Filed: **Feb. 25, 2020**

(30) **Foreign Application Priority Data**

Aug. 26, 2019 (KR) ..... 30-2019-0040734

(51) **LOC (13) Cl.** ..... **14-03**

(52) **U.S. Cl.**  
USPC ..... **D14/248**

(58) **Field of Classification Search**  
USPC .... D14/348, 426, 439, 496, 138 R, 138 AA,  
D14/138 AB, 138 AC, 138 AD, 138 C,  
D14/138 G, 203.1, 203.3, 203.4, 203.7,  
D14/299; D10/50  
CPC ..... G06F 3/041; G06F 3/0412; G06F 3/0488;  
G06F 3/04883; G06F 1/1613; G06F  
1/1626; G06F 1/1686; G06F 1/1692;  
G06F 2200/1633; H04M 1/0283; H04M  
1/0279; H04M 1/0202; H04M 1/0266;  
H04M 1/027

See application file for complete search history.

(56) **References Cited**

**U.S. PATENT DOCUMENTS**

D708,609 S \* 7/2014 Lee ..... D14/345  
D899,408 S \* 10/2020 Seo ..... D14/248

D899,409 S \* 10/2020 Seo ..... D14/248  
D902,878 S \* 11/2020 Kim ..... D14/138 AB  
D902,898 S \* 11/2020 Seo ..... D14/248  
D902,899 S \* 11/2020 Seo ..... D14/248

(Continued)

**FOREIGN PATENT DOCUMENTS**

CN 305472693 \* 12/2019  
JP D1643841 \* 10/2019

**OTHER PUBLICATIONS**

Samsung's wildly ambitious \$2,000 folding phone, [www.businessinsider.com](http://www.businessinsider.com), Jul. 25, 2019. <https://www.businessinsider.com/samsung-galaxy-fold-mess-explained-2019-4> (Year: 2019).\*

(Continued)

*Primary Examiner* — Llorellys Martinez

*Assistant Examiner* — Kwabena A. Ankobiah

(74) *Attorney, Agent, or Firm* — McAndrews Held & Malloy, Ltd.

(57) **CLAIM**

The ornamental design for an electronic device, as shown and described.

**DESCRIPTION**

FIG. 1 is a front perspective view of an electronic device showing our new design;  
FIG. 2 is a front elevation view thereof;  
FIG. 3 is a rear elevation view thereof;  
FIG. 4 is a left side elevation view thereof;  
FIG. 5 is a right side elevation view thereof;  
FIG. 6 is a top plan view thereof;  
FIG. 7 is a bottom plan view thereof; and,  
FIG. 8 is a rear perspective view thereof.  
The dashed broken lines in the drawings depict portions of the electronic device that form no part of the claimed design.

**1 Claim, 8 Drawing Sheets**

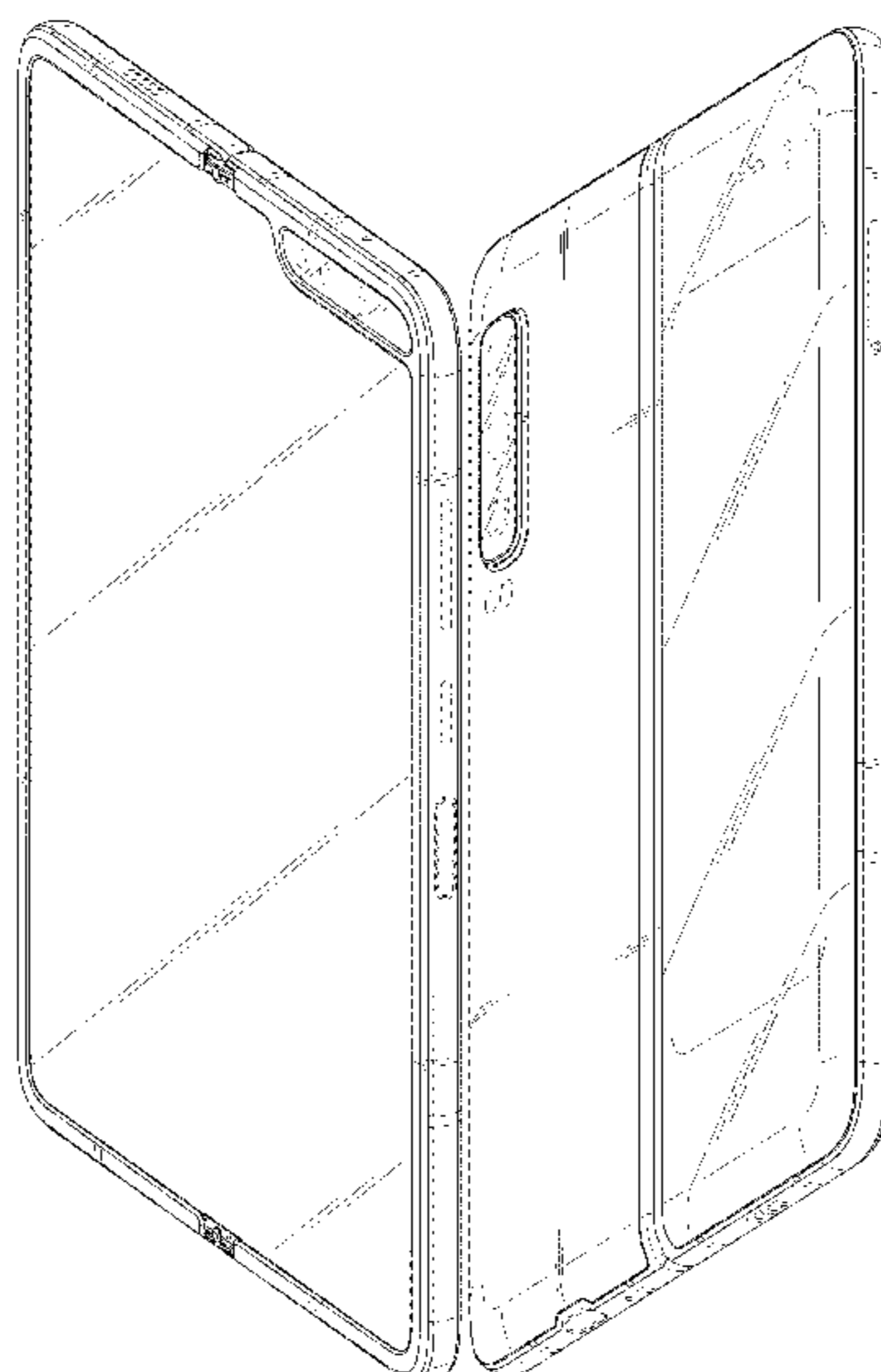

(56)

References Cited

U.S. PATENT DOCUMENTS

D904,367 S \* 12/2020 Seo ..... D14/248  
 D904,368 S \* 12/2020 Seo ..... D14/248  
 D904,369 S \* 12/2020 Seo ..... D14/248  
 D904,370 S \* 12/2020 Seo ..... D14/248  
 D904,371 S \* 12/2020 Seo ..... D14/248  
 D904,372 S \* 12/2020 Seo ..... D14/248  
 D904,379 S \* 12/2020 Seo ..... D14/248  
 D907,614 S \* 1/2021 Kim ..... D14/248  
 D907,615 S \* 1/2021 Kim ..... D14/248  
 D907,616 S \* 1/2021 Kim ..... D14/248  
 10,928,860 B2 \* 2/2021 Park ..... H04M 1/0218  
 D916,067 S \* 4/2021 Seo ..... D14/248  
 D918,885 S \* 5/2021 Kim ..... D14/248  
 D920,301 S \* 5/2021 Seo ..... D14/248  
 D920,302 S \* 5/2021 Seo ..... H04M 1/0268  
 D920,303 S \* 5/2021 Seo ..... D14/248  
 D920,303 S \* 5/2021 Seo ..... H04M 1/02  
 D920,304 S \* 5/2021 Seo ..... G06F 1/1652  
 D920,305 S \* 5/2021 Seo ..... H04M 1/0268  
 D920,306 S \* 5/2021 Seo ..... G06F 1/1647  
 D920,307 S \* 5/2021 Seo ..... H04M 1/0268  
 D920,308 S \* 5/2021 Seo ..... G06F 1/1656  
 D920,309 S \* 5/2021 Seo ..... G06F 1/1643  
 D920,310 S \* 5/2021 Seo ..... D14/248  
 D920,311 S \* 5/2021 Seo ..... D14/248  
 D920,312 S \* 5/2021 Seo ..... D14/248  
 D926,169 S \* 7/2021 Seo ..... G06F 1/1641  
 11,151,917 B1 \* 10/2021 Kim ..... G06F 1/1624  
 11,153,421 B2 \* 10/2021 Kang ..... G06F 1/1652  
 11,169,566 B2 \* 11/2021 Kim ..... G06F 1/3215  
 11,184,980 B2 \* 11/2021 An ..... H05K 5/0004  
 11,191,195 B2 \* 11/2021 Baek ..... H04M 1/0216  
 11,221,676 B2 \* 1/2022 Song ..... G06F 3/0346  
 11,228,669 B2 \* 1/2022 Jang ..... G06F 1/1616  
 D948,515 S \* 4/2022 Jeon ..... D14/440  
 11,314,284 B2 \* 4/2022 Kim ..... G06F 1/1652  
 D951,896 S \* 5/2022 Kim ..... D14/138 AB  
 2020/0012324 A1 \* 1/2020 Sung ..... G06F 1/1652  
 2020/0177714 A1 \* 6/2020 Jung ..... H04M 1/0268  
 2020/0264657 A1 \* 8/2020 Lee ..... G06F 3/04883  
 2020/0264826 A1 \* 8/2020 Kwon ..... G06F 3/04883  
 2021/0018957 A1 \* 1/2021 Cho ..... G06F 1/1641  
 2021/0074242 A1 \* 3/2021 Cho ..... G06F 3/1446  
 2021/0089079 A1 \* 3/2021 Kang ..... A61B 5/6898  
 2021/0092855 A1 \* 3/2021 Choi ..... H04M 1/0268  
 2021/0116964 A1 \* 4/2021 Moon ..... H05K 5/0226  
 2021/0120207 A1 \* 4/2021 Lee ..... G06F 1/1652  
 2021/0126992 A1 \* 4/2021 Jung ..... H04M 1/0214  
 2021/0152678 A1 \* 5/2021 Jang ..... G06F 1/1652

2021/0185164 A1 \* 6/2021 Jung ..... H04M 1/72454  
 2021/0191460 A1 \* 6/2021 Lee ..... G06F 1/1652  
 2021/0191466 A1 \* 6/2021 Park ..... G06F 1/1641  
 2021/0192984 A1 \* 6/2021 Yoo ..... H04M 1/0268  
 2021/0210510 A1 \* 7/2021 Hsieh ..... H04M 1/02  
 2021/0240232 A1 \* 8/2021 Cheng ..... G06F 1/1652  
 2021/0255666 A1 \* 8/2021 Kim ..... H04M 1/0268  
 2021/0271335 A1 \* 9/2021 Kishimoto ..... G06F 1/1647  
 2021/0377372 A1 \* 12/2021 Jung ..... H04M 1/0268  
 2021/0397221 A1 \* 12/2021 Hwang ..... G06F 1/1643  
 2021/0398465 A1 \* 12/2021 Kim ..... G06F 3/0483  
 2021/0405706 A1 \* 12/2021 Min ..... G06F 1/1656  
 2022/0043481 A1 \* 2/2022 Shin ..... G06F 3/0412  
 2022/0044655 A1 \* 2/2022 Cho ..... G06F 1/1616  
 2022/0148474 A1 \* 5/2022 Kwon ..... G09G 3/035  
 2022/0155889 A1 \* 5/2022 Choi ..... G06F 1/1643

OTHER PUBLICATIONS

Unboxing The \$2,000 Samsung Galaxy Fold, www.youtube.com, Apr. 16, 2019. <https://www.youtube.com/watch?v=H7Gv8zxTHtw&t=59s> (Year: 2019).\*

Samsung Galaxy Fold review:, www.youtube.com, Apr. 19, 2019. <https://www.youtube.com/watch?v=e7WpRzSnNAU> (Year: 2019).\*

Galaxy Fold, www.theguardian.com, Apr. 18, 2019. <https://www.theguardian.com/technology/2019/apr/18/galaxy-fold-samsung-investigates-as-screens-break-in-first-days> (Year: 2019).\*

My Samsung Galaxy Fold, www.theverge.com, Apr. 17, 2019. <https://www.theverge.com/2019/4/17/18411510/samsung-galaxy-fold-broken-screen-debris-dust-hinge-flexible-bulge> (Year: 2019).\*

Samsung Galaxy Fold 5G, www.notebookcheck.net, Oct. 9, 2019. <https://www.notebookcheck.net/Samsung-Galaxy-Fold-5G-Smartphone-Review-A-foldable-handset-with-an-air-of-confidence.437588.0.html> (Year: 2019).\*

New Galaxy Fold 2, www.notebookcheck.net, Apr. 7, 2020. <https://www.notebookcheck.net/New-Galaxy-Fold-2-and-Galaxy-Z-Flip-5G-details-get-leaked.460098.0.html> (Year: 2020).\*

Samsung Unpacked, www.cnet.com, Aug. 4, 2020. <https://www.cnet.com/tech/mobile/samsung-unpacked-is-today-galaxy-z-fold-2-rumors-cameras-preorder-dates-and-more/> (Year: 2020).\*

First Galaxy Z Fold 2, www.androidheadlines.com, Feb. 18, 2020. <https://www.androidheadlines.com/2020/02/first-galaxy-z-fold-2-concept-stunning.html> (Year: 2020).\*

Xiaomi patents a foldable smartphone, www.twitter.com, Nov. 23, 2020. [https://mobile.twitter.com/tech\\_edgete/status/1330809158849814531](https://mobile.twitter.com/tech_edgete/status/1330809158849814531) (Year: 2020).\*

Huawei Mate X2 design revealed, www.mspoweruser.com, Sep. 25, 2020. <https://mspoweruser.com/huawei-mate-x2-design-revealed/> (Year: 2020).\*

Samsung Unfolds the Future with a Whole New Mobile Category: Introducing Galaxy Fold, www.news.samsung.com/, Feb. 20, 2019. <https://news.samsung.com/us/samsung-unfolds-galaxy-fold-unpacked-2019/> (Year: 2019).\*

\* cited by examiner

FIG. 1

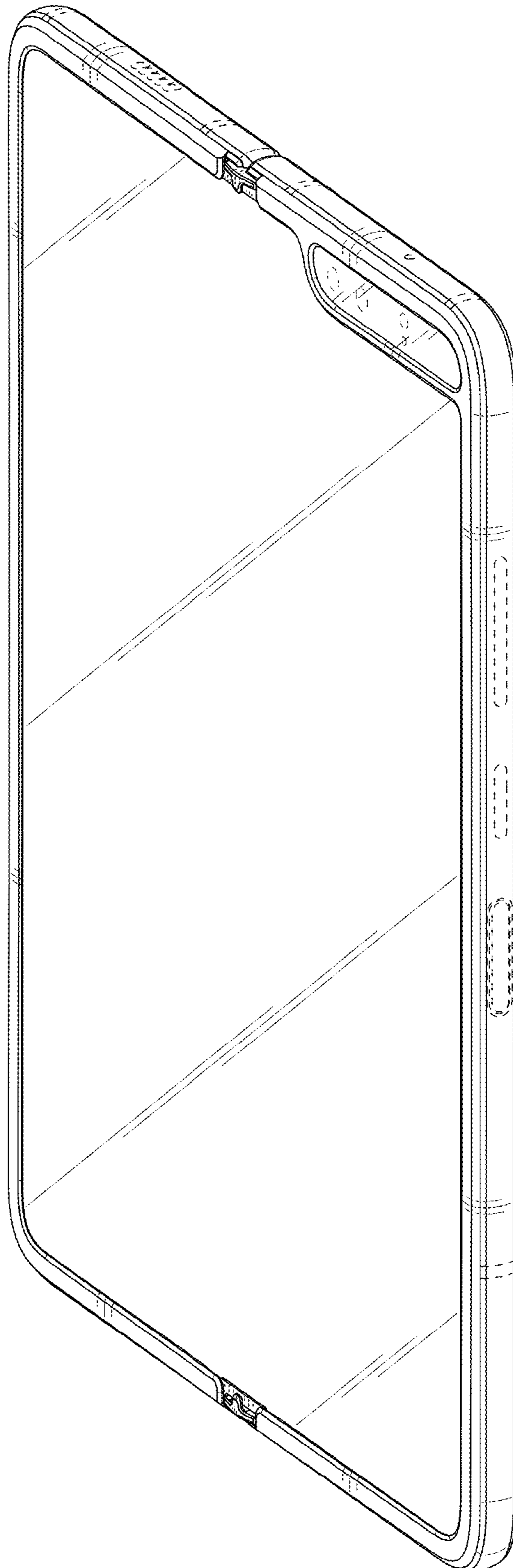

FIG. 2

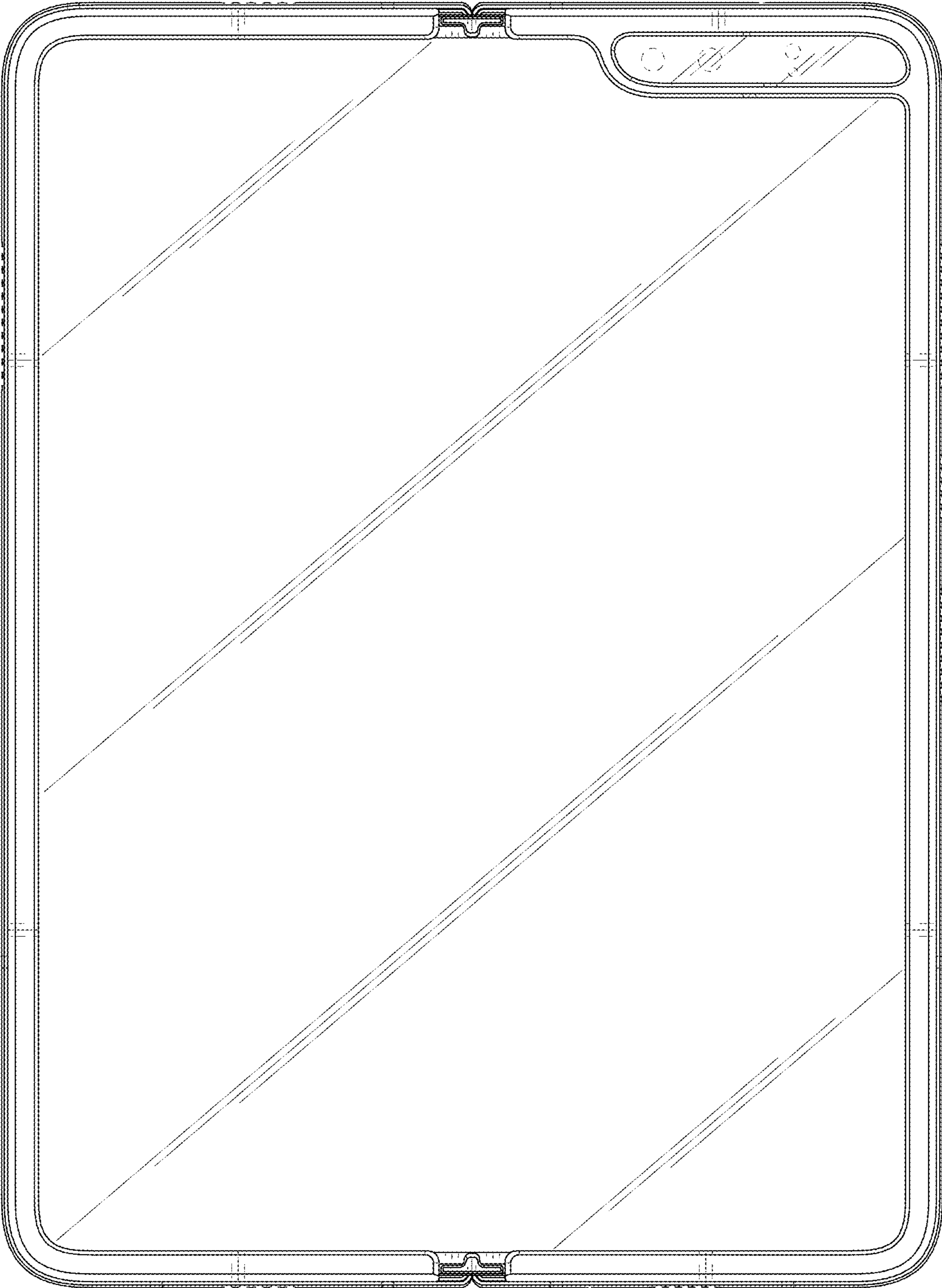

FIG. 3

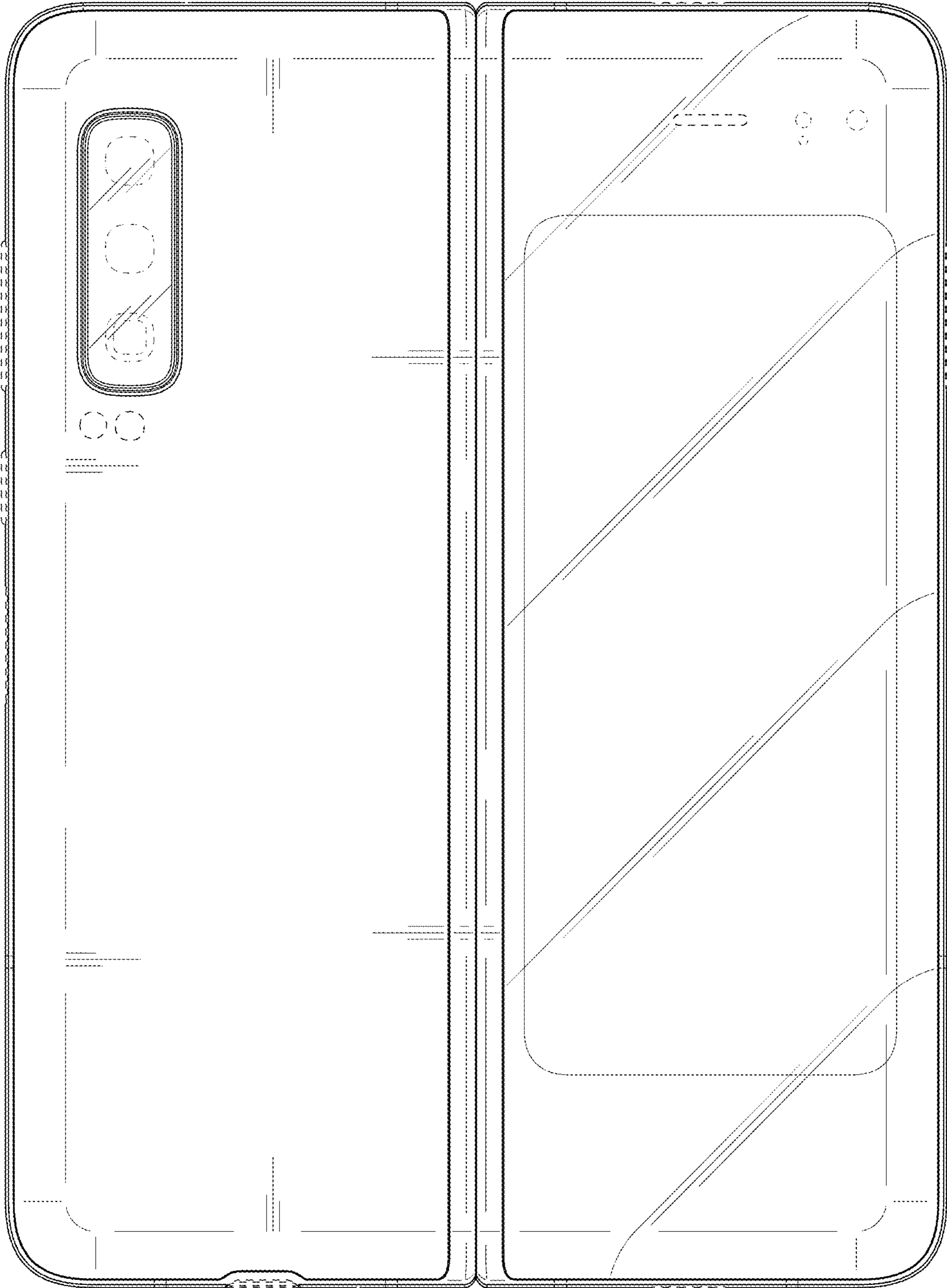

FIG. 4

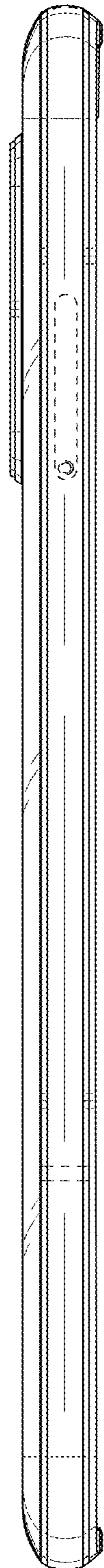

FIG. 5

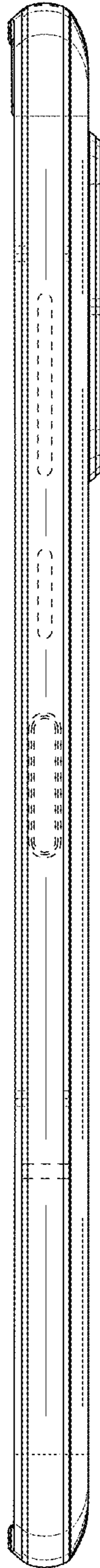

FIG. 6

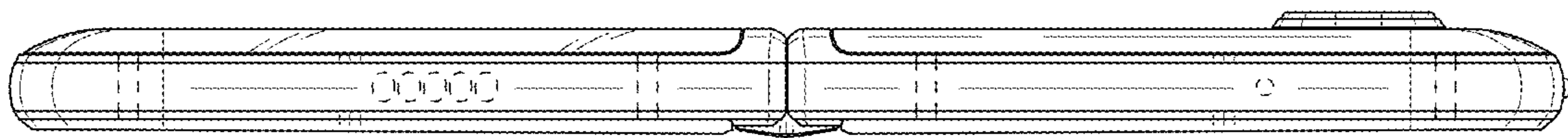



FIG. 7

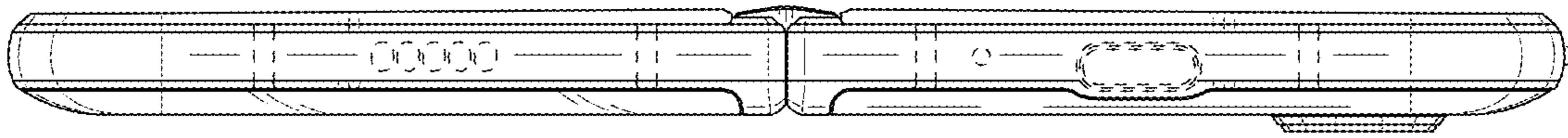

FIG. 8

