



US00D961517S

(12) **United States Design Patent**  
**Kanda et al.**

(10) **Patent No.:** **US D961,517 S**

(45) **Date of Patent:** **\*\* Aug. 23, 2022**

(54) **BATTERY MODULE CASE**

(71) Applicant: **DENSO CORPORATION**, Kariya (JP)

(72) Inventors: **Yuko Kanda**, Kariya (JP); **Yuji Kawahara**, Kariya (JP)

(73) Assignee: **DENSO CORPORATION**, Kariya (JP)

(\*\*) Term: **15 Years**

(21) Appl. No.: **29/718,306**

(22) Filed: **Dec. 23, 2019**

(30) **Foreign Application Priority Data**

Jul. 19, 2019 (JP) ..... 2019-016294

(51) **LOC (13) Cl.** ..... **13-02**

(52) **U.S. Cl.**  
USPC ..... **D13/119**

(58) **Field of Classification Search**

USPC ..... D13/102, 103, 110, 118–121, 184, 199;  
D3/274, 302; D14/250

CPC .... H01M 50/10; H01M 50/107; H01M 50/20;  
H01M 50/557; H01M 50/209; H01M  
50/213; H01M 50/502; H01M 50/103;  
H01M 50/204

See application file for complete search history.

(56) **References Cited**

**U.S. PATENT DOCUMENTS**

D401,550 S	*	11/1998	Chambers	.....	D13/103
D489,683 S	*	5/2004	Johnson	.....	D13/119
D490,054 S	*	5/2004	Johnson	.....	D13/119
D490,055 S	*	5/2004	Johnson	.....	D13/119
D490,056 S	*	5/2004	Johnson	.....	D13/119
D556,681 S	*	12/2007	Kim	.....	D3/218

(Continued)

*Primary Examiner* — Rosemary K Tarcza

(74) *Attorney, Agent, or Firm* — Oliff PLC

(57) **CLAIM**

The ornamental design for a battery module case, as shown and described.

**DESCRIPTION**

FIG. 1 is a front elevational view of the battery module case; FIG. 2 is a rear elevational view thereof; FIG. 3 is a left-side elevational view thereof; FIG. 4 is a right-side elevational view thereof; FIG. 5 is a top plan view thereof; FIG. 6 is a bottom plan view thereof; FIG. 7 is a top, front perspective view thereof; FIG. 8 is a top, rear perspective view thereof; FIG. 9 is a top, left perspective view thereof; FIG. 10 is a top, right perspective view thereof; FIG. 11 is a cross-sectional view along line 11-11 in FIG. 1; FIG. 12 is a cross-sectional view along line 12-12 in FIG. 1; FIG. 13 is a detail view of the area demarcated by line 13 in FIG. 11; FIG. 14 is a detail view of the area demarcated by line 14 in FIG. 11; FIG. 15 is a detail view of the area demarcated by line 15 in FIG. 12; FIG. 16 is a detail view of the area demarcated by line 16 in FIG. 12; FIG. 17 is a detail view of the area demarcated by line 17 in FIG. 9; FIG. 18 is a detail view of the area demarcated by line 18 in FIG. 9; FIG. 19 is a detail view of the area demarcated by line 19 in FIG. 10; and, FIG. 20 is a detail view of the area demarcated by line 20 in FIG. 10.

The evenly spaced broken lines indicate the cross-sectional lines and the detail view lines, and form no part of the claimed design.

**1 Claim, 13 Drawing Sheets**

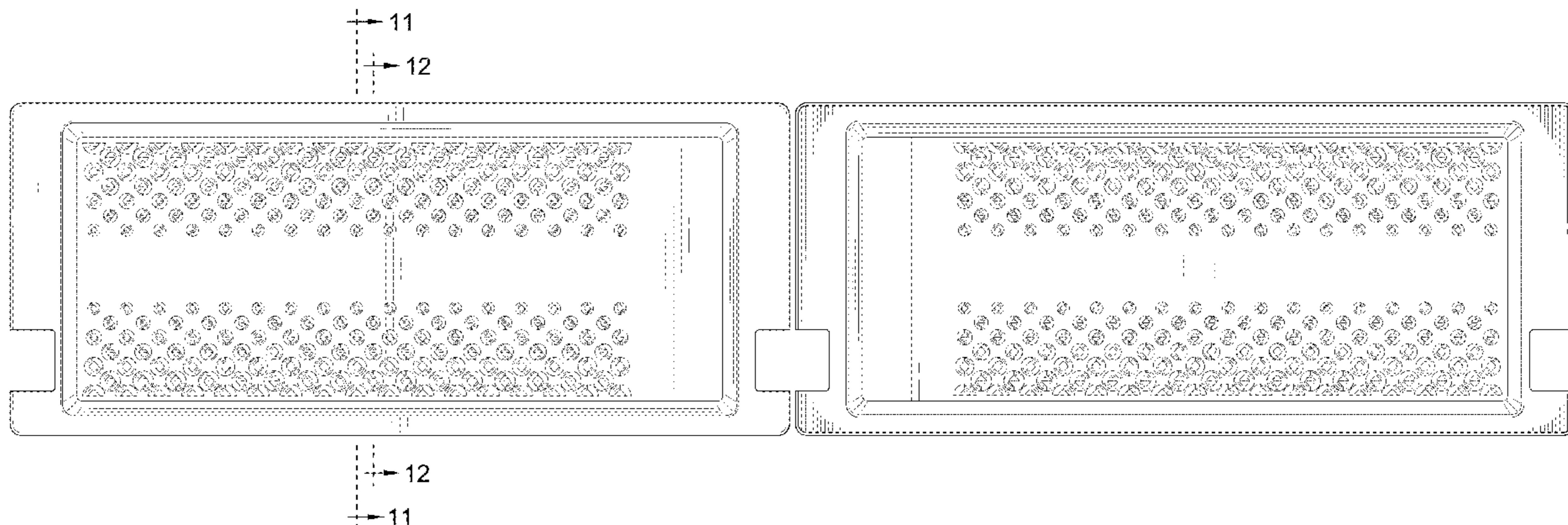

(56)

**References Cited**

U.S. PATENT DOCUMENTS

D616,361 S *	5/2010	Huang .....	D13/103
D653,202 S *	1/2012	Hasbrook .....	D13/103
D660,789 S *	5/2012	Mar .....	D13/103
D663,263 S *	7/2012	Gupta .....	D13/103
D666,149 S *	8/2012	Sacks .....	D13/119
D709,439 S *	7/2014	Ferber .....	D13/103
D710,795 S *	8/2014	Gupta .....	D13/103
D728,468 S *	5/2015	Ferber .....	D13/103
D767,485 S *	9/2016	To .....	D13/103
D883,917 S *	5/2020	Chen .....	D13/103
D934,802 S *	11/2021	Kanda .....	D13/119
D934,803 S *	11/2021	Kanda .....	D13/119
2022/0140425 A1 *	5/2022	Lee .....	H01M 50/186 429/185

\* cited by examiner

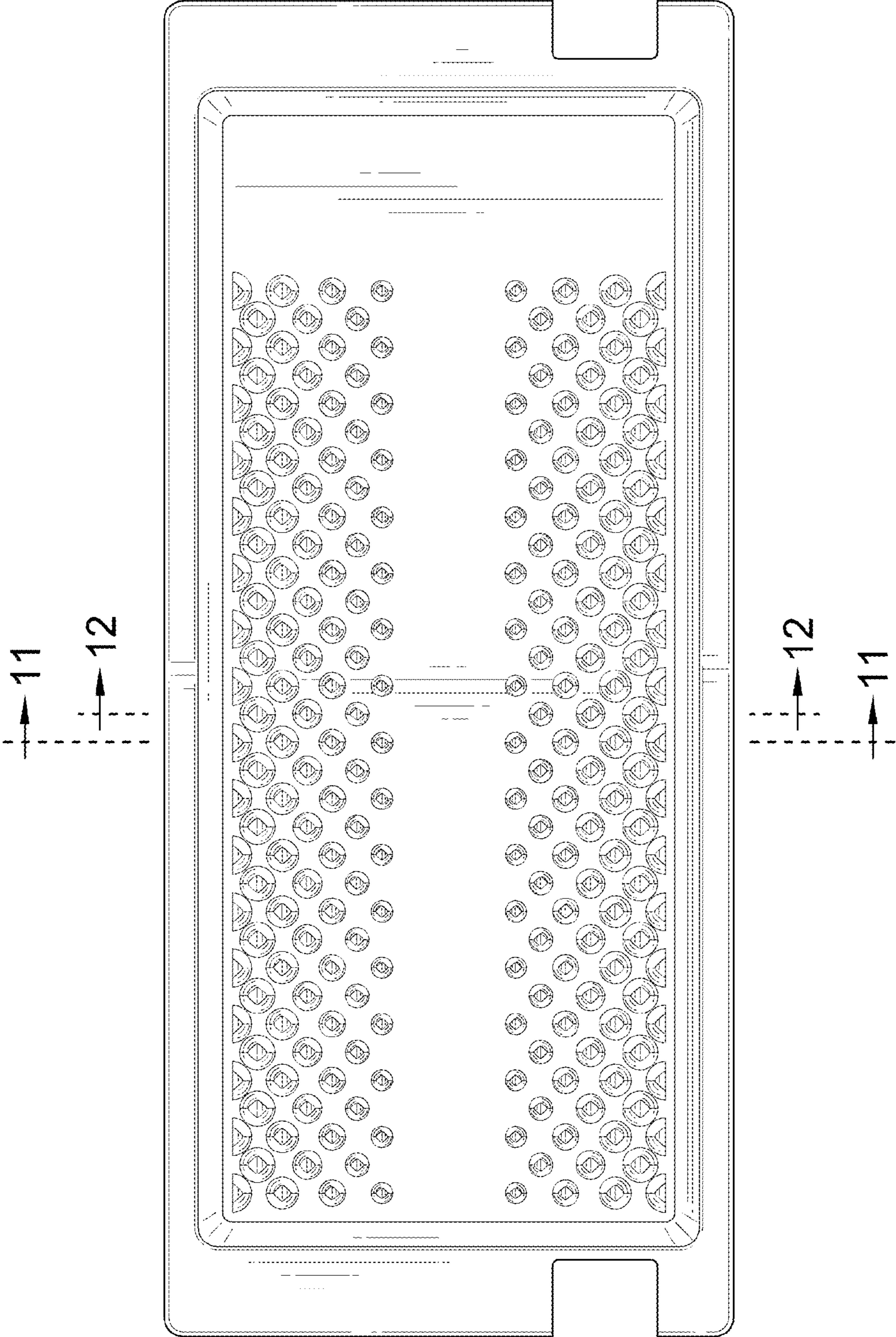

FIG. 1

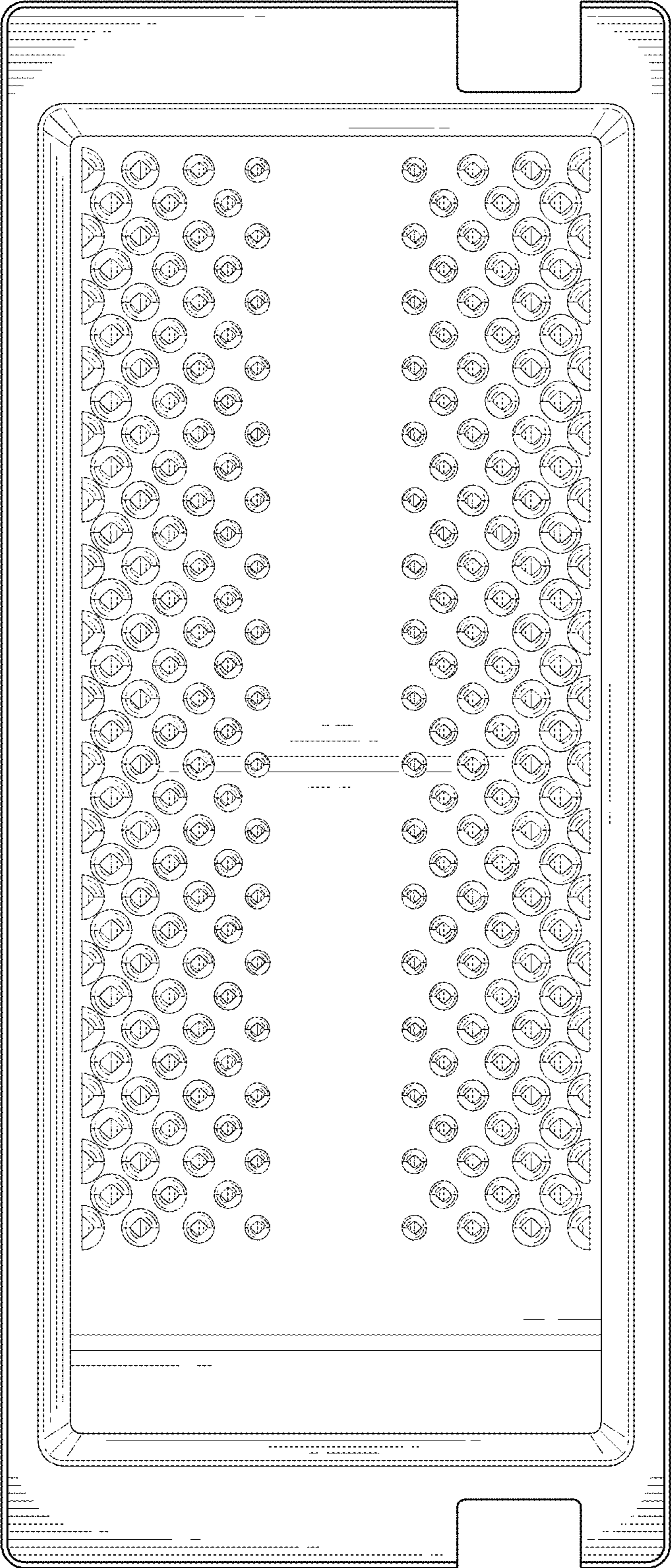

FIG. 2

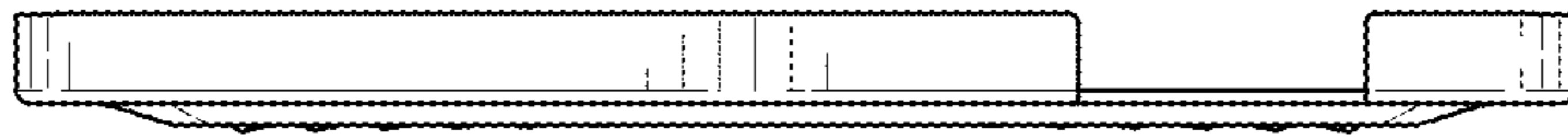

FIG. 4

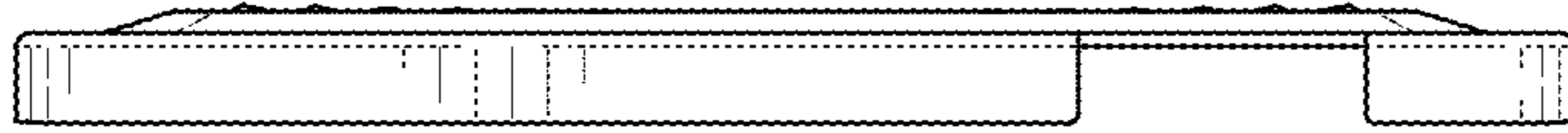

FIG. 3

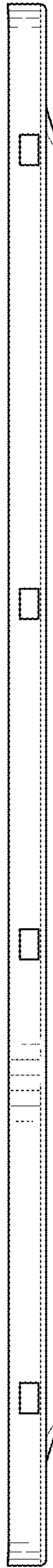

FIG. 5



FIG. 6

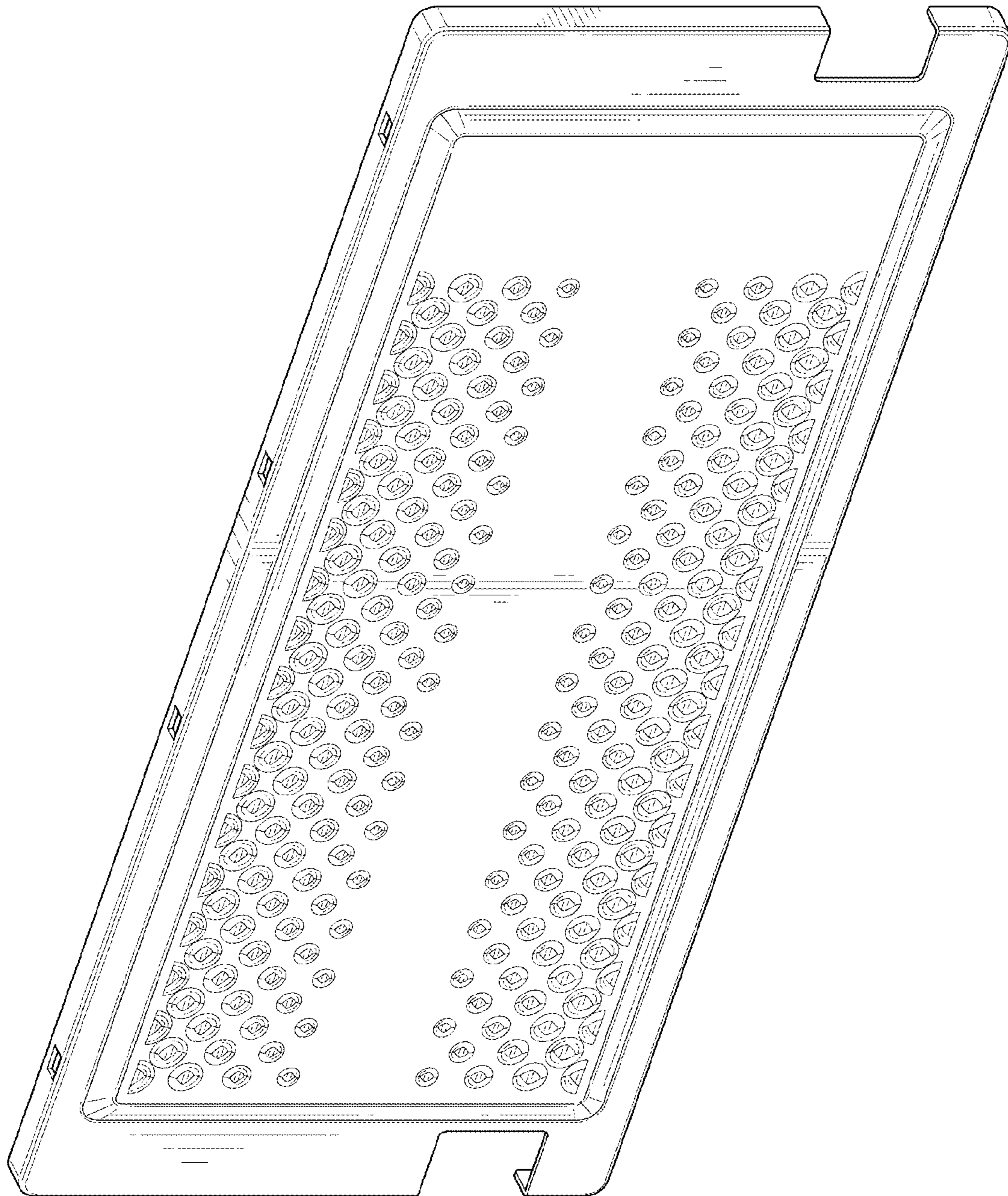

FIG. 7

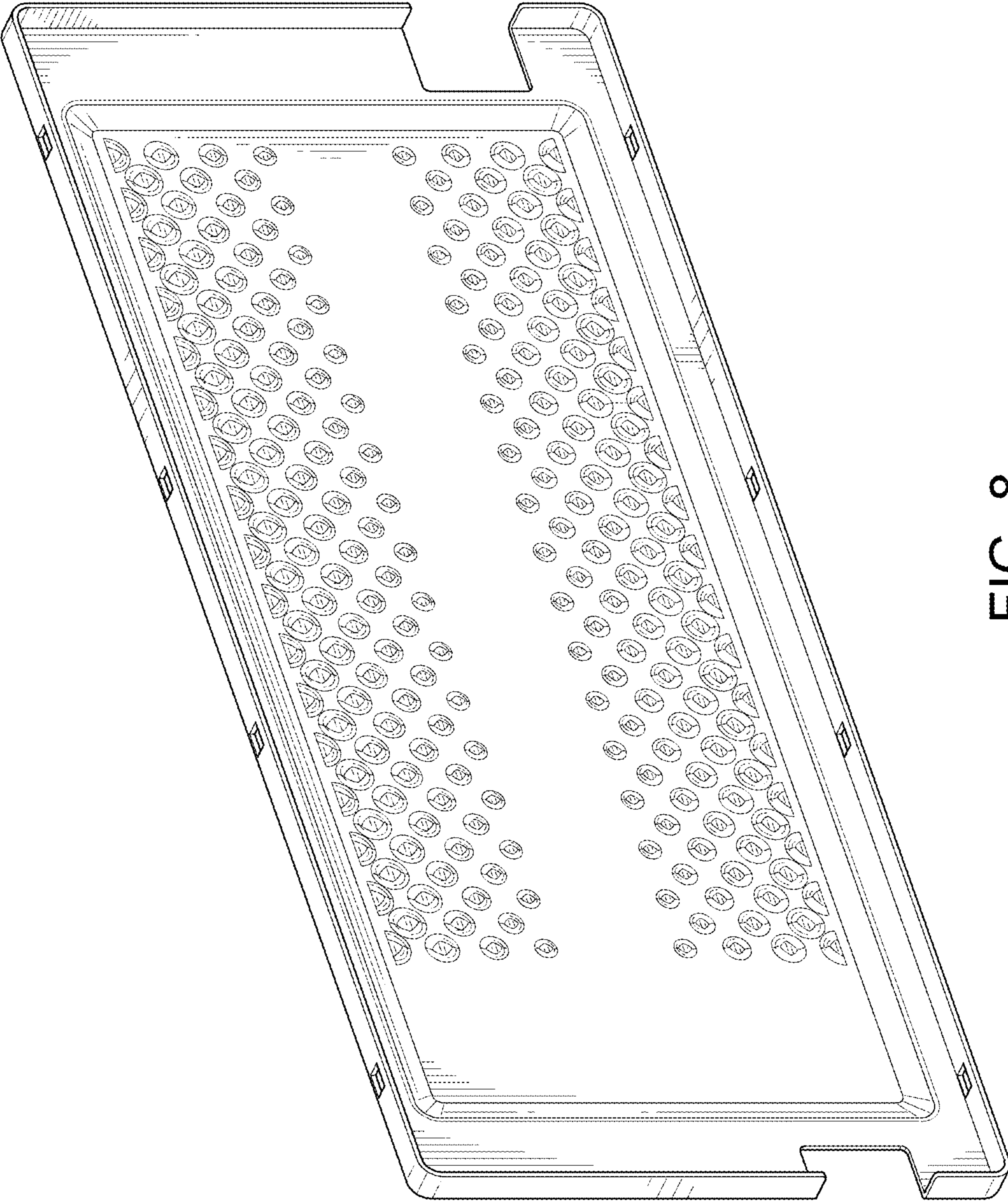

FIG. 8



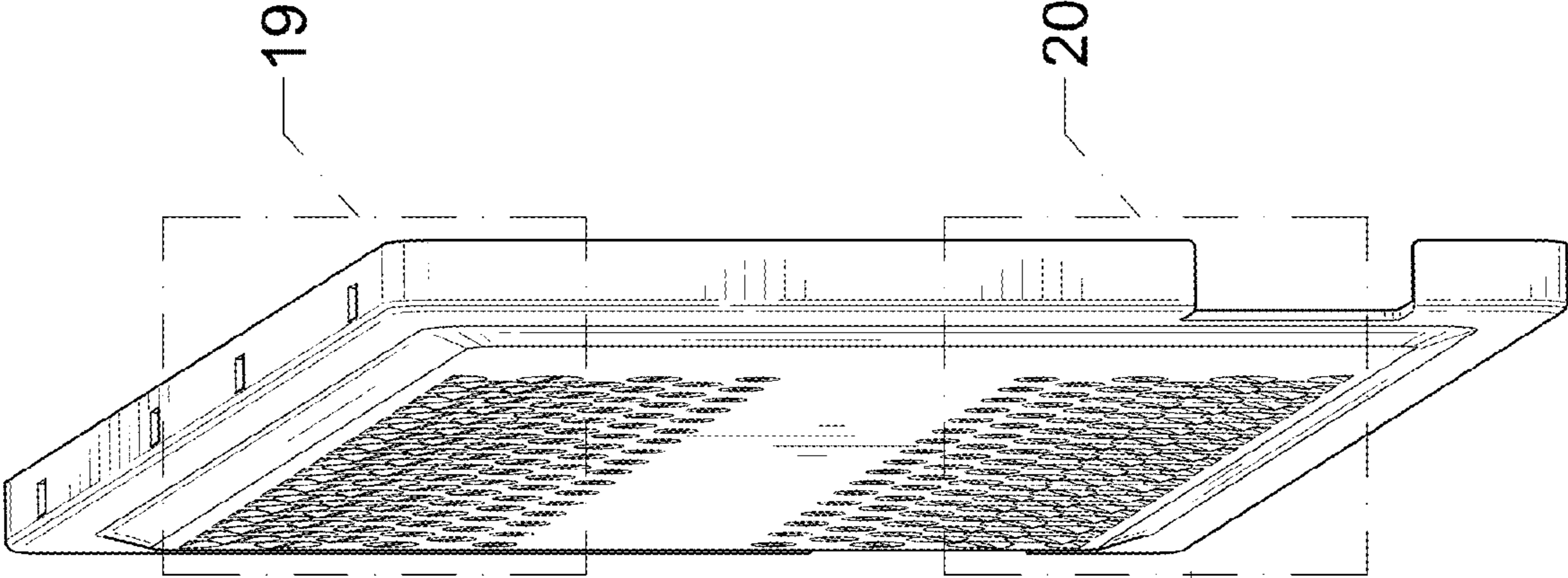

FIG. 10

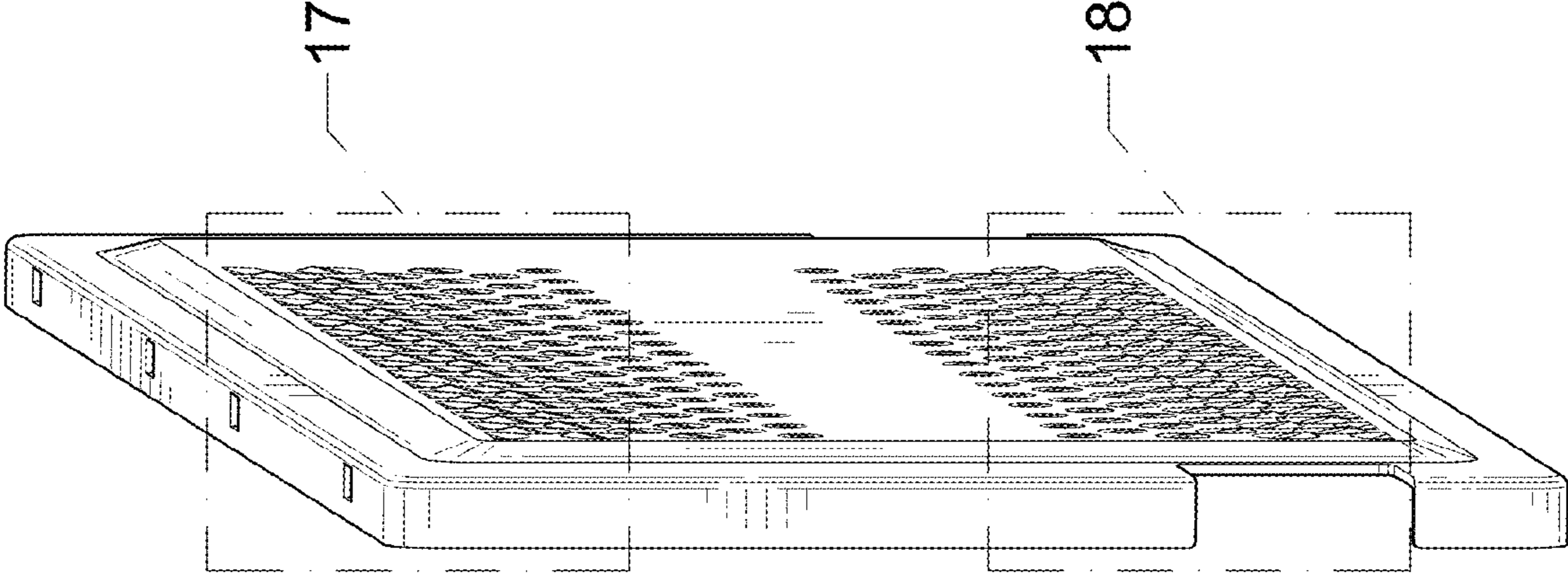

FIG. 9

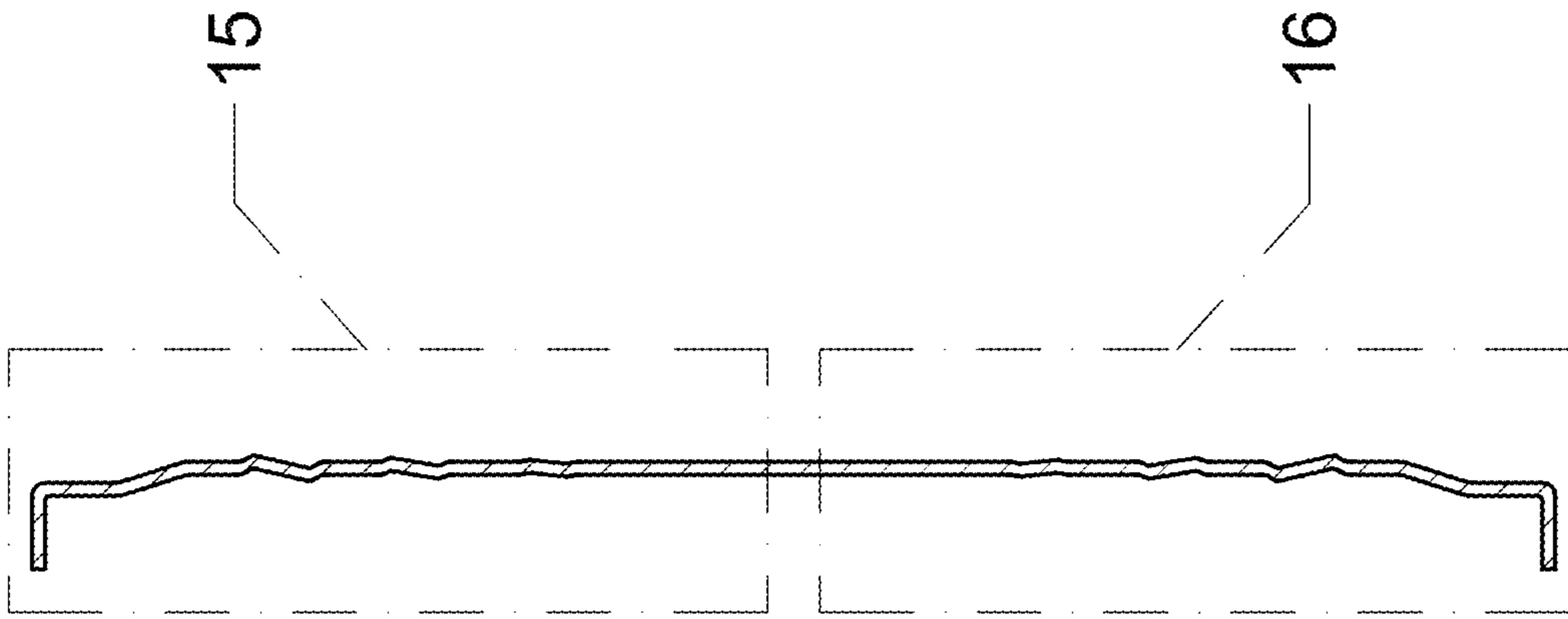

FIG. 11

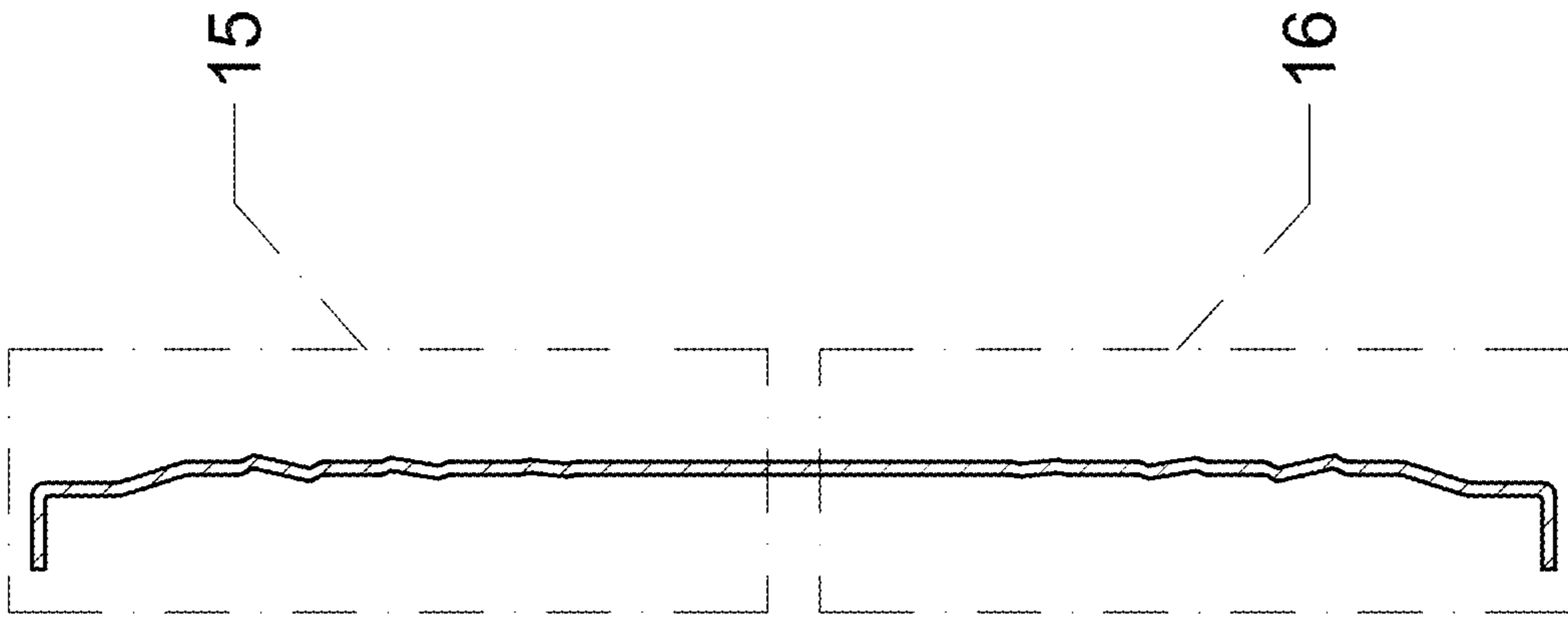

FIG. 12

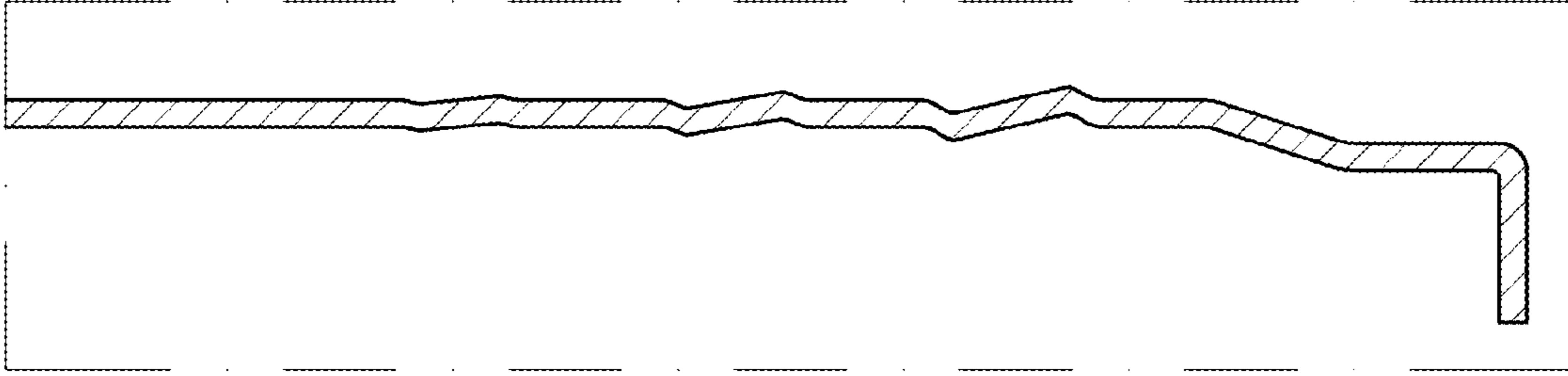

FIG. 16

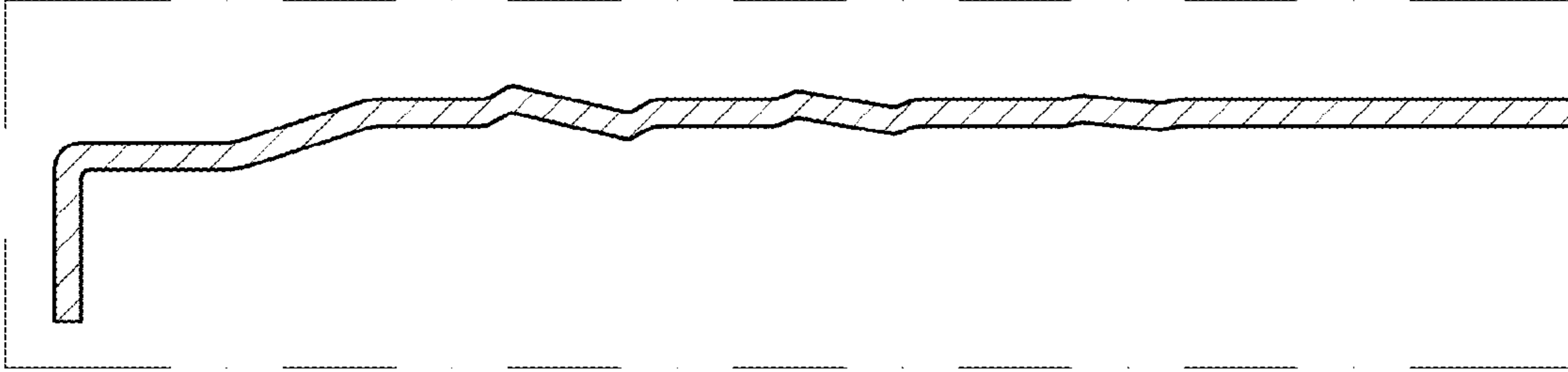

FIG. 15

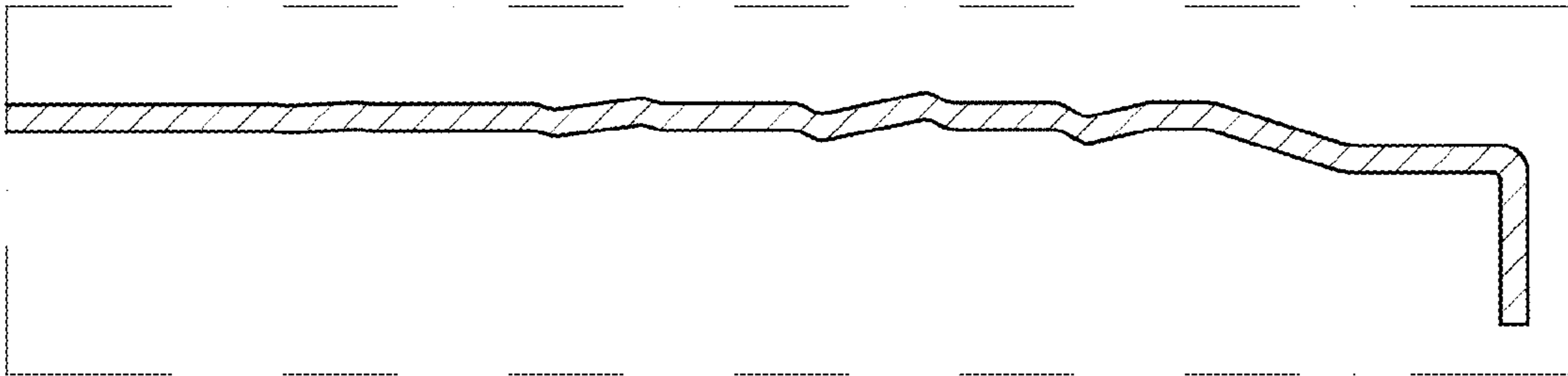

FIG. 14

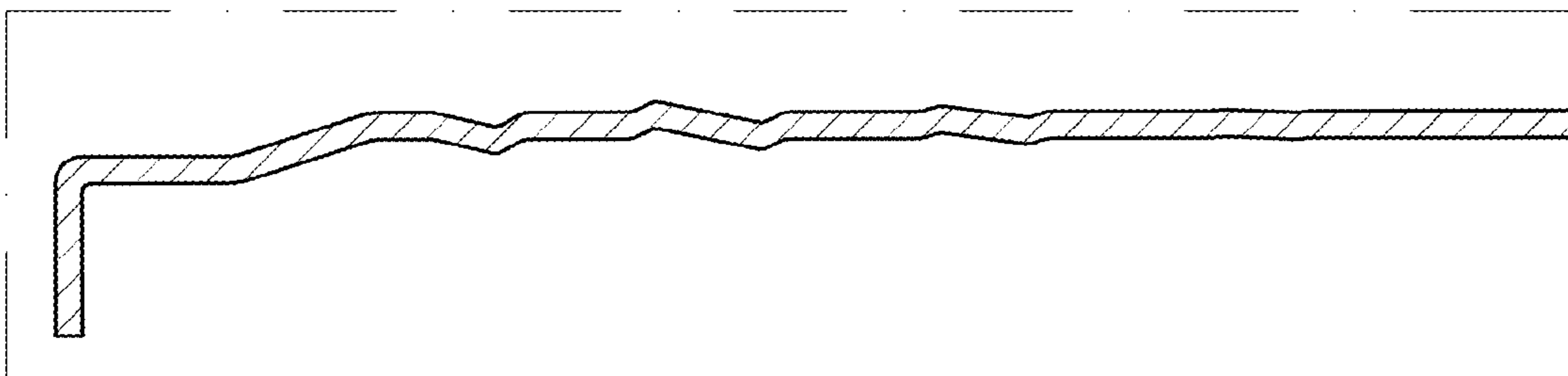

FIG. 13

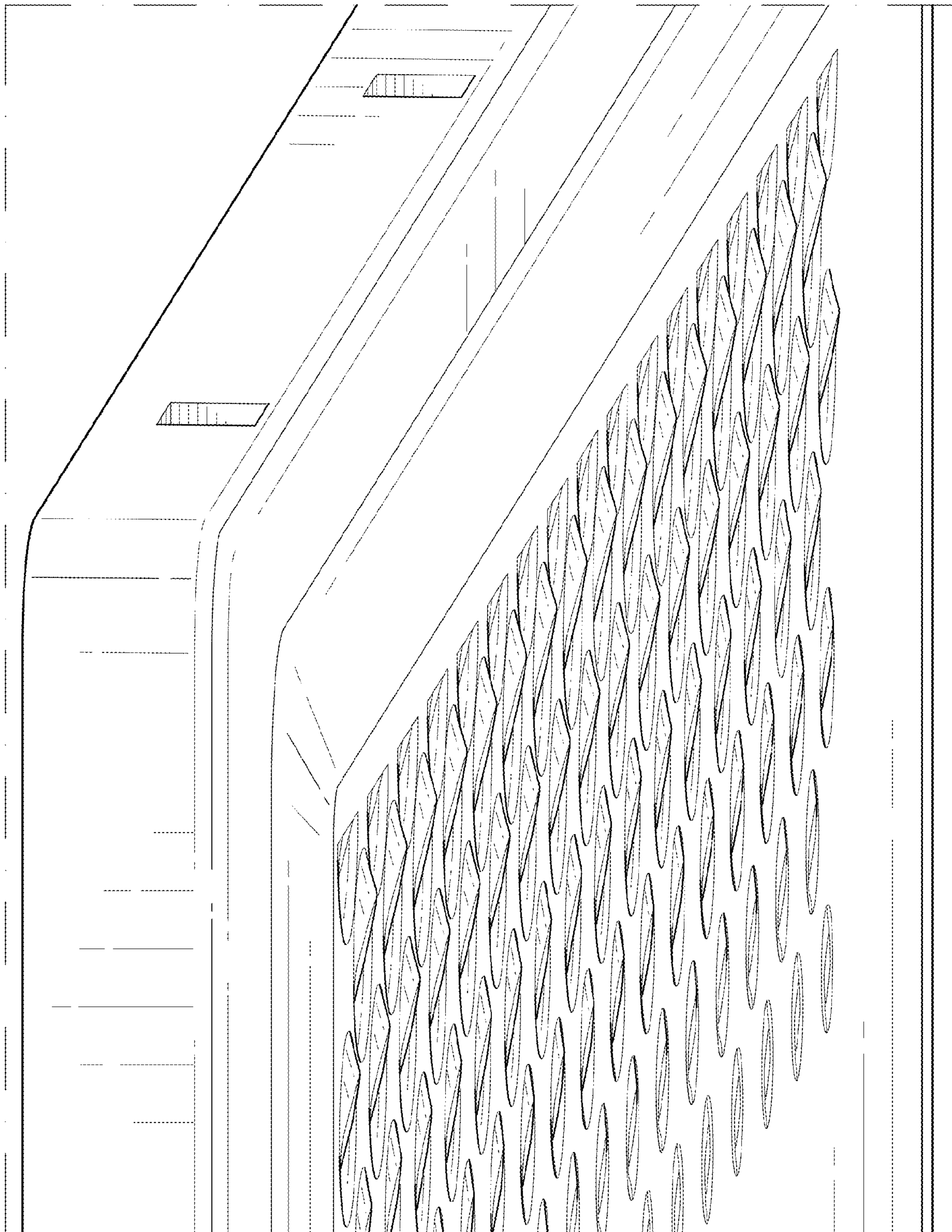

FIG. 17

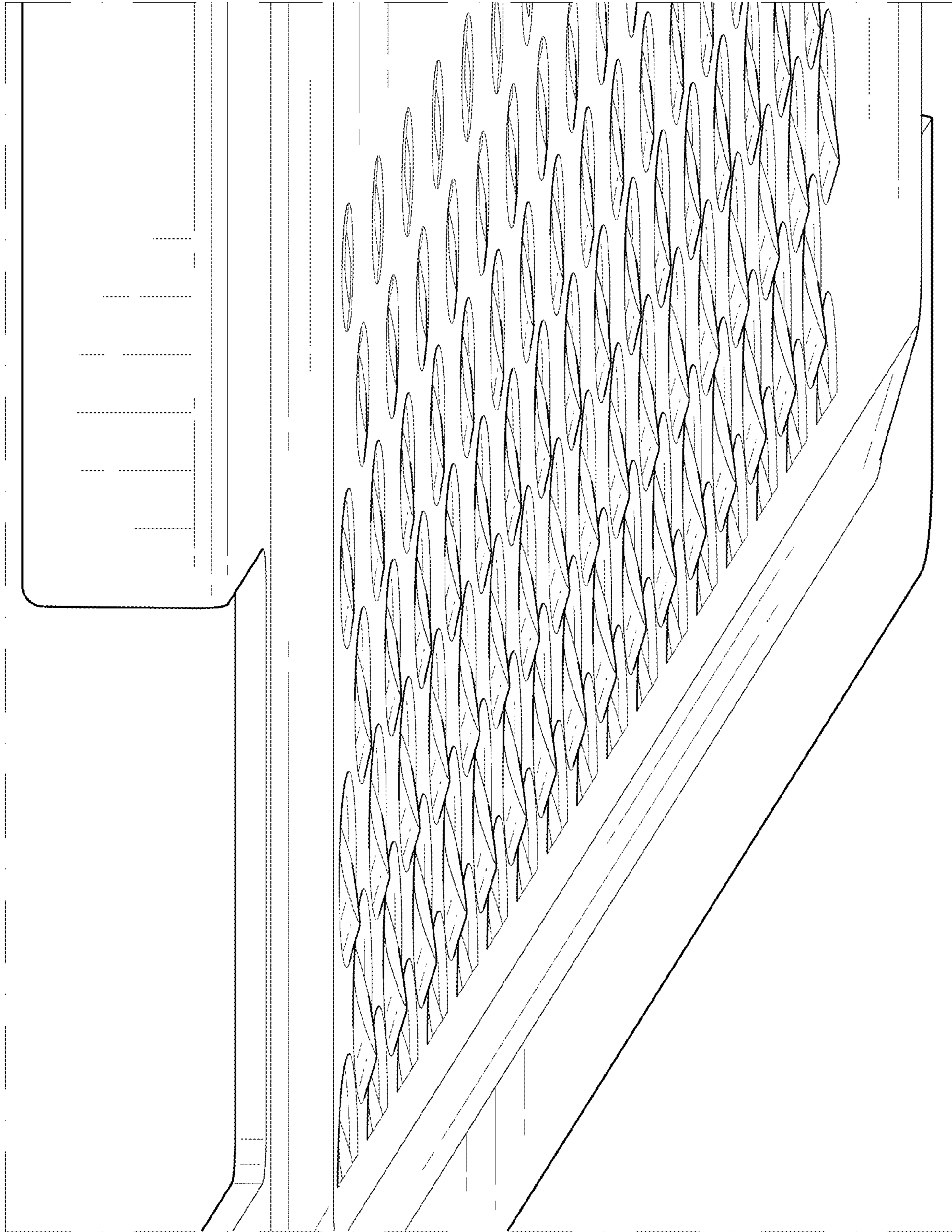

FIG. 18

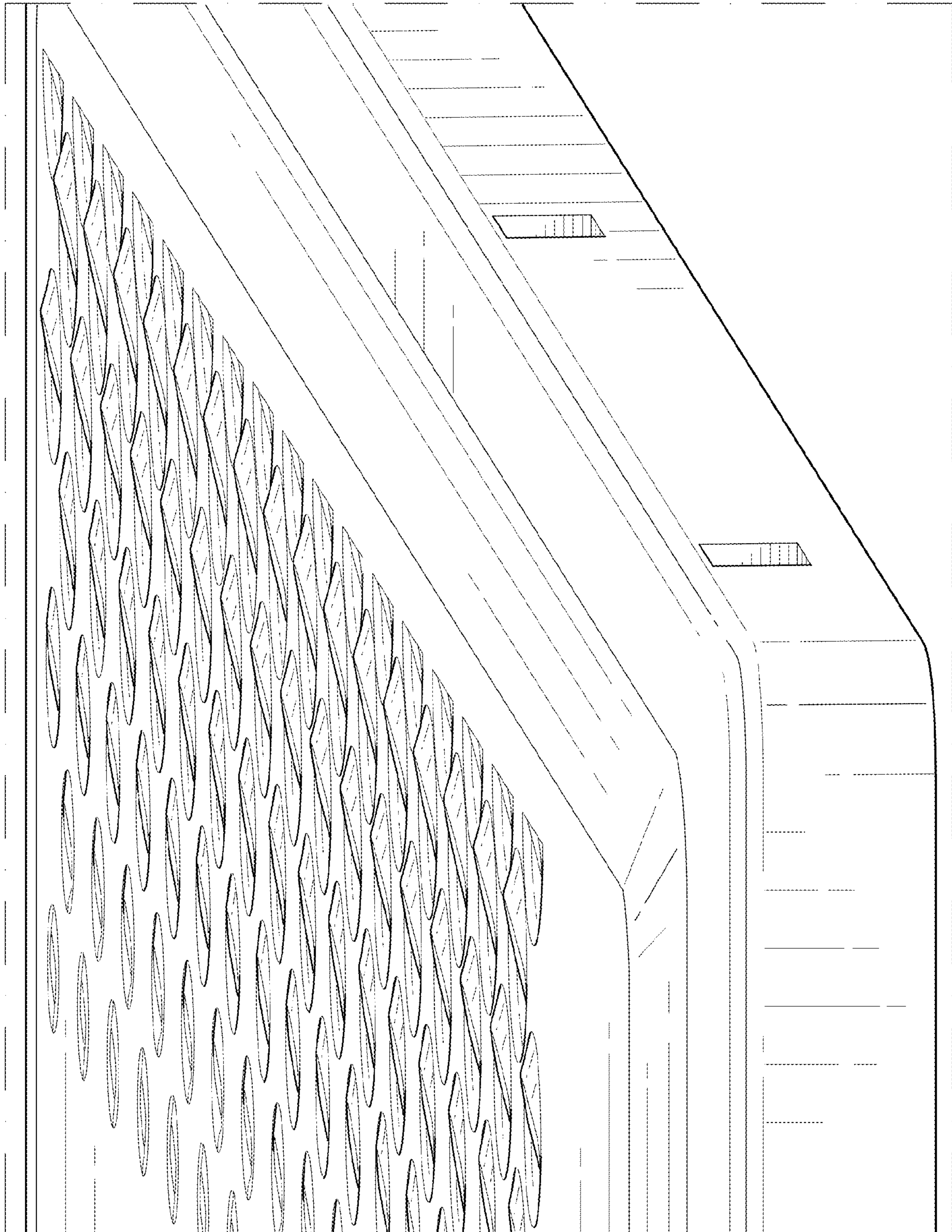

FIG. 19

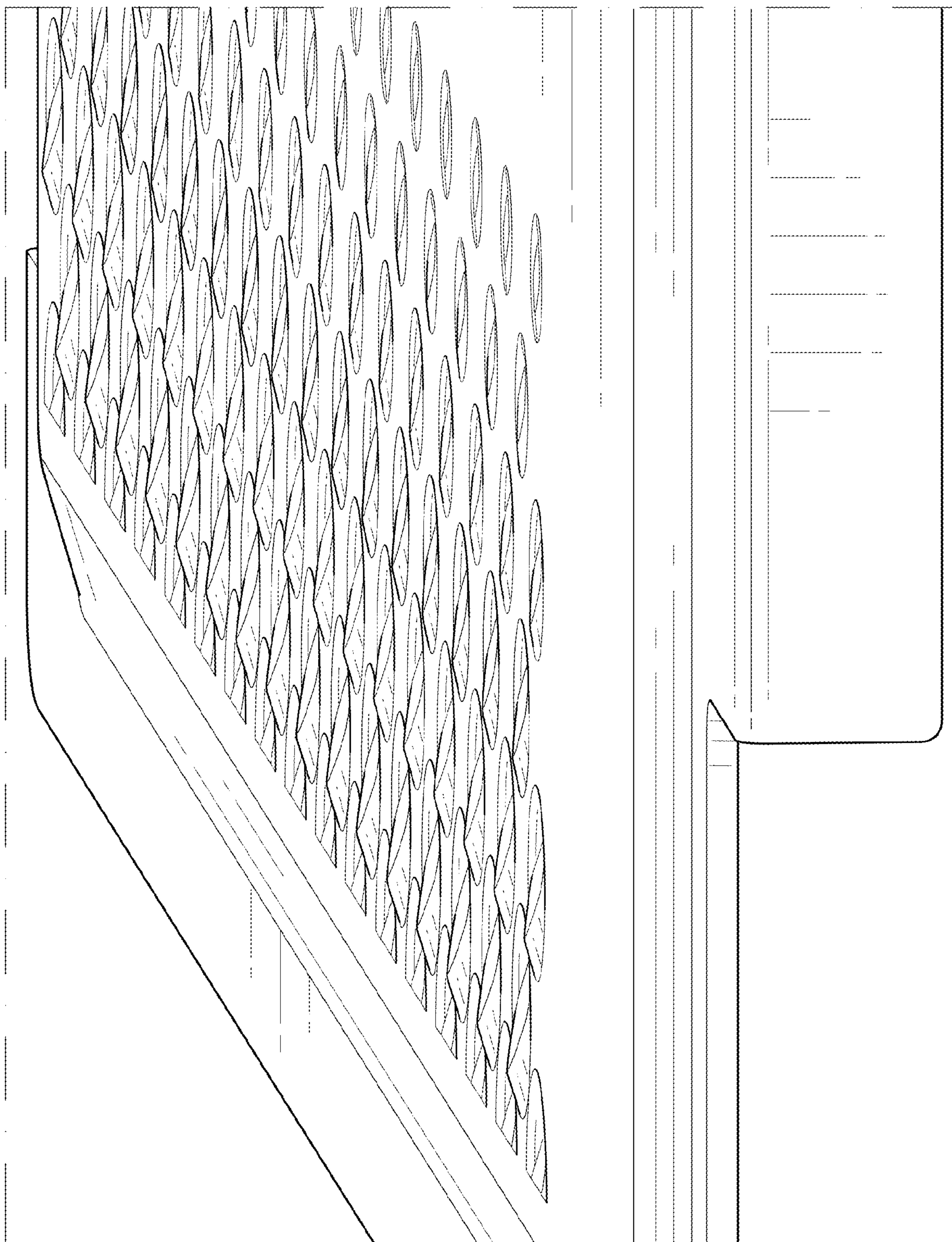

FIG. 20