



US00D961480S

(12) **United States Design Patent** (10) **Patent No.:** **US D961,480 S**
Wang et al. (45) **Date of Patent:** **** Aug. 23, 2022**

(54) **VEHICLE FLOOR MAT**

OTHER PUBLICATIONS

(71) Applicant: **Waymo LLC**, Mountain View, CA (US)

“Profile Floor Liners” Westin., posted date Jul. 5, 2017 [online], [retrieved on May 4, 2022], Retrieved from the Internet <URL: <https://www.westinautomotive.com/profile-floor-liners>> (Year: 2017).*

(72) Inventors: **Zhaokun Wang**, Mountain View, CA (US); **Brett Kurpiewski**, Mountain View, CA (US); **Thomas Southworth**, Royal Oak, MI (US); **YooJung Ahn**, Mountain View, CA (US)

(Continued)

Primary Examiner — Darlington Ly

Assistant Examiner — Nasim Abdulaziz Ali

(74) *Attorney, Agent, or Firm* — Banner & Witcoff, Ltd.

(73) Assignee: **Waymo LLC**, Mountain View, CA (US)

(57) **CLAIM**

The ornamental design for a vehicle floor mat, as shown and described.

(**) Term: **15 Years**

DESCRIPTION

(21) Appl. No.: **29/822,471**

(22) Filed: **Jan. 10, 2022**

Related U.S. Application Data

(62) Division of application No. 29/717,756, filed on Dec. 19, 2019, now Pat. No. Des. 942,912.

(51) **LOC (13) Cl.** **12-16**

(52) **U.S. Cl.**
USPC **D12/203**

(58) **Field of Classification Search**
USPC D12/203, 221; D6/582–586, 592–594
CPC B60N 3/044; B60N 3/04; B60R 13/01
See application file for complete search history.

FIG. 1 is a front perspective view of a vehicle floor mat showing our new design in accordance to a first embodiment;

FIG. 2 is a front elevation view thereof;

FIG. 3 is a rear elevation view thereof;

FIG. 4 is a right side elevation view thereof;

FIG. 5 is a left side elevation view thereof;

FIG. 6 is a top plan view thereof;

FIG. 7 is a bottom plan view thereof;

FIG. 8 is a front perspective view of a vehicle floor mat showing our new design in accordance to a second embodiment;

FIG. 9 is a front elevation view thereof;

FIG. 10 is a rear elevation view thereof;

FIG. 11 is a right side elevation view thereof;

FIG. 12 is a left side elevation view thereof;

FIG. 13 is a top plan view thereof; and,

FIG. 14 is a bottom plan view thereof.

The broken lines in the figures illustrate portions of the vehicle floor mat that form no part of the claimed design.

The dash-dot lines indicate a boundary or perimeter of the vehicle floor mat and form no part of the claimed design.

(56) **References Cited**

U.S. PATENT DOCUMENTS

4,377,614 A	3/1983	Alfter et al.	
D377,780 S *	2/1997	MacNeil	D12/221
D413,854 S *	9/1999	Vitoorapakorn	D12/221
D417,182 S *	11/1999	Vitoorapakorn	D12/221
D418,800 S *	1/2000	Atkin	D12/221
D419,951 S *	2/2000	Emery	D12/221

(Continued)

1 Claim, 8 Drawing Sheets

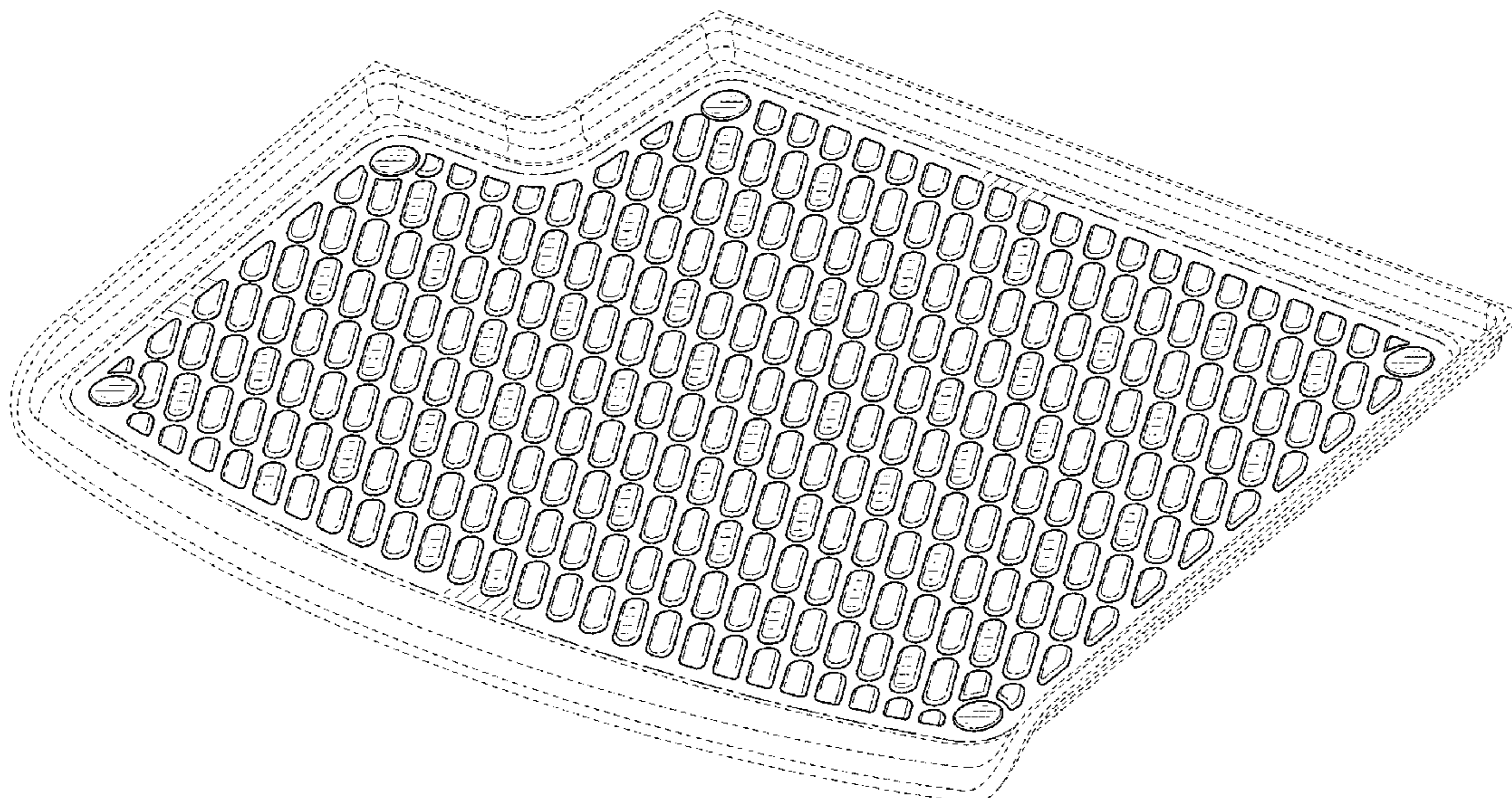

(56)

References Cited

U.S. PATENT DOCUMENTS

D425,851 S * 5/2000 Tucker D12/221
 6,238,765 B1 5/2001 Bailey et al.
 D468,249 S * 1/2003 Lu D12/203
 D472,511 S 4/2003 Lu
 6,793,872 B1 * 9/2004 Buss B29C 51/10
 264/138
 D514,493 S 2/2006 MacNeil
 D530,250 S 10/2006 Thom
 D610,062 S 2/2010 Lu
 D612,315 S 3/2010 Narazaki
 D673,490 S * 1/2013 Koblenzer D12/203
 D718,697 S 12/2014 Koblenzer et al.
 D735,110 S 7/2015 Wagner et al.
 9,533,466 B2 1/2017 Assil
 D793,934 S 8/2017 Alesi et al.
 D798,796 S * 10/2017 Yang D12/331
 D800,041 S 10/2017 Alesi et al.
 D800,043 S 10/2017 Alesi et al.
 D809,445 S 2/2018 Gonzalez et al.
 D813,776 S * 3/2018 Jaimes D12/203
 D832,173 S 10/2018 Ying
 D843,291 S 3/2019 Lu
 D852,106 S 6/2019 Alesi et al.
 D877,675 S * 3/2020 Khamtanh D12/203
 D915,975 S * 4/2021 Roh D12/203
 D919,536 S * 5/2021 Diamond D12/203
 2011/0101723 A1 * 5/2011 Wise B60R 13/01
 296/39.1

OTHER PUBLICATIONS

“Lloyd®—Rubbertite™ Custom Fit All-Weather Protection Floor Mat” IDCARID., posted date Nov. 27, 2021 [online], [retrieved on May 4, 2022], Retrieved from the Internet <URL: <https://www.carid.com/lloyd-mats/lloyd-rubbertite-floor-mats-161257.html>> (Year: 2021).*

“The 12 Best Car Floor Mats for Your Ride” popularmechanics., posted date Nov. 15, 2021 [online], [retrieved on May 4, 2022], Retrieved from the Internet <URL: <https://www.popularmechanics.com/cars/g36162435/best-car-floor-mats/>> (Year: 2021).*

“Trimable Heavy-Duty Vinyl Cargo Mat” FH Group., posted date Feb. 16, 2017 [online], [retrieved on Jun. 2, 2021]. Retrieved from the Internet <URL: <https://www.homedepot.com/p/FH-Group-56-in-x-43-in-Trimable-Heavy-Duty-Vinyl-Cargo-Mat-DMF16400GRAY/311927809>> (Year: 2017).

“Black All Season Protection Cargo Mat” FH Group., posted date Jun. 16, 2016 [online], [retrieved on Jun. 2, 2021]. Retrieved from the Internet <URL: https://www.amazon.com/FH-Group-F16400BLACK-Protection-Trimable/dp/B01H4QPJ5S/ref=sr_1_5?dchild=1&keywords=cargo+mat+liner&qid=1622677015&sr=8-5> (Year: 2016).

“Husky Liners®—Classic Style™ Cargo Liner” IDCarid., [online], [retrieved on Jun. 2, 2021]. Retrieved from the Internet <URL: <https://www.carid.com/1996-toyota-4runner-cargo-liner/husky-trunk-mat-192263.html>> <<http://www.carid.com/1996-toyota-4runner-cargo-liner/husky-trunk-mat-192263.html>>(Year: 2012).

* cited by examiner

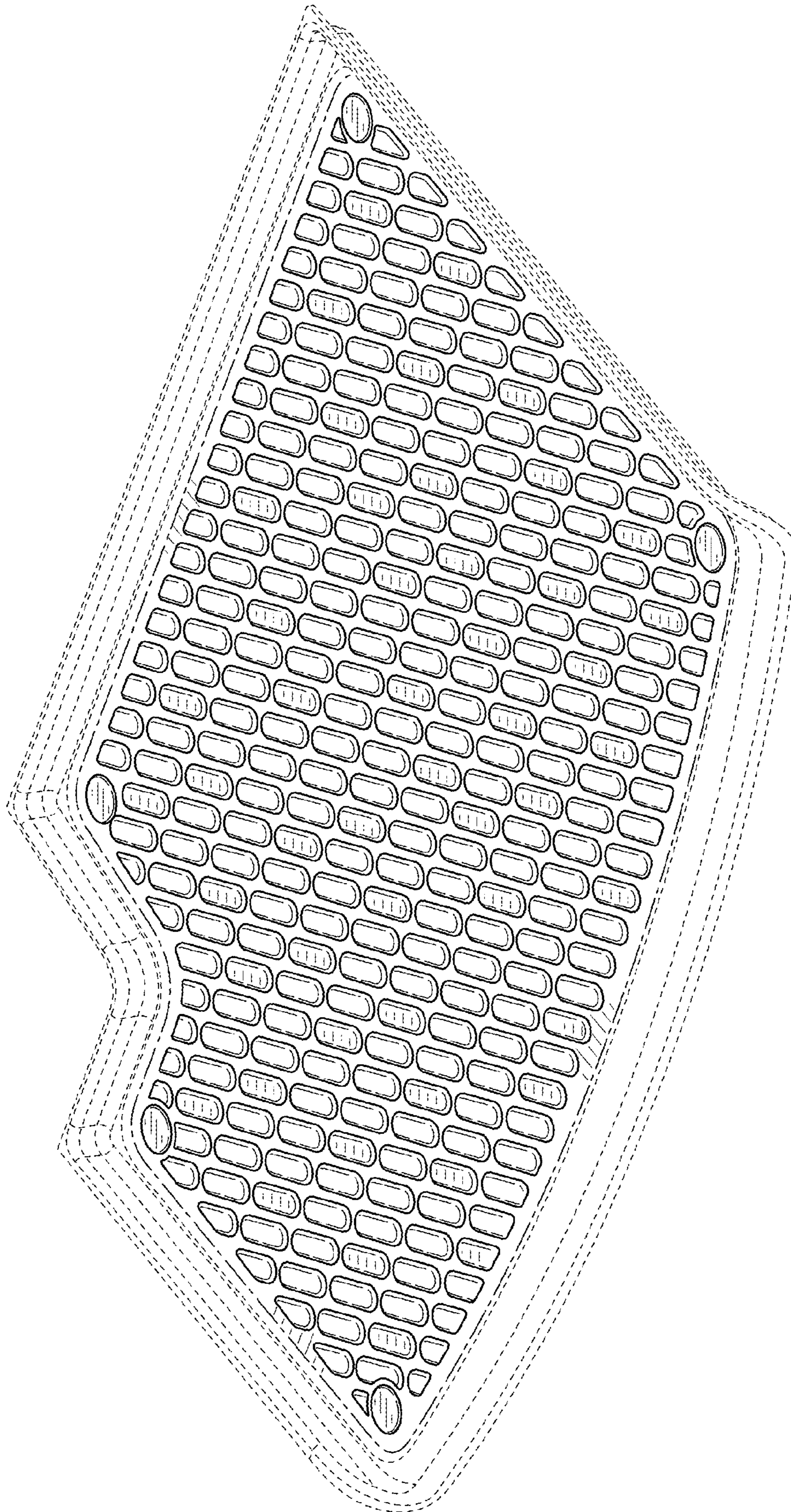

FIG. 1

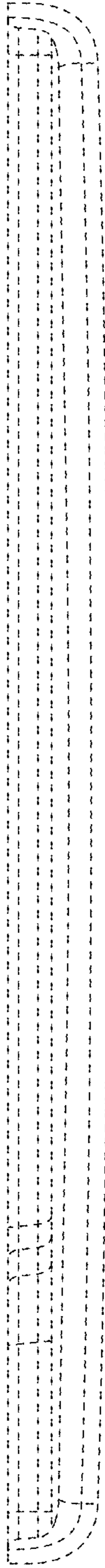

FIG. 2

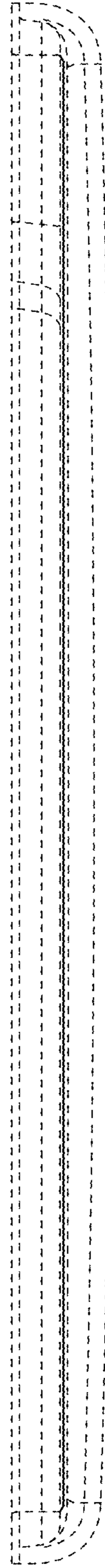

FIG. 3

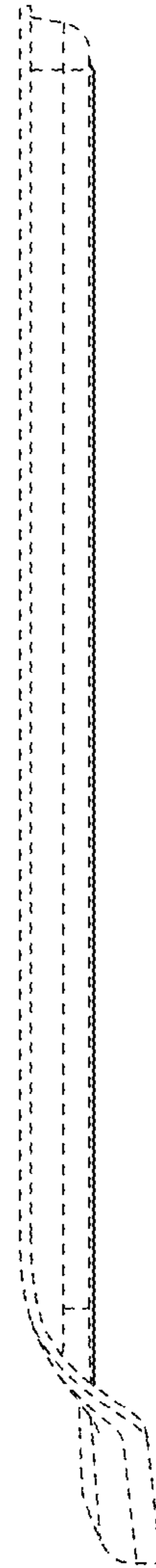

FIG. 4

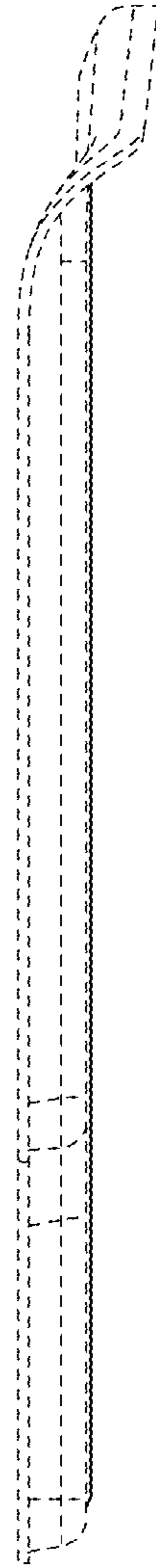

FIG. 5

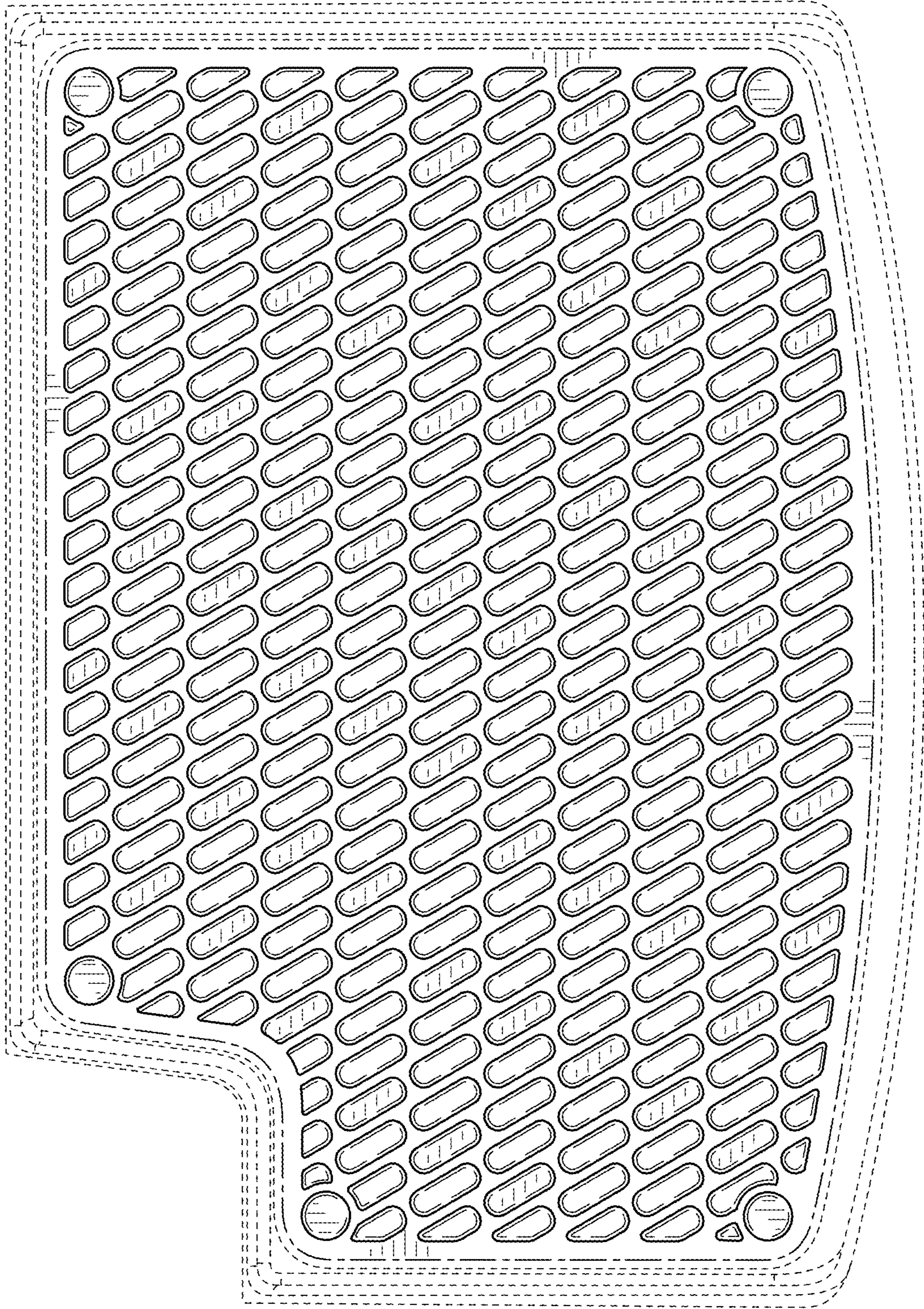

FIG. 6

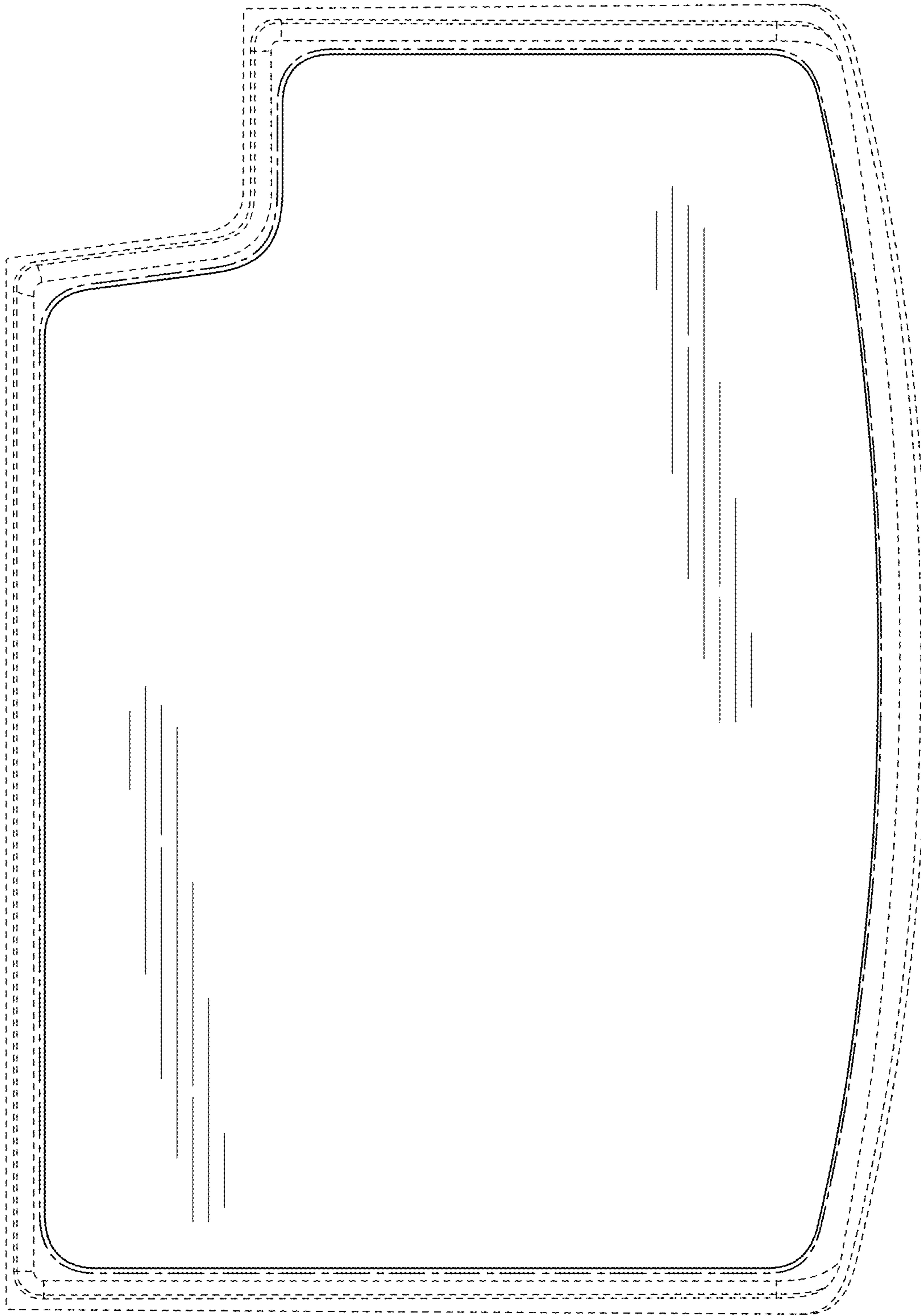

FIG. 7

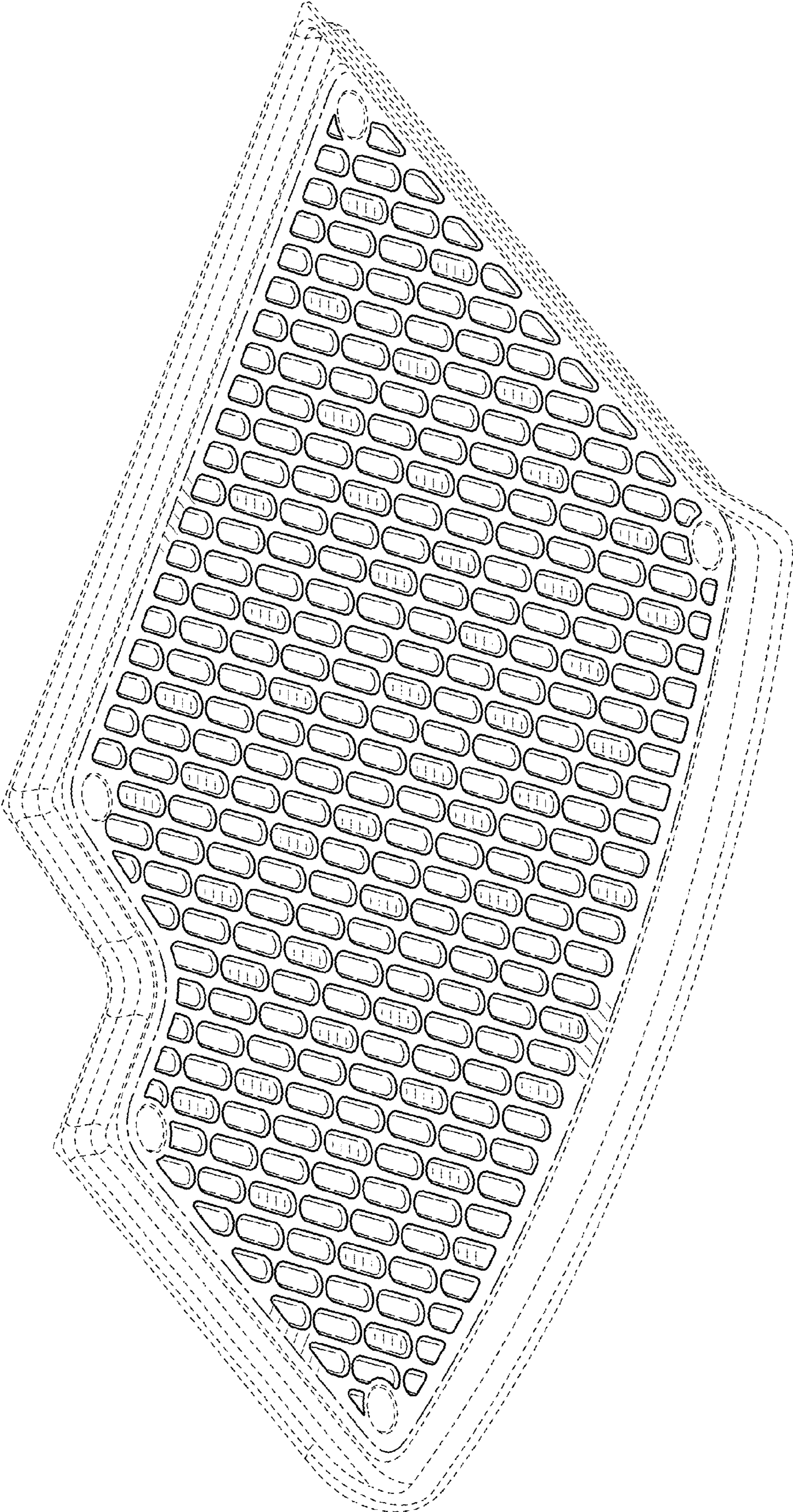

FIG. 8

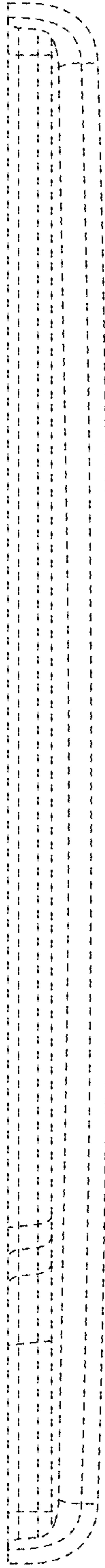

FIG. 9

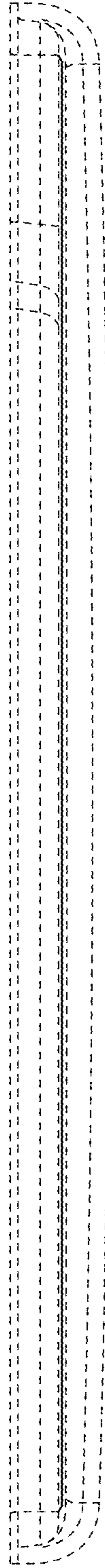

FIG. 10

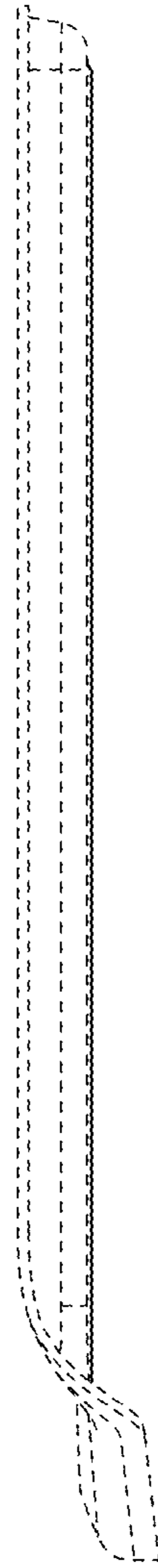

FIG. 11

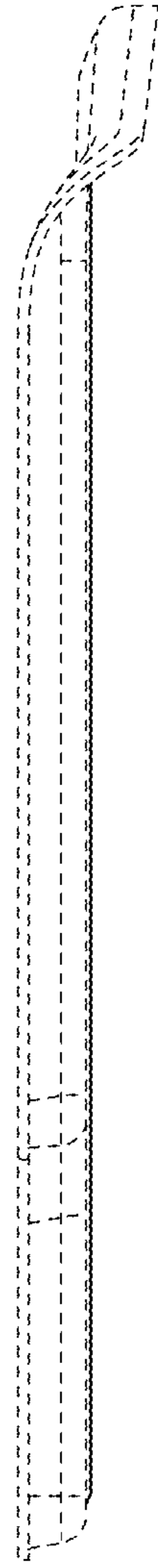

FIG. 12

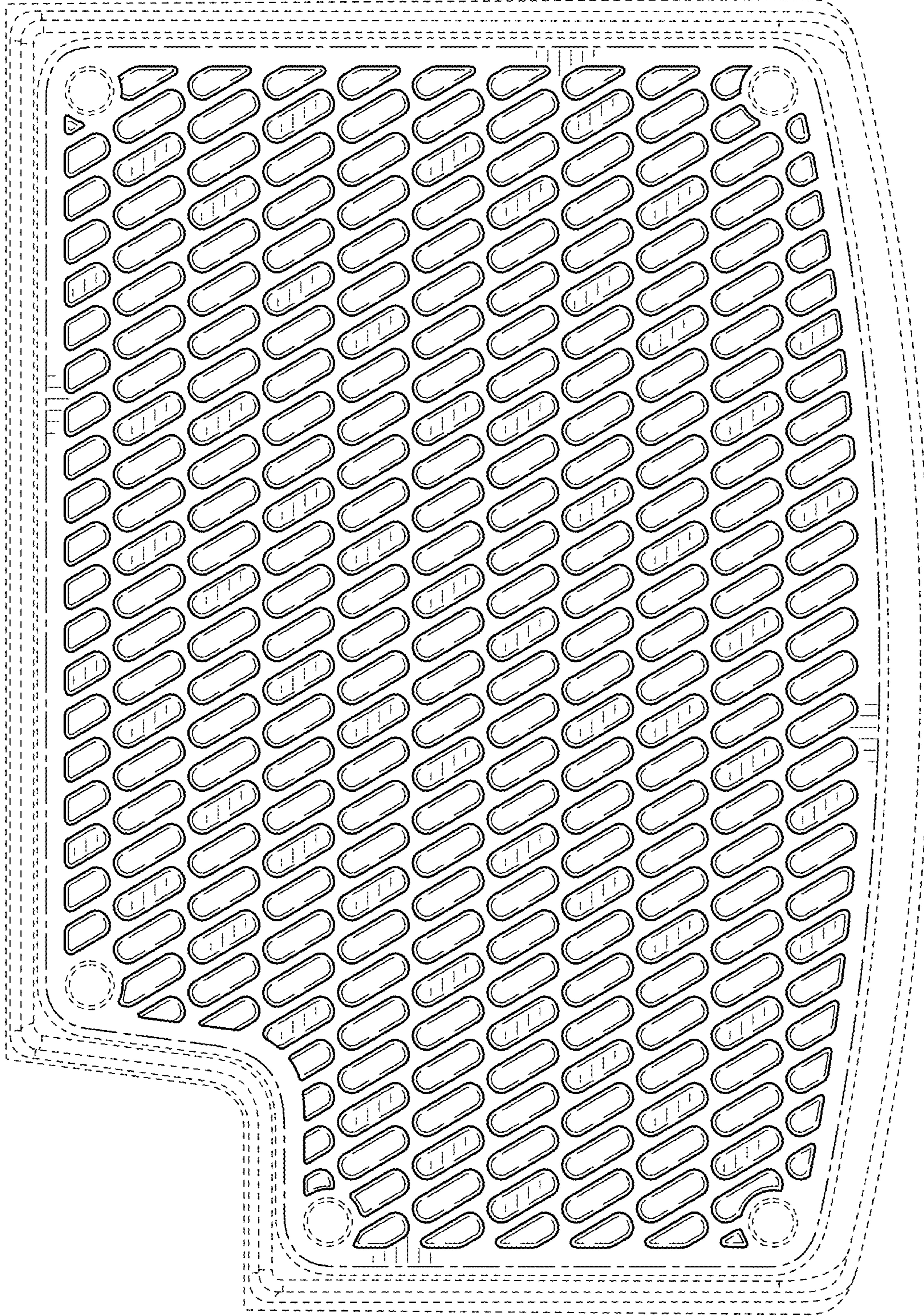

FIG. 13

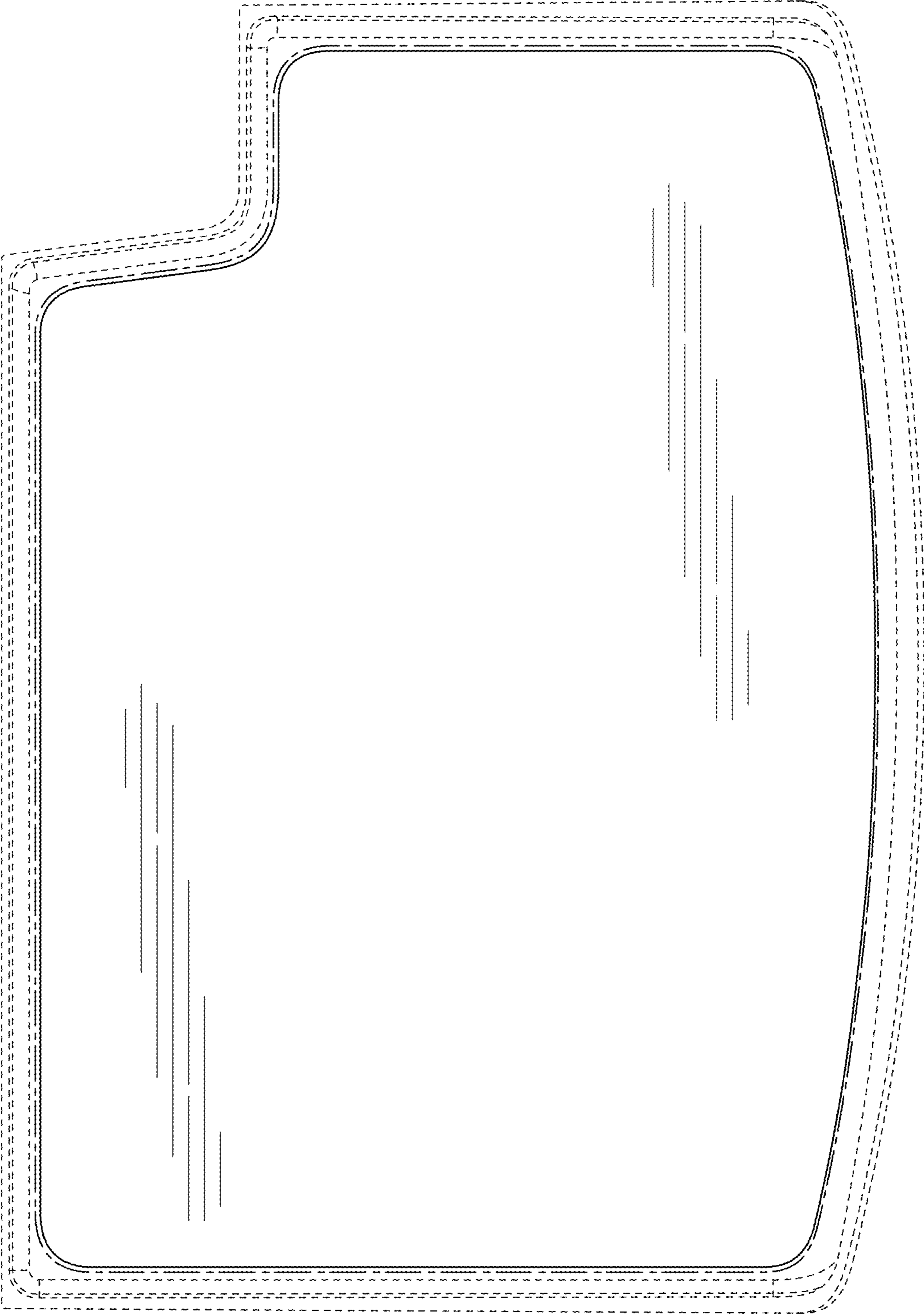

FIG. 14