

US00D961313S

(12) **United States Design Patent** (10) **Patent No.:** **US D961,313 S**  
**Climent** (45) **Date of Patent:** **\*\* Aug. 23, 2022**

(54) **SHEET MUSIC STAND**

(71) Applicant: **Alexandra Climent**, Barryville, NY (US)

(72) Inventor: **Alexandra Climent**, Barryville, NY (US)

(\*\*) Term: **15 Years**

(21) Appl. No.: **29/757,548**

(22) Filed: **Nov. 6, 2020**

(51) **LOC (13) Cl.** ..... **06-06**

(52) **U.S. Cl.**  
USPC ..... **D6/701**

(58) **Field of Classification Search**  
USPC ..... D6/672, 673, 700–702; D17/99; D19/91  
CPC ..... A47B 19/00; A47B 19/002; A47B 19/02;  
A47B 19/06; A47B 19/10

See application file for complete search history.

(56) **References Cited**

**U.S. PATENT DOCUMENTS**

D132,166 S *	4/1942	Cloutier	.....	D6/700
D237,237 S *	10/1975	Nelson	.....	D6/700
D377,276 S *	1/1997	Hirsch	.....	D6/700
D644,450 S *	9/2011	Walter	.....	D6/701
D677,075 S *	3/2013	Rodgers	.....	D6/672
D815,476 S *	4/2018	Procter	.....	D6/700
D835,441 S *	12/2018	Procter	.....	D6/700

**OTHER PUBLICATIONS**

Sheet Music Stand—Live Edge Cherry with Bubinga Accents—Woodnuts <https://woodnuts.com/product/sheet-music-stand-cherry-with-bubinga-accents/> retrieved from the internet on Jan. 19, 2022.\*  
Music Stand from Lumberjocks—Pinterest <https://www.pinterest.com/pin/446419381821479306/?d=t&mt=login> retrieved from the internet on Jan. 19, 2022.\*  
Music Stand | Northwest Woodworkers Gallery, by Seth Rolland—Pinterest <https://www.pinterest.com/pin/446419381821479306/?d=t&mt=login> retrieved from the internet on Jan. 19, 2022.\*

\* cited by examiner

*Primary Examiner* — Mary Ann Calabrese

(74) *Attorney, Agent, or Firm* — Sean R. Wilsusen

(57) **CLAIM**

The ornamental design for a sheet music stand, as shown and described.

**DESCRIPTION**

FIG. 1 is a top perspective view of a sheet music stand;  
FIG. 2 is a front view thereof;  
FIG. 3 is a rear view thereof;  
FIG. 4 is a left side view thereof;  
FIG. 5 is a right side view thereof;  
FIG. 6 is a top view thereof; and,  
FIG. 7 is bottom view thereof.

In the drawings, the broken lines show portions of the sheet music stand that form no part of the claimed design.

**1 Claim, 7 Drawing Sheets**

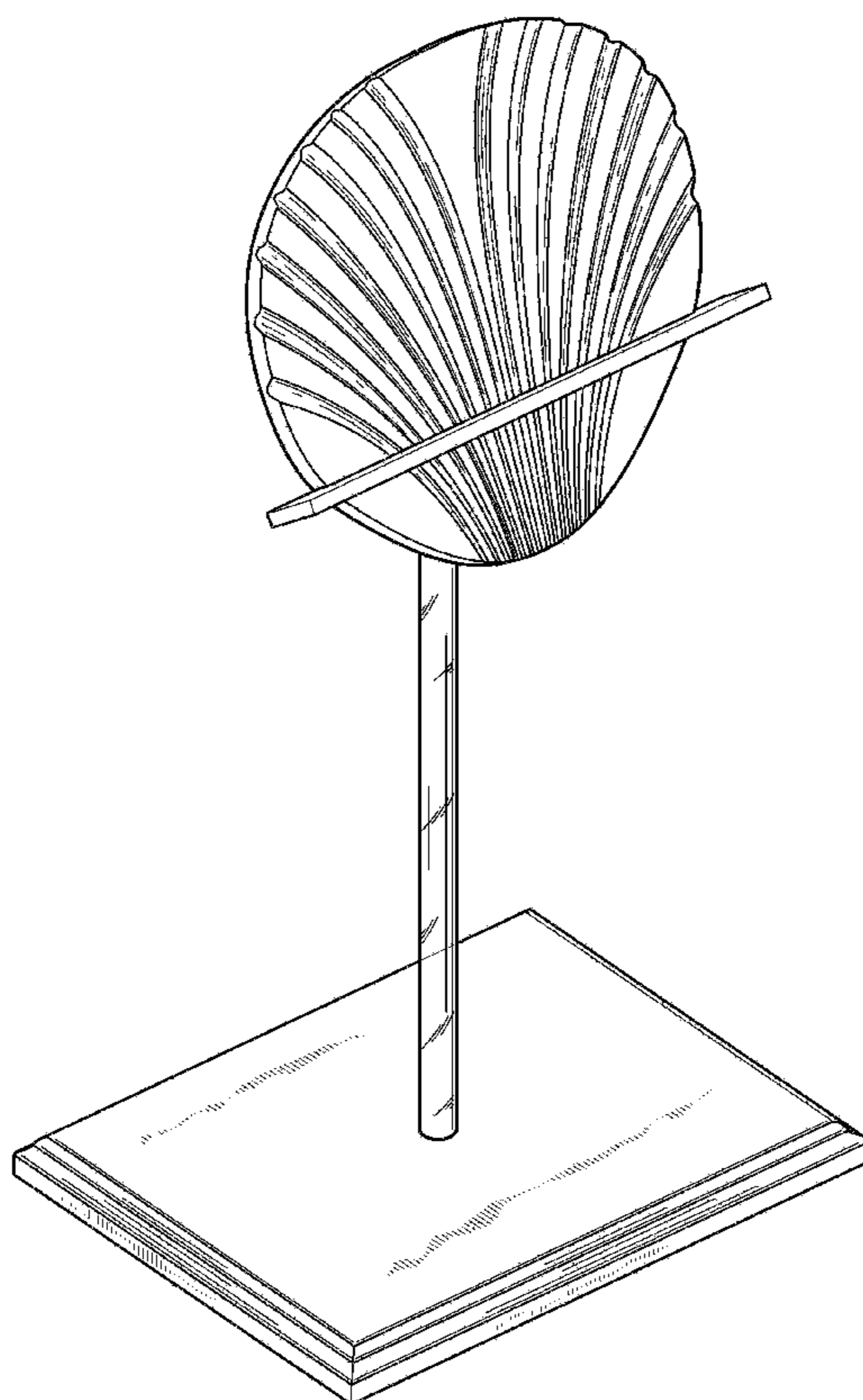

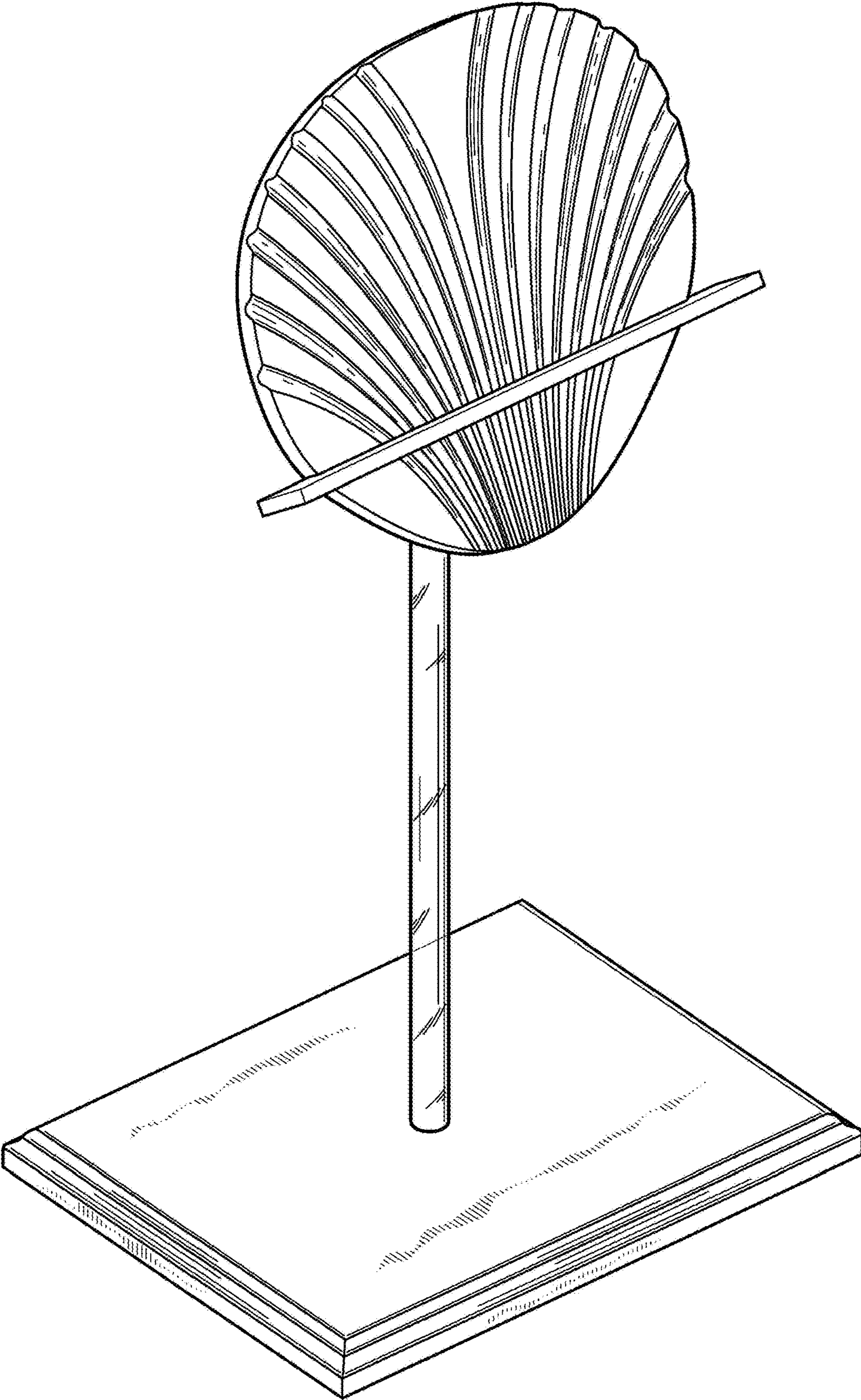
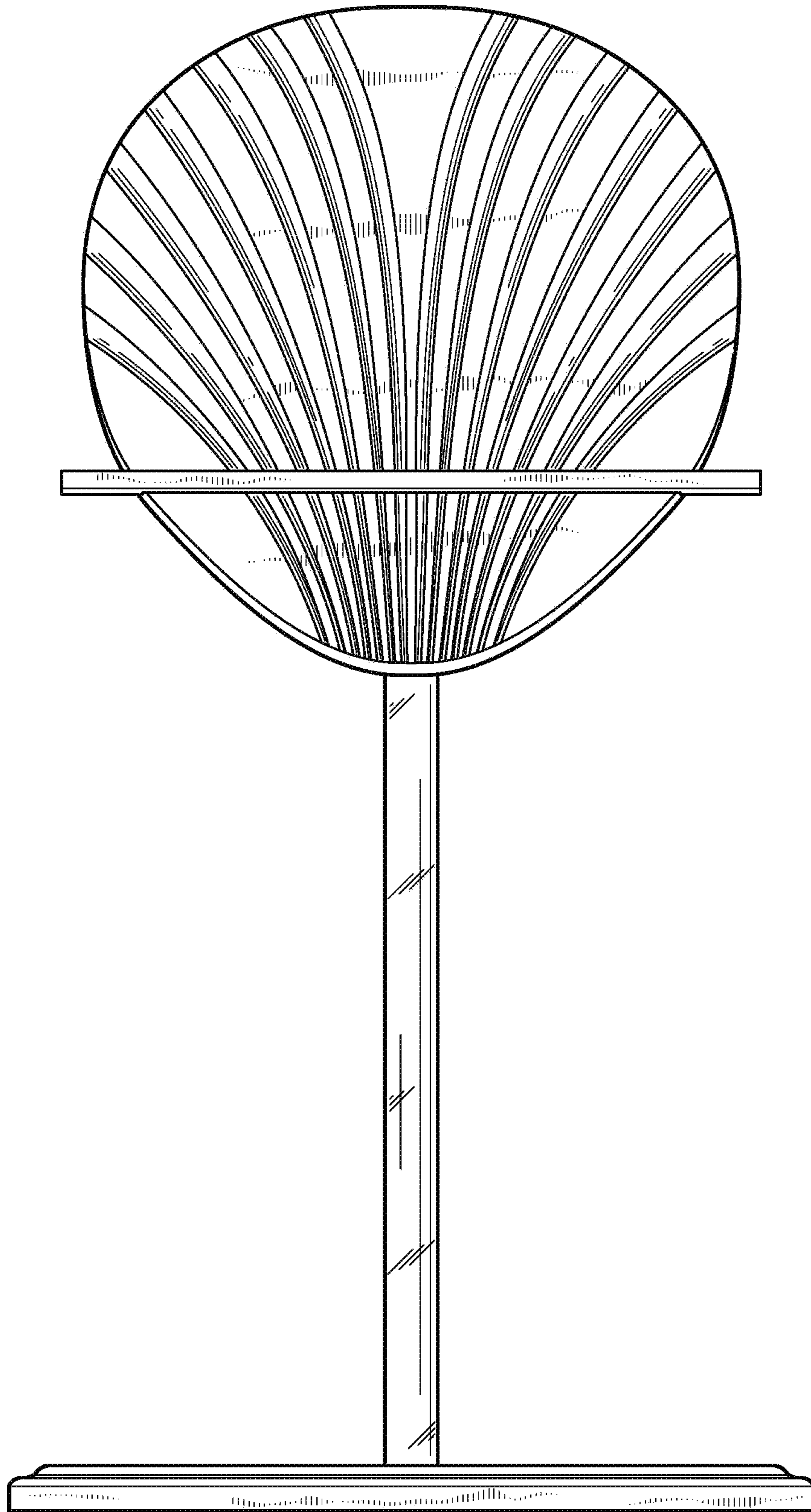

FIG. 1



**FIG. 2**

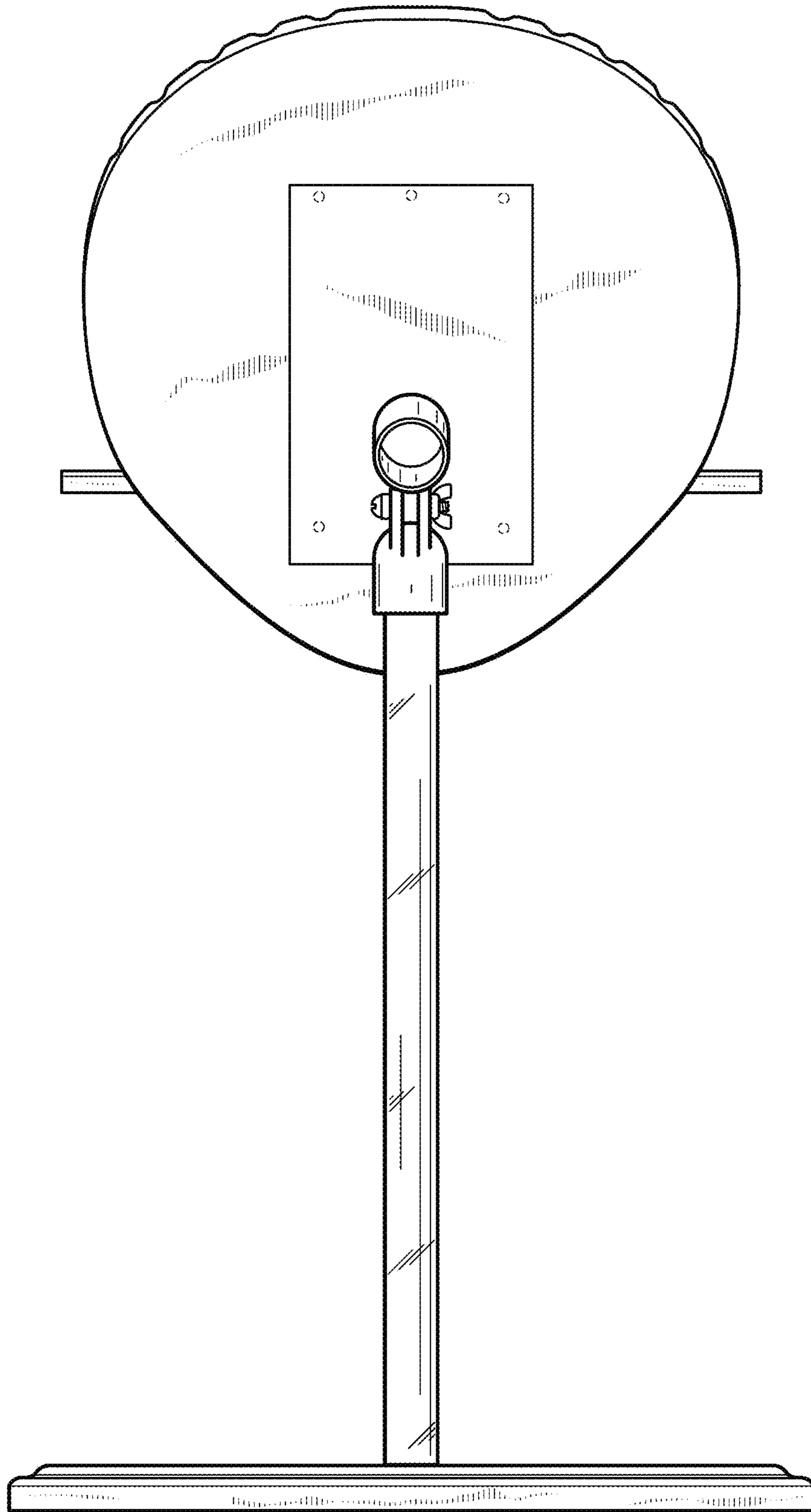
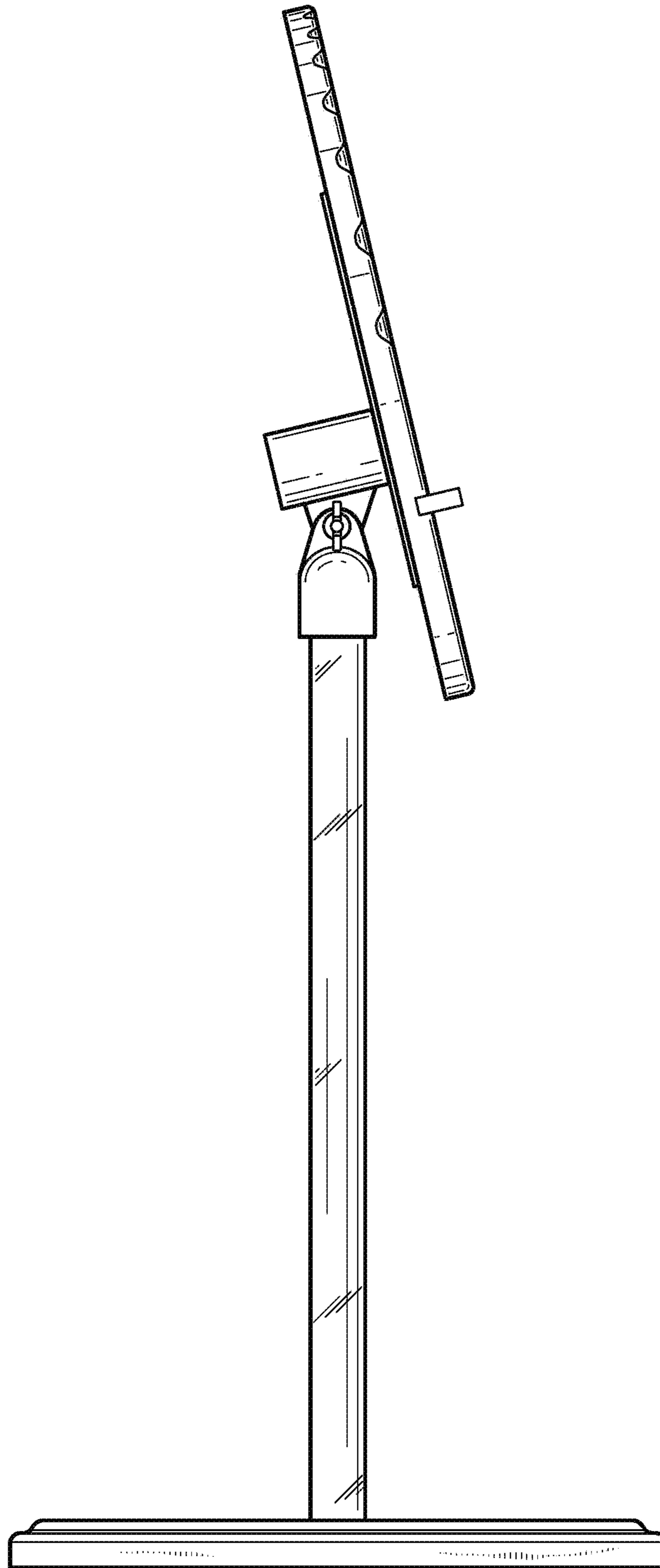
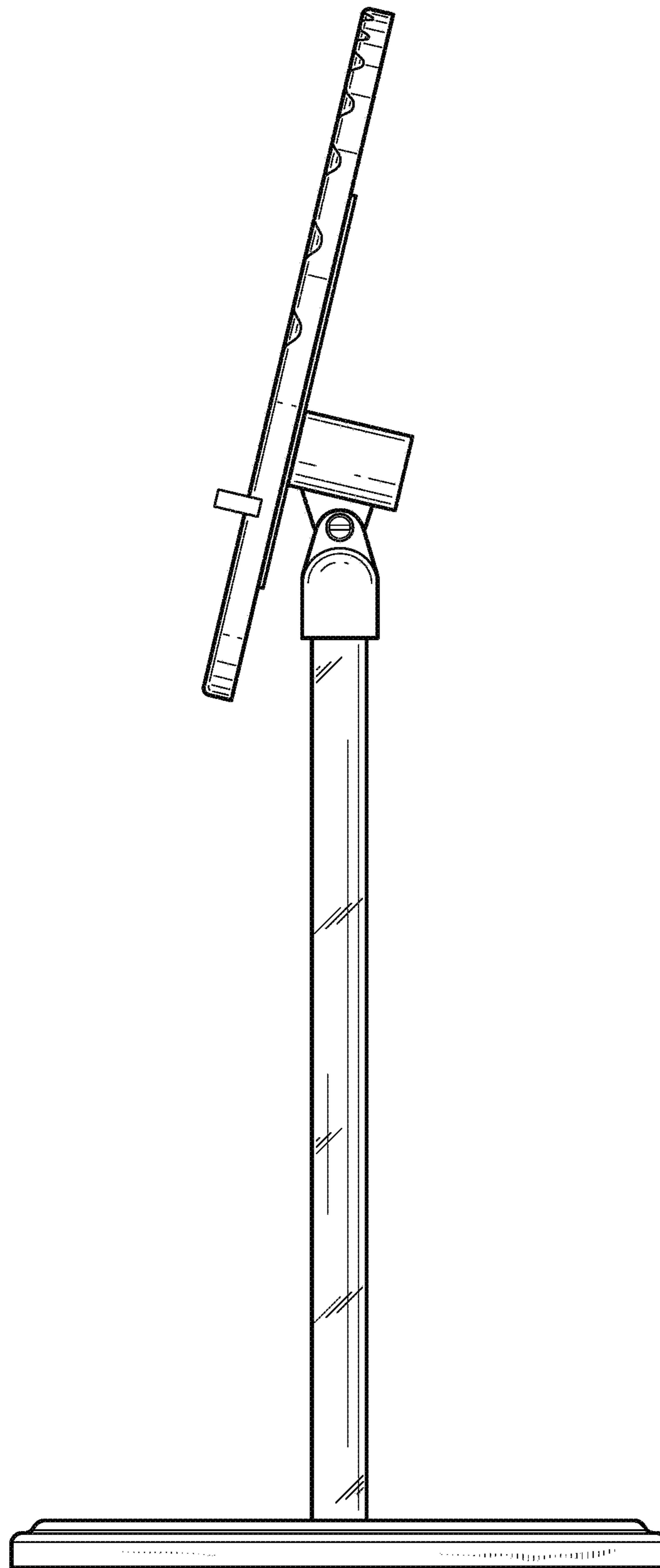

FIG. 3



**FIG. 4**



**FIG. 5**

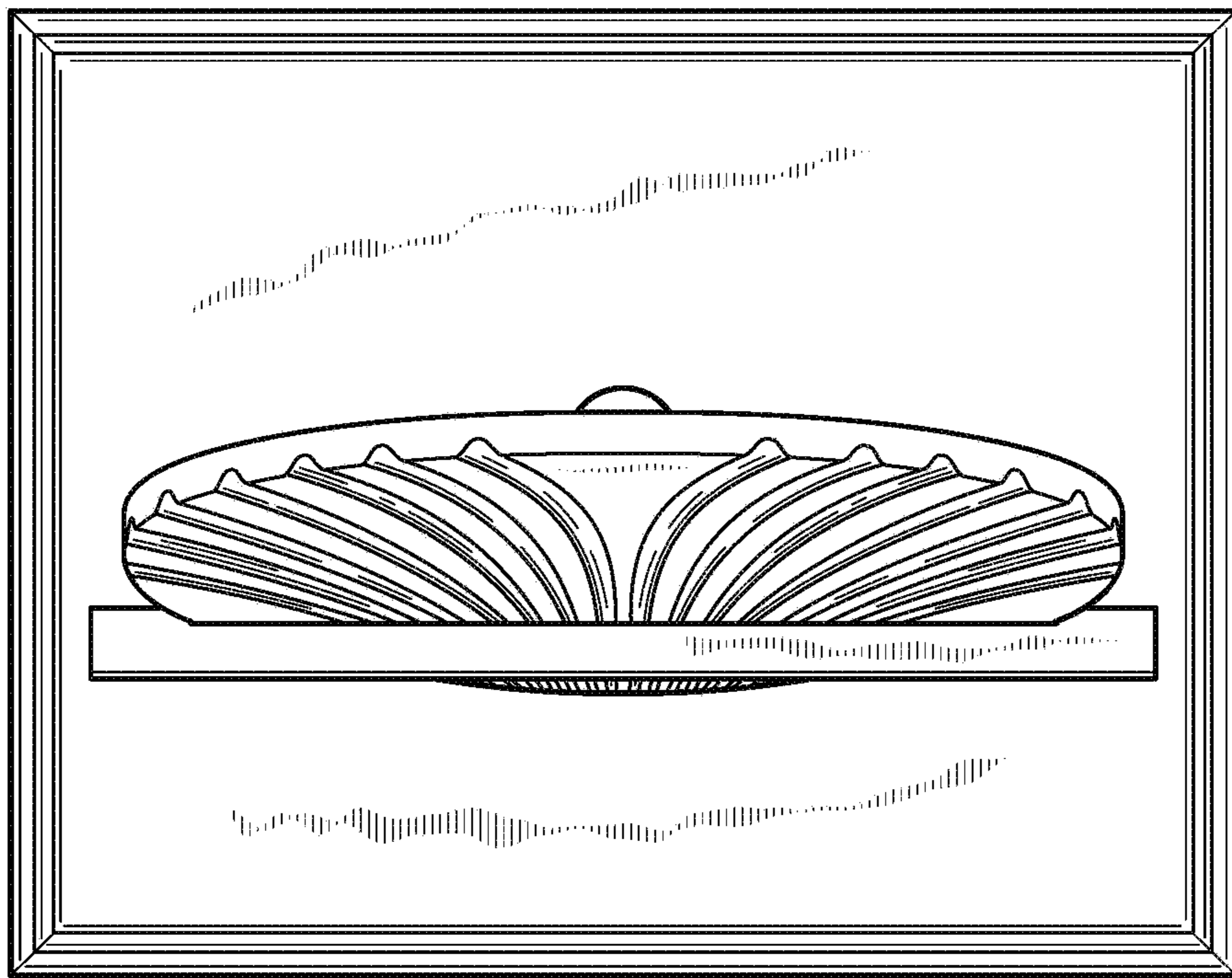

**FIG. 6**

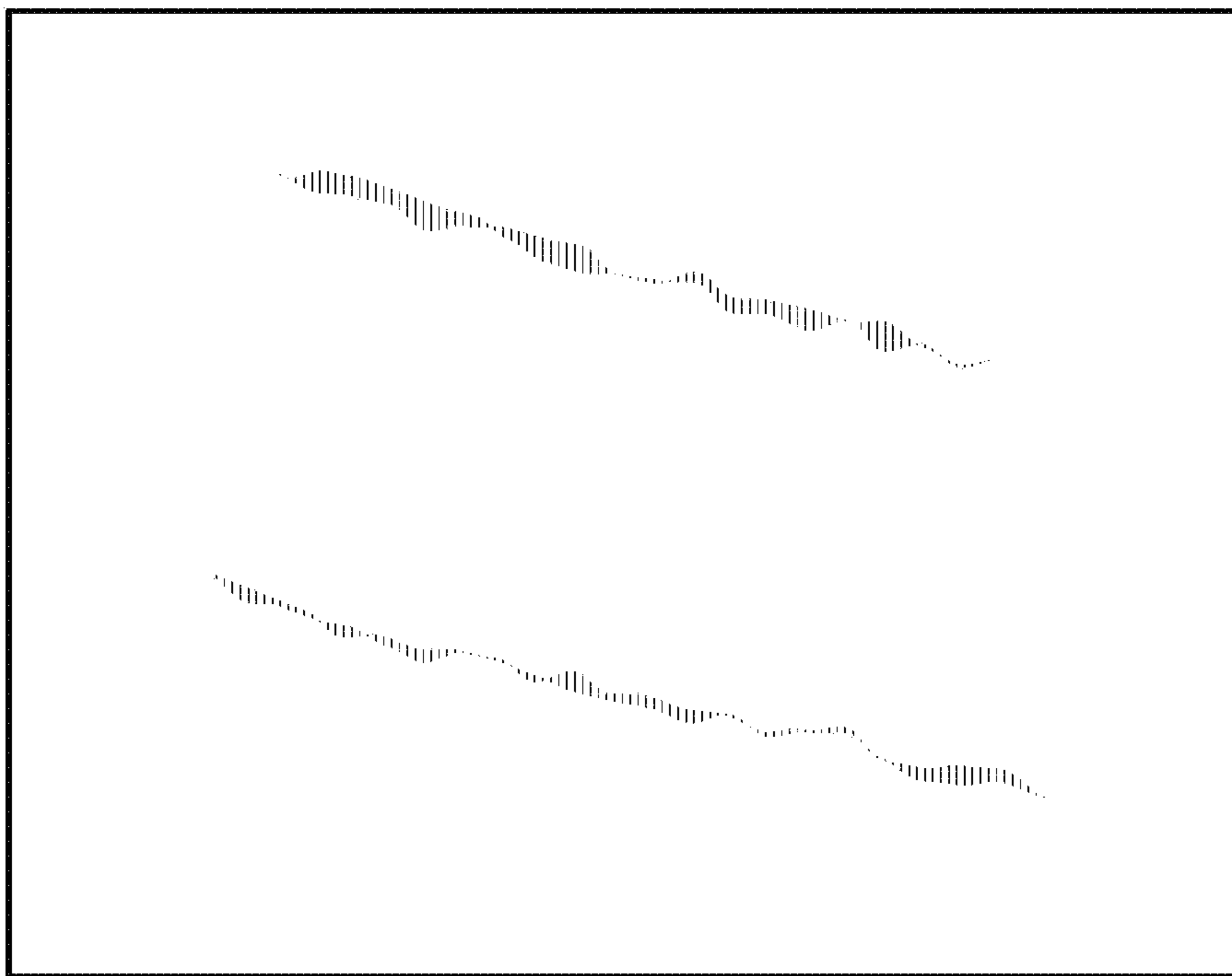

**FIG. 7**