

US00D961270S

(12) **United States Design Patent** (10) **Patent No.:** **US D961,270 S**
Jimenez et al. (45) **Date of Patent:** **** Aug. 23, 2022**

(54) **ORAL CARE IMPLEMENT**
 (71) Applicant: **Colgate-Palmolive Company**, New York, NY (US)

D817,002 S 5/2018 Wainless et al.
 D817,003 S 5/2018 Wainless et al.
 D857,396 S * 8/2019 Nguyen D4/101
 D896,528 S * 9/2020 Nguyen D4/101
 D935,192 S * 11/2021 He D4/101
 2020/0146431 A1* 5/2020 Davies-Smith A61C 17/22

(72) Inventors: **Eduardo Jimenez**, Manalapan, NJ (US); **Daniel Wainless**, New Brunswick, NJ (US); **Hannah Gorman**, Montclair, NJ (US); **How Lau Mendez**, Brooklyn, NY (US)

FOREIGN PATENT DOCUMENTS

JP D1444593 6/2012
 JP D1444965 6/2012

(Continued)

(73) Assignee: **Colgate-Palmolive Company**, New York, NY (US)

OTHER PUBLICATIONS

Hello Brush, announced May 2019 [online], [site visited Jan. 6, 2022]. Available from internet, URL: https://www.amazon.com/hello-Bpafree-Toothbrush-Grippable-Cruelty/dp/B08Z6C6BR5/ref=cm_cr_arp_d_product_top?ie=UTF8&th=1 (Year: 2019).*

(Continued)

(**) Term: **15 Years**

Primary Examiner — Cynthia Ramirez
Assistant Examiner — Tamara L Hahn

(21) Appl. No.: **29/744,650**

(22) Filed: **Jul. 30, 2020**

(51) **LOC (13) Cl.** **04-02**

(52) **U.S. Cl.**
 USPC **D4/110**

(58) **Field of Classification Search**
 USPC D4/100–138, 199; D24/176, 181
 CPC A46B 2200/1066; A46B 2200/1073; A46B 2200/1086; A46B 5/0095; A61C 17/16; A63H 13/00

See application file for complete search history.

(57) **CLAIM**

The ornamental design for an oral care implement, as shown and described.

DESCRIPTION

FIG. 1 is a front perspective view of an oral care implement showing the new design;
 FIG. 2 is a rear perspective view thereof;
 FIG. 3 is a front view thereof;
 FIG. 4 is a rear view thereof;
 FIG. 5 is a left side view thereof;
 FIG. 6 is a right side view thereof;
 FIG. 7 is an enlarged top view thereof; and,
 FIG. 8 is an enlarged bottom view thereof.
 The dashed broken lines illustrate portions of the oral care implement that form no part of the claimed design. The dot-dash broken lines define the bounds of the claimed design and form no part thereof.

(56) **References Cited**

U.S. PATENT DOCUMENTS

D476,158 S 6/2003 Ling
 D489,185 S 5/2004 Kemp et al.
 D507,406 S 7/2005 Kemp et al.
 D510,807 S 10/2005 Jimenez
 D513,126 S 12/2005 Jimenez et al.
 D697,719 S 1/2014 Xi et al.
 D698,554 S 2/2014 Xi et al.
 D738,627 S 9/2015 Xi et al.
 D751,294 S 3/2016 Xi et al.
 D776,436 S 1/2017 Xi et al.
 D783,290 S 4/2017 Lee et al.

1 Claim, 4 Drawing Sheets

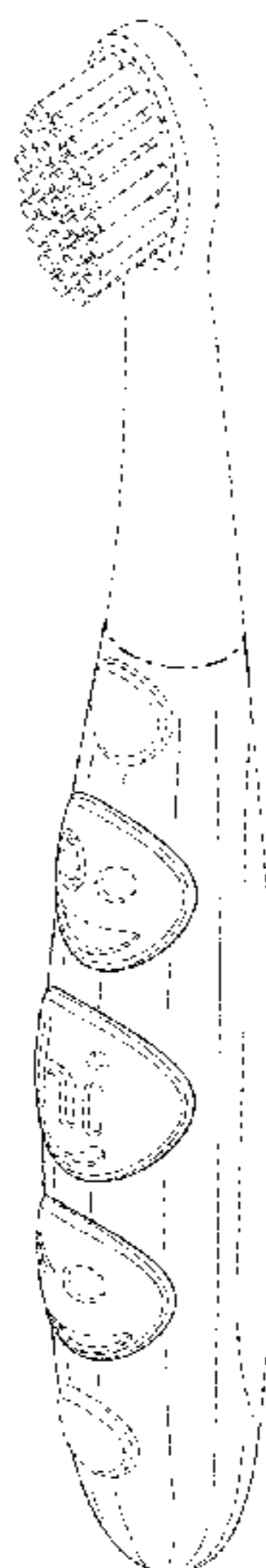

(56)

References Cited

FOREIGN PATENT DOCUMENTS

JP	D1444966	6/2012
JP	D1444967	6/2012
RU	107110 S	2/2018

OTHER PUBLICATIONS

International Trademark No. 1518955 for “hello” registered on Jan. 27, 2020, p. 1.

Russian Trademark No. 457961 for “Hello baby,” registered on Mar. 29, 2012, pp. 1-2.

Russian Trademark No. 695650, Miscellaneous Design, registered on Feb. 4, 2019, pp. 1-7.

Russian Trademark No. 696951, Hi (Stylized/Design), registered on Feb. 8, 2019, pp. 1-26.

Hello Products website, “Kids bpa-free toothbrush,” retrieved from <https://www.hello-products.com/friendly-blog/a-note-from-team-hello-march-2020/>, Mar. 2020, pp. 1-9.

Midwestdental website, “Baby/Toddler’s Stage 1 Lady Bug Toothbrush-Children-Toothbrushes-Preventive-Supplies”, retrieved from <https://www.midwestdental.com/supplies/preventives/toothbrushes/children/baby-toddlers-stage-1-lady-bug-toothbrush.html> on Jun. 26, 2020, pp. 1.

Aliexpress website, “Ruiwjx 1 6 Year Soft Bristle Kid Toothbrush Soft Cute Cartoon Oral Hygiene Clean Tool”, retrieved from https://www.aliexpress.com/i/4000091608308.html?ws_ab_test=searchweb0_0, Jun. 26, 2020, pp. 1-3.

* cited by examiner

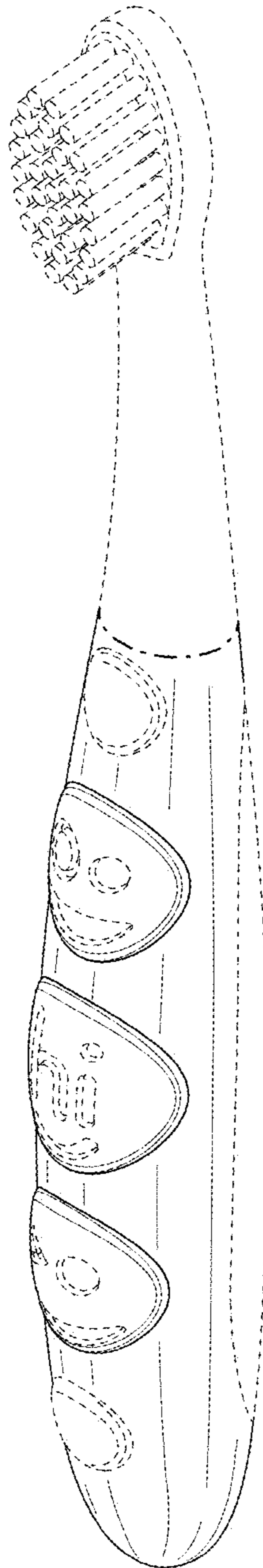

FIG. 1

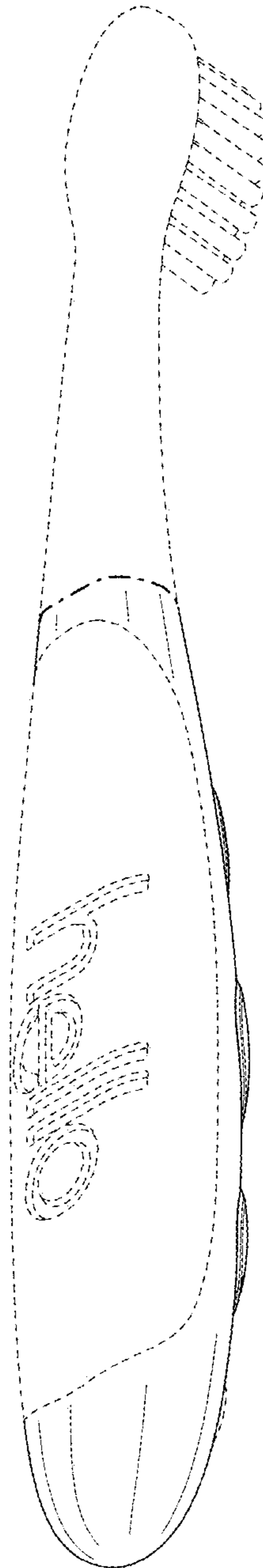

FIG. 2

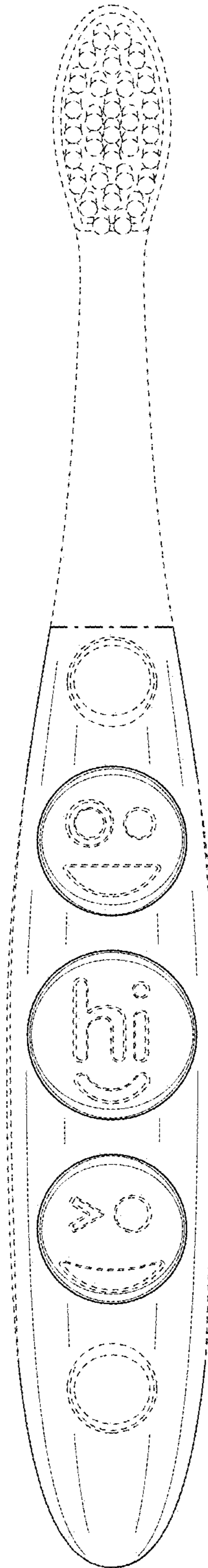

FIG. 3

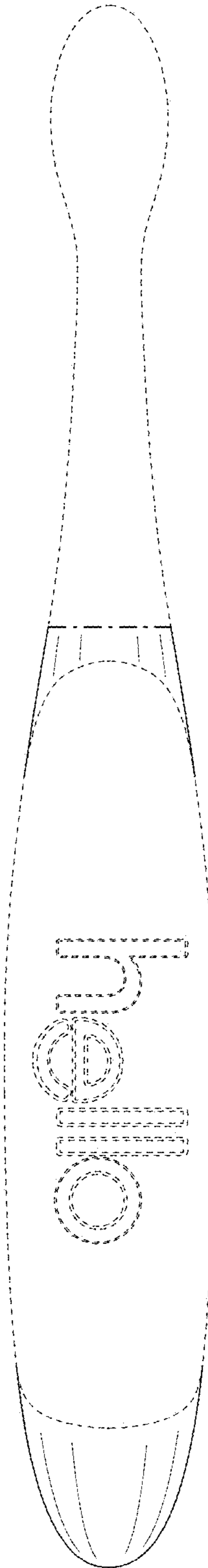

FIG. 4

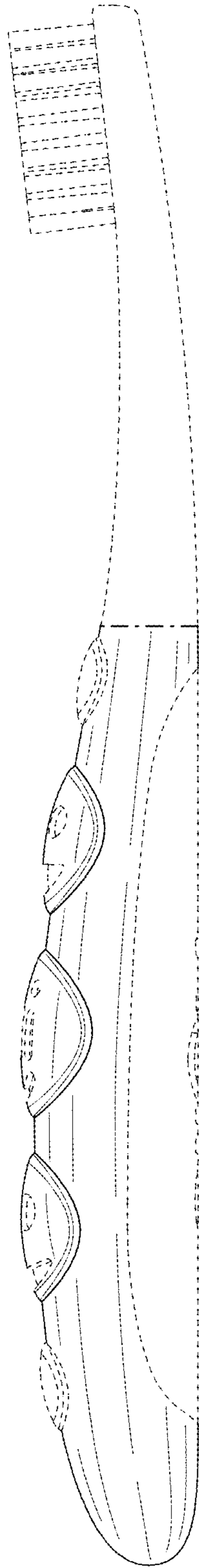

FIG. 5

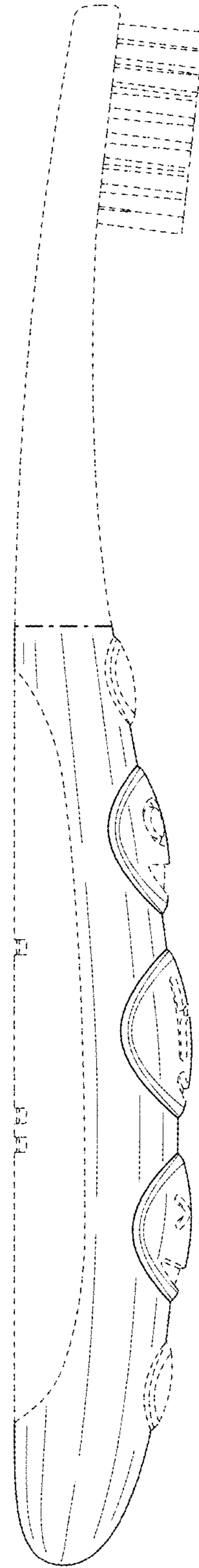

FIG. 6

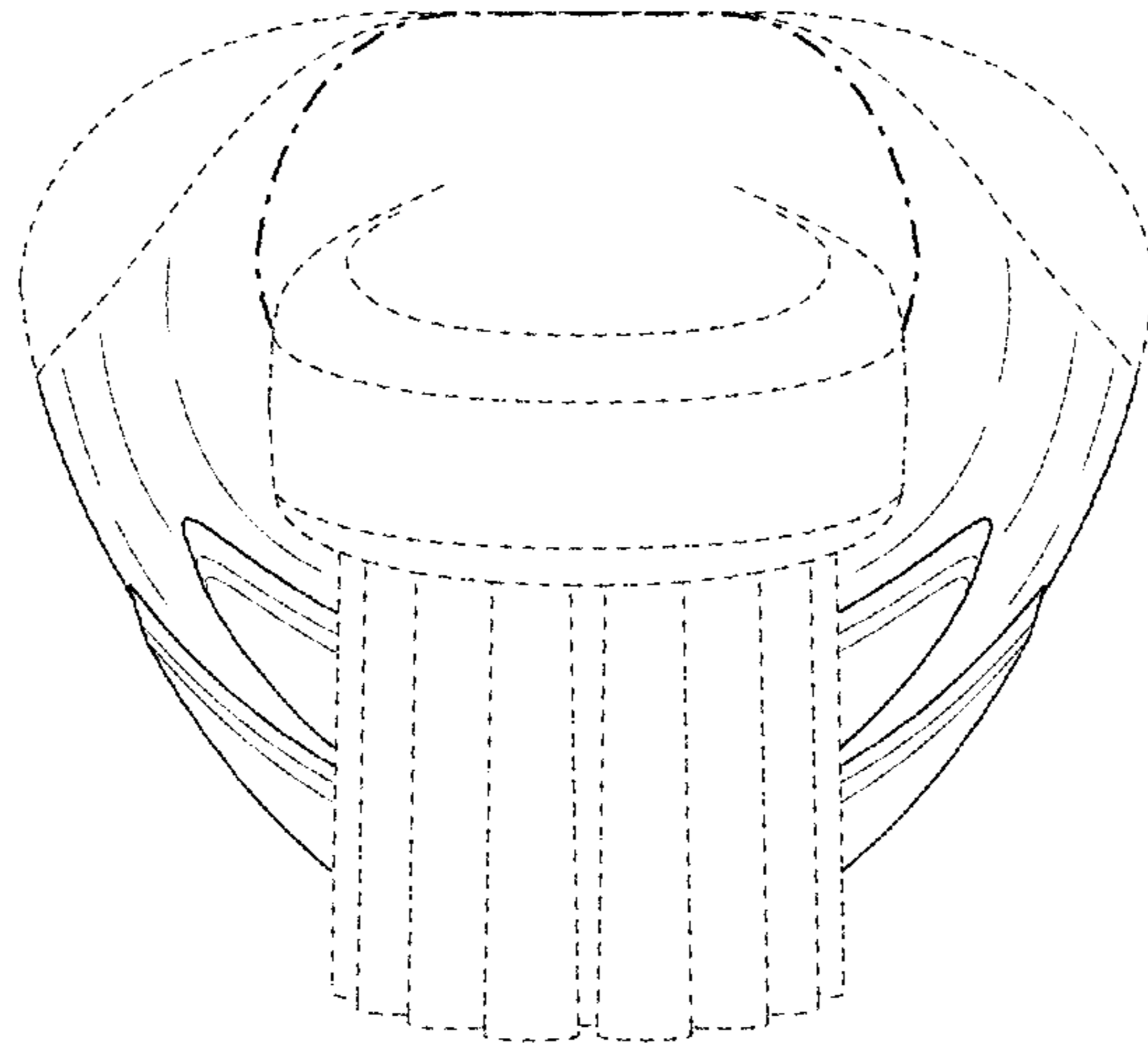

FIG. 7

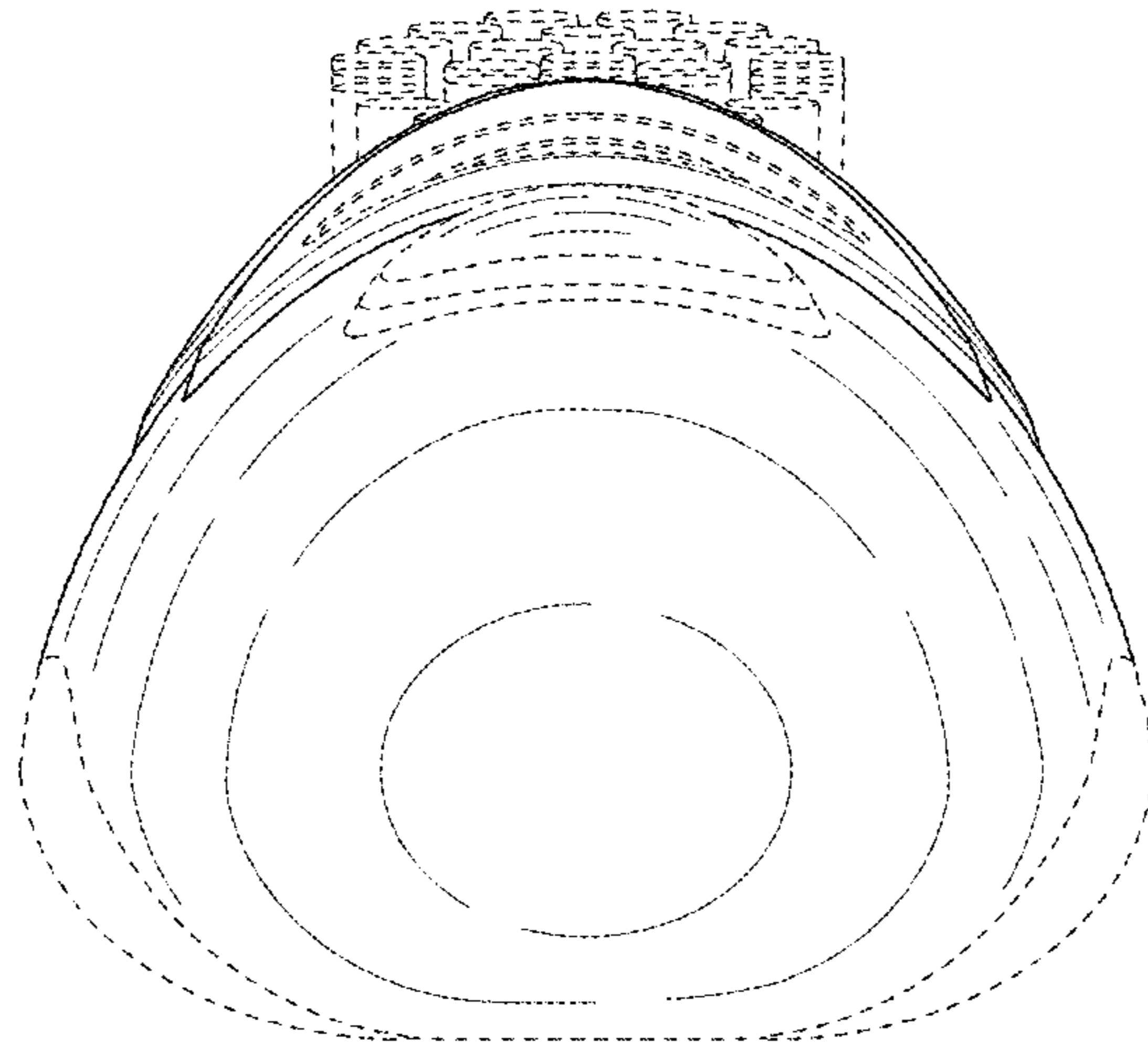

FIG. 8