



US00D961147S

(12) **United States Design Patent** (10) **Patent No.:** **US D961,147 S**  
**Li** (45) **Date of Patent:** **\*\* Aug. 16, 2022**

(54) **DESK LAMP**

FOREIGN PATENT DOCUMENTS

(71) Applicant: **SHENZHEN HONGWEI TRADING CO., LTD.**, Shenzhen (CN)

CN 202130588146.3 \* 2/2022

(72) Inventor: **Fengying Li**, Shenzhen (CN)

OTHER PUBLICATIONS

(73) Assignee: **SHENZHEN HONGWEI TRADING CO., LTD.**, Shenzhen (CN)

Amazon, "AXX LED Desk Lamp", first available Feb. 23, 2021. ([https://www.amazon.com/Holder-AXX-Light-Computer-Desktop/dp/B08SMNZWZ7/ref=psdc\\_1063292\\_t2\\_B094W2J438](https://www.amazon.com/Holder-AXX-Light-Computer-Desktop/dp/B08SMNZWZ7/ref=psdc_1063292_t2_B094W2J438)) (Year: 2021).\*

(\*\*) Term: **15 Years**

Amazon, "LED Desk Lamp with Wireless Charger, Sailstar", first available Sep. 6, 2021. (<https://www.amazon.com/dp/B09FJFM9H3/>) (Year: 2021).\*

(21) Appl. No.: **29/781,540**

Amazon, "Yonuos LED Desk Lamp", first available Dec. 16, 2021. (<https://www.amazon.com/dp/B09NPYZLCW/>) (Year: 2021).\*

(22) Filed: **Apr. 30, 2021**

Amazon, "Dunkok450LM Small Desk Lamp", first available Jan. 5, 2022. (<https://www.amazon.com/dp/B09HCD3R29/>) (Year: 2022).\*

(51) **LOC (13) Cl.** ..... **26-05**

(52) **U.S. Cl.**  
USPC ..... **D26/106**

\* cited by examiner

(58) **Field of Classification Search**  
USPC ..... D26/24, 58, 61, 63, 64, 65, 66, 93, 106  
CPC ..... F21L 2/00; F21L 4/00; F21L 4/02; F21L 4/025; F21L 4/027; F21L 14/00; F21S 2/00; F21S 8/03; F21S 8/033; F21S 6/00; F21S 6/002; F21S 8/036; F21S 8/037; H01K 7/00; H01K 7/02  
See application file for complete search history.

*Primary Examiner* — Lauren D McVey  
*Assistant Examiner* — Justin A Johnson

(57) **CLAIM**

The ornamental design for a desk lamp, as shown and described.

(56) **References Cited**

**DESCRIPTION**

U.S. PATENT DOCUMENTS

D176,550 S *	1/1956	Mugnai	.....	D26/109
D268,529 S *	4/1983	Lebowitz	.....	D26/65
D341,673 S *	11/1993	Yuen	.....	D26/65
D349,170 S *	7/1994	Lin	.....	D19/75
D423,136 S *	4/2000	Hsieh	.....	D26/107
6,279,753 B1 *	8/2001	Swanson	.....	G11B 33/0411
D702,761 S *	4/2014	Foley	.....	D19/77
D774,691 S *	12/2016	Akkad	.....	D26/142
D806,924 S *	1/2018	Gelman	.....	D26/62
D819,127 S *	5/2018	Walker	.....	D26/65
D822,879 S	7/2018	Hodgson		
D882,858 S *	4/2020	Sun	.....	D26/107
D892,390 S	8/2020	Tong		
D913,572 S *	3/2021	Qinwen	.....	D26/106
D914,955 S *	3/2021	Deng	.....	D26/107

FIG. 1 is a perspective view of a desk lamp showing my new design;  
FIG. 2 is another perspective view thereof;  
FIG. 3 is a front elevational view thereof;  
FIG. 4 is a rear elevational view thereof;  
FIG. 5 is a left side elevational view thereof;  
FIG. 6 is a right side elevational view thereof;  
FIG. 7 is a top plan view thereof; and,  
FIG. 8 is a bottom plan view thereof.  
The broken lines in the drawings depict portions of the desk lamp that form no part of the claimed design.

**1 Claim, 8 Drawing Sheets**

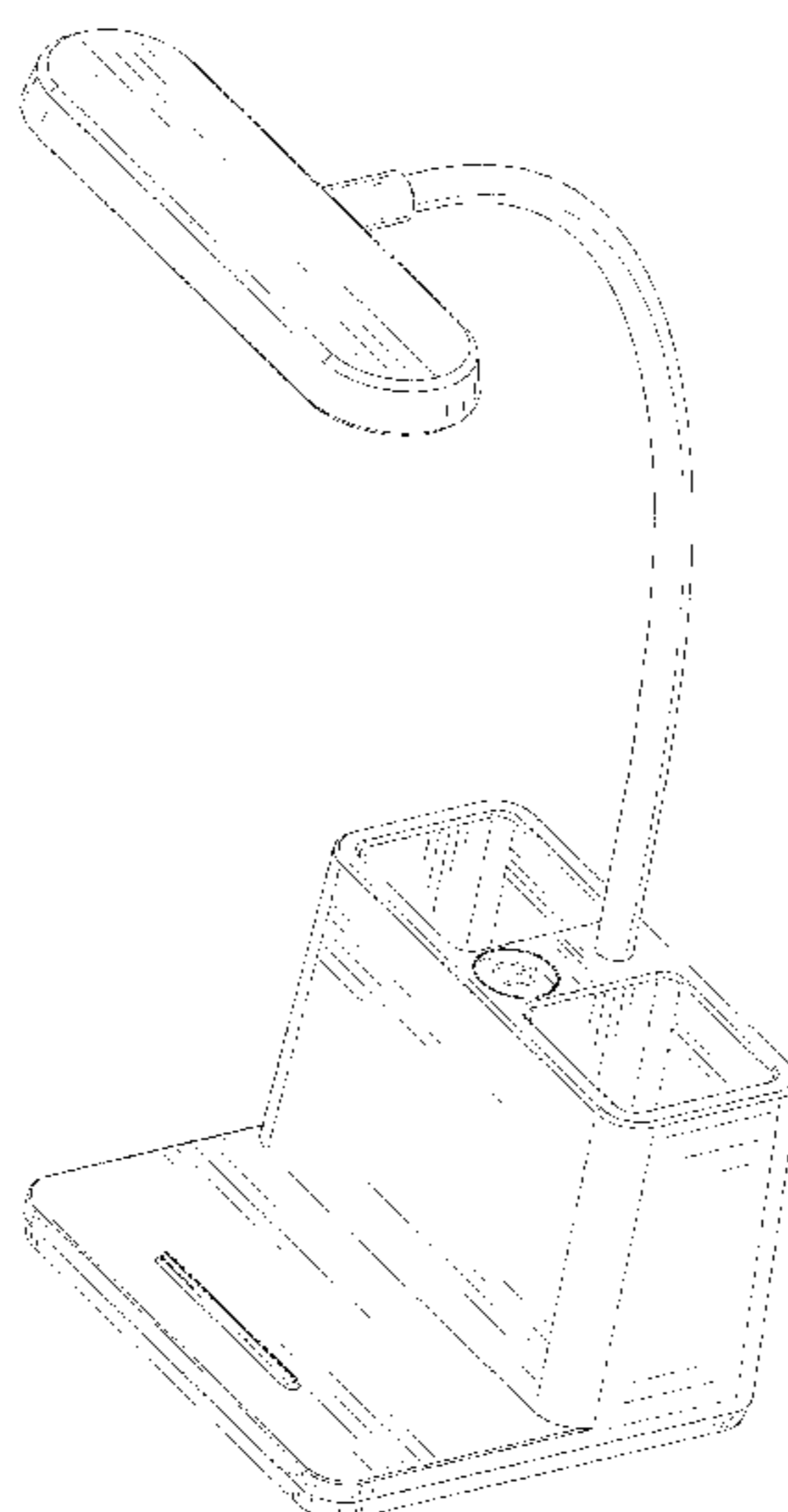

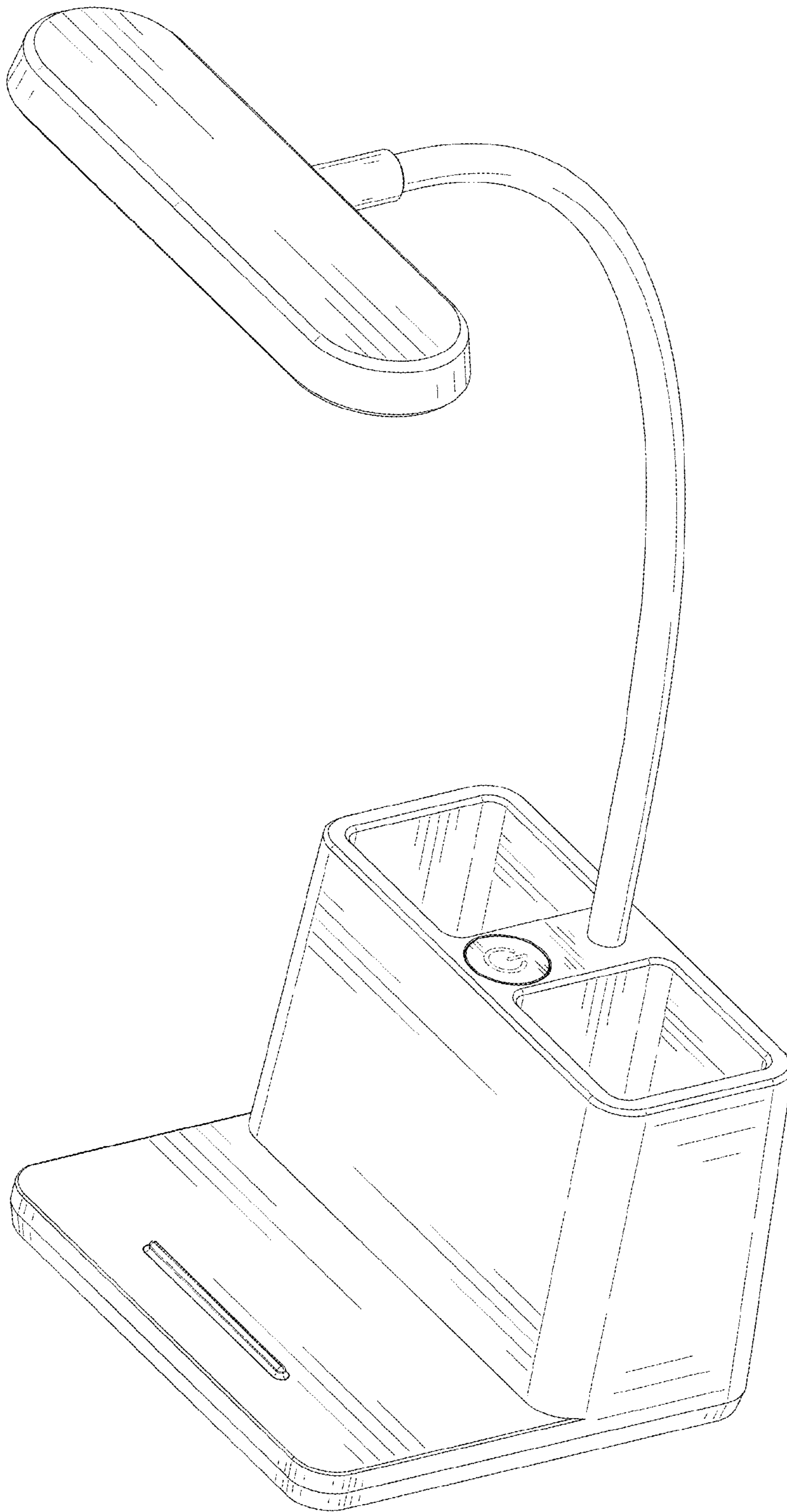

FIG. 1

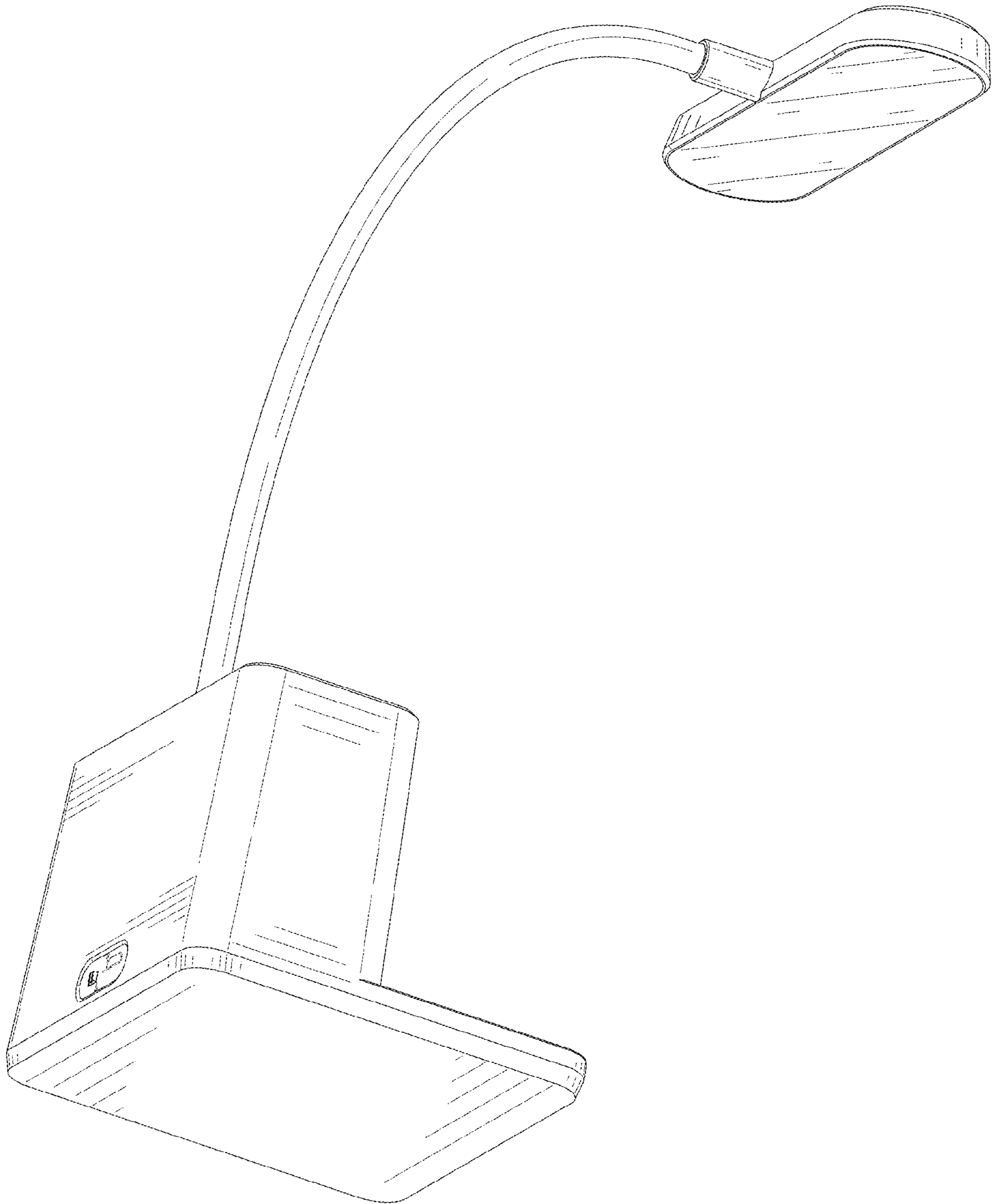

FIG. 2

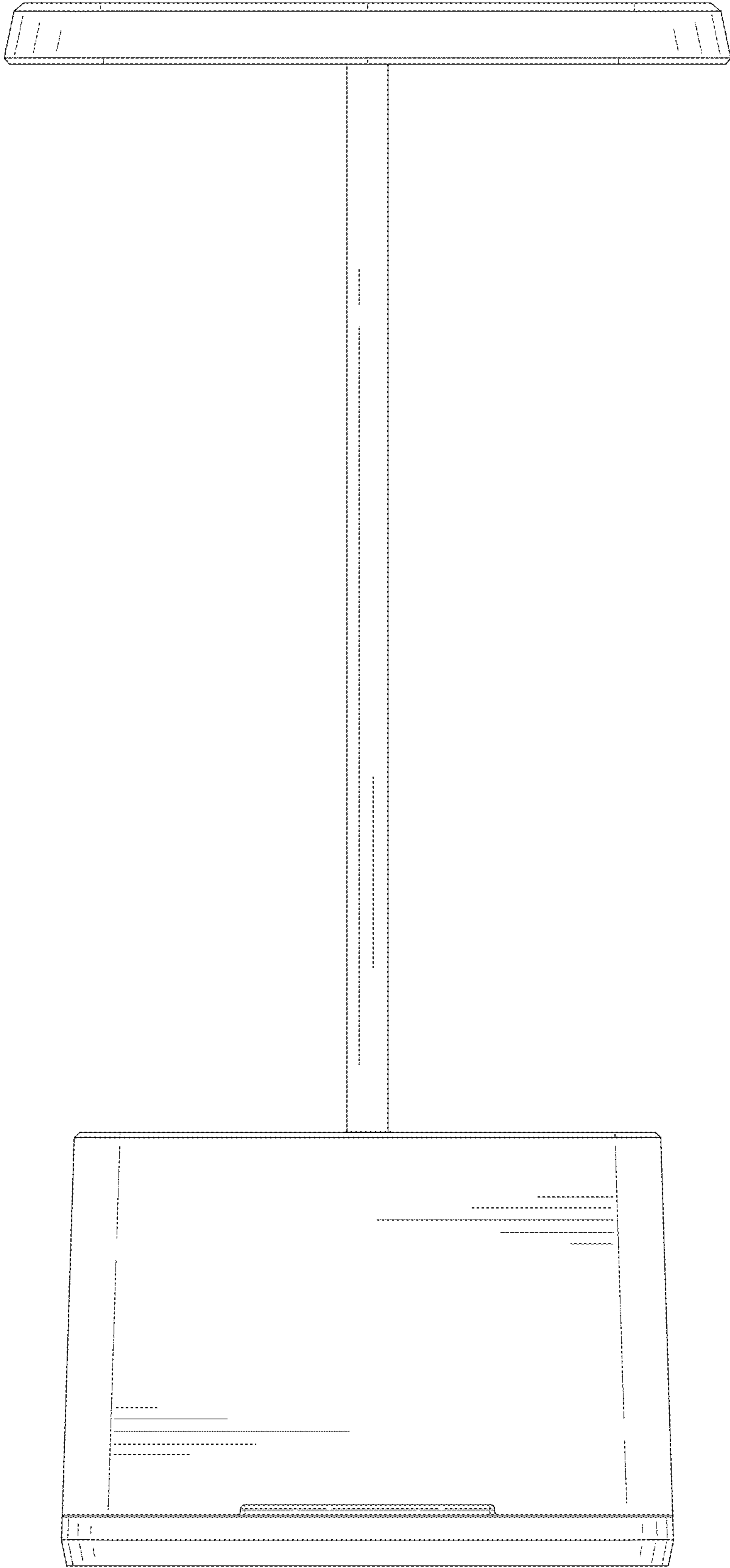

FIG. 3

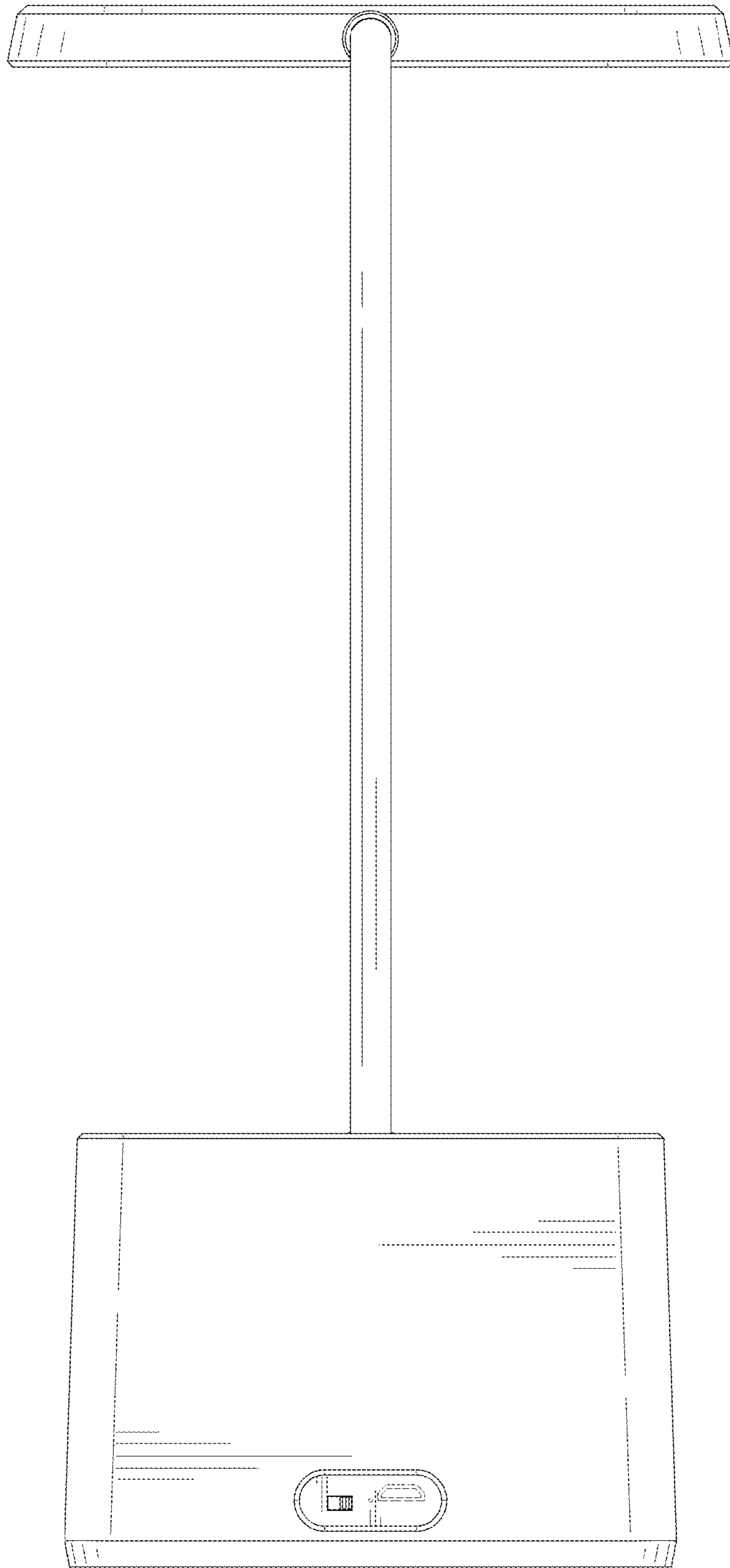

FIG. 4

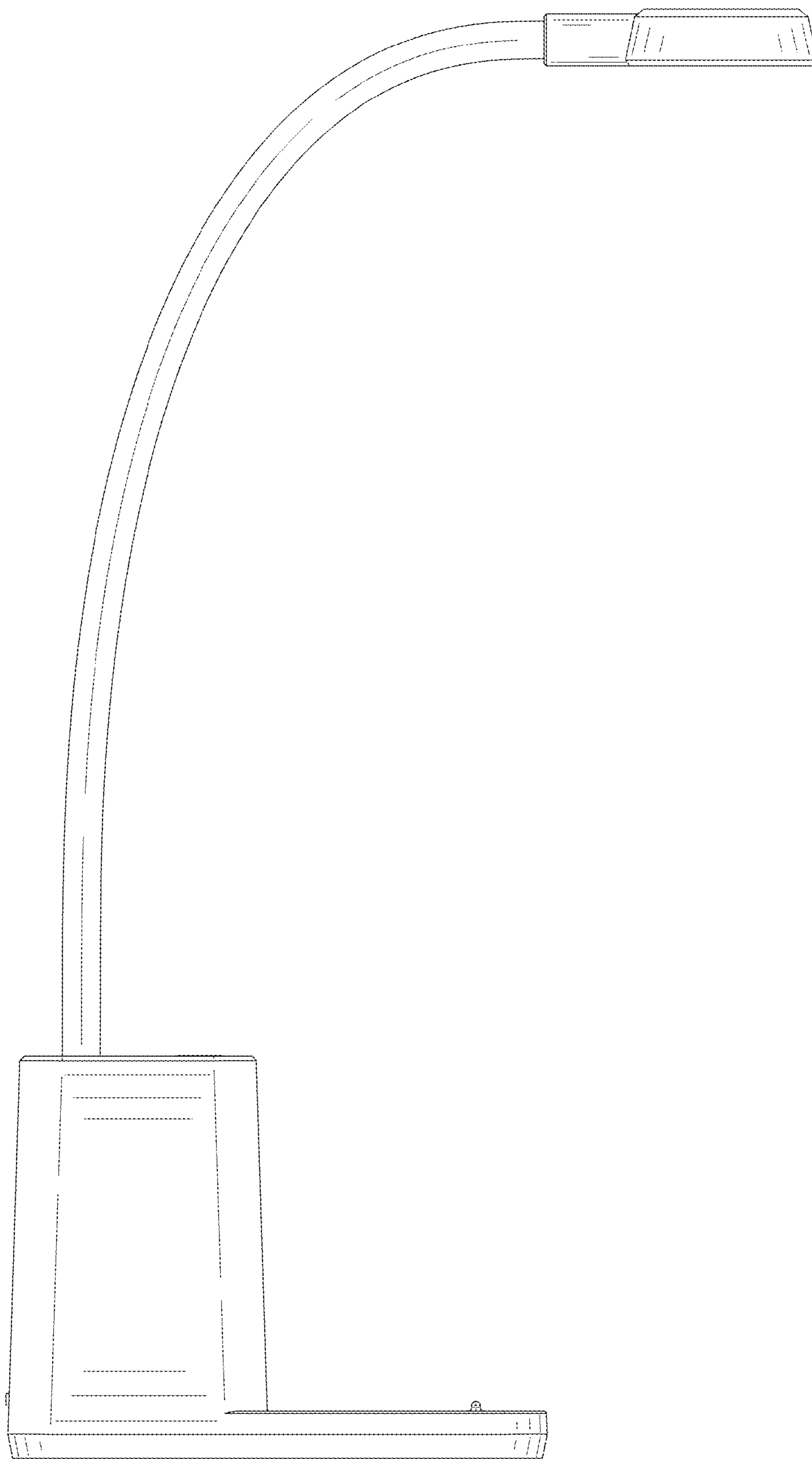

FIG. 5

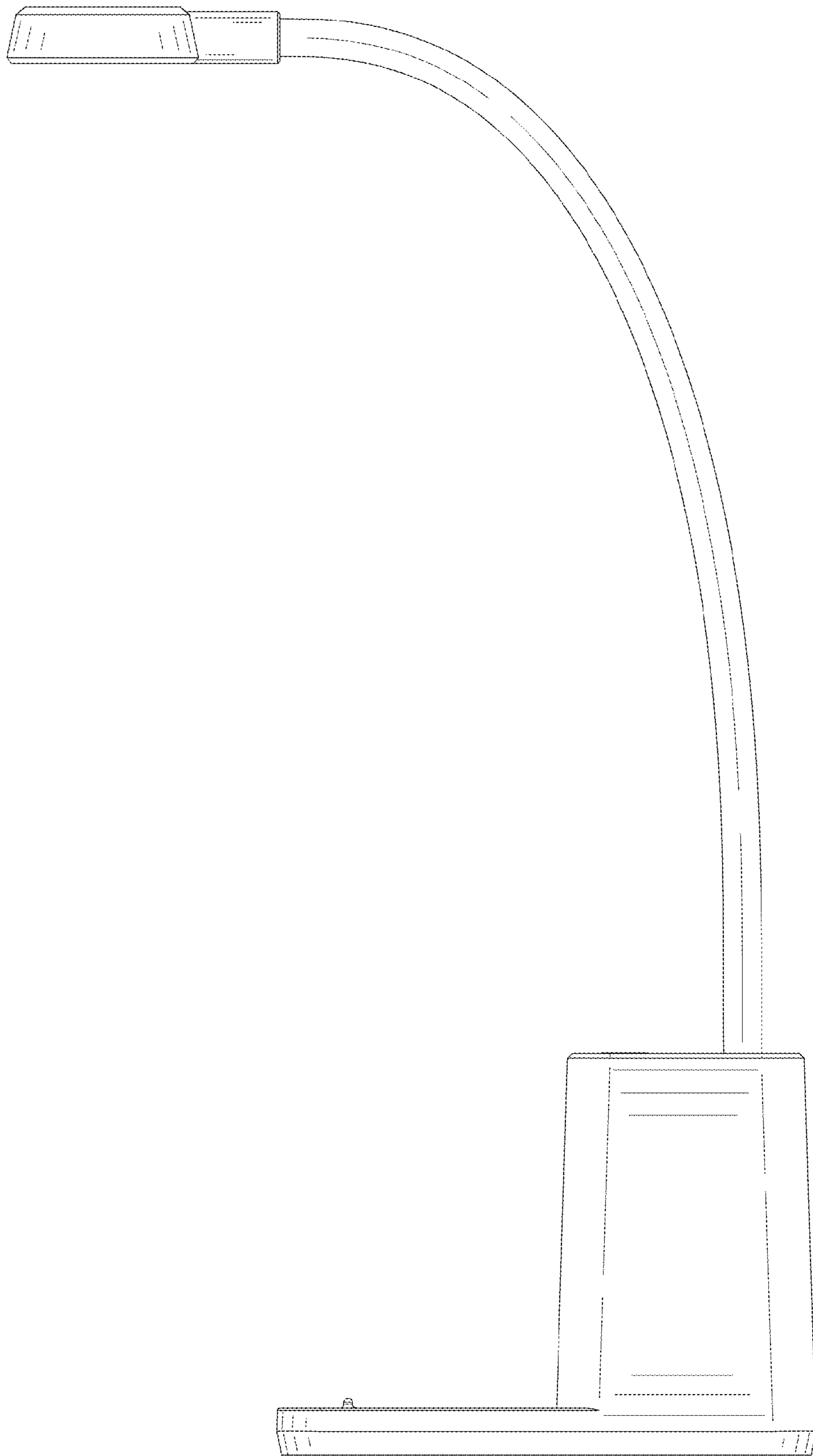

FIG. 6

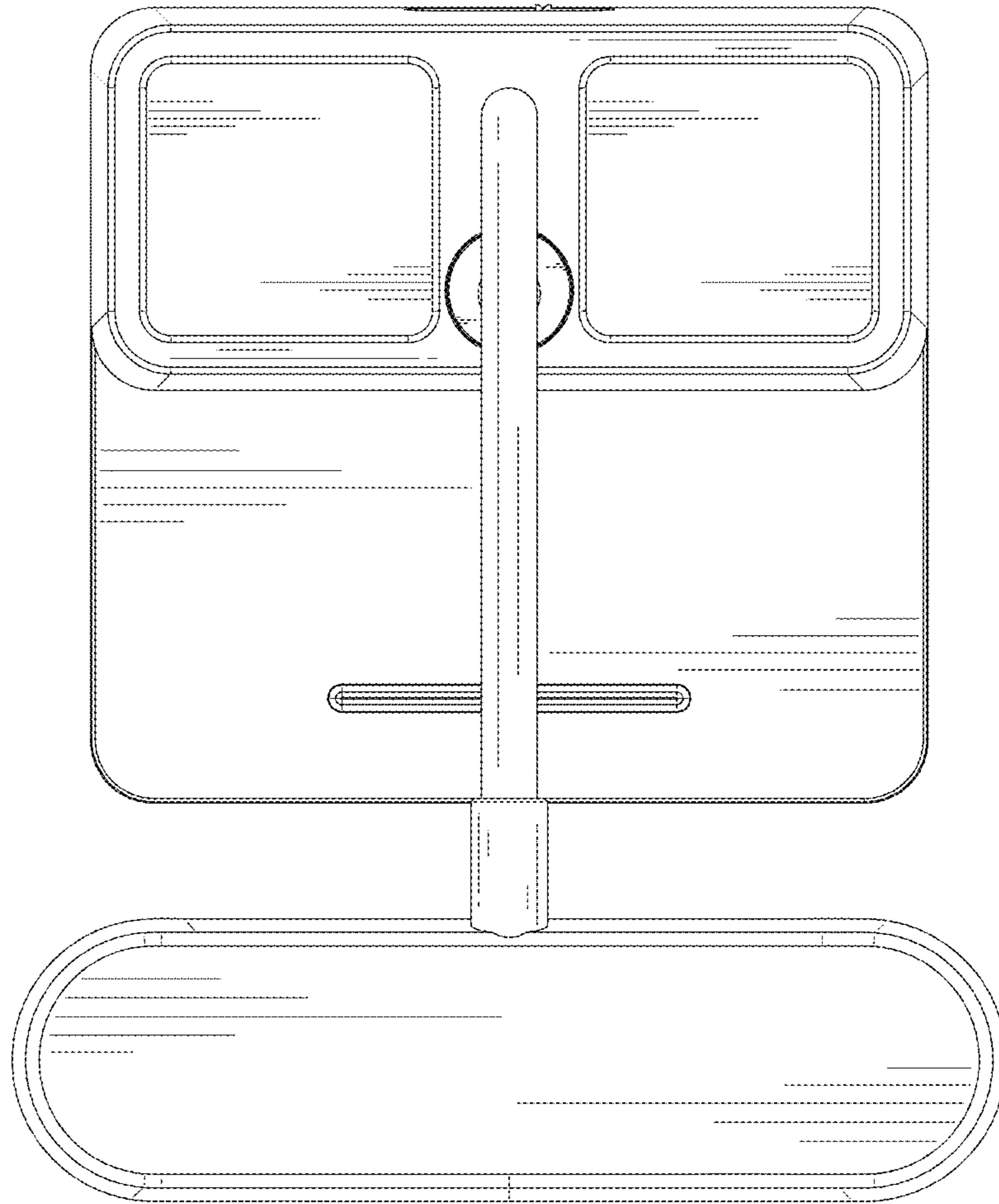

FIG. 7



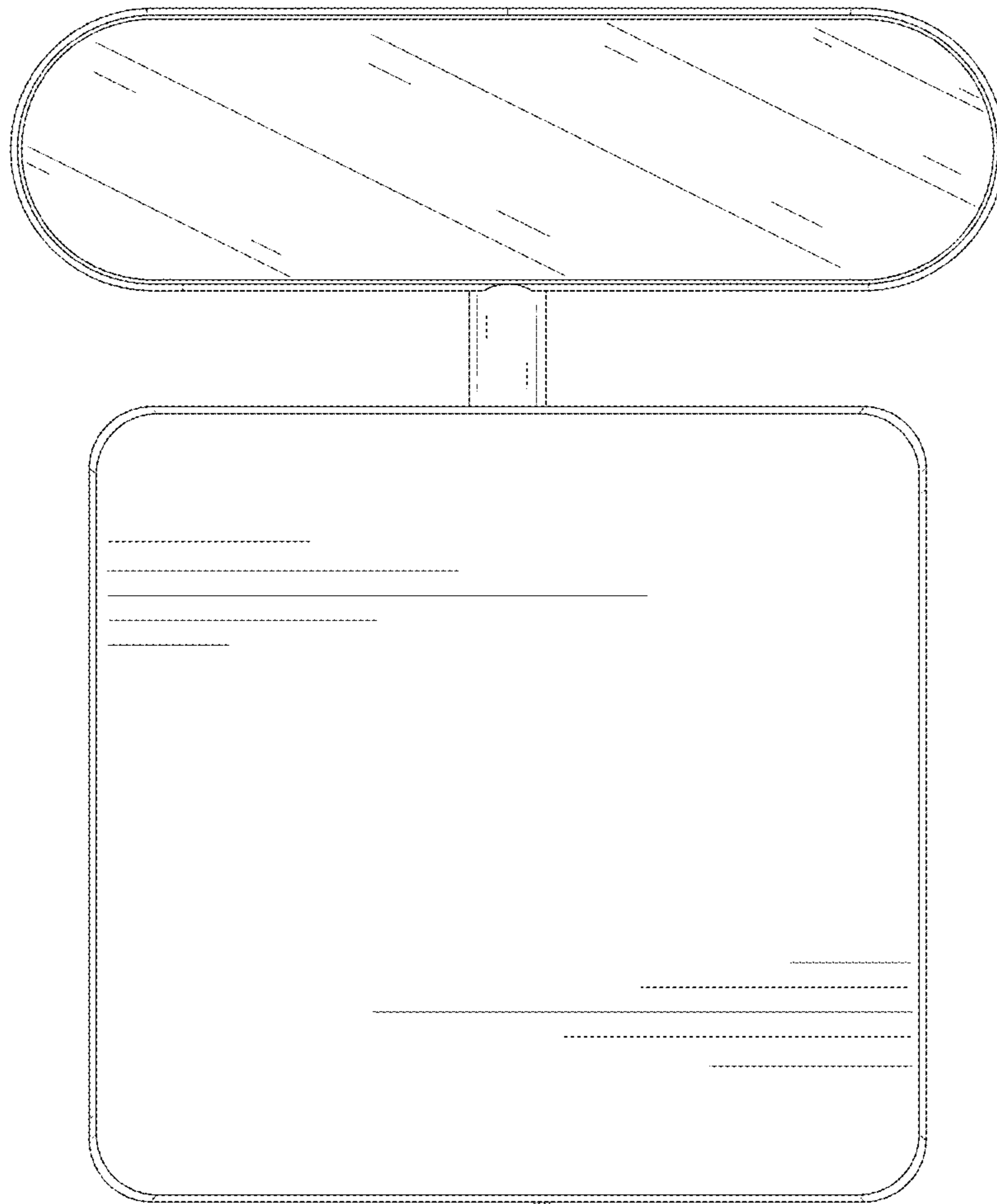

FIG. 8