



US00D961088S

(12) **United States Design Patent** (10) **Patent No.:** **US D961,088 S**
Christiansen (45) **Date of Patent:** **** Aug. 16, 2022**

(54) **HEARING AIDS**

(71) Applicant: **GN Hearing A/S**, Ballerup (DK)

(72) Inventor: **Henrik Hetz Christiansen**,
DK-Copenhagen K (DK)

(73) Assignee: **GN HEARING A/S**, Ballerup (DK)

(**) Term: **15 Years**

(21) Appl. No.: **35/509,894**

(22) Filed: **Jun. 22, 2020**

(80) **Hague Agreement Data**
Int. Filing Date: **Jun. 22, 2020**
Int. Reg. No.: **DM/209307**
Int. Reg. Date: **Jun. 22, 2020**
Int. Reg. Pub. Date: **Jul. 24, 2020**

(51) **LOC (13) Cl.** **24-99**

(52) **U.S. Cl.**
USPC **D24/174**

(58) **Field of Classification Search**
USPC D24/173; D14/205, 226
CPC ... H04R 2225/025; H04R 25/60; H04R 25/65
See application file for complete search history.

(56) **References Cited**
U.S. PATENT DOCUMENTS

D676,968 S * 2/2013 Meinertz D24/174
D698,025 S * 1/2014 Jensen D24/174
D720,460 S * 12/2014 Jensen D24/174
D762,305 S * 7/2016 Gabathuler D24/174
D805,203 S * 12/2017 Meinertz D24/174
D806,252 S * 12/2017 Lockenwitz D24/174
D837,984 S * 1/2019 Christiansen D24/151
D851,770 S * 6/2019 Christiansen D24/174

D852,363 S * 6/2019 Christiansen D24/174
D853,568 S * 7/2019 Christiansen D24/174
D861,171 S * 9/2019 Christiansen D24/174
D872,280 S * 1/2020 Shi D24/174

* cited by examiner

Primary Examiner — Calvin E Vansant
(74) *Attorney, Agent, or Firm* — Vista IP Law Group,
LLP

(57) **CLAIM**

The ornamental design for hearing aids, as shown and described.

DESCRIPTION

1. 3. 5. Hearing aids

1.1 : Perspective

1.2 : Left

1.3 : Right

1.4 : Bottom

1.5 : Top

1.6 : Front

3.1 : Perspective

3.2 : Left

3.3 : Right

3.4 : Bottom

3.5 : Top

3.6 : Front

3.7 : Back

5.1 : Perspective

5.2 : Left

5.3 : Right

5.4 : Bottom

5.5 : Top

5.6 : Front

5.7 : Back

The portions of the hearing aids shown in broken lines form no part of the claimed design.

1 Claim, 21 Drawing Sheets

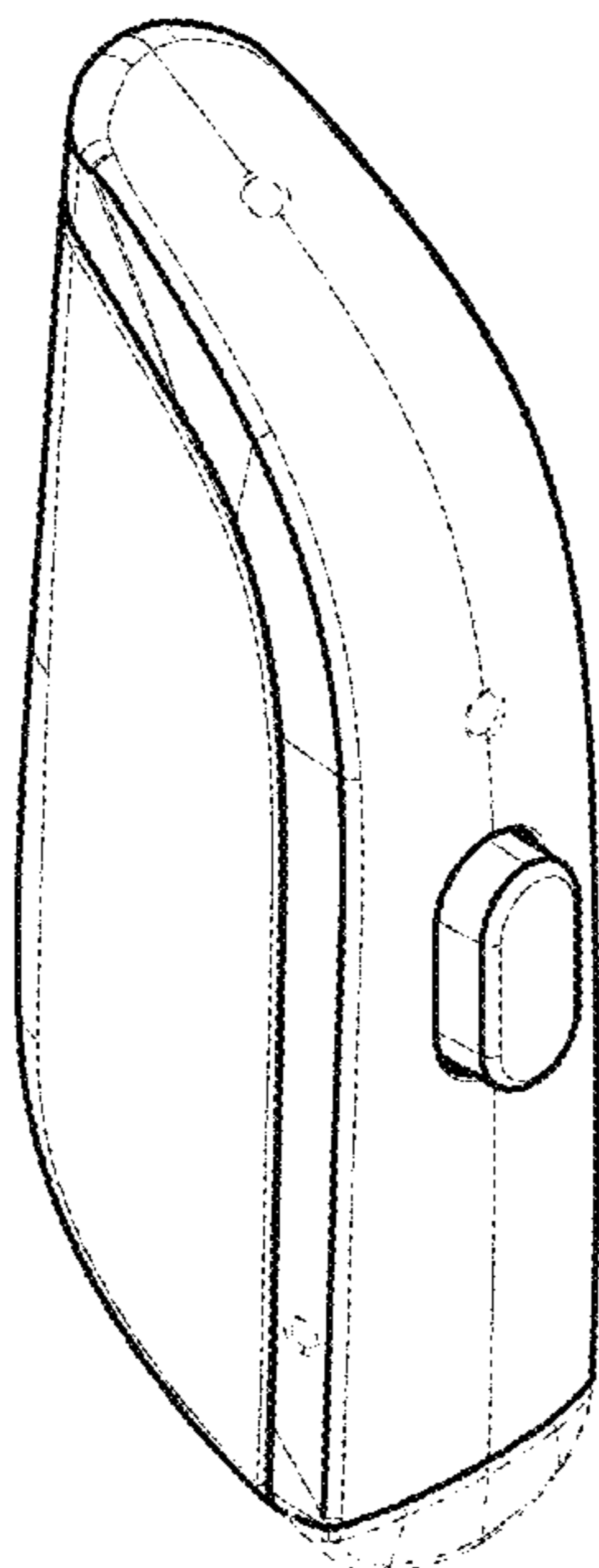

1.1

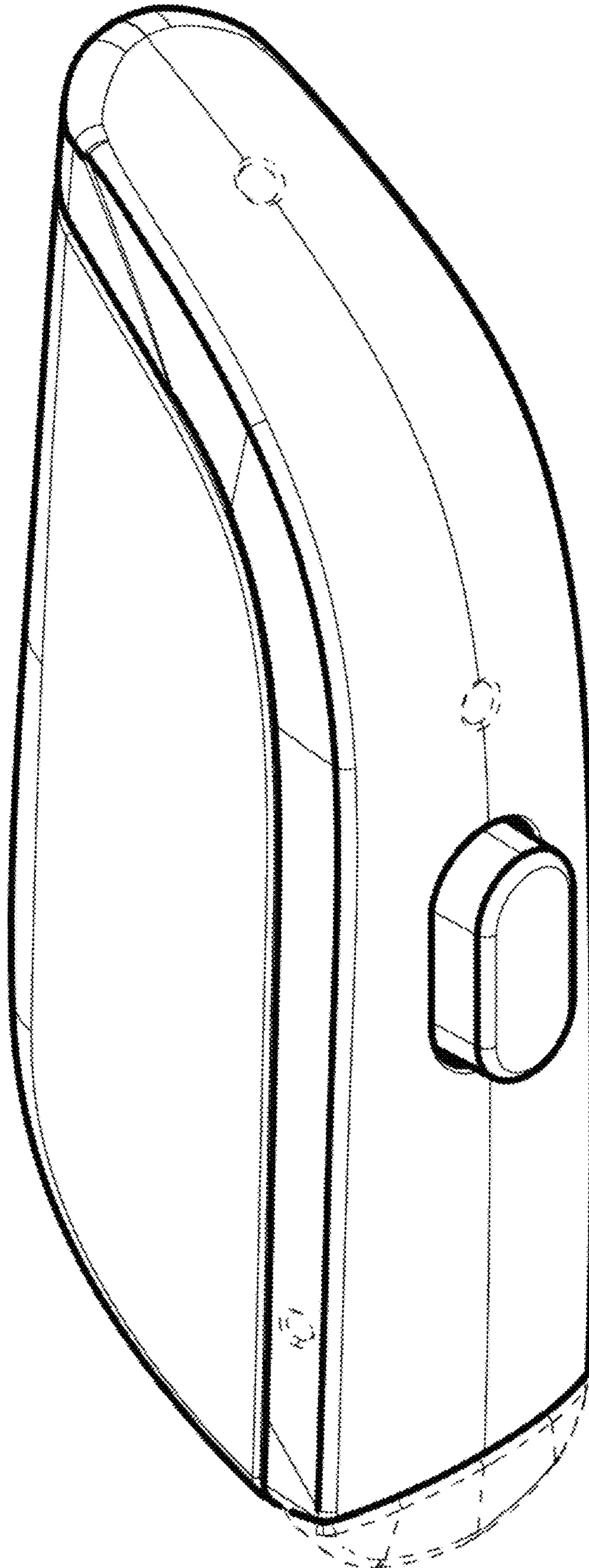

1.2

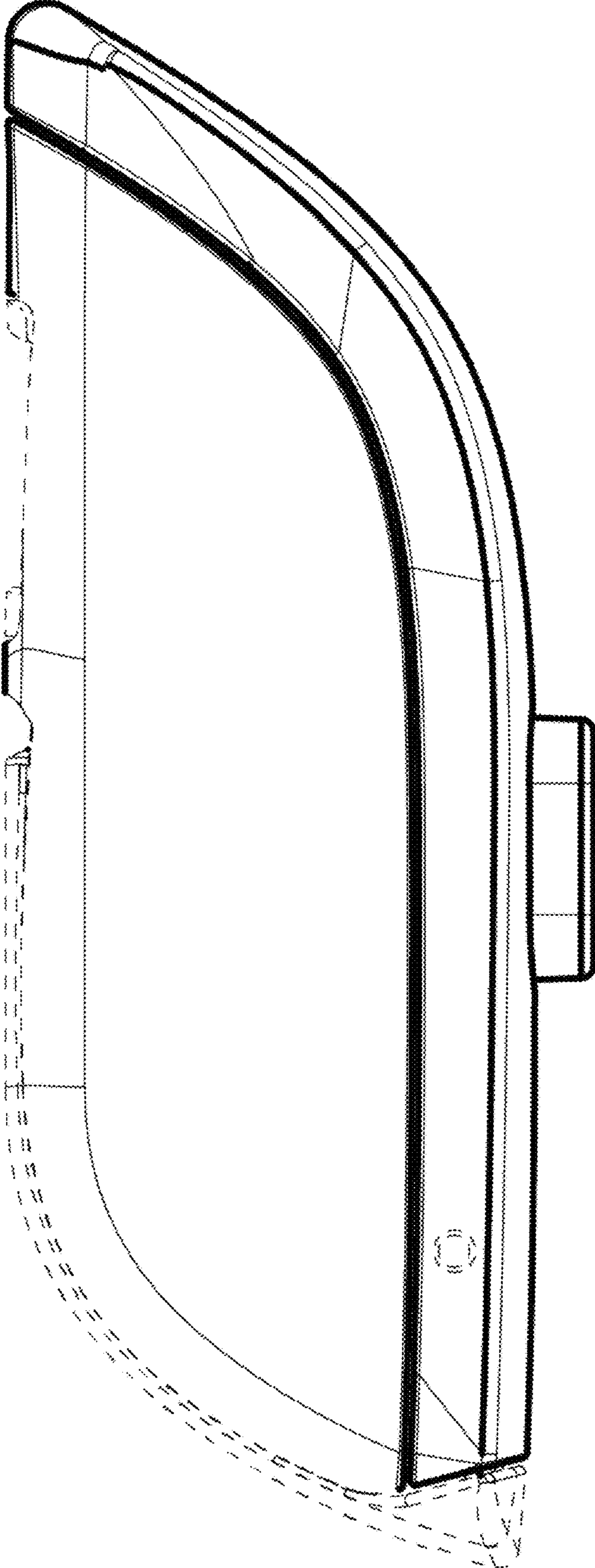

1.3

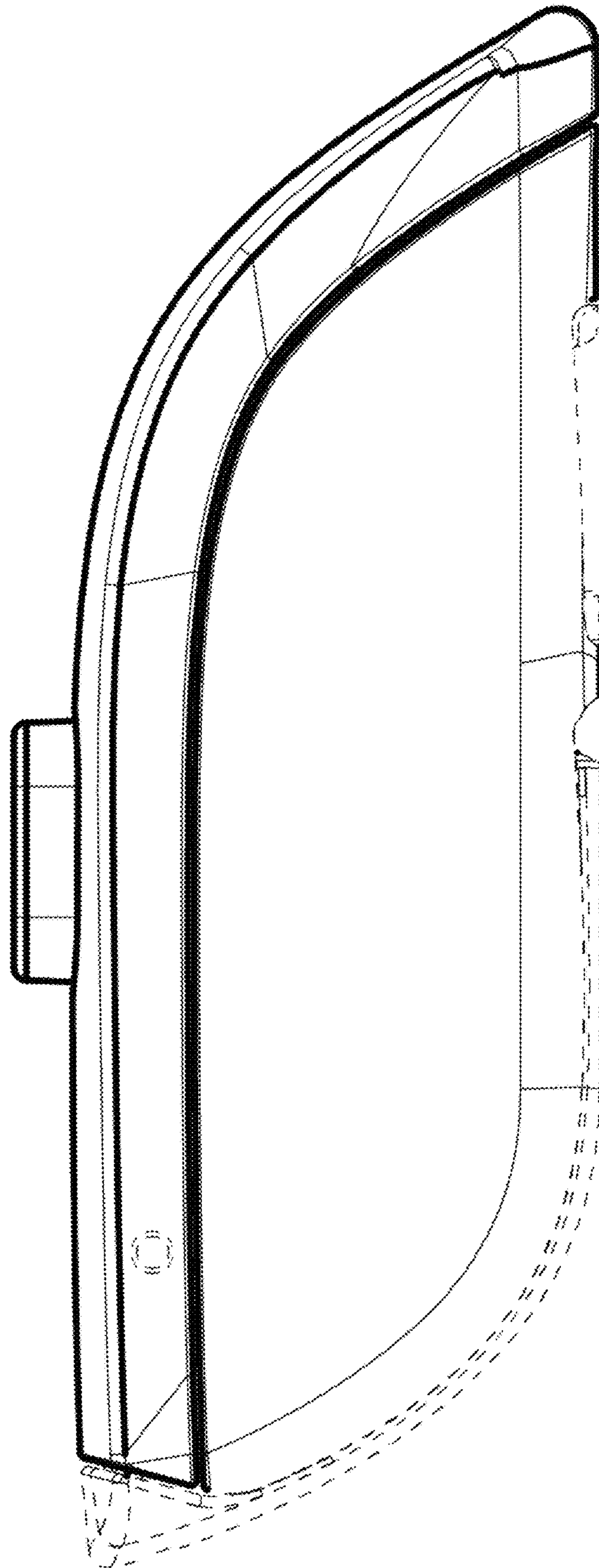

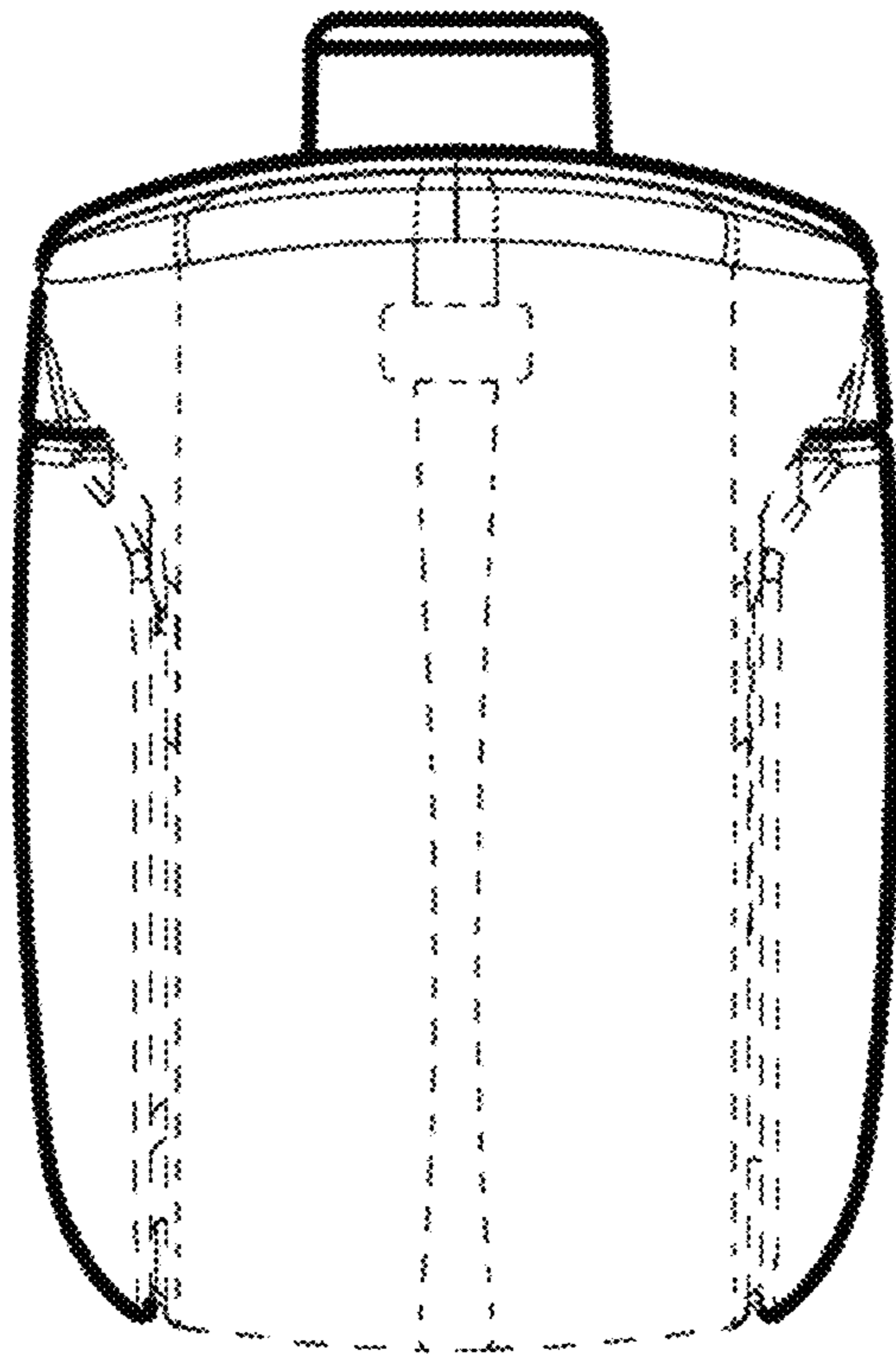
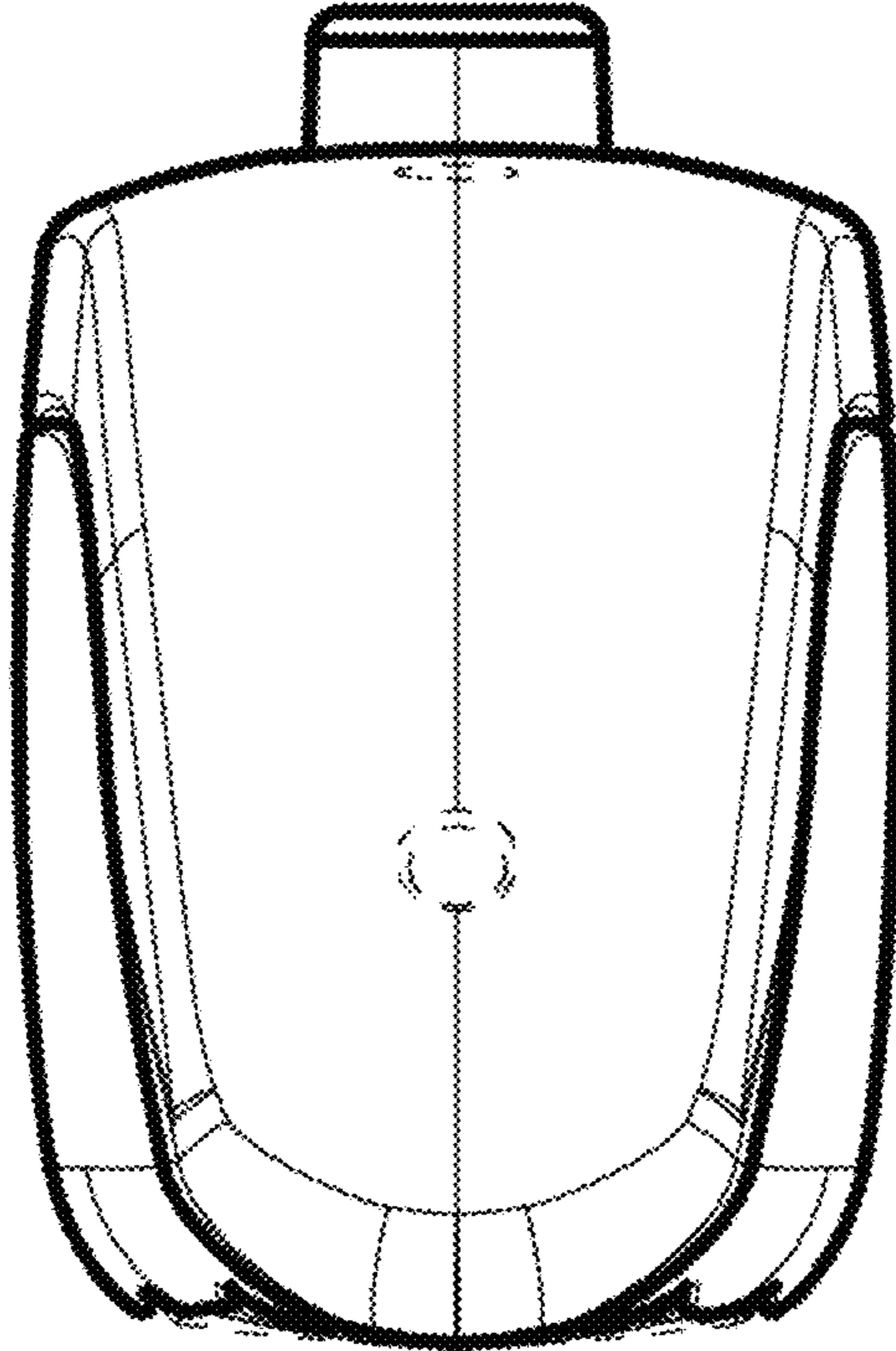
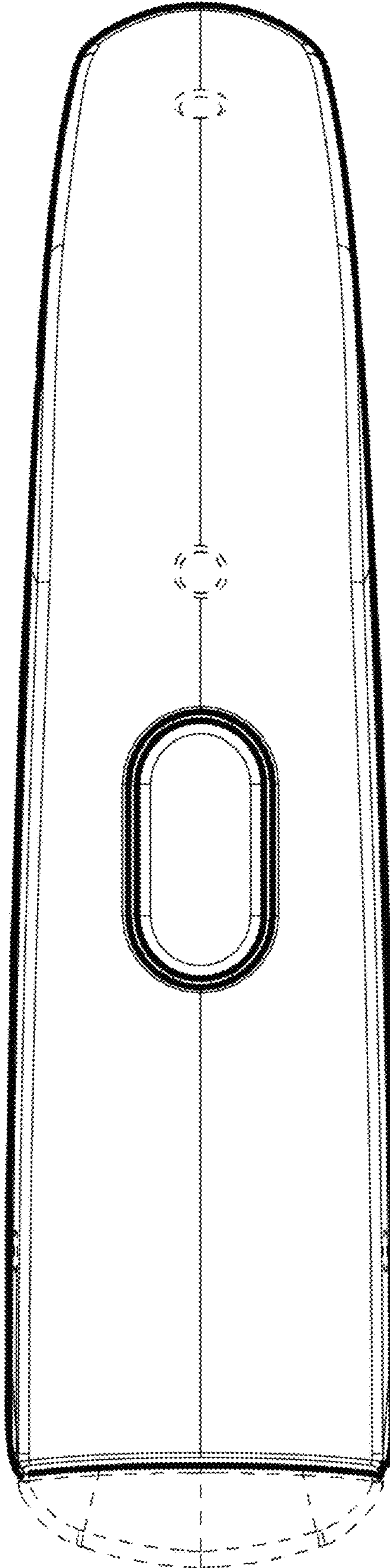

FIG. 1.4

1.5



1.6



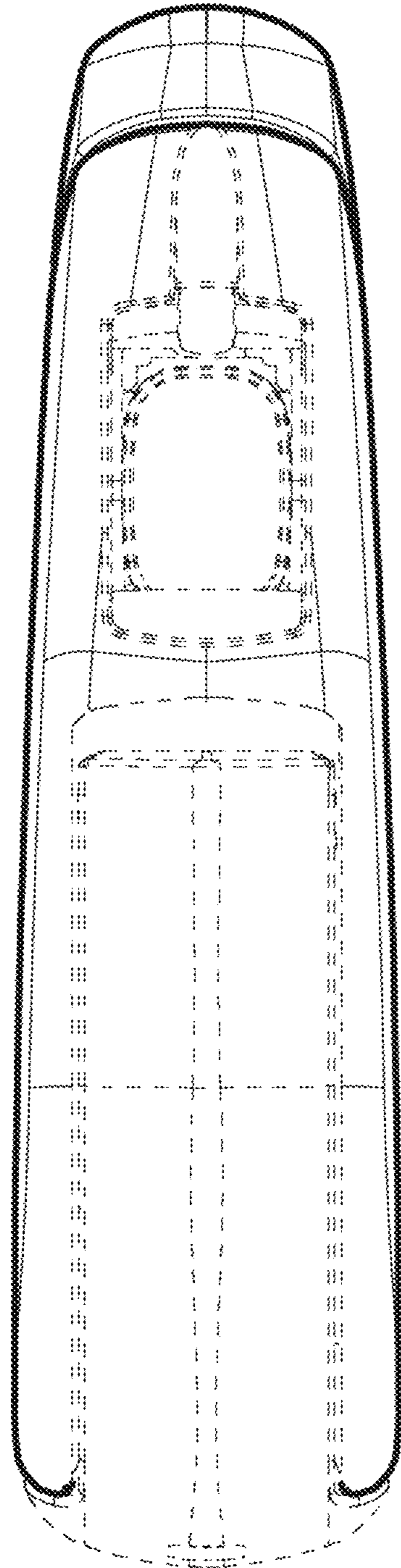
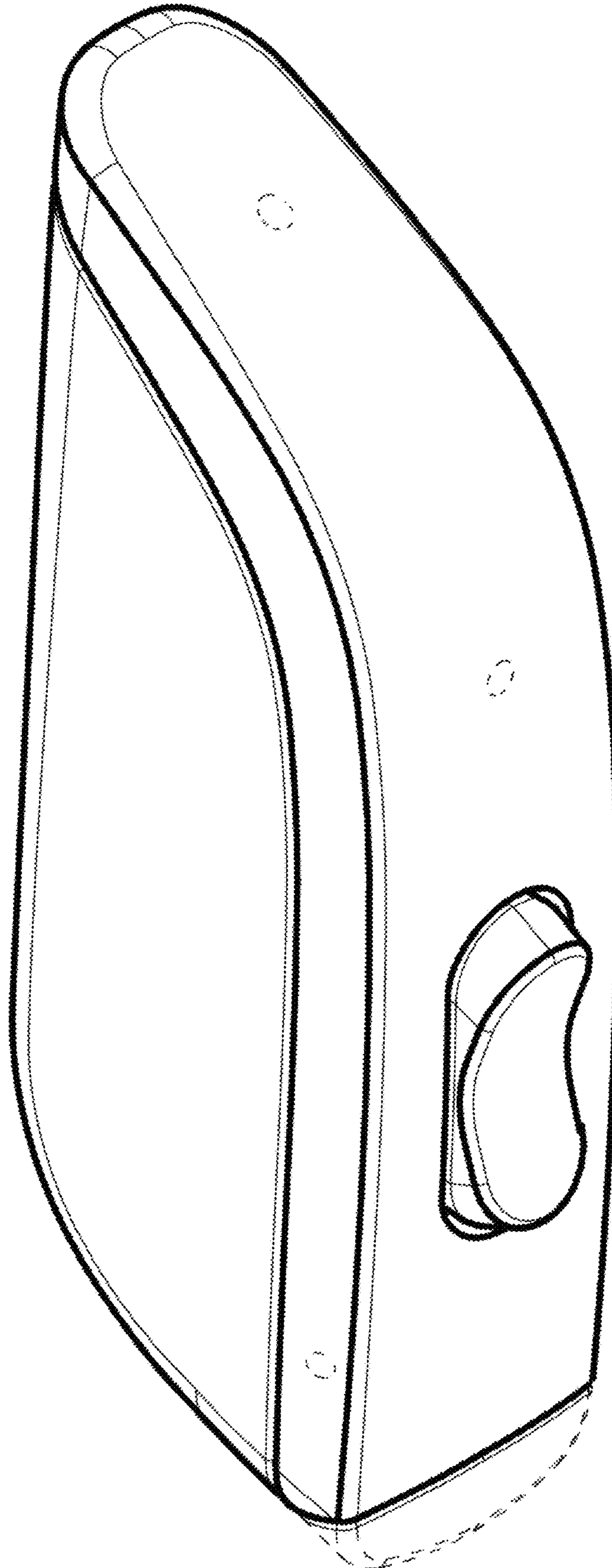
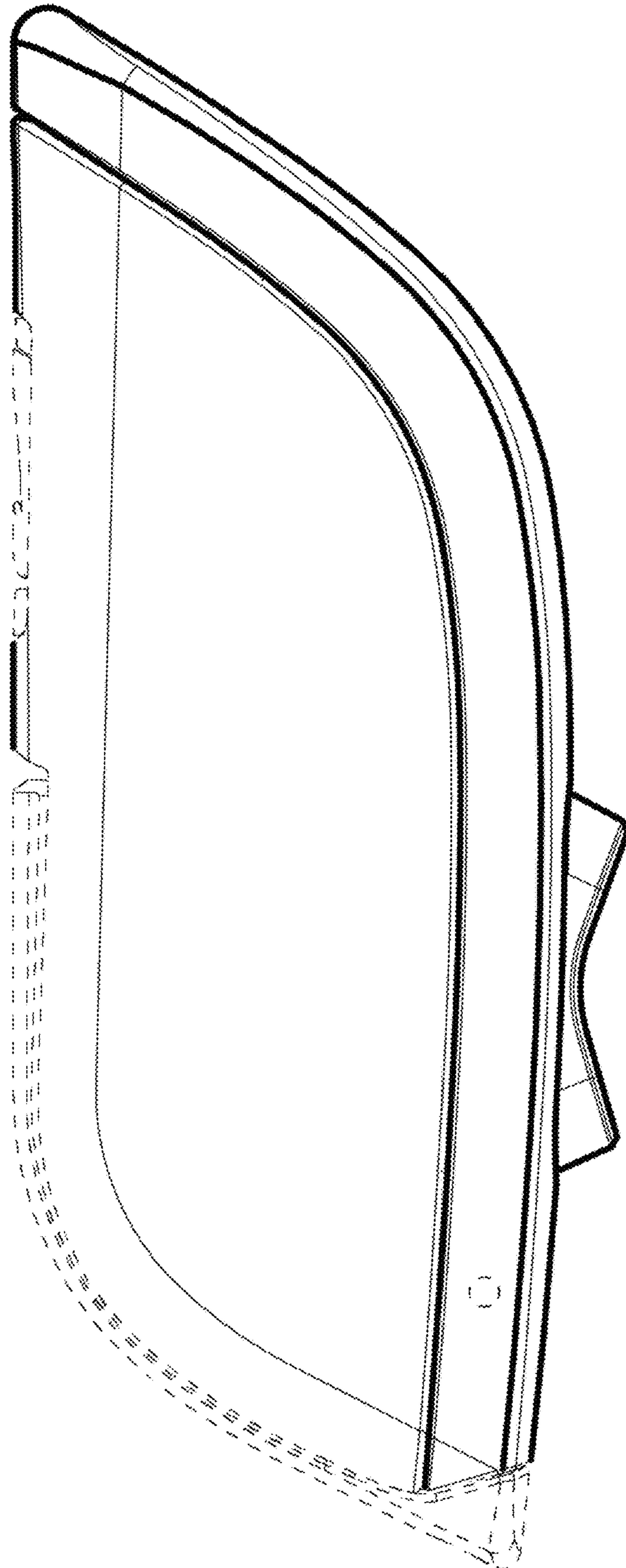

FIG. 1.7

3.1



3.2



3.3

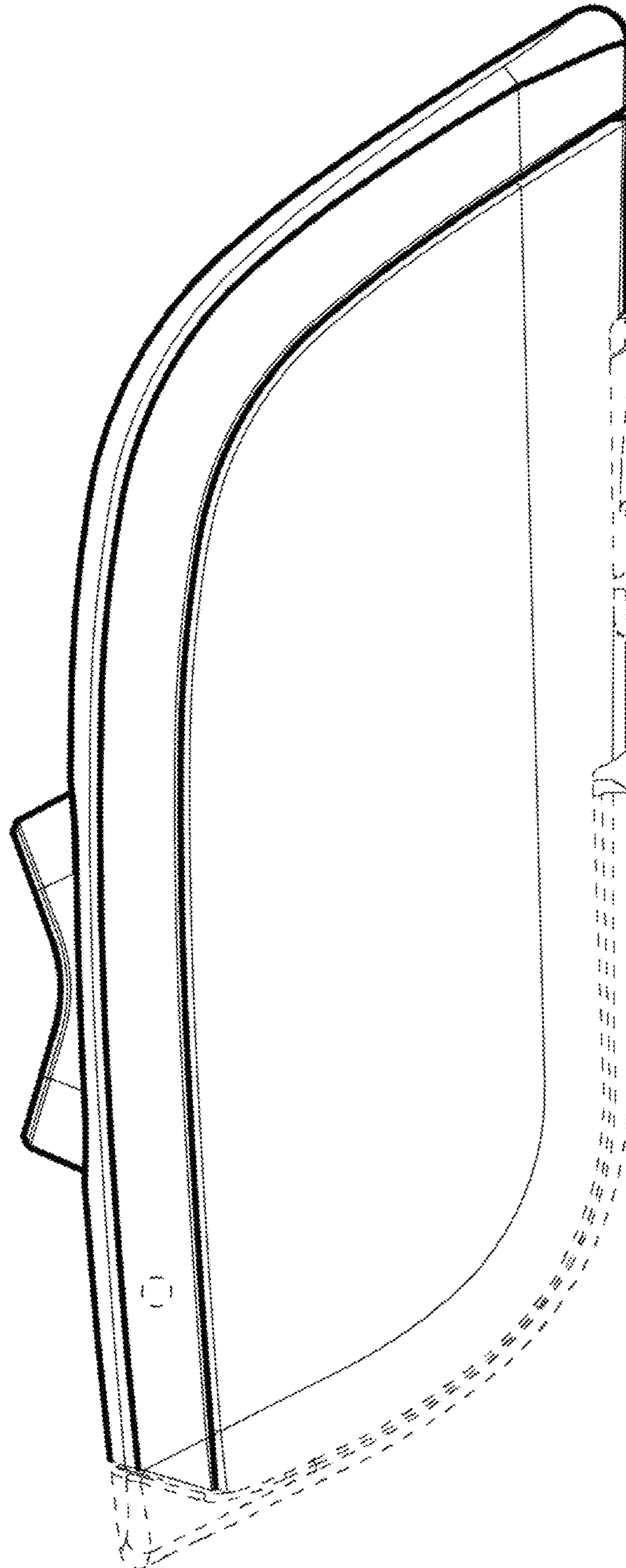

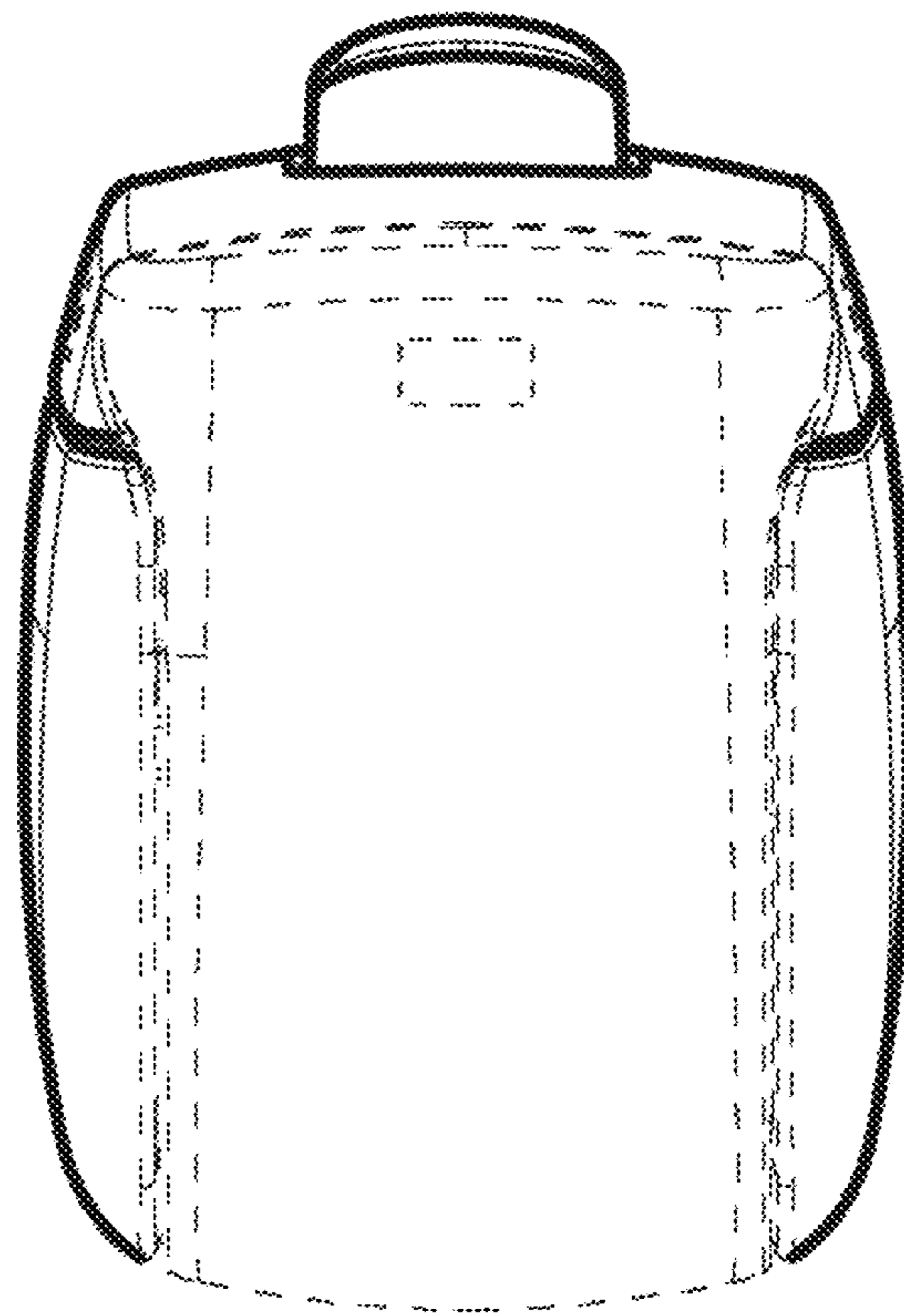
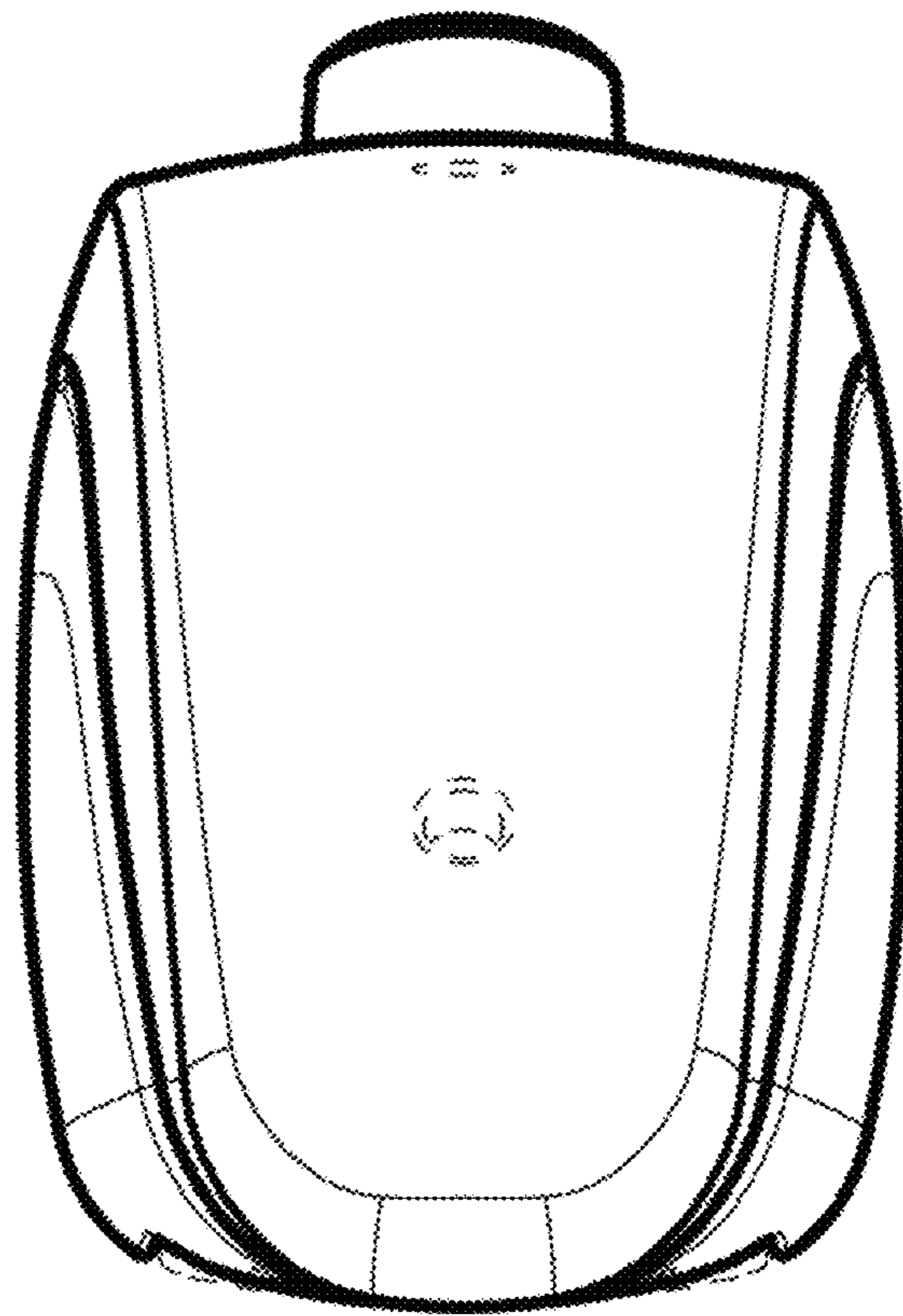
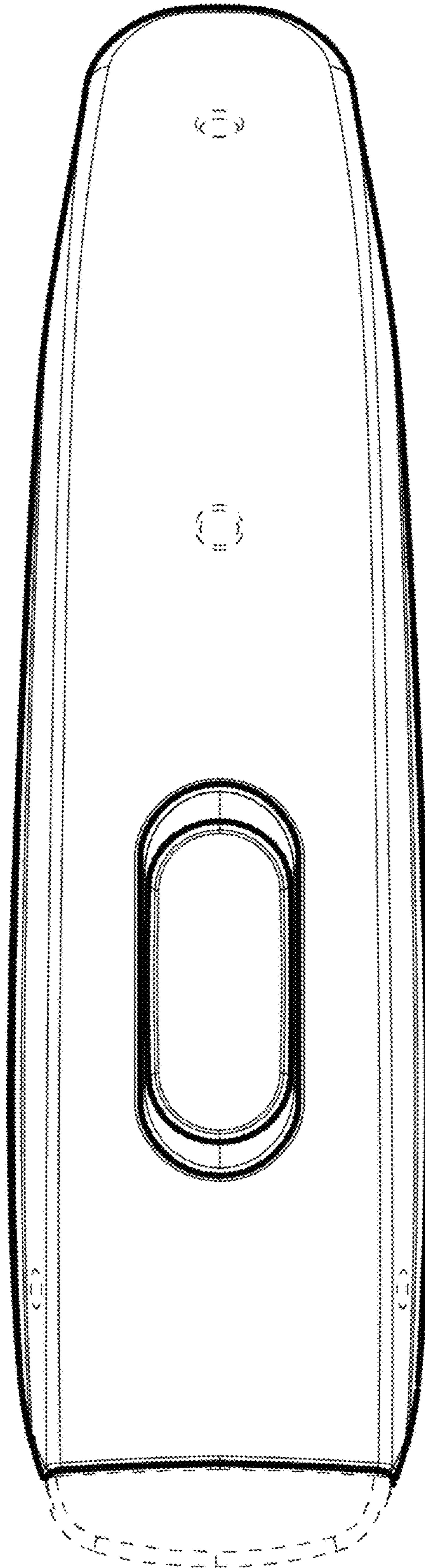

FIG. 3.4

3.5



3.6



3.7

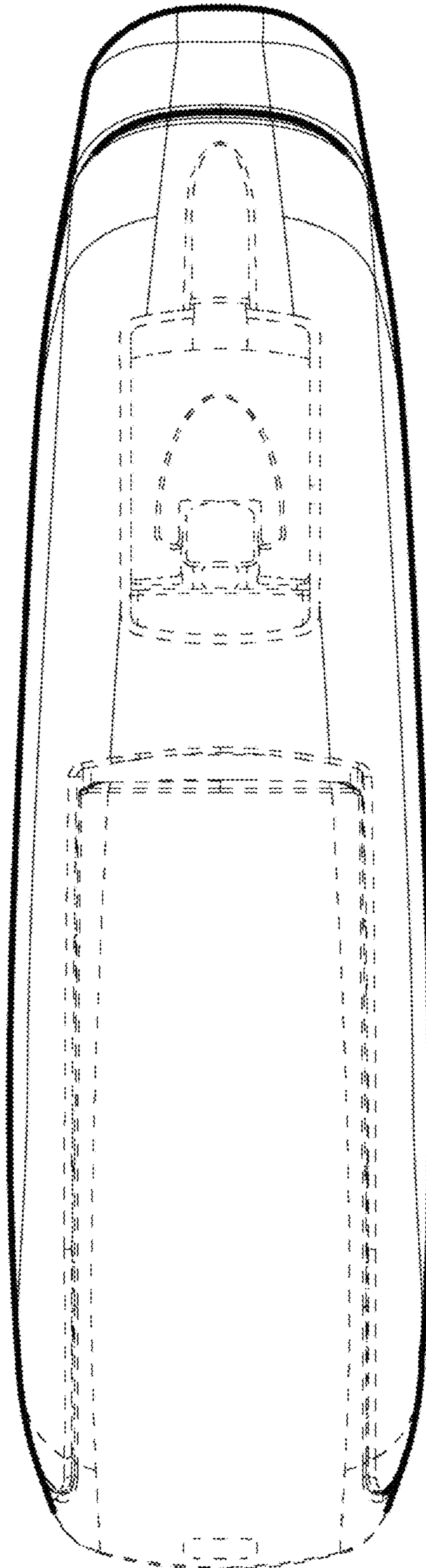

5.1

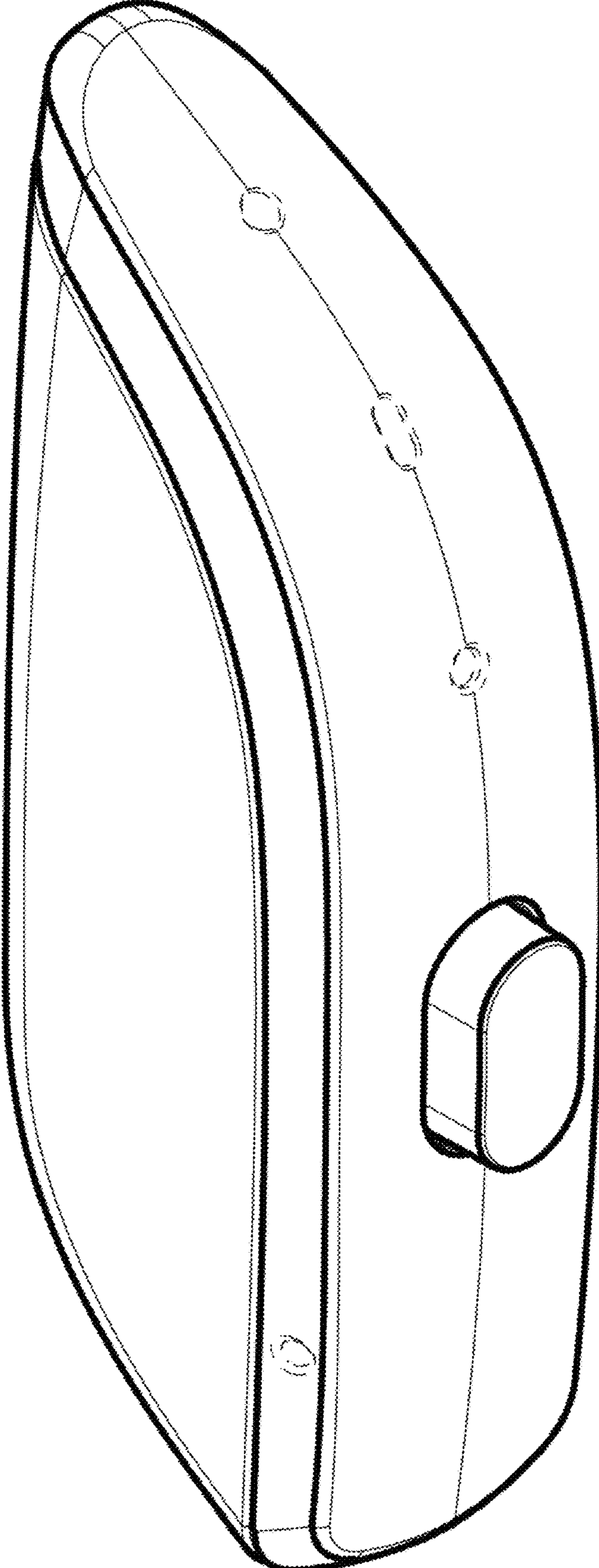

5.2

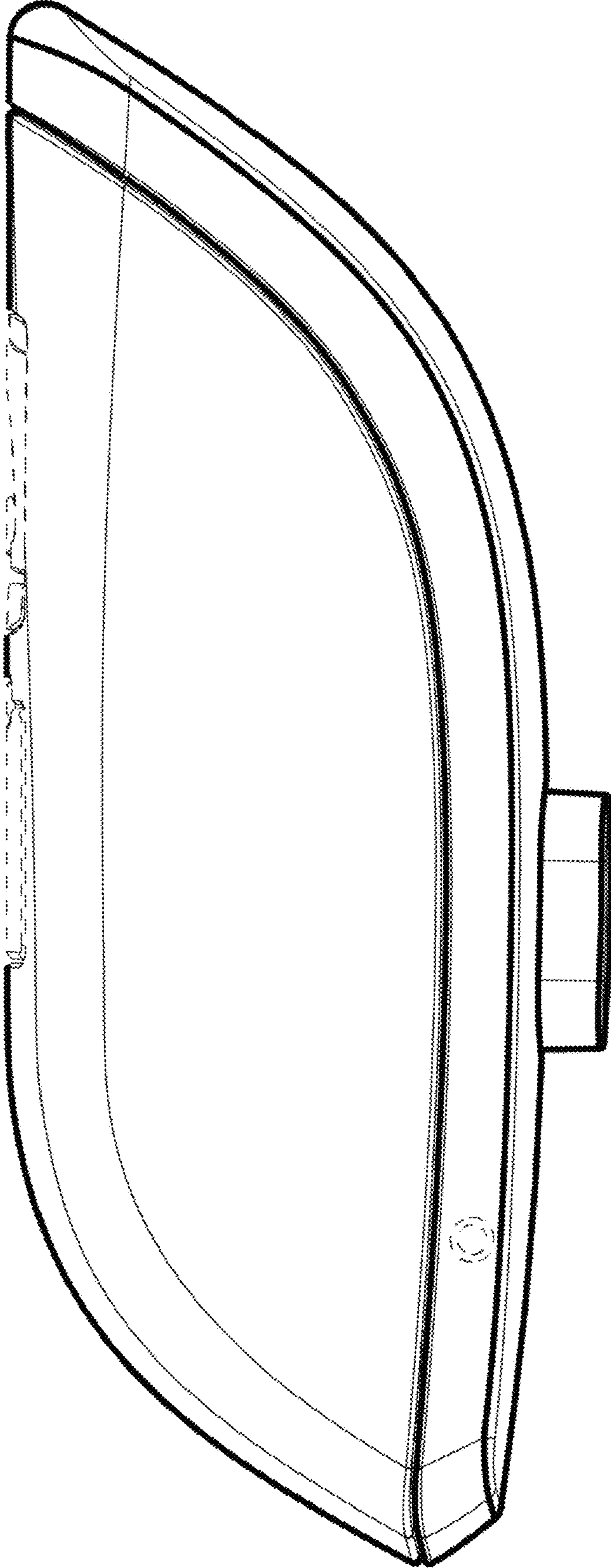

5.3

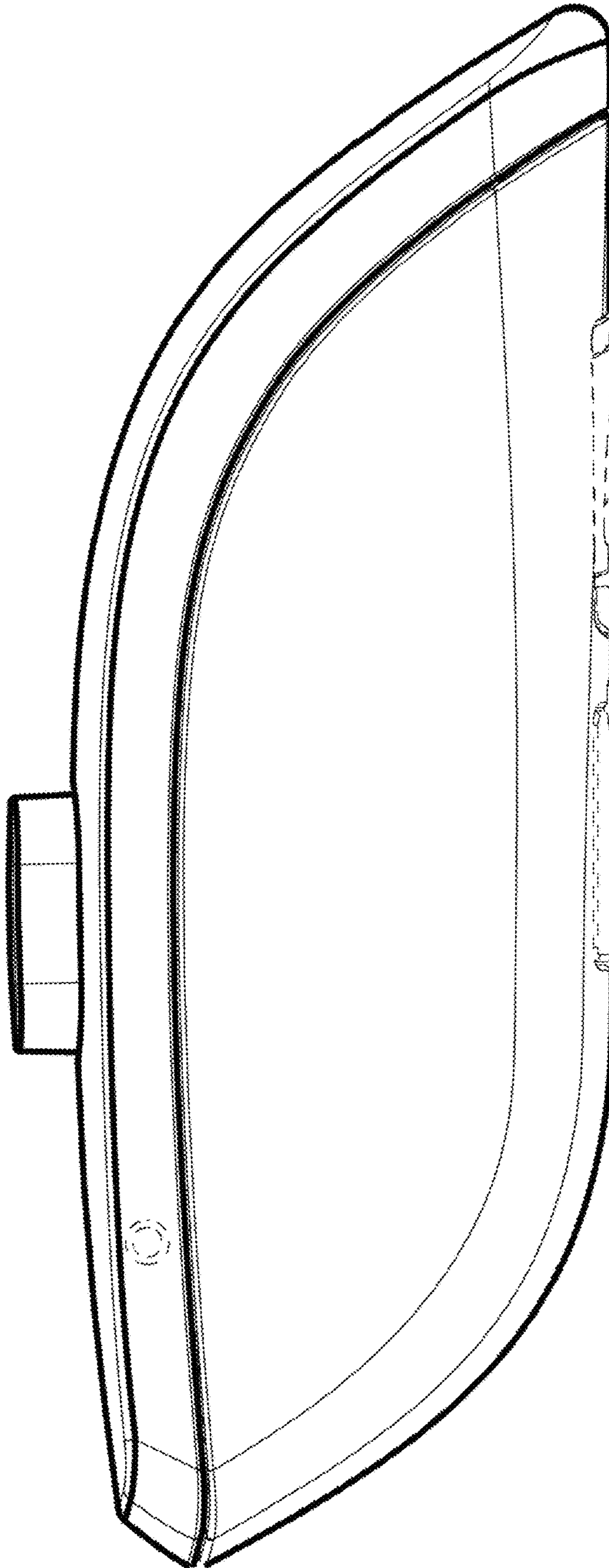

5.4

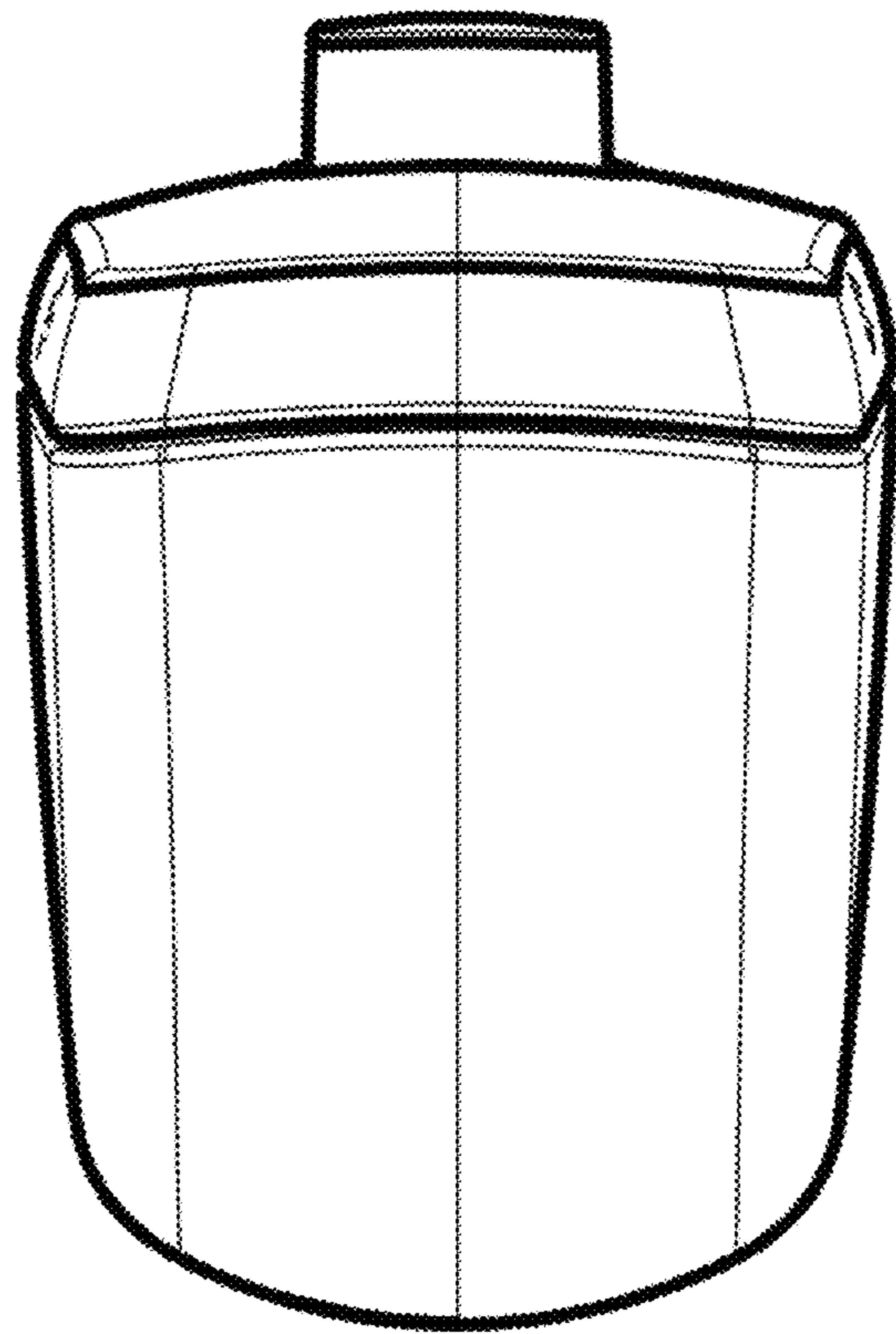

5.5

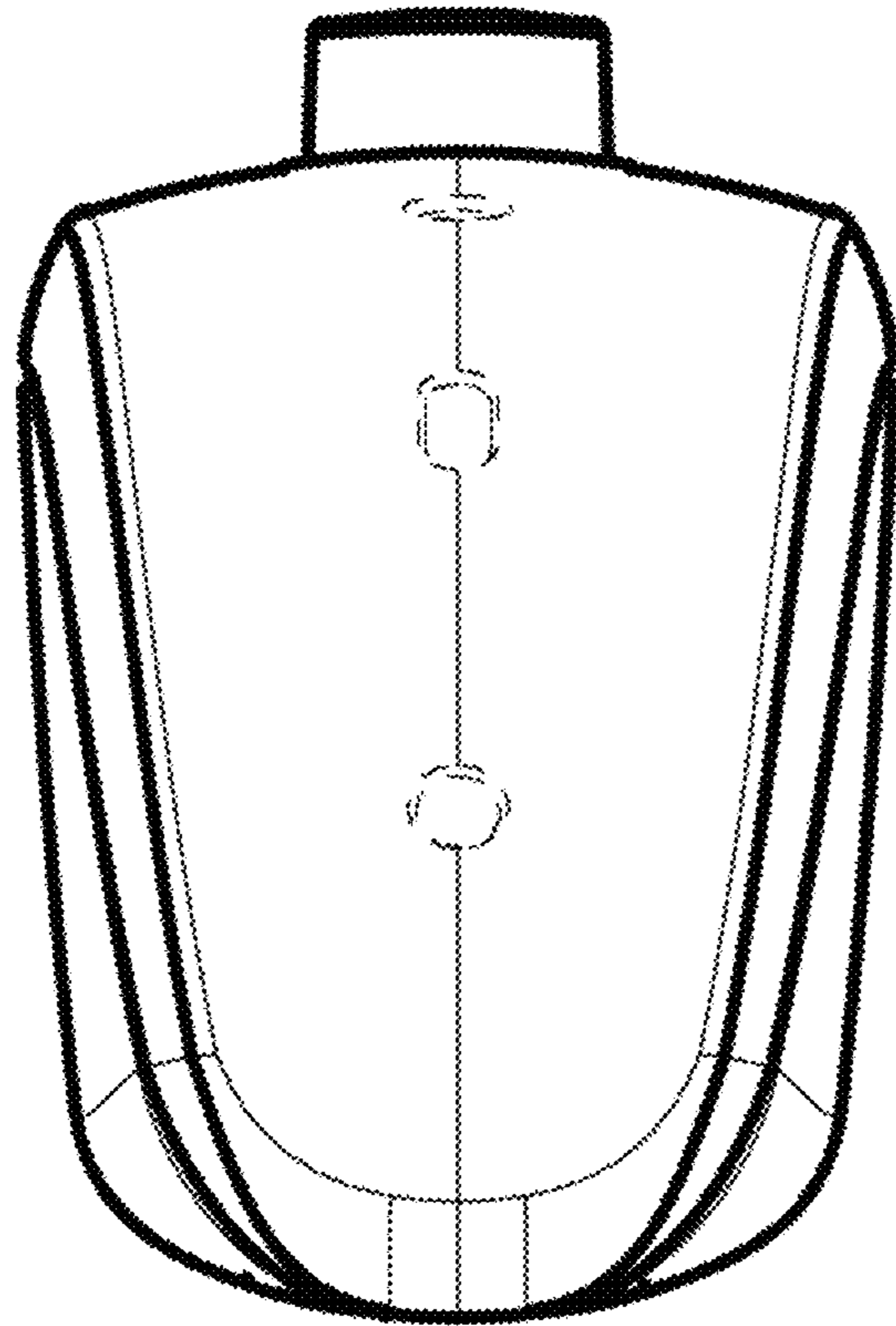

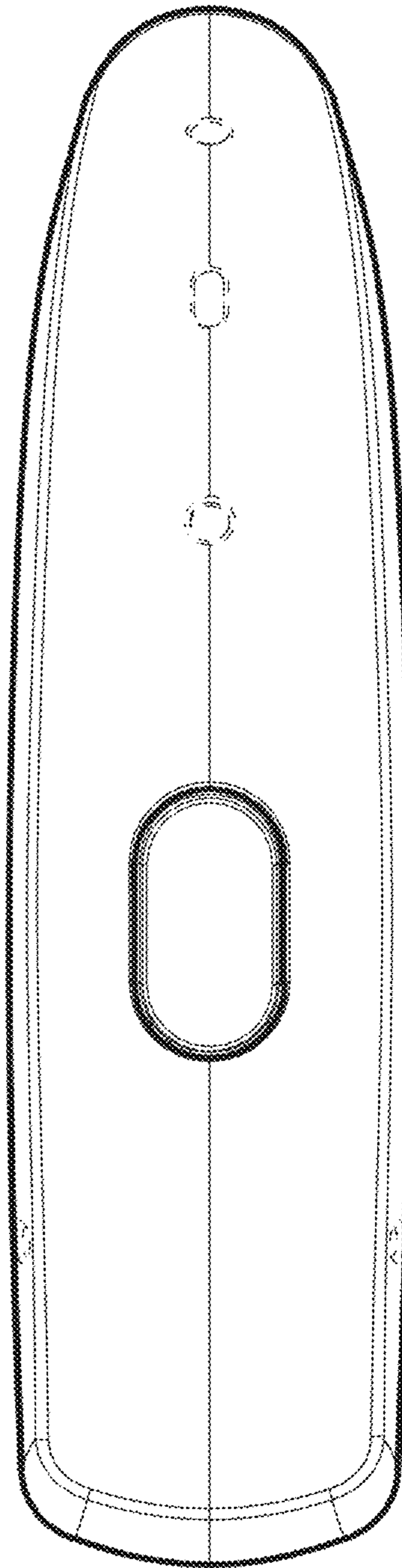

FIG. 5.6

5.7

