



US00D961043S

(12) **United States Design Patent** (10) **Patent No.:** **US D961,043 S**
Wei (45) **Date of Patent:** **** Aug. 16, 2022**

(54) **WATER FILTER CARTRIDGE**
(71) Applicant: **Tianjin Yunda Industry and Trade Co., Ltd., Tianjin (CN)**
(72) Inventor: **Enyu Wei, Tianjin (CN)**
(73) Assignee: **Tianjin Yunda Industry and Trade Co., Ltd., Tianjin (CN)**
(**) Term: **15 Years**

D929,533 S * 8/2021 Huang D23/209
D930,110 S * 9/2021 Lu D23/209
D932,590 S * 10/2021 Du D23/209
D946,703 S * 3/2022 McCollough D23/209
D948,661 S * 4/2022 Zou D23/209
(Continued)

(21) Appl. No.: **29/715,708**
(22) Filed: **Dec. 4, 2019**

FOREIGN PATENT DOCUMENTS

CN 304849650 * 10/2018
KR 30096219610001 * 7/2018

(30) **Foreign Application Priority Data**
Sep. 4, 2019 (CN) 201930486077.8
(51) **LOC (13) Cl.** **23-01**
(52) **U.S. Cl.**
USPC **D23/209**
(58) **Field of Classification Search**
USPC D23/209, 238, 275, 365
CPC B21K 1/24; E03C 1/021
See application file for complete search history.

OTHER PUBLICATIONS

Aquasana filter 2016 found on Jan. 19, 2021 at <https://www.aquasana.com/replacement-drinking-water-filters/reverse-osmosis-remineralizer> (Year: 2016).*
(Continued)

Primary Examiner — Karen S Acker
Assistant Examiner — Jonathan E Fiencke
(74) *Attorney, Agent, or Firm* — Mei & Mark LLP

(56) **References Cited**

U.S. PATENT DOCUMENTS

D321,394 S * 11/1991 Petrucci D23/209
6,533,931 B1 * 3/2003 Reid B01D 35/31
210/232
D599,880 S * 9/2009 Rampen D23/209
D751,170 S * 3/2016 Ruprecht D23/209
D835,752 S * 12/2018 Spiegel D23/209
D865,119 S * 10/2019 An D23/209
D894,332 S * 8/2020 Huaping D23/209
D894,333 S * 8/2020 Huaping D23/209
D917,661 S * 4/2021 Wei D23/209
D917,662 S * 4/2021 Lu D23/209
D921,834 S * 6/2021 Miles D23/209
D924,354 S * 7/2021 Huang D23/209
D925,695 S * 7/2021 Huang D23/209

(57) **CLAIM**

The ornamental design for a water filter cartridge, as shown and described.

DESCRIPTION

FIG. 1 is a perspective view of a water filter cartridge according to the present invention;
FIG. 2 is a front view thereof;
FIG. 3 is a rear view thereof;
FIG. 4 is a left view thereof;
FIG. 5 is a right view thereof;
FIG. 6 is a top view thereof; and,
FIG. 7 is a bottom view thereof.
The broken lines depict portions of the water filter cartridge that form no part of the claimed design. The dot dash dot broken line in FIG. 7 depicts the boundaries of the claim and forms no part thereof.

1 Claim, 4 Drawing Sheets

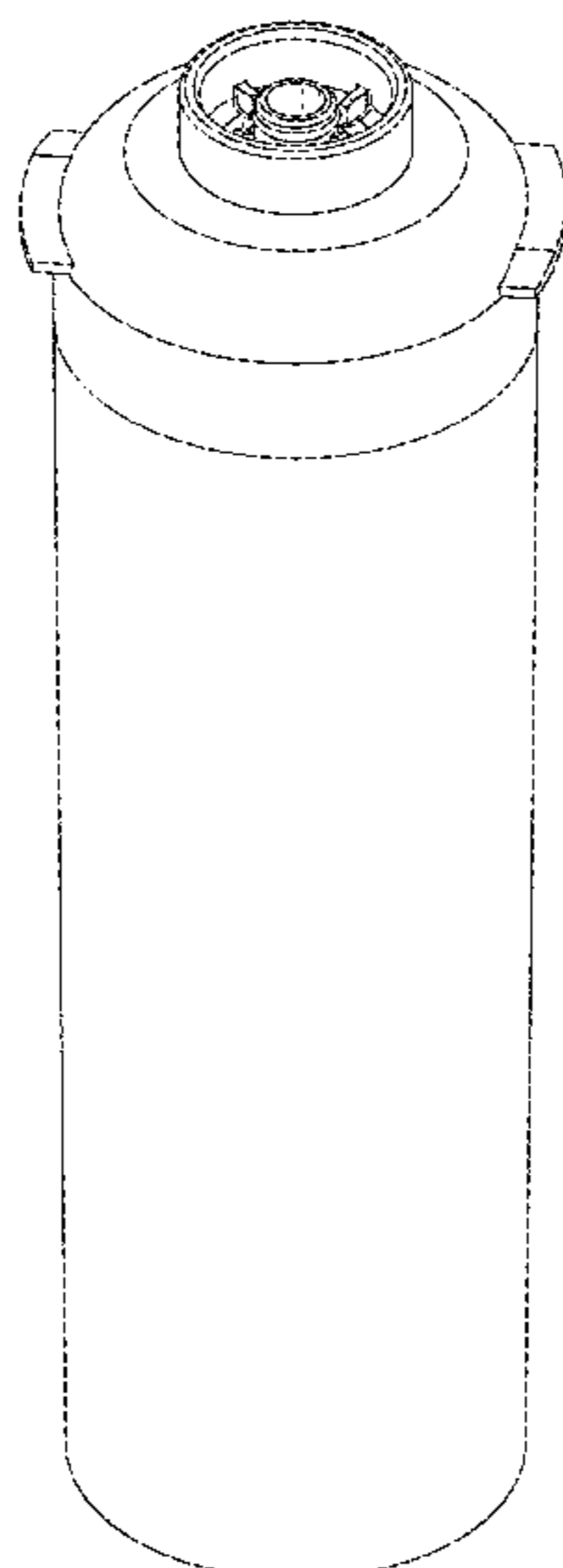

(56)

References Cited

U.S. PATENT DOCUMENTS

D951,393 S * 5/2022 Wei D23/209
2004/0020837 A1* 2/2004 Reid B01D 35/31
210/232
2004/0129627 A1* 7/2004 McGibbon C02F 9/005
210/433.1
2014/0175000 A1* 6/2014 Reid B01D 27/08
210/236
2017/0361276 A1* 12/2017 Muir C02F 1/001
2020/0114285 A1* 4/2020 Courtney B01D 27/08

OTHER PUBLICATIONS

Berkey filter2014 found on Jan. 18, 2021 at <https://www.amazon.com/Black-Berkey-Replacement-Filters-Fluoride/dp/B002R3U0KI/> (Year: 2014).*

* cited by examiner

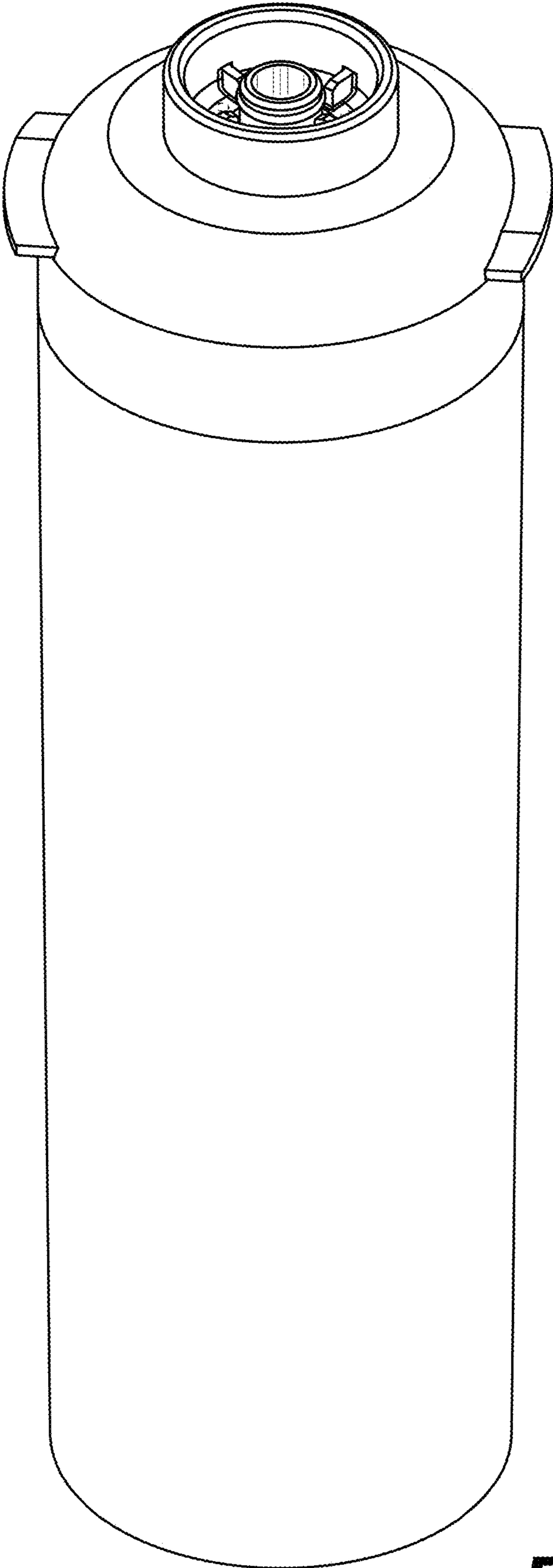

FIG. 1

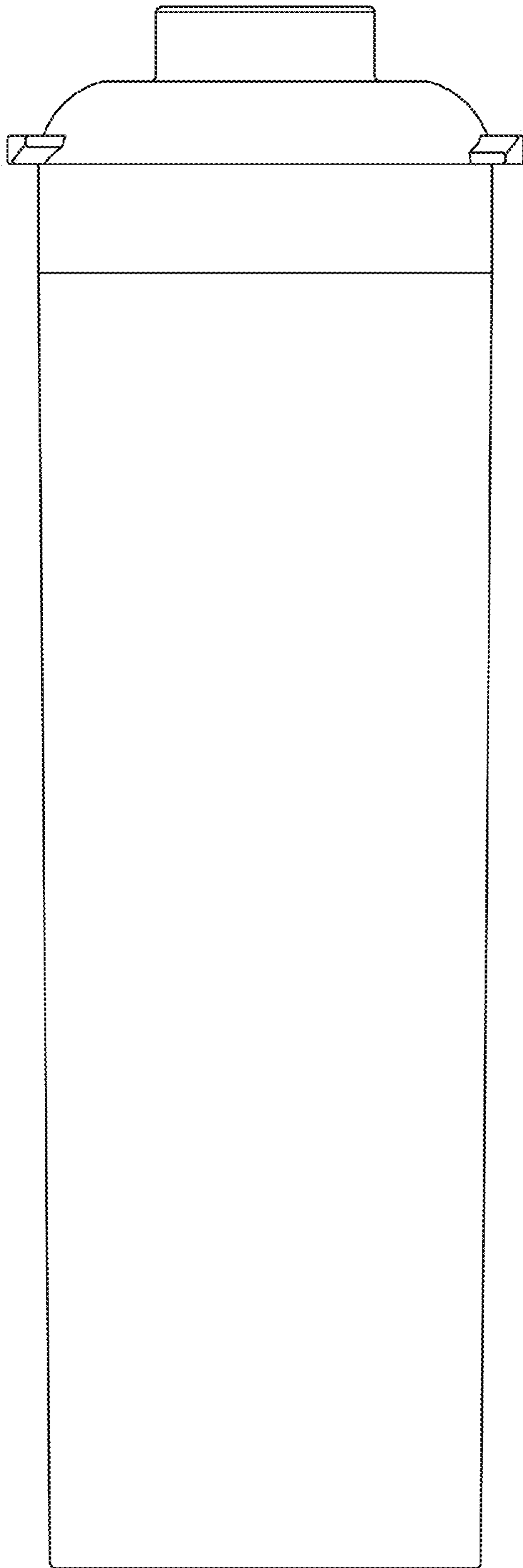

FIG. 2

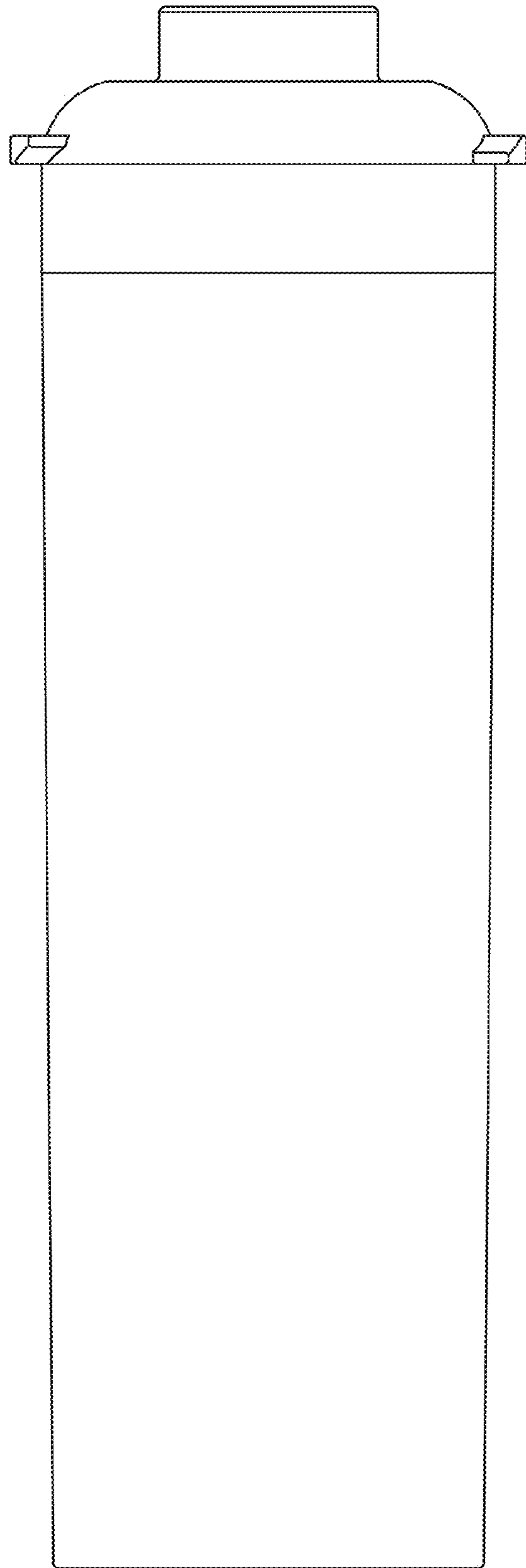

FIG. 3

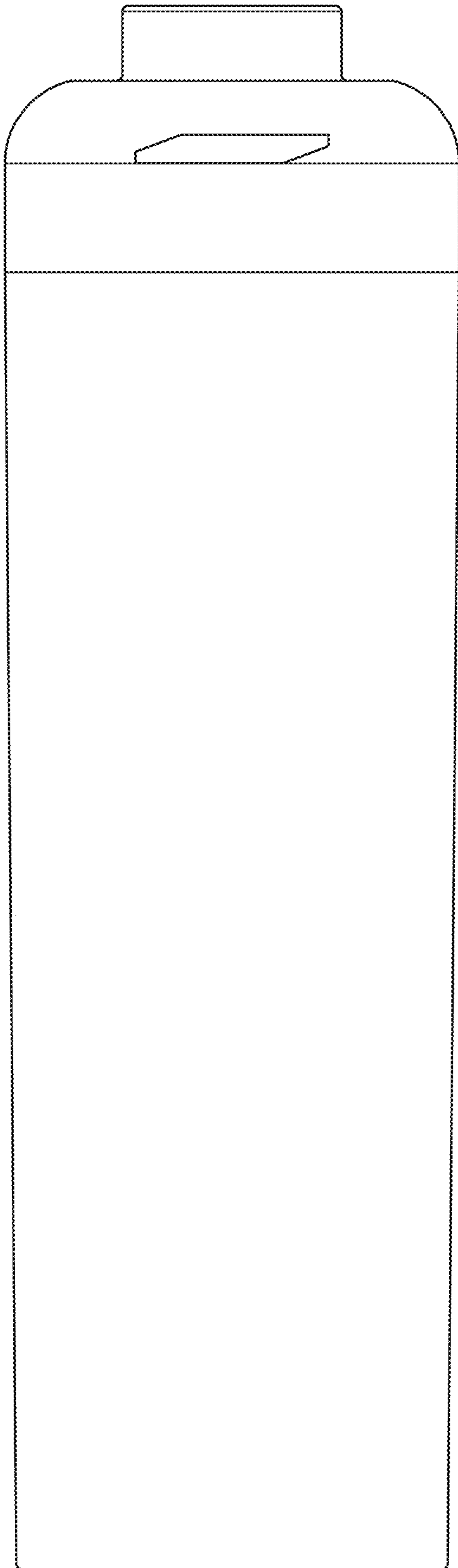

FIG. 4

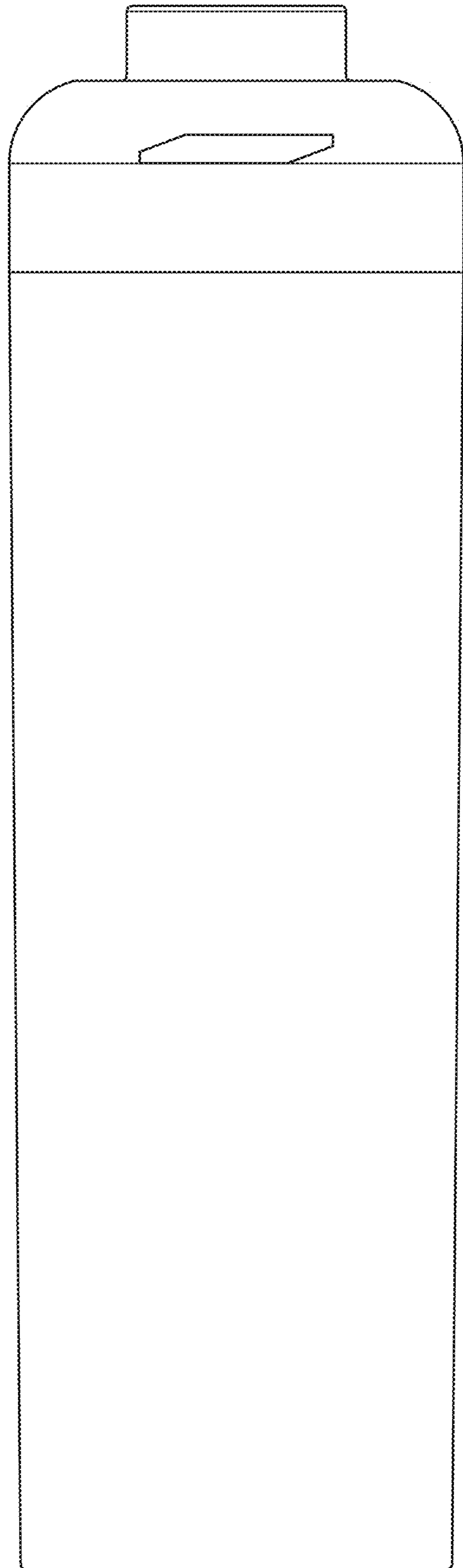

FIG. 5

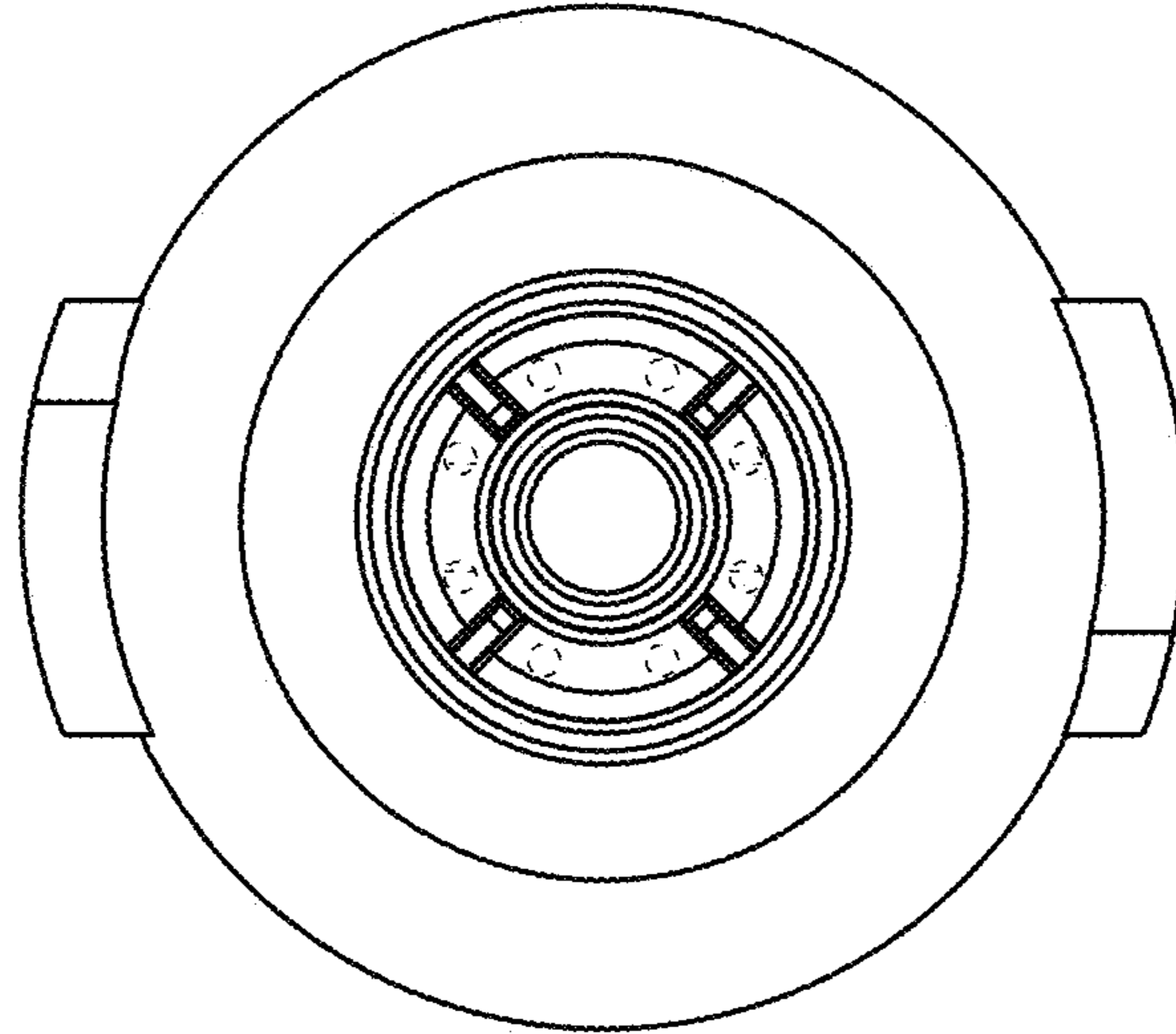

FIG. 6

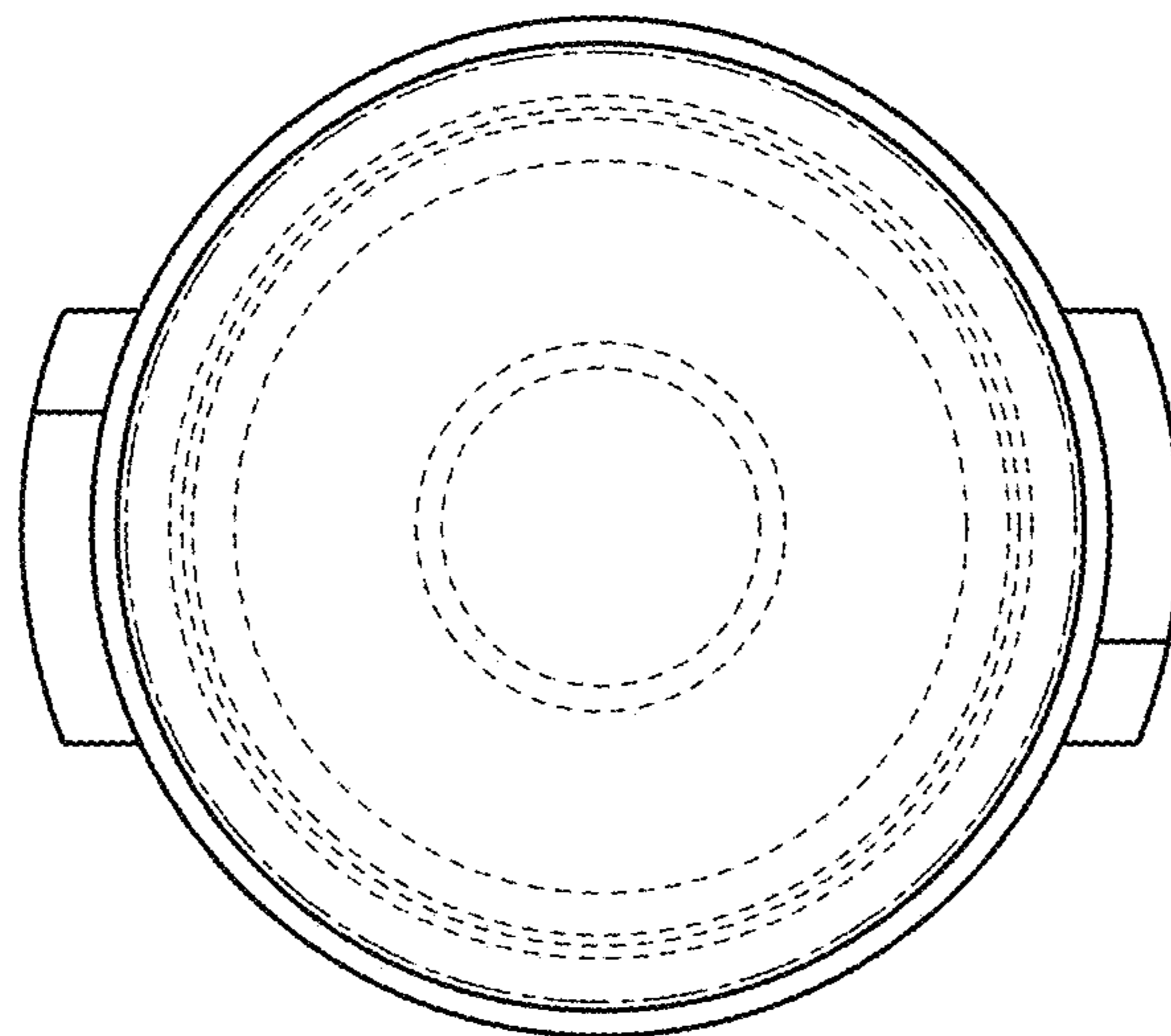

FIG. 7