



US00D961016S

(12) **United States Design Patent**
Flick

(10) **Patent No.:** **US D961,016 S**

(45) **Date of Patent:** **** Aug. 16, 2022**

(54) **FRAME MEMBER OF A STATIONARY BIKE**

(71) Applicant: **NAUTILUS, INC.**, Vancouver, WA
(US)

(72) Inventor: **Edward L. Flick**, Brush Prairie, WA
(US)

(73) Assignee: **Nautilus, Inc.**, Vancouver, WA (US)

(**) Term: **15 Years**

(21) Appl. No.: **29/737,314**

(22) Filed: **Jun. 8, 2020**

(51) **LOC (13) Cl.** **21-02**

(52) **U.S. Cl.**
USPC **D21/667**

(58) **Field of Classification Search**
USPC D21/663, 667, 664, 697; D12/111, 114,
D12/117, 432, 538
See application file for complete search history.

(56) **References Cited**

U.S. PATENT DOCUMENTS

D340,432 S *	10/1993	Osborne	74/551.8
D375,282 S *	11/1996	Lee	D12/117
D377,634 S *	1/1997	DeLeo	D12/114
D379,163 S *	5/1997	Lai	D12/111
D385,228 S *	10/1997	Thompson	D12/111
D590,750 S *	4/2009	Hays	D12/111
D717,700 S *	11/2014	Dasbach	D12/111
D778,147 S *	2/2017	Huang	D8/382

D836,733 S *	12/2018	Curbbun	D21/667
2014/0038781 A1 *	2/2014	Foley	A63F 13/798 482/9
2014/0221168 A1 *	8/2014	Chen	A63B 22/06 482/64
2017/0216662 A1 *	8/2017	Tung	A63B 23/0476
2021/0046373 A1 *	2/2021	Smith	A63B 71/0622

* cited by examiner

Primary Examiner — Khawaja Anwar

Assistant Examiner — Julice Seung Eun Oum

(74) *Attorney, Agent, or Firm* — Dorsey & Whitney LLP

(57) **CLAIM**

The ornamental design for a frame member of a stationary bike, as shown and described.

DESCRIPTION

FIG. 1 shows a front isometric view of a frame member of a stationary bike in accordance with the present design. FIG. 2 shows a rear isometric view thereof. FIG. 3 shows an enlarged front isometric view thereof. FIG. 4 shows an enlarged rear isometric view thereof. FIG. 5 shows a left side view thereof. FIG. 6 shows a right side view thereof. FIG. 7 shows a front view thereof. FIG. 8 shows a rear view thereof. FIG. 9 shows a top view thereof; and, FIG. 10 shows a bottom view thereof. The broken lines represent environment that forms no part of the claimed design.

1 Claim, 8 Drawing Sheets

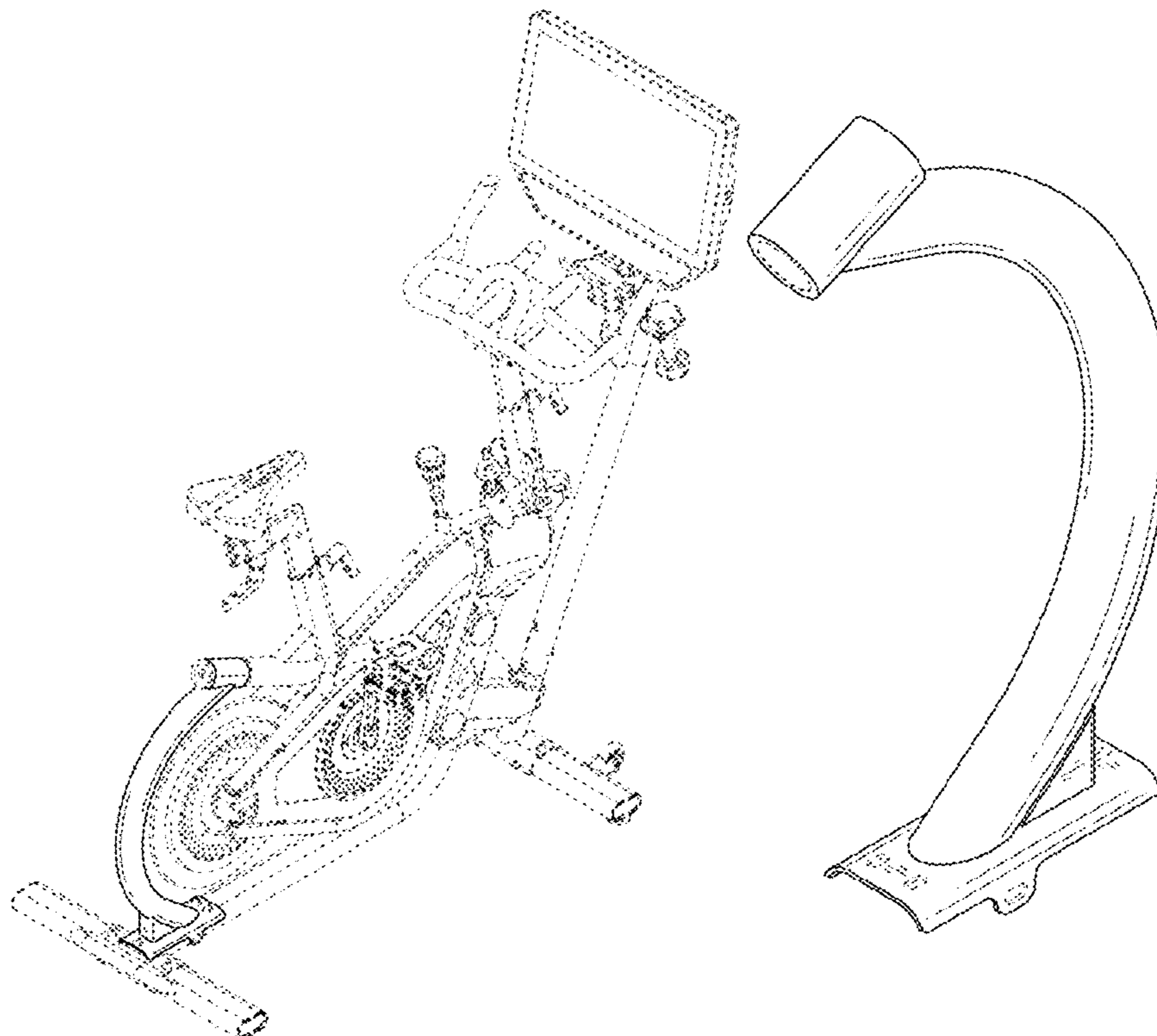

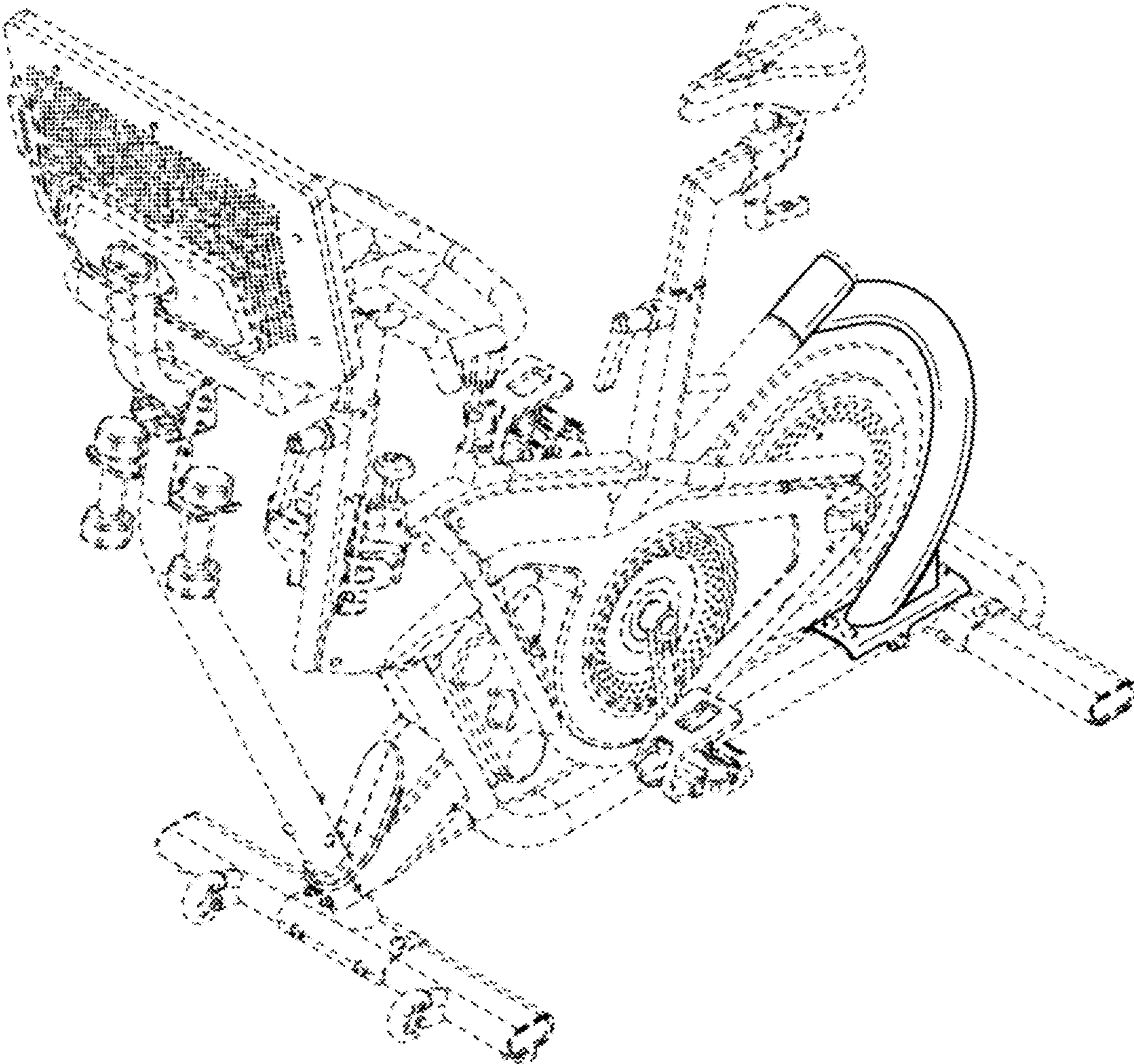

FIG. 1

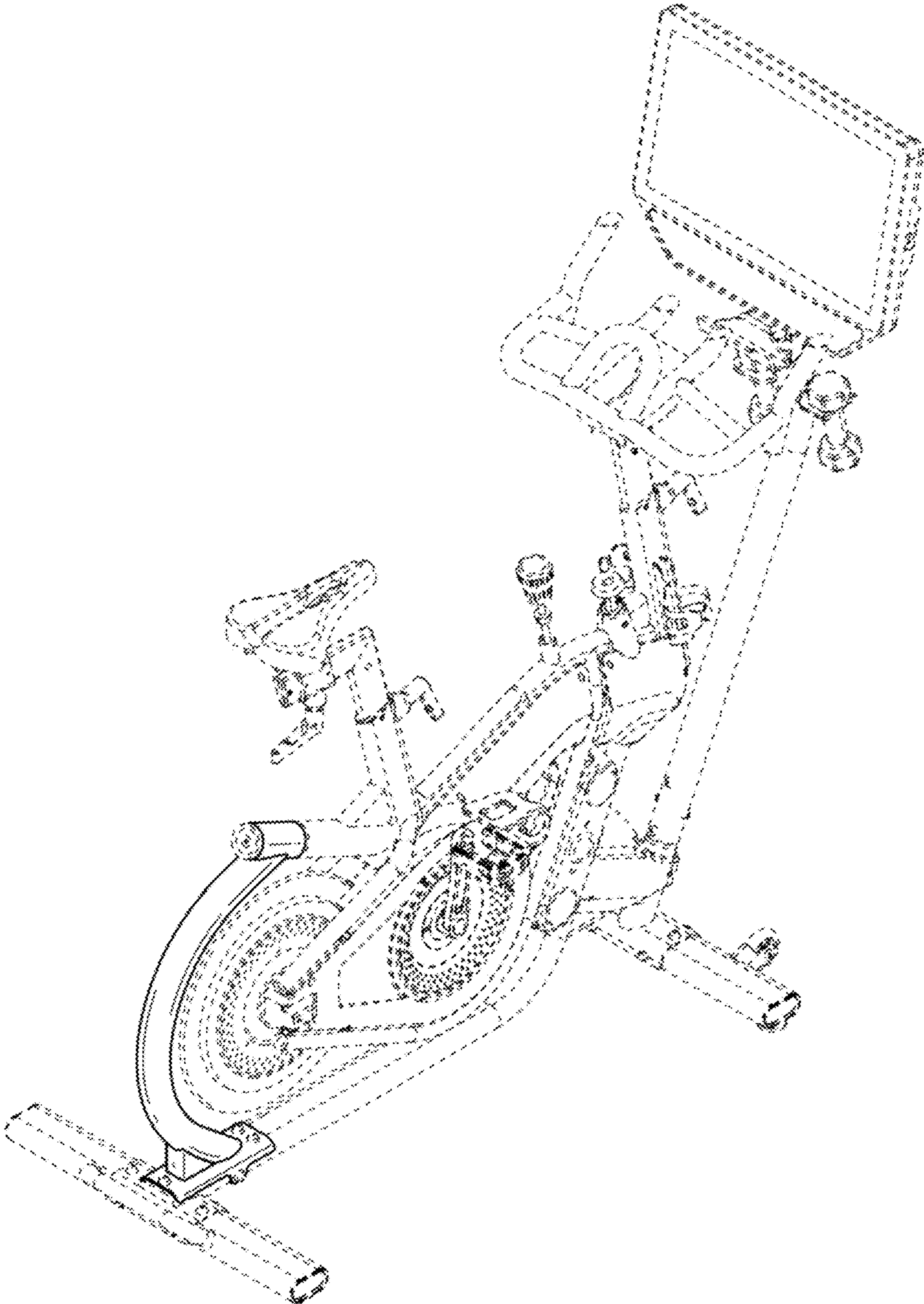

FIG. 2

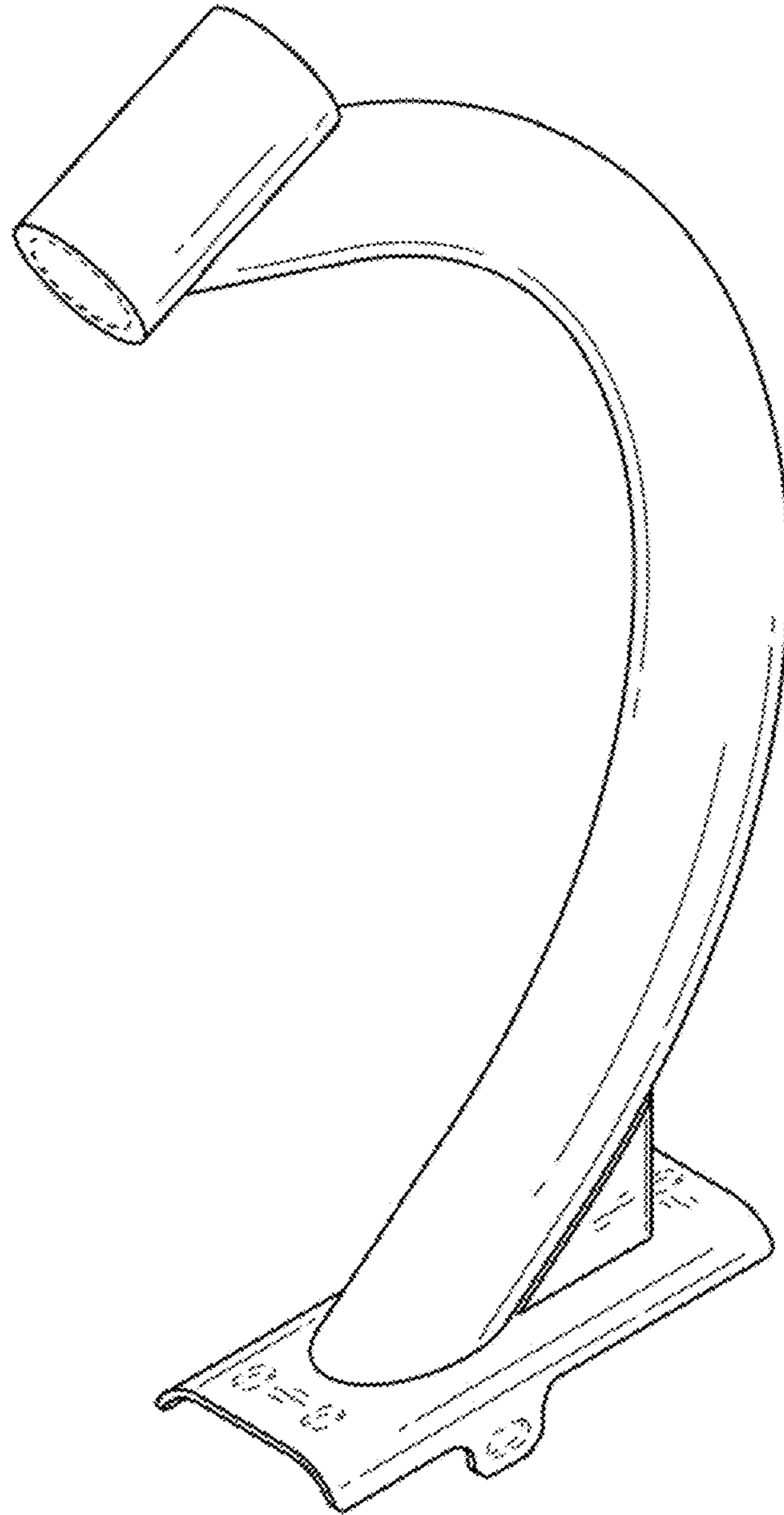

FIG. 3

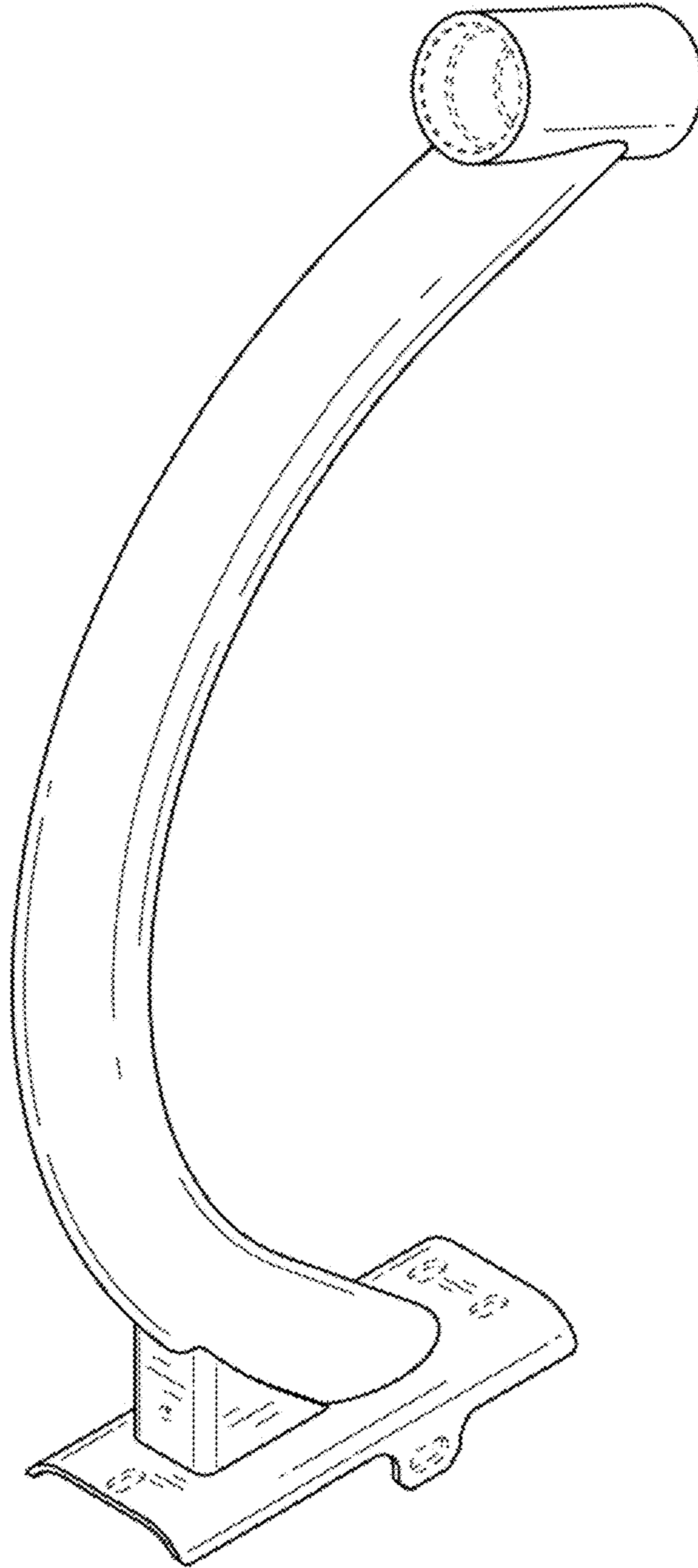

FIG. 4

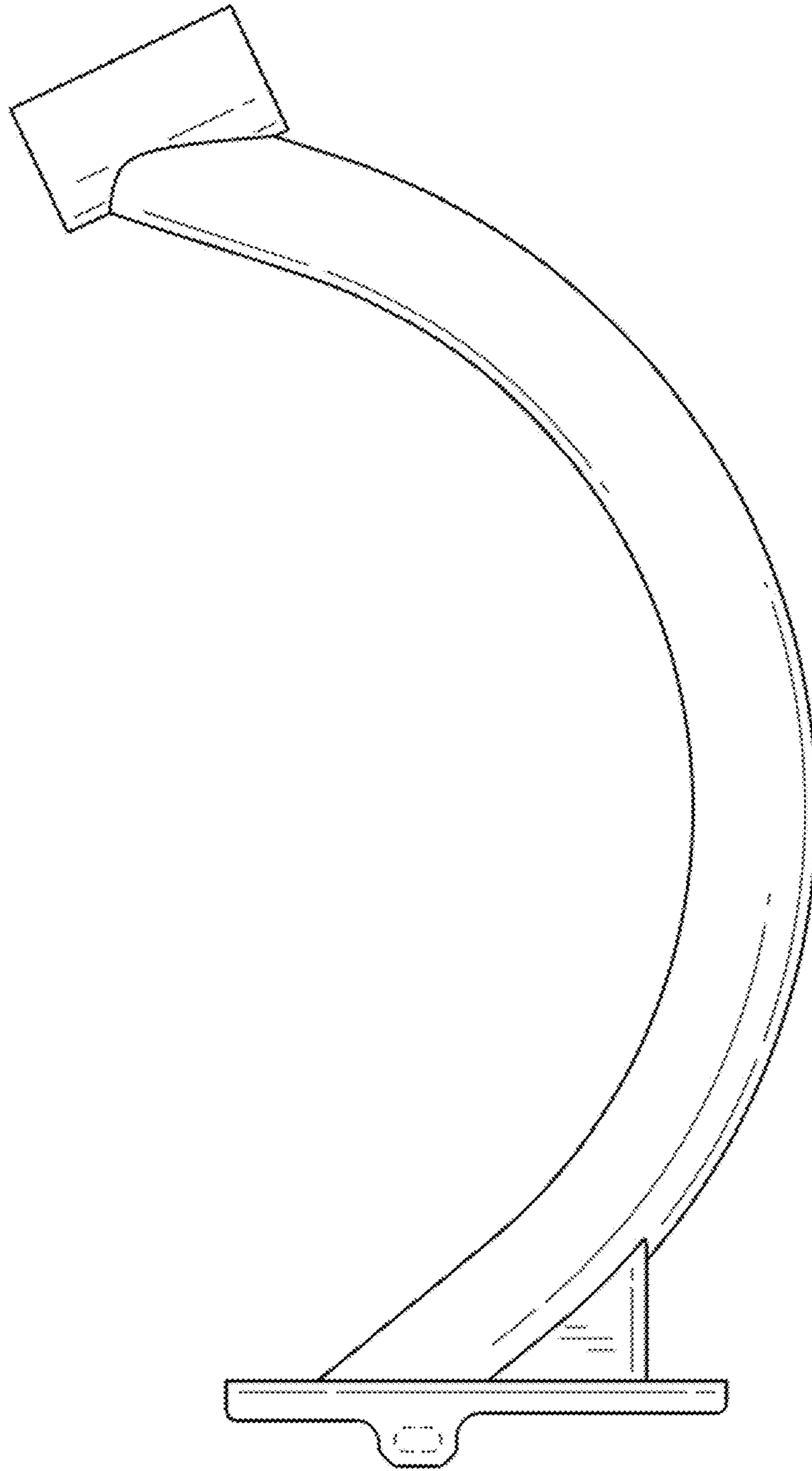

FIG. 5

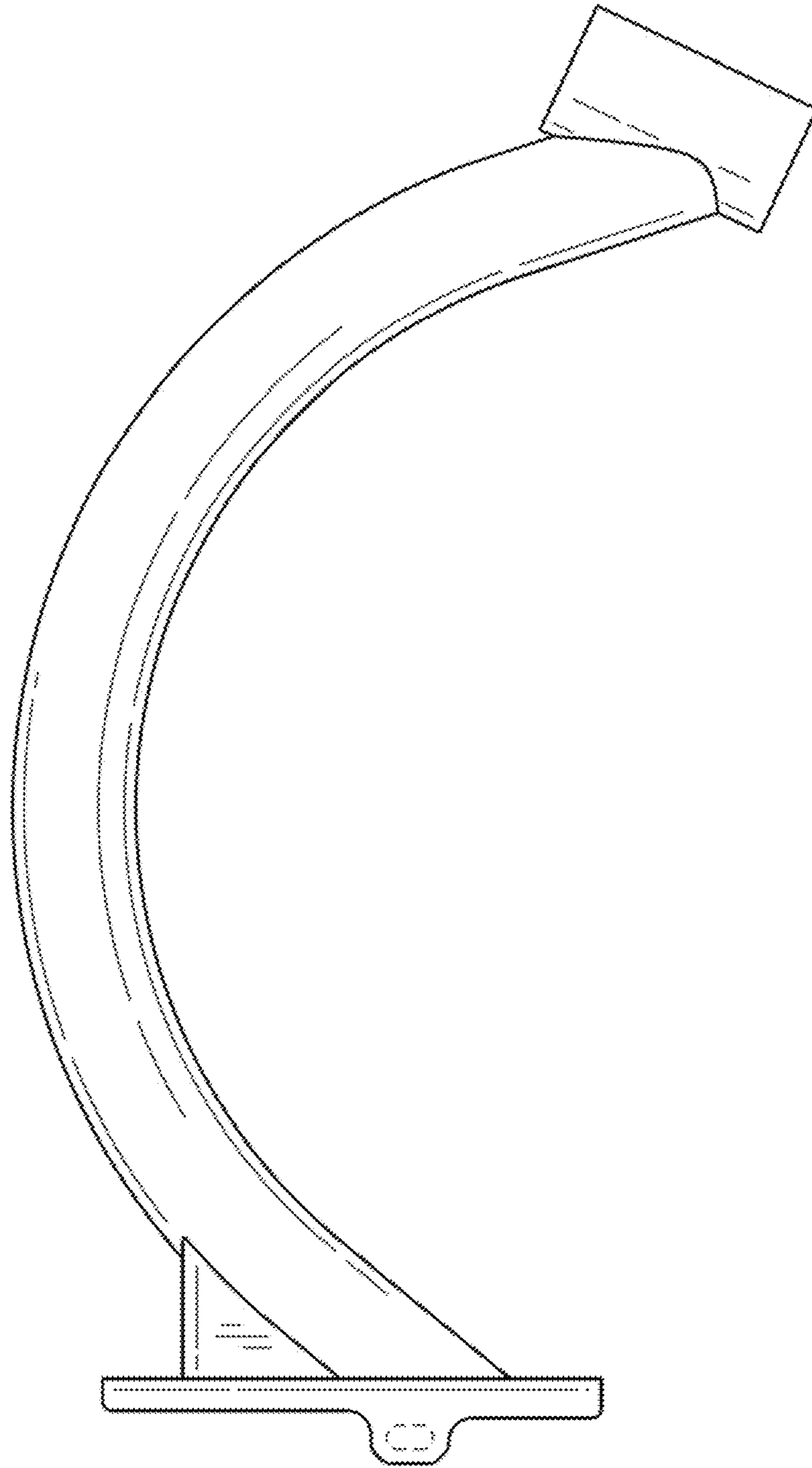

FIG. 6

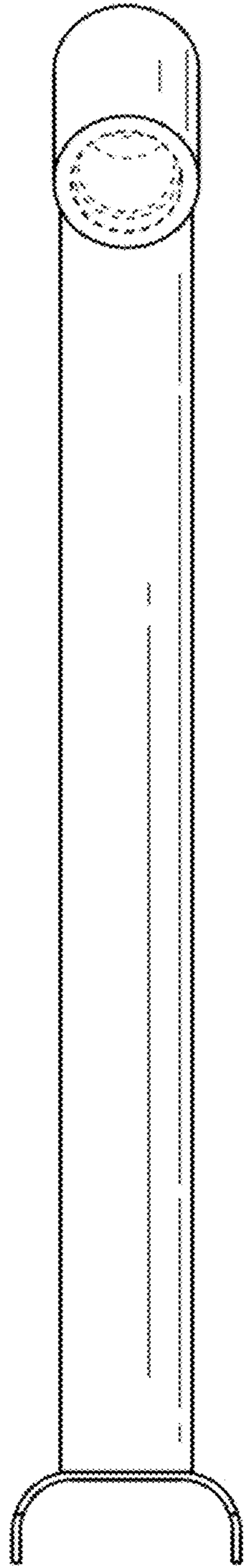

FIG. 7

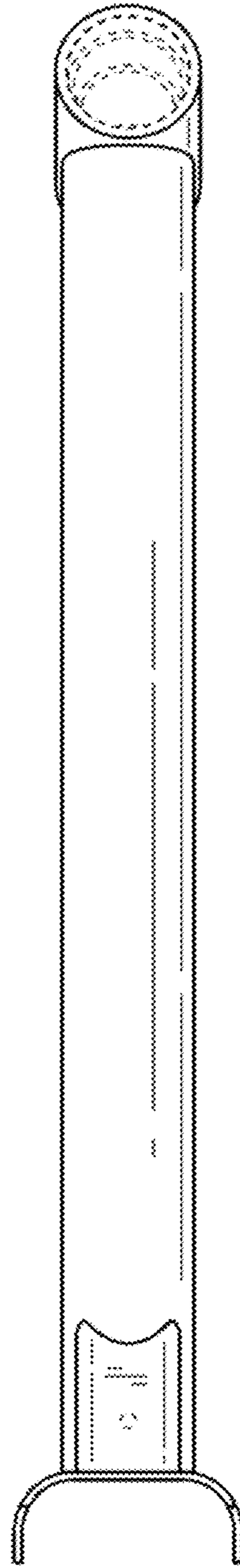

FIG. 8

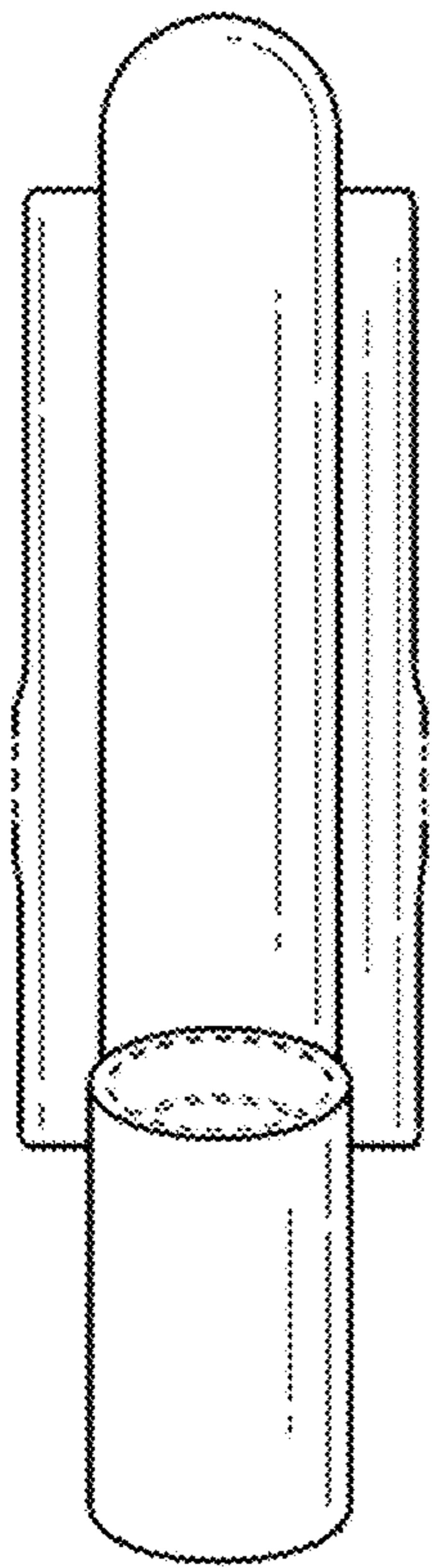

FIG. 9

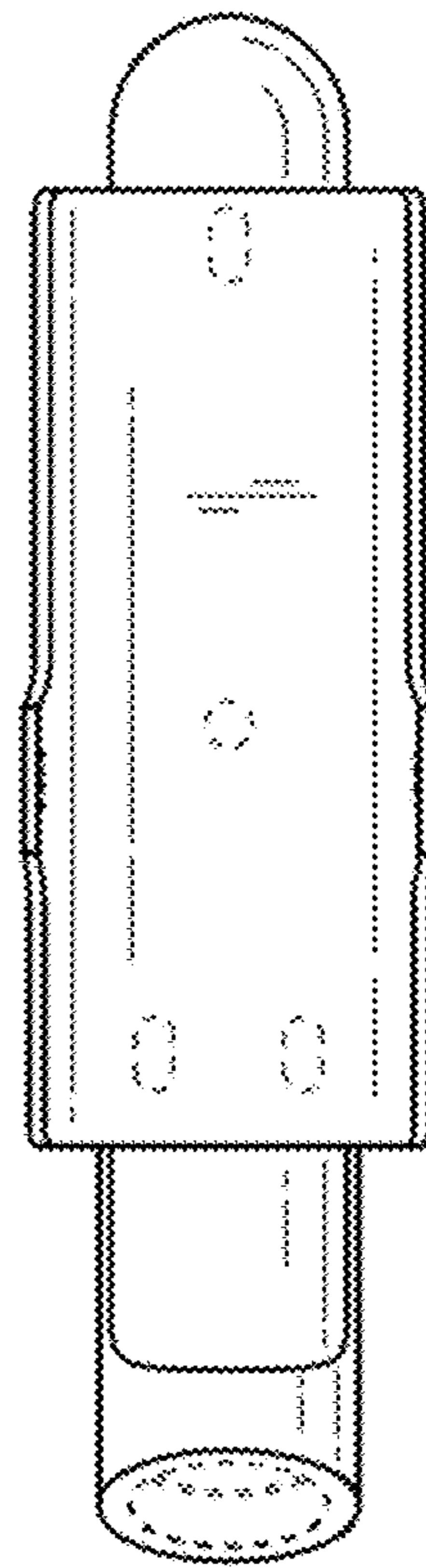

FIG. 10