



US00D960779S

(12) **United States Design Patent**
De Leon

(10) **Patent No.:** **US D960,779 S**

(45) **Date of Patent:** **** Aug. 16, 2022**

(54) **VEHICLE FRONT LOWER BUMPER FASCIA**

(71) Applicant: **GM GLOBAL TECHNOLOGY OPERATIONS LLC**, Detroit, MI (US)

(72) Inventor: **Reymin De Leon**, Birmingham, MI (US)

(73) Assignee: **GM Global Technology Operations LLC**, Detroit, MI (US)

(**) Term: **15 Years**

(21) Appl. No.: **29/757,333**

(22) Filed: **Nov. 5, 2020**

(51) **LOC (13) Cl.** **12-16**

(52) **U.S. Cl.**
USPC **D12/169**

(58) **Field of Classification Search**
USPC D12/169, 163, 196, 86, 90-92;
296/180.1, 180.2; 293/102, 113, 115,
293/117, 120
CPC B60R 2019/25; B62D 25/084
See application file for complete search history.

(56) **References Cited**

U.S. PATENT DOCUMENTS

| | | |
|------------|---------|----------------------|
| D570,742 S | 6/2008 | Takagi et al. |
| D592,105 S | 5/2009 | Dean et al. |
| D597,447 S | 8/2009 | Folden |
| D600,595 S | 9/2009 | Nakamura et al. |
| D601,925 S | 10/2009 | O'Donnell |
| D603,755 S | 11/2009 | Peters |
| D604,203 S | 11/2009 | O'Donnell |
| D605,082 S | 12/2009 | Munson |
| D605,083 S | 12/2009 | Manoogian, II et al. |
| D605,977 S | 12/2009 | Zipfel et al. |
| D605,978 S | 12/2009 | Wolff et al. |
| D608,249 S | 1/2010 | Peters |

| | | |
|--------------|---------|-----------------------|
| D608,690 S | 1/2010 | Folden et al. |
| D608,691 S | 1/2010 | Zak, Jr. et al. |
| D609,608 S | 2/2010 | Boniface et al. |
| D611,387 S | 3/2010 | Thompson et al. |
| D611,879 S | 3/2010 | Kim et al. |
| D612,297 S | 3/2010 | Peters et al. |
| D613,645 S | 4/2010 | Song et al. |
| D615,458 S | 5/2010 | Thompson et al. |
| D618,595 S | 6/2010 | Ware et al. |
| D623,090 S | 9/2010 | Cox et al. |
| D627,262 S | 11/2010 | Ikeda et al. |
| D635,488 S | 4/2011 | Phipps |
| D644,147 S | 8/2011 | Suh et al. |
| D644,567 S | 9/2011 | Kozub |
| D657,718 S | 4/2012 | Zipfel et al. |
| D659,052 S | 5/2012 | Ware et al. |
| D659,053 S | 5/2012 | Ware et al. |
| D664,903 S * | 8/2012 | Platto D12/169 |
| D666,539 S * | 9/2012 | Koizumi D12/169 |
| D668,182 S | 10/2012 | Franco et al. |
| D668,183 S | 10/2012 | Smart |

(Continued)

Primary Examiner — Melody N Brown

(57) **CLAIM**

The ornamental design for a vehicle front lower bumper fascia, as shown and described.

DESCRIPTION

FIG. 1 is a top, front and left side perspective view of a vehicle front lower bumper fascia showing my new design; FIG. 2 is a front elevation view thereof; FIG. 3 is a left side elevation view thereof; FIG. 4 is a right side elevation view thereof; FIG. 5 is a rear elevation view thereof; FIG. 6 is a bottom plan view thereof; and, FIG. 7 is a top plan view thereof. The broken lines in the drawings depict portions of the vehicle front lower bumper fascia that form no part of the claimed design.

1 Claim, 7 Drawing Sheets

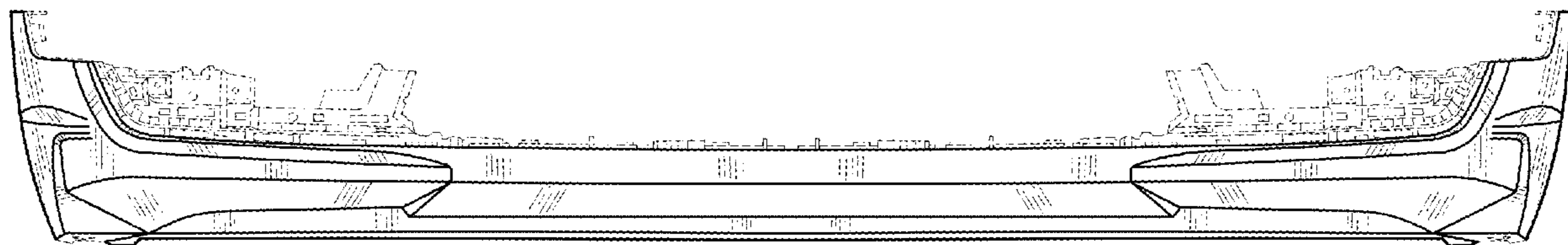

(56)

References Cited

U.S. PATENT DOCUMENTS

| | | | | | |
|------------|---------|------------------|------------|---------|-----------------|
| D678,820 S | 3/2013 | Son et al. | D753,035 S | 4/2016 | Boniface et al. |
| D678,821 S | 3/2013 | Ikeda et al. | D753,559 S | 4/2016 | McMahan et al. |
| D680,909 S | 4/2013 | Munson et al. | D753,560 S | 4/2016 | McMahan et al. |
| D680,910 S | 4/2013 | David | D753,567 S | 4/2016 | Boniface et al. |
| D684,899 S | 6/2013 | Baker | D754,571 S | 4/2016 | Boniface et al. |
| D686,536 S | 7/2013 | McCabe et al. | D754,572 S | 4/2016 | McMahan et al. |
| D692,798 S | 11/2013 | Thurber | D755,088 S | 5/2016 | McMahan et al. |
| D692,799 S | 11/2013 | Smith et al. | D756,869 S | 5/2016 | McMahan et al. |
| D696,157 S | 12/2013 | Loeb | D758,271 S | 6/2016 | McMahan et al. |
| D699,629 S | 2/2014 | Ikeda et al. | D764,975 S | 8/2016 | Aengenheyster |
| D700,871 S | 3/2014 | O'Donnell et al. | D764,976 S | 8/2016 | Aengenheyster |
| D703,103 S | 4/2014 | Lee | D767,449 S | 9/2016 | Pevovar et al. |
| D704,103 S | 5/2014 | Mack et al. | D767,450 S | 9/2016 | Lee et al. |
| D705,132 S | 5/2014 | Ware et al. | D767,451 S | 9/2016 | Kozub et al. |
| D705,699 S | 5/2014 | Ware et al. | D767,454 S | 9/2016 | McMahan et al. |
| D713,298 S | 9/2014 | Dyson | D767,458 S | 9/2016 | Kim |
| D713,764 S | 9/2014 | Ferlazzo et al. | D767,459 S | 9/2016 | Kim |
| D716,696 S | 11/2014 | Thole et al. | D767,460 S | 9/2016 | Kozub et al. |
| D716,706 S | 11/2014 | Thole et al. | D767,461 S | 9/2016 | Kozub et al. |
| D716,709 S | 11/2014 | Thole et al. | D771,528 S | 11/2016 | Smith et al. |
| D717,696 S | 11/2014 | Thole et al. | D771,529 S | 11/2016 | Thole et al. |
| D718,189 S | 11/2014 | Krieg et al. | D771,532 S | 11/2016 | Kapitonov |
| D718,683 S | 12/2014 | Thole et al. | D771,533 S | 11/2016 | Kapitonov |
| D722,282 S | 2/2015 | Loeb | D772,766 S | 11/2016 | Kozub et al. |
| D722,533 S | 2/2015 | Thole et al. | D772,767 S | 11/2016 | Kim |
| D722,534 S | 2/2015 | Munson et al. | D773,084 S | 11/2016 | Kapitonov |
| D724,510 S | 3/2015 | McMahan et al. | D773,086 S | 11/2016 | McCabe et al. |
| D725,001 S | 3/2015 | McMahan et al. | D774,226 S | 12/2016 | McCabe et al. |
| D726,591 S | 4/2015 | Jacob | D775,003 S | 12/2016 | Pevovar et al. |
| D730,776 S | 6/2015 | Smart | D775,007 S | 12/2016 | Thole et al. |
| D730,783 S | 6/2015 | Henriques et al. | D775,010 S | 12/2016 | Kim et al. |
| D732,427 S | 6/2015 | Loeb | D775,049 S | 12/2016 | Scheer et al. |
| D732,429 S | 6/2015 | Loeb | D775,549 S | 1/2017 | Karras |
| D732,430 S | 6/2015 | Loeb | D775,554 S | 1/2017 | Kapitonov |
| D732,431 S | 6/2015 | Loeb | D776,020 S | 1/2017 | Kapitonov |
| D732,432 S | 6/2015 | Aengenheyster | D776,581 S | 1/2017 | Pevovar et al. |
| D732,433 S | 6/2015 | Aengenheyster | D776,583 S | 1/2017 | Scheer et al. |
| D732,435 S | 6/2015 | Mackay | D776,841 S | 1/2017 | Kozub et al. |
| D733,002 S | 6/2015 | Loeb | D776,843 S | 1/2017 | McCabe et al. |
| D735,611 S | 8/2015 | Aengenheyster | D776,846 S | 1/2017 | Willett et al. |
| D735,627 S | 8/2015 | Smith | D777,359 S | 1/2017 | Kozub et al. |
| D736,451 S | 8/2015 | Smith | D777,360 S | 1/2017 | Kozub et al. |
| D739,306 S | 9/2015 | McMahan et al. | D777,361 S | 1/2017 | Kozub et al. |
| D739,317 S | 9/2015 | McMahan et al. | D777,604 S | 1/2017 | McNerney |
| D741,223 S | 10/2015 | Kim et al. | D777,605 S | 1/2017 | Ferlazzo et al. |
| D743,309 S | 11/2015 | Thole et al. | D777,620 S | 1/2017 | Pevovar et al. |
| D743,313 S | 11/2015 | Smith et al. | D777,621 S | 1/2017 | Kim |
| D743,314 S | 11/2015 | Thole et al. | D777,622 S | 1/2017 | Kozub et al. |
| D743,857 S | 11/2015 | McMahan et al. | D777,628 S | 1/2017 | Kozub et al. |
| D744,158 S | 11/2015 | Willett et al. | D777,955 S | 1/2017 | Willett et al. |
| D745,086 S | 12/2015 | Finos et al. | D778,212 S | 2/2017 | Kozub et al. |
| D745,719 S | 12/2015 | Boniface et al. | D778,215 S | 2/2017 | Kozub et al. |
| D745,725 S | 12/2015 | McMahan et al. | D780,064 S | 2/2017 | Smith et al. |
| D745,726 S | 12/2015 | McMahan et al. | D780,067 S | 2/2017 | Zipfel et al. |
| D745,837 S | 12/2015 | Smith et al. | D780,068 S | 2/2017 | Whitla et al. |
| D746,726 S | 1/2016 | Smith et al. | D780,077 S | 2/2017 | Kim et al. |
| D746,727 S | 1/2016 | Smith et al. | D780,081 S | 2/2017 | Lee |
| D746,728 S | 1/2016 | Smith et al. | D780,084 S | 2/2017 | Scheer et al. |
| D746,729 S | 1/2016 | Boniface et al. | D780,631 S | 3/2017 | Kozub et al. |
| D746,730 S | 1/2016 | Kim et al. | D780,644 S | 3/2017 | Kim et al. |
| D747,514 S | 1/2016 | McMahan et al. | D781,184 S | 3/2017 | Thole et al. |
| D747,515 S | 1/2016 | McMahan et al. | D781,192 S | 3/2017 | Kozub et al. |
| D747,819 S | 1/2016 | Thole et al. | D782,379 S | 3/2017 | Wassell |
| D749,021 S | 2/2016 | Boniface et al. | D783,482 S | 4/2017 | Smith et al. |
| D749,026 S | 2/2016 | Smith et al. | D784,213 S | 4/2017 | Karras |
| D749,027 S | 2/2016 | McMahan et al. | D784,223 S | 4/2017 | Lee |
| D749,246 S | 2/2016 | Thole et al. | D784,226 S | 4/2017 | Cheng |
| D749,249 S | 2/2016 | Thole et al. | D784,579 S | 4/2017 | Cheng et al. |
| D749,250 S | 2/2016 | Thole et al. | D784,877 S | 4/2017 | Lee |
| D749,985 S | 2/2016 | Kozub et al. | D784,886 S | 4/2017 | Smith et al. |
| D749,997 S | 2/2016 | McMahan et al. | D785,521 S | 5/2017 | Smith et al. |
| D750,001 S | 2/2016 | Thole et al. | D786,149 S | 5/2017 | Pevovar et al. |
| D753,032 S | 4/2016 | Smith et al. | D786,743 S | 5/2017 | Smith et al. |
| D753,033 S | 4/2016 | Thole et al. | D786,750 S | 5/2017 | Lee |
| D753,034 S | 4/2016 | Thole et al. | D787,446 S | 5/2017 | Cockerill |
| | | | D787,984 S | 5/2017 | Fang |
| | | | D787,988 S | 5/2017 | Lee |
| | | | D787,989 S | 5/2017 | Kozub et al. |
| | | | D787,990 S | 5/2017 | Kozub et al. |

(56)

References Cited

U.S. PATENT DOCUMENTS

| | | | | | |
|------------|---------|----------------|------------|---------|-----------------|
| D787,992 S | 5/2017 | Lee | D804,371 S | 12/2017 | Whitla et al. |
| D787,993 S | 5/2017 | McCabe et al. | D804,372 S | 12/2017 | Kozub |
| D788,001 S | 5/2017 | Lee | D804,378 S | 12/2017 | Perkins |
| D788,641 S | 6/2017 | Arnold | D804,379 S | 12/2017 | McMahan |
| D788,644 S | 6/2017 | Mueller | D805,006 S | 12/2017 | Nakamura |
| D788,645 S | 6/2017 | Mueller | D805,013 S | 12/2017 | Whitla |
| D789,250 S | 6/2017 | Arnold | D805,014 S | 12/2017 | Zipfel |
| D789,260 S | 6/2017 | Smith | D805,441 S | 12/2017 | Karras |
| D789,575 S | 6/2017 | Willett | D805,964 S | 12/2017 | Whitla |
| D789,841 S | 6/2017 | Lee | D805,965 S | 12/2017 | Davis |
| D789,849 S | 6/2017 | Lee | D805,966 S | 12/2017 | Perkins |
| D791,018 S | 7/2017 | Mylenek | D805,985 S | 12/2017 | Nakamura |
| D791,644 S | 7/2017 | Fang | D807,232 S | 1/2018 | Bailie |
| D792,290 S | 7/2017 | Smith et al. | D807,239 S | 1/2018 | Perkins |
| D792,293 S | 7/2017 | McCabe et al. | D807,240 S | 1/2018 | Perkins |
| D792,294 S | 7/2017 | McCabe et al. | D807,241 S | 1/2018 | Perkins |
| D792,295 S | 7/2017 | McCabe et al. | D809,442 S | 2/2018 | Zipfel et al. |
| D792,815 S | 7/2017 | Kozub | D811,269 S | 2/2018 | Thompson et al. |
| D792,816 S | 7/2017 | Kozub | D811,942 S | 3/2018 | Jacob |
| D793,290 S | 8/2017 | Kozub | D811,957 S | 3/2018 | Whitla et al. |
| D793,292 S | 8/2017 | Lee | D811,958 S | 3/2018 | Zipfel et al. |
| D793,293 S | 8/2017 | Lee et al. | D811,959 S | 3/2018 | Perkins |
| D793,294 S | 8/2017 | Lee | D811,960 S | 3/2018 | Nakamura |
| D793,295 S | 8/2017 | McCabe et al. | D811,961 S | 3/2018 | Sullivan |
| D793,296 S | 8/2017 | Smith et al. | D811,962 S | 3/2018 | Sullivan |
| D793,297 S | 8/2017 | Smith et al. | D811,963 S | 3/2018 | Sullivan |
| D793,299 S | 8/2017 | Kreig et al. | D811,964 S | 3/2018 | Perkins |
| D793,300 S | 8/2017 | Kreig et al. | D811,965 S | 3/2018 | Moffett et al. |
| D793,301 S | 8/2017 | Kozub | D812,525 S | 3/2018 | Lee |
| D793,302 S | 8/2017 | Kozub | D812,526 S | 3/2018 | Zipfel et al. |
| D793,311 S | 8/2017 | Whitla et al. | D812,527 S | 3/2018 | Perkins |
| D793,590 S | 8/2017 | Kozub et al. | D812,528 S | 3/2018 | Nakamura |
| D793,591 S | 8/2017 | Kozub et al. | D813,098 S | 3/2018 | Thompson et al. |
| D793,917 S | 8/2017 | Kozub | D813,109 S | 3/2018 | Zipfel et al. |
| D793,918 S | 8/2017 | Kozub | D813,110 S | 3/2018 | Whitla et al. |
| D794,229 S | 8/2017 | Barry | D813,111 S | 3/2018 | Sullivan |
| D794,230 S | 8/2017 | Kozub | D813,116 S | 3/2018 | Park |
| D795,747 S | 8/2017 | Bailie | D813,117 S | 3/2018 | Sullivan |
| D795,757 S | 8/2017 | Pevovar et al. | D813,121 S | 3/2018 | Swanseger |
| D795,758 S | 8/2017 | Karras | D813,730 S | 3/2018 | Zipfel et al. |
| D795,759 S | 8/2017 | Kozub et al. | D813,731 S | 3/2018 | McMahan |
| D795,760 S | 8/2017 | Kozub et al. | D813,732 S | 3/2018 | Whitla et al. |
| D795,762 S | 8/2017 | Lee | D813,733 S | 3/2018 | Lee |
| D795,763 S | 8/2017 | Kozub | D813,734 S | 3/2018 | Nakamura |
| D796,088 S | 8/2017 | McCabe et al. | D813,740 S | 3/2018 | Park |
| D796,093 S | 8/2017 | Mainville | D813,741 S | 3/2018 | Perkins |
| D796,390 S | 9/2017 | Pevovar et al. | D813,742 S | 3/2018 | McMahan et al. |
| D797,537 S | 9/2017 | Cooper et al. | D813,743 S | 3/2018 | Lee |
| D797,603 S | 9/2017 | Noone et al. | D813,744 S | 3/2018 | Whitla et al. |
| D797,614 S | 9/2017 | Lee | D813,748 S | 3/2018 | Kim |
| D797,616 S | 9/2017 | Lee | D813,753 S | 3/2018 | Loeb |
| D797,624 S | 9/2017 | Nakamura | D813,754 S | 3/2018 | Loeb |
| D797,625 S | 9/2017 | Perkins | D813,755 S | 3/2018 | Loeb |
| D797,631 S | 9/2017 | Pevovar et al. | D813,756 S | 3/2018 | Loeb |
| D797,632 S | 9/2017 | Zipfel et al. | D813,757 S | 3/2018 | Kozub |
| D797,967 S | 9/2017 | Barry | D813,758 S | 3/2018 | Gonzales |
| D797,970 S | 9/2017 | Mainville | D813,759 S | 3/2018 | Perkins |
| D797,971 S | 9/2017 | Mainville | D814,369 S | 4/2018 | Loeb |
| D797,972 S | 9/2017 | Whitla et al. | D814,982 S | 4/2018 | Whitla et al. |
| D798,204 S | 9/2017 | Mainville | D814,983 S | 4/2018 | Whitla et al. |
| D799,384 S | 10/2017 | Kozub et al. | D815,570 S | 4/2018 | McMahan et al. |
| D799,385 S | 10/2017 | Kozub et al. | D815,572 S | 4/2018 | Perkins |
| D799,386 S | 10/2017 | Kozub et al. | D815,573 S | 4/2018 | Whitla et al. |
| D799,728 S | 10/2017 | Whitla et al. | D815,574 S | 4/2018 | Mainville |
| D801,236 S | 10/2017 | Kozub et al. | D815,985 S | 4/2018 | Mueller |
| D801,577 S | 10/2017 | Ruiz | D815,993 S | 4/2018 | Kozub et al. |
| D801,882 S | 11/2017 | Kozub et al. | D815,994 S | 4/2018 | Nakamura |
| D802,205 S | 11/2017 | Ruiz | D816,003 S | 4/2018 | Perkins |
| D802,478 S | 11/2017 | Perkins | D816,558 S | 5/2018 | McMahan et al. |
| D802,491 S | 11/2017 | Mainville | D816,559 S | 5/2018 | McMahan et al. |
| D802,496 S | 11/2017 | Mainville | D816,561 S | 5/2018 | McMahan |
| D802,502 S | 11/2017 | McMahan | D816,562 S | 5/2018 | Whitla et al. |
| D803,727 S | 11/2017 | Noone et al. | D816,563 S | 5/2018 | McMahan et al. |
| D803,731 S | 11/2017 | Zipfel | D816,564 S | 5/2018 | Kim |
| D804,370 S | 12/2017 | Kozub et al. | D816,565 S | 5/2018 | Kim |
| | | | D816,566 S | 5/2018 | Loeb |
| | | | D817,836 S | 5/2018 | McMahan et al. |
| | | | D818,156 S | 5/2018 | Kim et al. |
| | | | D818,157 S | 5/2018 | Zipfel et al. |

(56)

References Cited

U.S. PATENT DOCUMENTS

| | | | | | |
|------------|---------|------------------|------------|--------|-------------------|
| D818,158 S | 5/2018 | Zipfel et al. | D841,527 S | 2/2019 | Kozub et al. |
| D818,159 S | 5/2018 | Zipfel et al. | D841,532 S | 2/2019 | Koo et al. |
| D818,160 S | 5/2018 | Perkins | D841,540 S | 2/2019 | Koo et al. |
| D818,406 S | 5/2018 | McMahan et al. | D841,541 S | 2/2019 | Krieg |
| D818,876 S | 5/2018 | Whitla et al. | D841,542 S | 2/2019 | Koo et al. |
| D818,877 S | 5/2018 | Nakamura et al. | D841,547 S | 2/2019 | Zipfel et al. |
| D818,878 S | 5/2018 | McMahan et al. | D841,843 S | 2/2019 | Park |
| D818,892 S | 5/2018 | Lee | D841,844 S | 2/2019 | Perkins |
| D818,893 S | 5/2018 | Kim | D841,845 S | 2/2019 | Park |
| D818,903 S | 5/2018 | Zipfel et al. | D842,306 S | 2/2019 | Lindo et al. |
| D818,906 S | 5/2018 | McMahan | D842,178 S | 3/2019 | Pinazzo et al. |
| D818,907 S | 5/2018 | Whitla et al. | D843,023 S | 3/2019 | Whitla et al. |
| D818,915 S | 5/2018 | Kozub et al. | D843,024 S | 3/2019 | Hochmuth |
| D818,922 S | 5/2018 | Whitla et al. | D843,025 S | 3/2019 | Smith et al. |
| D819,505 S | 6/2018 | McMahan et al. | D843,275 S | 3/2019 | Koo et al. |
| D819,519 S | 6/2018 | Whitla et al. | D843,280 S | 3/2019 | Thurber et al. |
| D821,617 S | 6/2018 | Perkins | D843,614 S | 3/2019 | Whitla et al. |
| D822,550 S | 7/2018 | Wassell et al. | D843,616 S | 3/2019 | Smith et al. |
| D822,551 S | 7/2018 | McMahan et al. | D843,617 S | 3/2019 | Smith et al. |
| D823,188 S | 7/2018 | Loeb | D843,891 S | 3/2019 | Thompson et al. |
| D823,738 S | 7/2018 | Kim | D843,904 S | 3/2019 | Kim |
| D823,741 S | 7/2018 | Kim | D844,184 S | 3/2019 | Whitla et al. |
| D823,762 S | 7/2018 | Loeb | D844,185 S | 3/2019 | Hochmuth |
| D823,763 S | 7/2018 | Koo et al. | D844,186 S | 3/2019 | Smith et al. |
| D824,811 S | 8/2018 | Mainville | D845,184 S | 4/2019 | Zipfel |
| D824,812 S | 8/2018 | Loeb | D845,186 S | 4/2019 | Koo et al. |
| D824,824 S | 8/2018 | Kim | D845,187 S | 4/2019 | Pinazzo et al. |
| D824,825 S | 8/2018 | Loeb | D845,188 S | 4/2019 | Pinazzo et al. |
| D825,083 S | 8/2018 | Perkins | D845,189 S | 4/2019 | Pinazzo et al. |
| D825,388 S | 8/2018 | Karras et al. | D845,190 S | 4/2019 | Zipfel |
| D825,403 S | 8/2018 | Whitla et al. | D845,196 S | 4/2019 | Kozub |
| D826,114 S | 8/2018 | Smith et al. | D845,518 S | 4/2019 | Kozub |
| D826,435 S | 8/2018 | Kim | D845,519 S | 4/2019 | Zipfel |
| D826,803 S | 8/2018 | Smith et al. | D846,448 S | 4/2019 | Loeb |
| D827,506 S | 9/2018 | McMahan et al. | D846,457 S | 4/2019 | Koo et al. |
| D827,508 S | 9/2018 | Whitla et al. | D846,458 S | 4/2019 | Mack et al. |
| D827,510 S | 9/2018 | Kim | D846,769 S | 4/2019 | Koo et al. |
| D827,527 S | 9/2018 | Loeb | D846,770 S | 4/2019 | Kozub |
| D828,246 S | 9/2018 | Loeb | D846,771 S | 4/2019 | Zipfel |
| D828,261 S | 9/2018 | Moffett et al. | D846,772 S | 4/2019 | Pinazzo et al. |
| D828,935 S | 9/2018 | Hochmuth | D847,027 S | 4/2019 | Loeb |
| D829,622 S | 10/2018 | Jacob | D847,028 S | 4/2019 | Loeb |
| D830,241 S | 10/2018 | Kozub | D847,038 S | 4/2019 | Loeb |
| D830,242 S | 10/2018 | Zipfel | D847,041 S | 4/2019 | Blanski et al. |
| D830,252 S | 10/2018 | Swanseger | D847,042 S | 4/2019 | Pinazzo et al. |
| D830,258 S | 10/2018 | McMahan et al. | D847,043 S | 4/2019 | Kozub |
| D830,261 S | 10/2018 | Jacob | D847,044 S | 4/2019 | Zipfel |
| D830,589 S | 10/2018 | Henriques | D847,045 S | 4/2019 | Whitla et al. |
| D832,752 S | 11/2018 | Lee | D847,046 S | 4/2019 | Whitla et al. |
| D835,003 S | 12/2018 | Thompson et al. | D847,047 S | 4/2019 | Krieg et al. |
| D835,012 S | 12/2018 | Smith et al. | D847,390 S | 4/2019 | Koo et al. |
| D837,105 S | 1/2019 | Loeb | D847,391 S | 4/2019 | Pinazzo et al. |
| D837,109 S | 1/2019 | Kozub et al. | D847,392 S | 4/2019 | Zipfel |
| D837,424 S | 1/2019 | Whitla et al. | D847,699 S | 5/2019 | Kozub |
| D838,015 S | 1/2019 | McMahan et al. | D847,700 S | 5/2019 | Kozub |
| D838,016 S | 1/2019 | McMahan et al. | D847,701 S | 5/2019 | Kozub |
| D838,390 S | 1/2019 | McMahan et al. | D847,702 S | 5/2019 | Zipfel |
| D838,391 S | 1/2019 | McMahan et al. | D847,703 S | 5/2019 | Kozub |
| D839,157 S | 1/2019 | Smith et al. | D847,704 S | 5/2019 | Zipfel |
| D839,163 S | 1/2019 | Pinazzo et al. | D847,705 S | 5/2019 | Zipfel |
| D839,164 S | 1/2019 | Zipfel | D847,707 S | 5/2019 | Park Cheng et al. |
| D839,460 S | 1/2019 | Zipfel et al. | D847,714 S | 5/2019 | Mack et al. |
| D840,068 S | 2/2019 | Zipfel et al. | D848,315 S | 5/2019 | Koo et al. |
| D840,069 S | 2/2019 | Perkins | D848,318 S | 5/2019 | McMahan et al. |
| D840,285 S | 2/2019 | Mack et al. | D848,320 S | 5/2019 | Pinazzo et al. |
| D840,286 S | 2/2019 | Mack et al. | D848,322 S | 5/2019 | Mack et al. |
| D840,293 S | 2/2019 | Koo et al. | D848,323 S | 5/2019 | Mack et al. |
| D840,302 S | 2/2019 | O'Donnell et al. | D848,324 S | 5/2019 | Thurber et al. |
| D840,303 S | 2/2019 | Park Cheng | D848,325 S | 5/2019 | Thurber et al. |
| D840,306 S | 2/2019 | Kozub | D848,647 S | 5/2019 | Kozub |
| D840,565 S | 2/2019 | Whitla et al. | D848,908 S | 5/2019 | Krieg |
| D840,570 S | 2/2019 | Kim et al. | D848,909 S | 5/2019 | Lee |
| D840,571 S | 2/2019 | Zipfel et al. | D848,911 S | 5/2019 | De Leon |
| D840,572 S | 2/2019 | Perkins | D848,915 S | 5/2019 | Izard |
| D840,885 S | 2/2019 | Park Cheng | D849,627 S | 5/2019 | Zipfel |
| | | | D849,629 S | 5/2019 | De Leon |
| | | | D849,630 S | 5/2019 | De Leon |
| | | | D850,341 S | 6/2019 | Riggs et al. |
| | | | D850,989 S | 6/2019 | Kozub |

(56)

References Cited

U.S. PATENT DOCUMENTS

| | | | | | |
|------------|--------|------------------|------------|---------|-------------------|
| D851,002 S | 6/2019 | Kozub | D858,820 S | 9/2019 | McMahan et al. |
| D851,541 S | 6/2019 | Pinazzo | D858,821 S | 9/2019 | Park |
| D851,542 S | 6/2019 | Mack | D858,822 S | 9/2019 | Whitla et al. |
| D851,547 S | 6/2019 | Mack et al. | D858,823 S | 9/2019 | Zipfel |
| D851,548 S | 6/2019 | Mack et al. | D858,824 S | 9/2019 | Pinazzo et al. |
| D851,549 S | 6/2019 | Mack et al. | D859,229 S | 9/2019 | Karras et al. |
| D851,550 S | 6/2019 | Mack et al. | D859,230 S | 9/2019 | Parkinson et al. |
| D851,551 S | 6/2019 | Mack et al. | D859,231 S | 9/2019 | Wilkins et al. |
| D851,552 S | 6/2019 | Mack et al. | D859,232 S | 9/2019 | Izard et al. |
| D851,555 S | 6/2019 | Whitla et al. | D859,233 S | 9/2019 | Izard et al. |
| D851,556 S | 6/2019 | Thurber et al. | D859,237 S | 9/2019 | Koo et al. |
| D851,557 S | 6/2019 | Thurber et al. | D859,238 S | 9/2019 | Smith et al. |
| D851,558 S | 6/2019 | Thurber et al. | D859,239 S | 9/2019 | Sullivan et al. |
| D851,559 S | 6/2019 | Thurber et al. | D859,246 S | 9/2019 | Thurber et al. |
| D851,560 S | 6/2019 | Yong et al. | D859,248 S | 9/2019 | Wilkins et al. |
| D851,561 S | 6/2019 | Yong et al. | D859,252 S | 9/2019 | Krieg |
| D852,093 S | 6/2019 | Kozub | D859,253 S | 9/2019 | Izard |
| D852,094 S | 6/2019 | Zipfel | D859,254 S | 9/2019 | Izard |
| D852,096 S | 6/2019 | Kozub | D859,707 S | 9/2019 | McMahan et al. |
| D852,099 S | 6/2019 | Loeb | D859,708 S | 9/2019 | Kozub |
| D852,389 S | 6/2019 | Koo et al. | D859,709 S | 9/2019 | Zipfel |
| D852,393 S | 6/2019 | Whitla et al. | D860,075 S | 9/2019 | Riggs et al. |
| D853,903 S | 7/2019 | Loeb | D860,076 S | 9/2019 | Bartels et al. |
| D853,904 S | 7/2019 | Koo et al. | D860,077 S | 9/2019 | Riggs et al. |
| D853,924 S | 7/2019 | Riggs et al. | D860,078 S | 9/2019 | O'Donnell et al. |
| D854,462 S | 7/2019 | Lee | D860,079 S | 9/2019 | Sullivan et al. |
| D854,471 S | 7/2019 | Lee | D860,085 S | 9/2019 | Koo et al. |
| D854,977 S | 7/2019 | Parkinson et al. | D860,489 S | 9/2019 | Henriques |
| D854,979 S | 7/2019 | Krieg et al. | D860,490 S | 9/2019 | Henriques |
| D854,988 S | 7/2019 | Krieg | D862,337 S | 10/2019 | Pinazzo et al. |
| D854,991 S | 7/2019 | Whitla et al. | D863,104 S | 10/2019 | Bennion |
| D855,503 S | 8/2019 | Blanski et al. | D863,105 S | 10/2019 | Dias et al. |
| D855,504 S | 8/2019 | Lee | D863,106 S | 10/2019 | Dias et al. |
| D855,505 S | 8/2019 | Thurber et al. | D863,109 S | 10/2019 | Thurber |
| D855,507 S | 8/2019 | Blanski et al. | D863,125 S | 10/2019 | Whitla et al. |
| D855,508 S | 8/2019 | Wilkins et al. | D863,126 S | 10/2019 | Whitla et al. |
| D855,509 S | 8/2019 | Wilkins | D863,127 S | 10/2019 | Whitla et al. |
| D855,515 S | 8/2019 | Riggs et al. | D863,128 S | 10/2019 | Whitla et al. |
| D855,518 S | 8/2019 | Whitla et al. | D863,129 S | 10/2019 | Zipfel |
| D855,520 S | 8/2019 | Parkinson | D863,130 S | 10/2019 | Thurber et al. |
| D855,523 S | 8/2019 | Perkins | D863,131 S | 10/2019 | Thurber et al. |
| D855,524 S | 8/2019 | Lee | D863,132 S | 10/2019 | Thurber et al. |
| D856,201 S | 8/2019 | Blanski et al. | D863,134 S | 10/2019 | Thurber et al. |
| D856,204 S | 8/2019 | Kapitonov | D863,135 S | 10/2019 | O'Donnell et al. |
| D856,206 S | 8/2019 | De Leon | D863,136 S | 10/2019 | Blanski et al. |
| D856,242 S | 8/2019 | Blanski et al. | D863,137 S | 10/2019 | Kim et al. |
| D856,864 S | 8/2019 | Kapitonov | D863,138 S | 10/2019 | Kim et al. |
| D856,874 S | 8/2019 | Kozub | D863,140 S | 10/2019 | Wilkins et al. |
| D856,875 S | 8/2019 | Kozub | D863,141 S | 10/2019 | Zipfel |
| D856,876 S | 8/2019 | Kapitonov | D863,142 S | 10/2019 | Zipfel |
| D857,260 S | 8/2019 | Kil et al. | D863,147 S | 10/2019 | Zipfel |
| D857,567 S | 8/2019 | Blanski et al. | D863,149 S | 10/2019 | Luke et al. |
| D857,936 S | 8/2019 | Kil et al. | D863,150 S | 10/2019 | Krieg et al. |
| D857,938 S | 8/2019 | Blanski et al. | D863,152 S | 10/2019 | Kozub |
| D857,939 S | 8/2019 | Kozub | D863,154 S | 10/2019 | O'Donnell et al. |
| D857,940 S | 8/2019 | Park | D863,156 S | 10/2019 | Blanski et al. |
| D857,941 S | 8/2019 | Whitla et al. | D863,157 S | 10/2019 | Wilkins et al. |
| D857,942 S | 8/2019 | Perkins | D863,160 S | 10/2019 | Gifford et al. |
| D857,943 S | 8/2019 | Hochmuth | D863,169 S | 10/2019 | Whitla et al. |
| D857,944 S | 8/2019 | Pinazzo et al. | D863,170 S | 10/2019 | Zipfel |
| D857,945 S | 8/2019 | Smith et al. | D863,625 S | 10/2019 | Kim |
| D857,946 S | 8/2019 | Smith et al. | D863,629 S | 10/2019 | Whitla et al. |
| D857,947 S | 8/2019 | Koo et al. | D863,630 S | 10/2019 | Whitla et al. |
| D857,948 S | 8/2019 | Koo et al. | D863,662 S | 10/2019 | Yong et al. |
| D857,949 S | 8/2019 | Smith et al. | D863,664 S | 10/2019 | Kozub |
| D857,950 S | 8/2019 | Zipfel | D864,049 S | 10/2019 | Luke et al. |
| D857,951 S | 8/2019 | Whitla et al. | D864,050 S | 10/2019 | Luke et al. |
| D857,952 S | 8/2019 | Smith et al. | D864,051 S | 10/2019 | Luke et al. |
| D858,373 S | 9/2019 | Blanski et al. | D864,052 S | 10/2019 | Zipfel |
| D858,377 S | 9/2019 | Riggs et al. | D864,053 S | 10/2019 | Zipfel |
| D858,813 S | 9/2019 | Datta | D864,057 S | 10/2019 | Krieg et al. |
| D858,814 S | 9/2019 | Burns | D864,065 S | 10/2019 | Pinazzo et al. |
| D858,817 S | 9/2019 | Henriques | D864,441 S | 10/2019 | Perkins |
| D858,818 S | 9/2019 | McMahan et al. | D866,413 S | 11/2019 | Luke et al. |
| D858,819 S | 9/2019 | McMahan et al. | D867,232 S | 11/2019 | Izard |
| | | | D867,939 S | 11/2019 | Yong et al. |
| | | | D867,947 S | 11/2019 | Park Cheng et al. |
| | | | D867,949 S | 11/2019 | Thurber et al. |
| | | | D867,951 S | 11/2019 | Izard |

(56)

References Cited

U.S. PATENT DOCUMENTS

D868,302 S 11/2019 Hochmuth
 D868,357 S 11/2019 De Leon
 D868,639 S 12/2019 Wilkins et al.
 D868,650 S 12/2019 Gifford
 D868,651 S 12/2019 Gifford
 D868,652 S 12/2019 Gifford
 D868,656 S 12/2019 De Leon
 D868,660 S 12/2019 De Leon
 D868,756 S 12/2019 Song et al.
 D869,015 S 12/2019 Pinazzo et al.
 D869,026 S 12/2019 Zipfel
 D869,027 S 12/2019 Zipfel
 D869,028 S 12/2019 Zipfel
 D870,001 S 12/2019 Mai
 D870,619 S 12/2019 Gifford
 D873,726 S 1/2020 Zipfel
 D873,733 S 1/2020 Kozub
 D873,735 S 1/2020 Park Cheng et al.
 D873,740 S 1/2020 Zipfel
 D873,745 S 1/2020 Ruiz
 D873,751 S 1/2020 De Leon
 D874,029 S 1/2020 Mack et al.
 D874,030 S 1/2020 Mack et al.
 D874,033 S 1/2020 Park Cheng et al.
 D874,034 S 1/2020 Schmeckpeper
 D874,035 S 1/2020 Park Cheng et al.
 D874,053 S 1/2020 Zipfel
 D874,362 S 2/2020 Izard
 D874,693 S 2/2020 Blanski et al.
 D874,697 S 2/2020 Schmeckpeper
 D875,281 S 2/2020 Schmeckpeper
 D876,690 S 2/2020 Schmeckpeper
 D876,989 S 3/2020 Karras
 D877,001 S 3/2020 Izard
 D877,002 S 3/2020 Izard
 D877,003 S 3/2020 Izard
 D877,004 S 3/2020 Wilkins et al.
 D877,005 S 3/2020 Luke et al.

D877,006 S 3/2020 Luke et al.
 D877,007 S 3/2020 Zipfel
 D877,009 S 3/2020 Luke et al.
 D877,369 S 3/2020 Thurber et al.
 D877,376 S 3/2020 Cheng et al.
 D877,377 S 3/2020 Cheng et al.
 D877,941 S 3/2020 Thurber et al.
 D880,382 S 4/2020 Izard
 D881,083 S 4/2020 Blanski et al.
 D881,087 S 4/2020 Luke et al.
 D882,466 S 4/2020 Yong et al.
 D883,155 S 5/2020 Izard
 D884,939 S 5/2020 Kozub
 D885,261 S 5/2020 Zipfel
 D885,265 S 5/2020 Zipfel
 D885,270 S 5/2020 Zipfel
 D885,618 S 5/2020 Mack et al.
 D887,307 S 6/2020 Blanski et al.
 D887,323 S 6/2020 Zipfel
 D887,329 S 6/2020 Zipfel
 D887,591 S 6/2020 Mack et al.
 D887,596 S 6/2020 Pinazzo et al.
 D888,635 S 6/2020 Zipfel
 D889,331 S 7/2020 O'Donnell et al.
 D892,000 S 8/2020 De Leon
 D892,003 S 8/2020 Zipfel
 D894,059 S 8/2020 Mai
 D894,060 S 8/2020 Izard
 D894,061 S 8/2020 Zipfel
 D894,438 S 8/2020 Park Cheng et al.
 D894,439 S 8/2020 Izard
 D894,440 S 8/2020 Koo et al.
 D894,441 S 8/2020 Koo et al.
 D894,801 S 9/2020 Zipfel
 D895,859 S 9/2020 Izard
 D897,013 S 9/2020 Cheng et al.
 D897,255 S 9/2020 Zipfel
 D924,743 S * 7/2021 Kumar D12/169
 D924,747 S * 7/2021 Hunwick D12/169
 D924,750 S * 7/2021 Buller D12/169

* cited by examiner

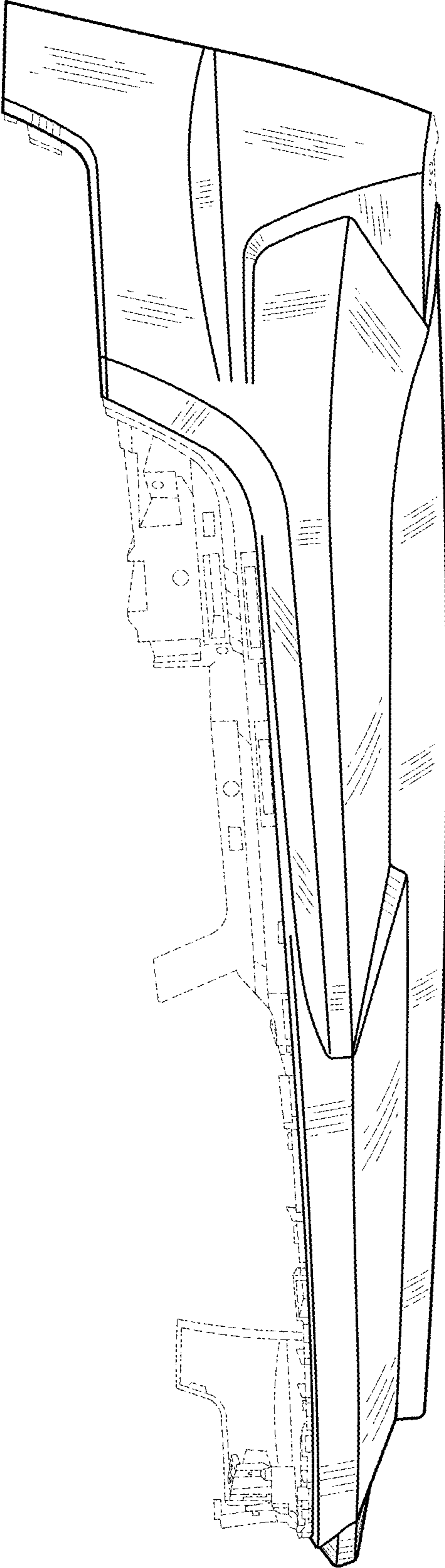

FIG - 1

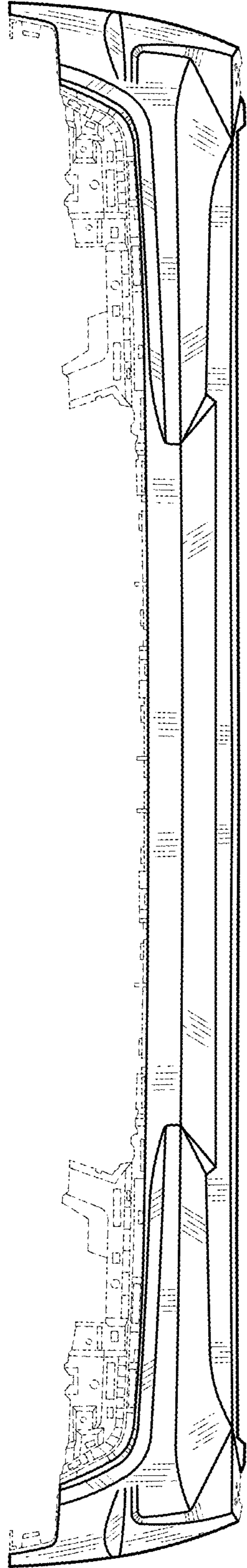

FIG - 2

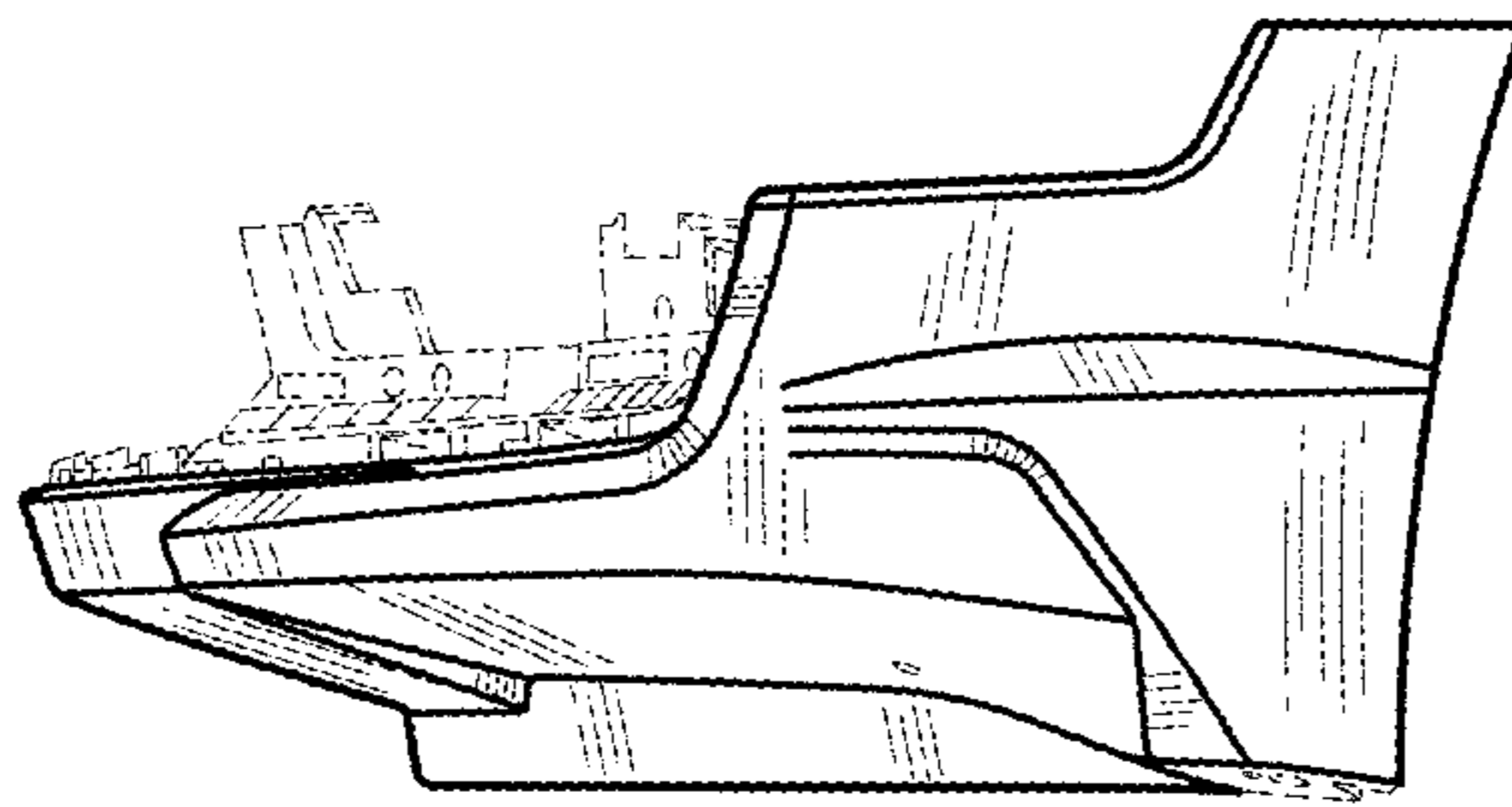

FIG - 3

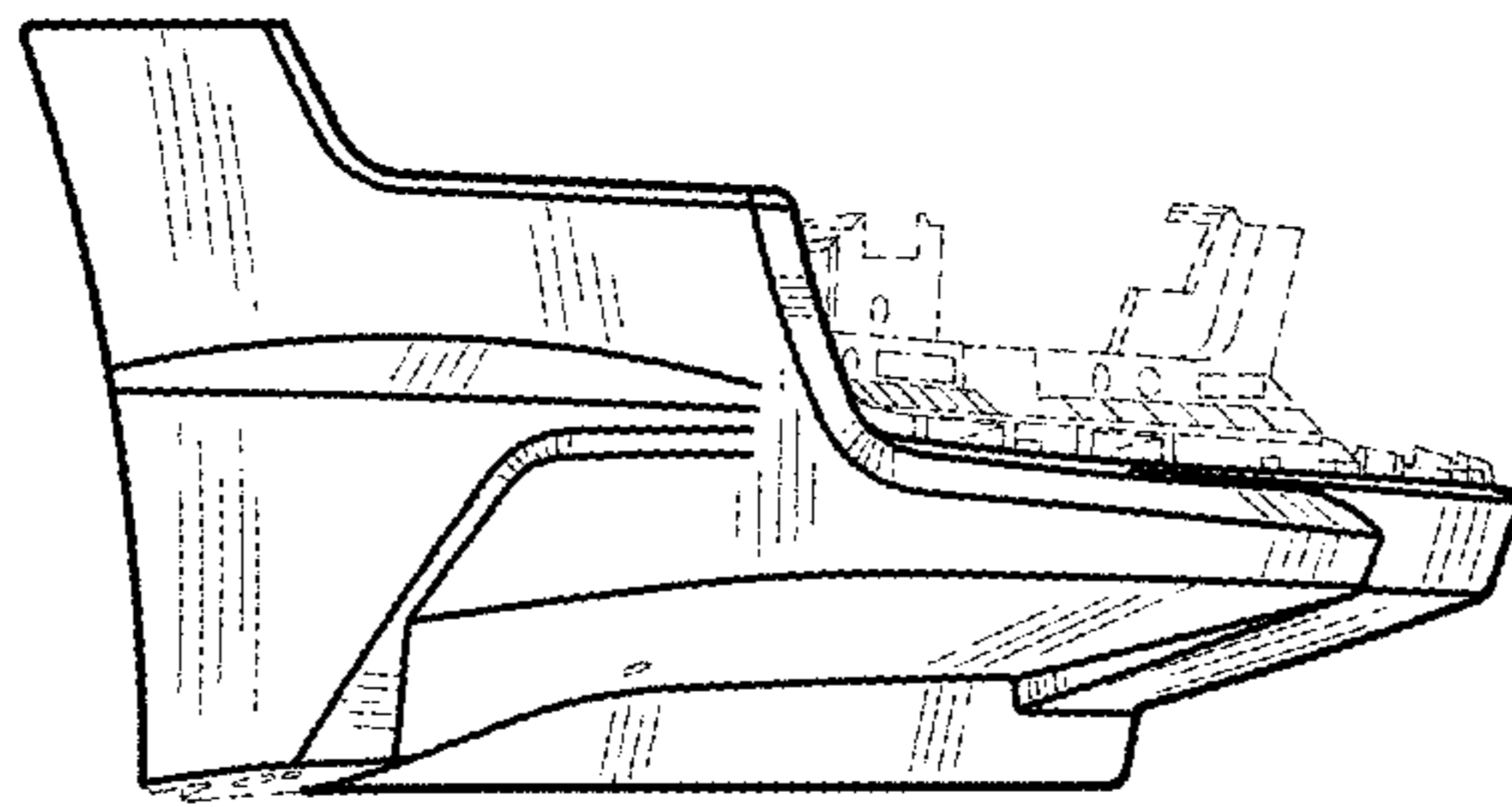

FIG - 4

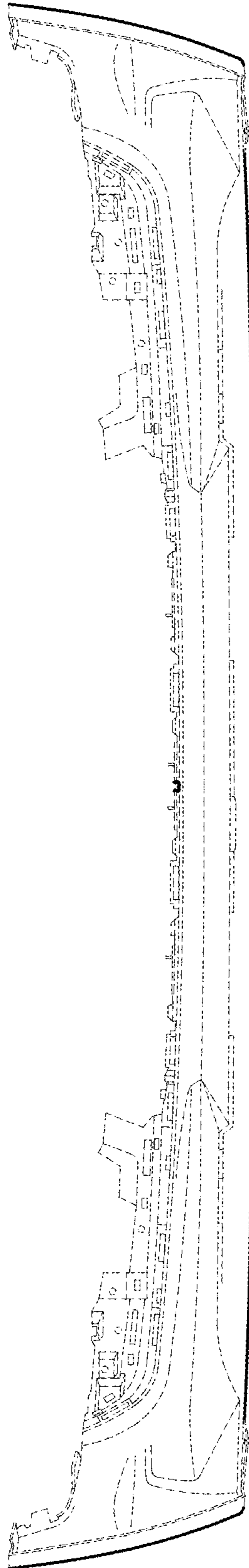

FIG - 5

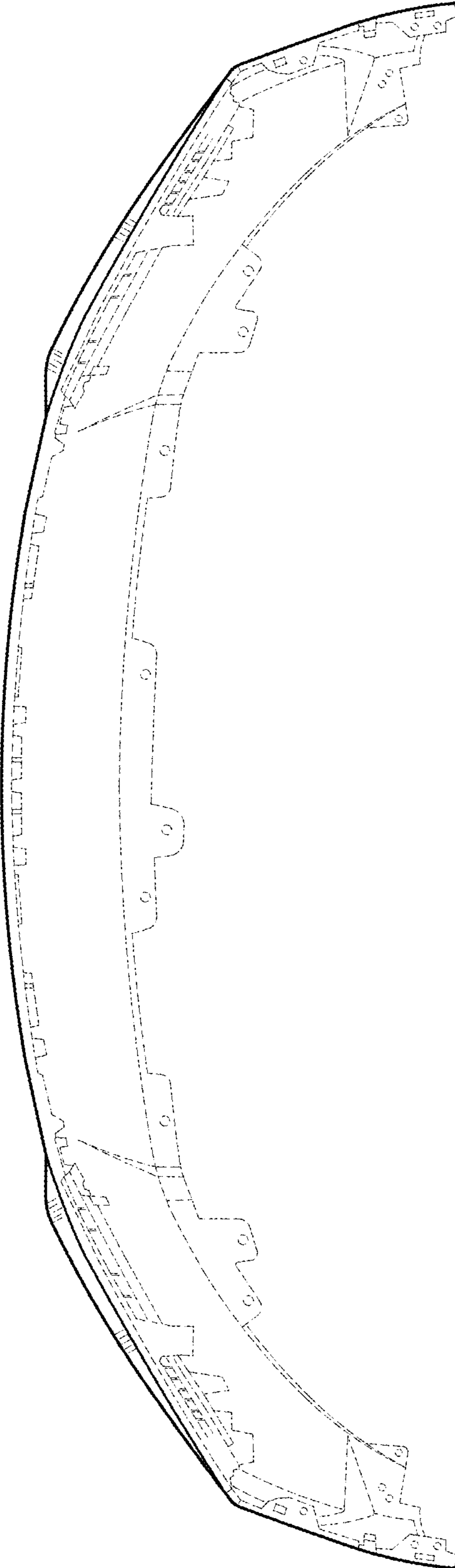

FIG - 6

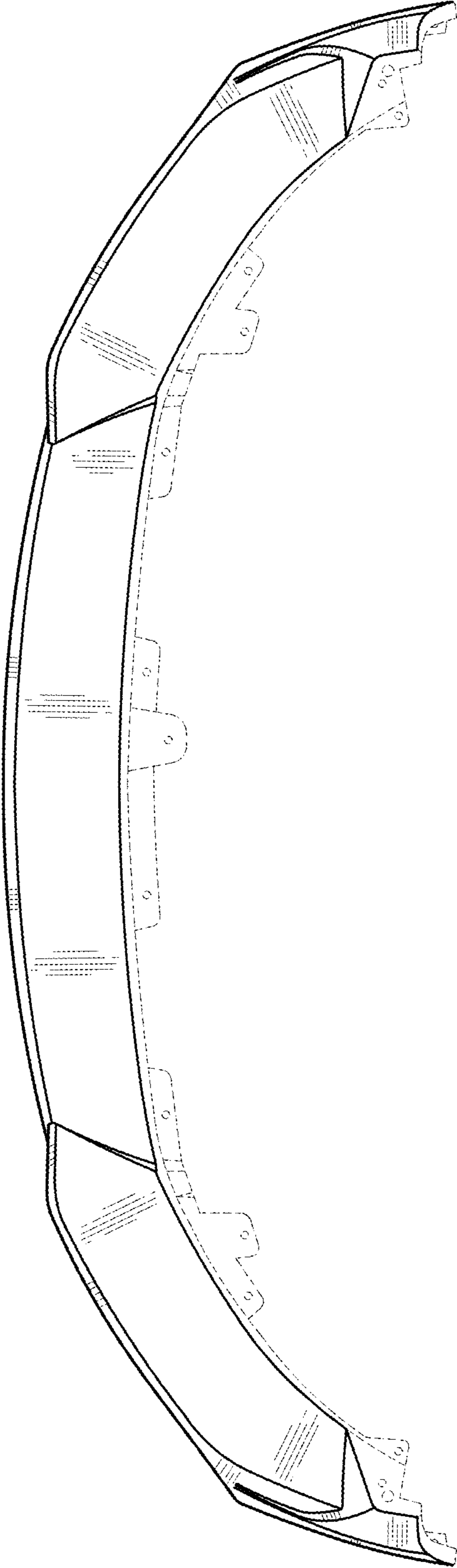

FIG - 7