



US00D960729S

(12) **United States Design Patent**  
**Lee**

(10) **Patent No.:** **US D960,729 S**  
(45) **Date of Patent:** **\*\* Aug. 16, 2022**

(54) **COVER FOR TRACKING DEVICE OR THE LIKE**

(71) Applicant: **ELAGO CO. LTD**, Goyang-si (KR)

(72) Inventor: **Chanwoo Lee**, Goyang-si (KR)

(73) Assignee: **elago CO. LTD**, Goyang-si (KR)

(\*\*) Term: **15 Years**

(21) Appl. No.: **29/796,721**

(22) Filed: **Jun. 25, 2021**

(51) **LOC (13) Cl.** ..... **10-04**

(52) **U.S. Cl.**  
USPC ..... **D10/74**

(58) **Field of Classification Search**

USPC ..... D10/38, 32, 31, 70; D14/203.5, 203.1,  
D14/203.6, 344, 471; D3/208  
CPC ..... A45C 11/00; A45C 2011/002; A45C  
2013/026; A45C 2011/003; A45C 11/182;  
A45C 11/38; A45C 13/18; A45C  
2011/001; A45C 2200/15; A45C 13/42;  
A45C 13/02; A45C 13/10; A45C 13/34;  
A45C 5/00; A45C 5/02; A45C 13/008;  
A45C 2013/025; A45C 2013/028

See application file for complete search history.

(56) **References Cited**

U.S. PATENT DOCUMENTS

D529,404 S *	10/2006	Eden	.....	D10/70
7,230,539 B2	6/2007	Klein		
D575,649 S	8/2008	Scalisi et al.		
D609,213 S *	2/2010	Yeo	.....	D14/203.1
D612,361 S *	3/2010	Wright	.....	D14/203.1
D619,117 S *	7/2010	Unruh	.....	D14/496
D683,251 S	5/2013	Dumas et al.		
D686,187 S *	7/2013	Dangerfield	.....	D14/203.6
D700,080 S *	2/2014	Broadbent	.....	D10/70
D725,493 S *	3/2015	Rimanelli	.....	D10/38
D729,655 S *	5/2015	Bauer	.....	D10/70
D731,334 S *	6/2015	Fiedler	.....	D10/70

(Continued)

FOREIGN PATENT DOCUMENTS

CN	303074976	1/2015
CN	306332352	2/2021

(Continued)

OTHER PUBLICATIONS

Elago Silicone Pad Compatible with Apple AirTag Case Holder with Adhesive Stickers, Amazon, date first available: Oct. 14, 2021, (online) URL :[https://www.amazon.com/elago-Silicone-Compatible-Adhesive-Stickers/dp/B09DRCCFVV/ref=sr\\_1\\_10?](https://www.amazon.com/elago-Silicone-Compatible-Adhesive-Stickers/dp/B09DRCCFVV/ref=sr_1_10?) (Year: 2021).\*

*Primary Examiner* — George D. Kirschbaum

*Assistant Examiner* — Antoinette Martine Suiter

(74) *Attorney, Agent, or Firm* — Paratus Law Group, PLLC

(57) **CLAIM**

The ornamental design for a cover for tracking device or the like, as shown and described.

**DESCRIPTION**

FIG. 1 is a front, top, and right side perspective view of a cover for tracking device or the like, showing my design; FIG. 2 is a front view thereof; FIG. 3 is a back view thereof; FIG. 4 is a left side view and mirror image of the opposite side thereof; FIG. 5 is a top view and mirror image of the opposite side thereof; FIG. 6 is a back, top, and right side perspective view thereof; and, FIG. 7 is a front, bottom, and right side perspective view thereof in use.

The evenly spaced broken lines shown in FIG. 7 depict environment and form no part of the claimed design.

**1 Claim, 6 Drawing Sheets**

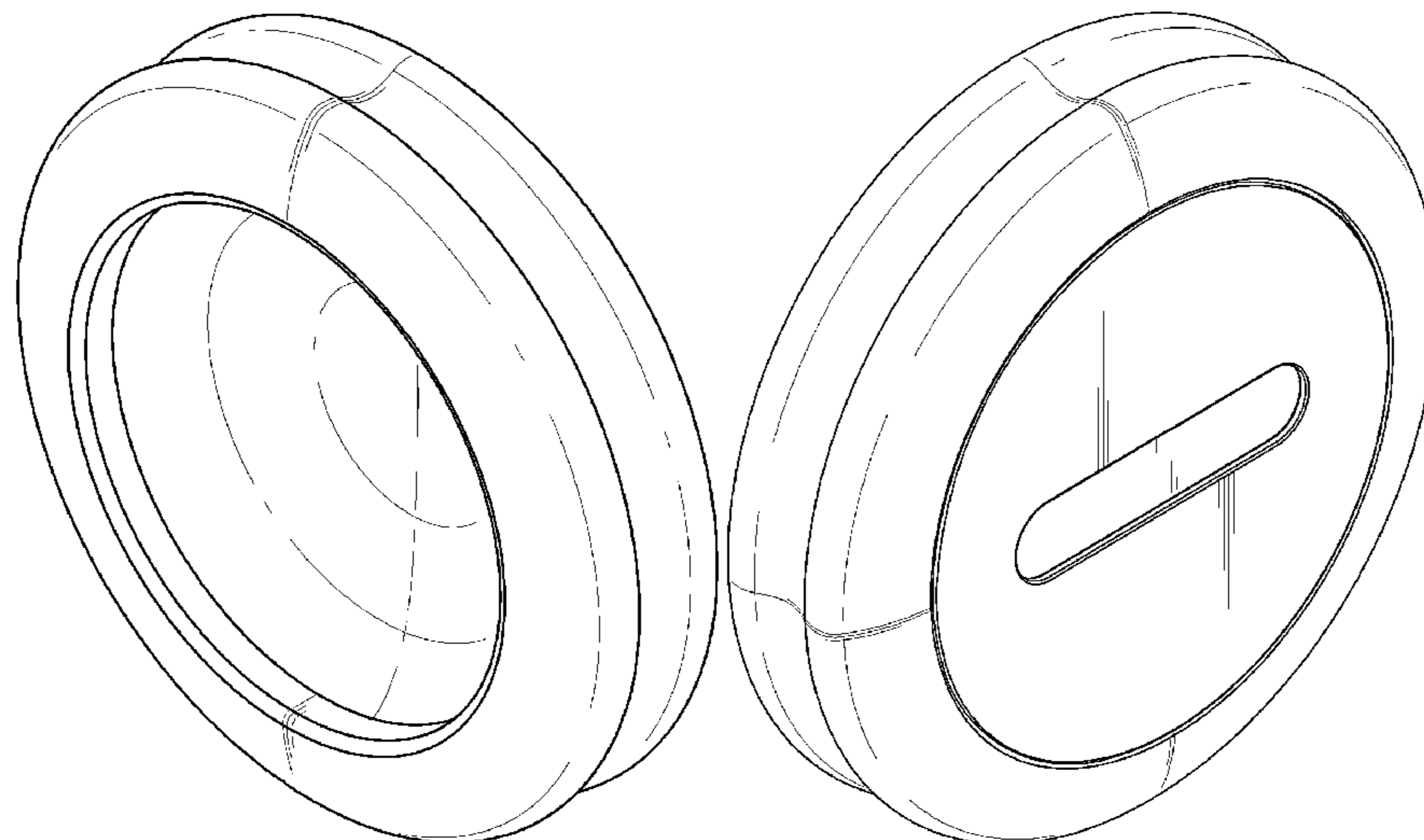

(56)

References Cited

U.S. PATENT DOCUMENTS

D736,107 S \* 8/2015 Lee ..... D10/70  
 D739,776 S 9/2015 Vu et al.  
 D751,052 S \* 3/2016 Jones ..... D14/496  
 D753,625 S \* 4/2016 Young ..... D14/496  
 D765,525 S 9/2016 Huang et al.  
 D775,233 S \* 12/2016 Beck ..... D14/496  
 D775,981 S \* 1/2017 Yu ..... D10/70  
 D779,988 S \* 2/2017 Vu ..... D10/70  
 D790,372 S \* 6/2017 Daoura ..... D10/104.1  
 D790,373 S \* 6/2017 Daoura ..... D10/104.1  
 D796,355 S \* 9/2017 Cho ..... D10/70  
 D804,531 S \* 12/2017 Beck ..... D14/496  
 D809,951 S \* 2/2018 Yang ..... D10/104.1  
 D812,501 S \* 3/2018 Kuh ..... D10/74  
 D813,273 S \* 3/2018 Mecchella ..... D14/496  
 D818,385 S 5/2018 Barovic  
 D818,853 S \* 5/2018 Golnik ..... D10/70  
 D822,717 S \* 7/2018 Lim ..... G06F 17/00  
 D14/496  
 D824,034 S 7/2018 Pushpala et al.  
 D826,748 S \* 8/2018 Kim ..... D10/70

D826,989 S \* 8/2018 Lim ..... G06F 1/1613  
 D14/511  
 D866,371 S \* 11/2019 Wheaton ..... D10/70  
 D898,596 S 10/2020 Golnik et al.  
 D901,431 S \* 11/2020 Paterson ..... D14/203.1  
 D918,072 S 5/2021 Umair et al.  
 D920,767 S \* 6/2021 Lee ..... D8/352  
 D928,150 S \* 8/2021 Maruyama ..... D21/333  
 D935,448 S \* 11/2021 Lee ..... D13/108  
 D936,505 S \* 11/2021 Umair ..... D10/70  
 2008/0135421 A1 6/2008 Raisner et al.  
 2020/0405233 A1\* 12/2020 Sakkalis ..... G04G 21/025

FOREIGN PATENT DOCUMENTS

CN	306332353	2/2021
CN	306362016	3/2021
CN	306362019	3/2021
CN	306377148	3/2021
CN	306455227	4/2021
CN	306499561	4/2021
EM	005289691-0001	* 12/2020

\* cited by examiner

FIG. 1

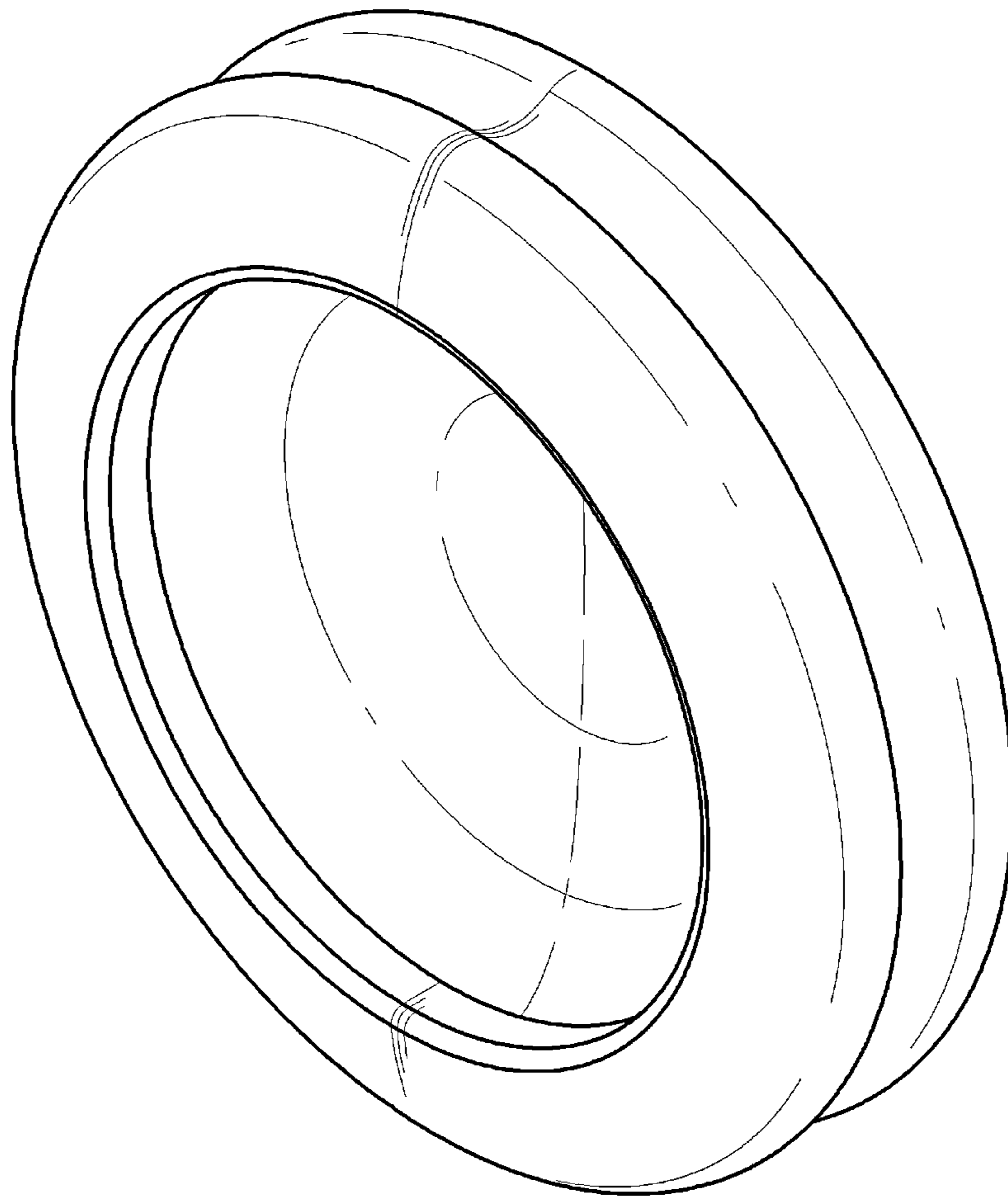

FIG. 2

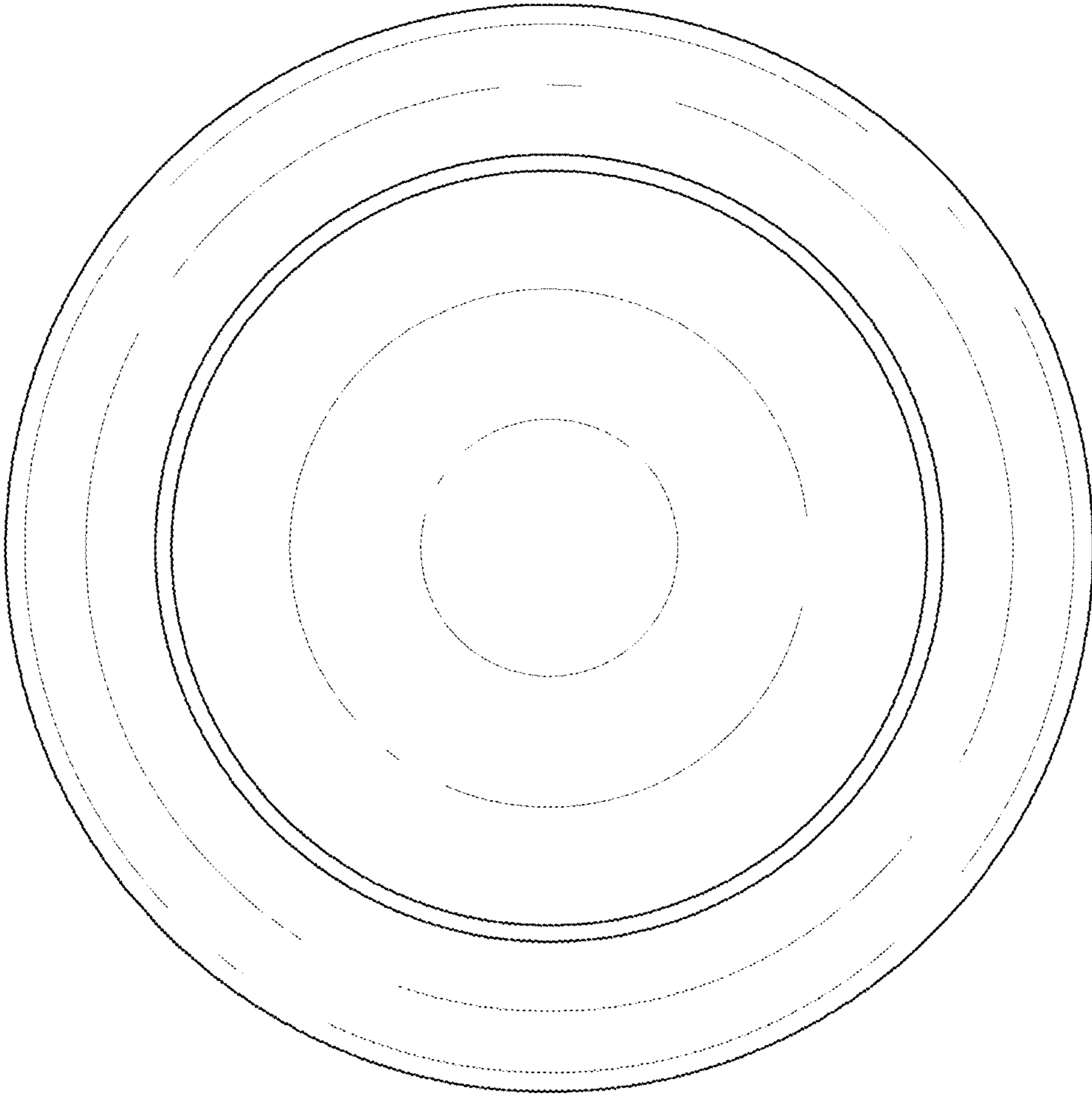

FIG. 3

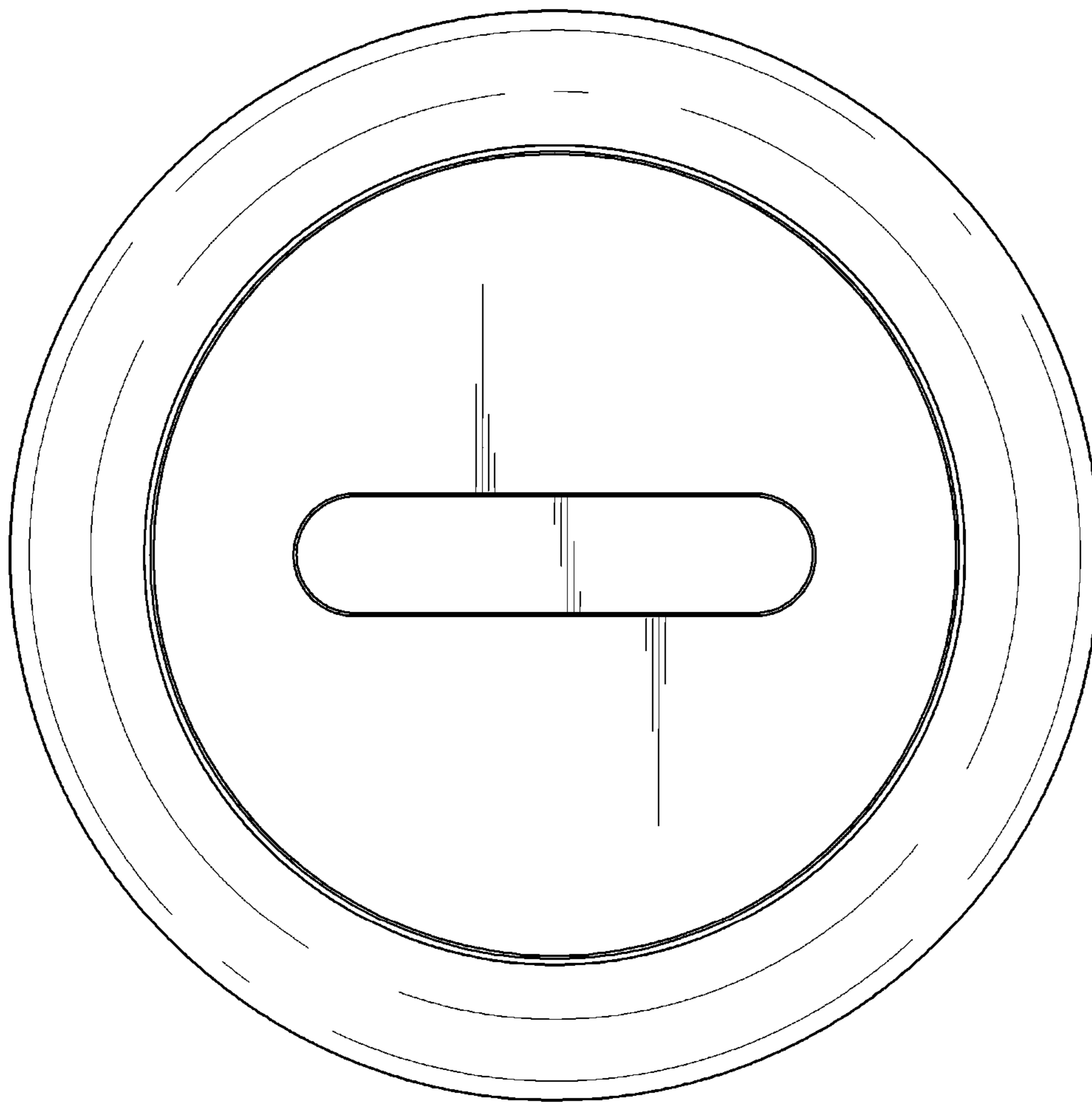

FIG. 4

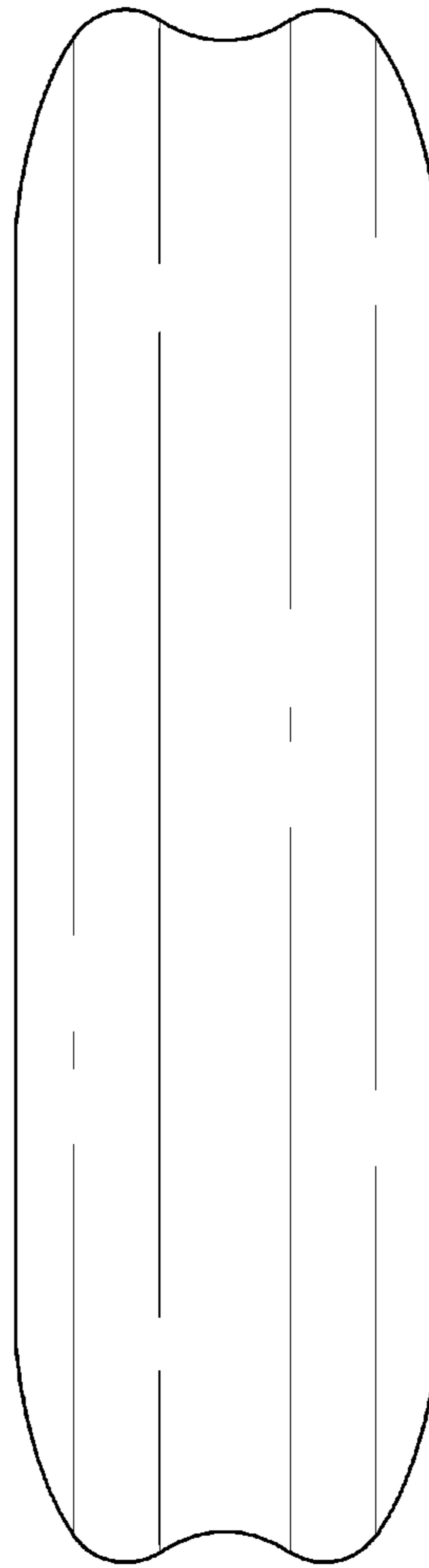

FIG. 5

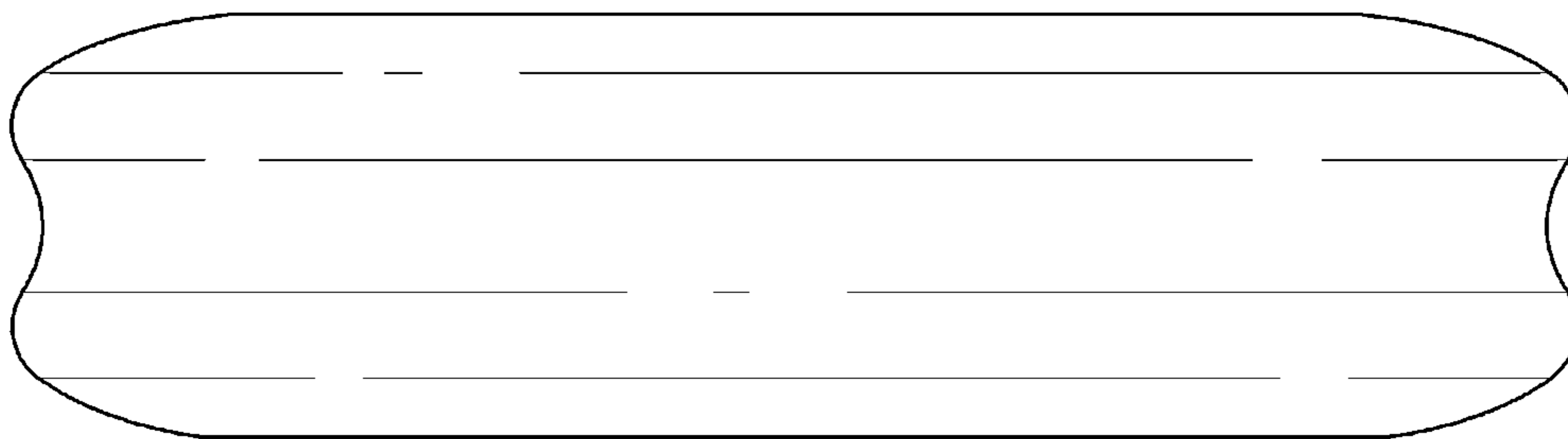

FIG. 6

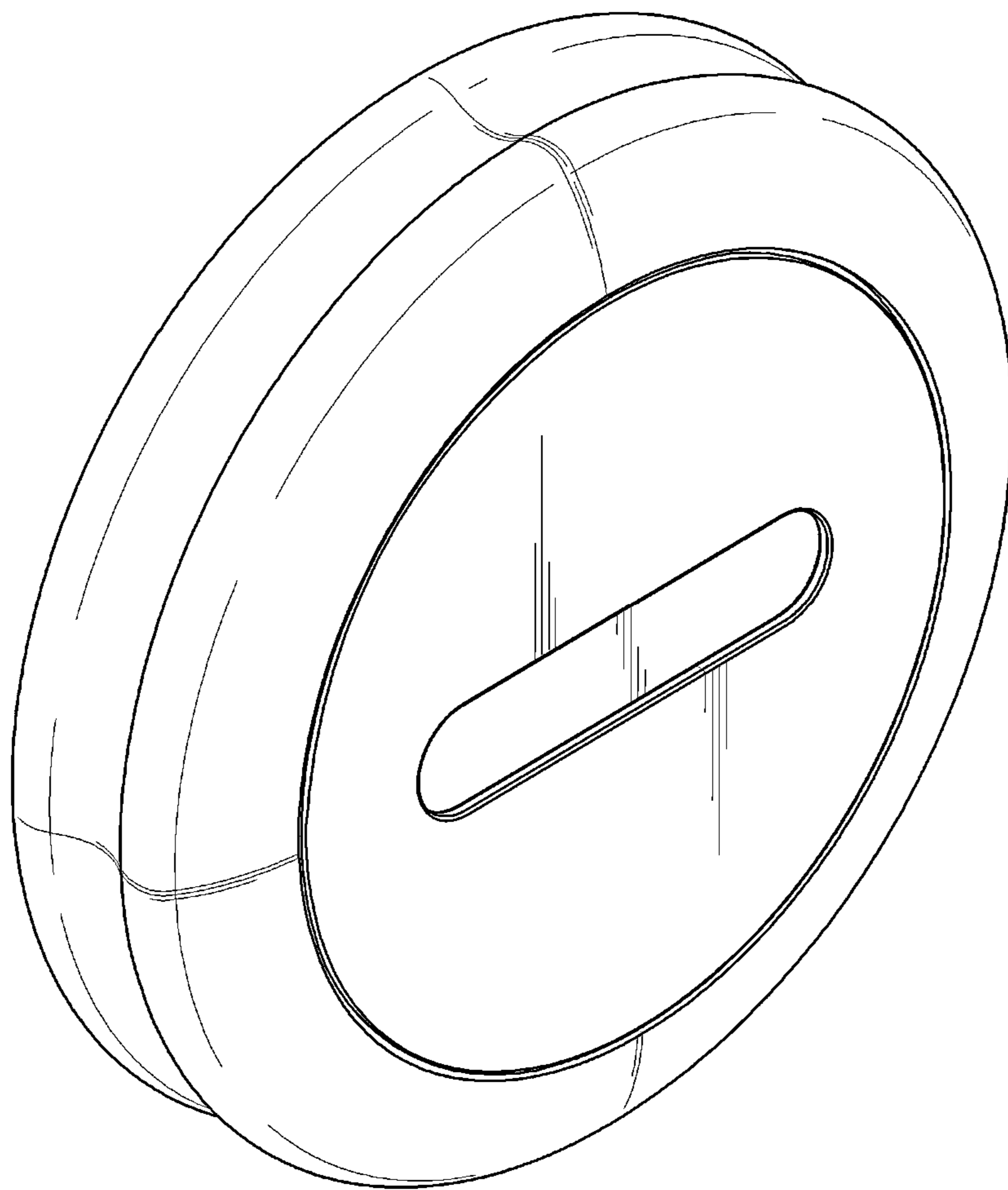

FIG. 7

