

US00D960717S

(12) **United States Design Patent**  
**Terzian**

(10) **Patent No.:** **US D960,717 S**

(45) **Date of Patent:** **\*\* Aug. 16, 2022**

(54) **PACKAGING WITH PLUSH ANIMAL**

(71) Applicant: **Rouben Terzian**, Las Vegas, NV (US)

(72) Inventor: **Rouben Terzian**, Las Vegas, NV (US)

(\*\*) Term: **15 Years**

(21) Appl. No.: **29/748,820**

(22) Filed: **Sep. 1, 2020**

(51) **LOC (13) Cl.** ..... **09-01**

(52) **U.S. Cl.**  
USPC ..... **D9/721**; D9/418; D21/611

(58) **Field of Classification Search**  
USPC ..... D9/414, 416, 418, 432, 433, 715, 721,  
D9/737

CPC .... B65D 5/422; B65D 5/4204; B65D 5/5021;  
B65D 5/6661; B65D 5/0245; B65D  
5/4229; B65D 5/2004; B65D 5/38; B65D  
5/2009; B65D 77/0433; B65D 5/28;  
B65D 5/4237; B65D 5/4258; B65D  
5/5059; B65D 85/1081; B65D 5/20;  
B65D 5/2066; B65D 5/2076; B65D 5/42

See application file for complete search history.

(56) **References Cited**

**U.S. PATENT DOCUMENTS**

- 3,324,997 A \* 6/1967 Bonanno ..... B65D 25/102  
220/756
- 3,406,816 A \* 10/1968 Green ..... B65D 5/5097  
297/118
- 4,071,140 A \* 1/1978 Rattner ..... B65D 85/18  
206/295
- D321,323 S \* 11/1991 Nakamura ..... D9/415
- 5,289,916 A \* 3/1994 Mickelberg ..... B65D 5/4204  
206/769
- 5,919,074 A \* 7/1999 Honda ..... A63H 3/50  
446/268
- D471,445 S \* 3/2003 Kohl ..... D9/415
- D590,723 S \* 4/2009 Cascone ..... D9/721

- 2002/0106624 A1\* 8/2002 Chan ..... B65D 5/4204  
206/459.1
- 2005/0218036 A1\* 10/2005 Ahn ..... B65D 5/4204  
206/769
- 2006/0118461 A1\* 6/2006 Calendrille ..... B65D 5/5213  
206/457
- 2015/0136627 A1\* 5/2015 Sabogal ..... A01N 3/00  
206/423

\* cited by examiner

*Primary Examiner* — Lauren R Calve

(74) *Attorney, Agent, or Firm* — David A. Belasco;  
Belasco Jacobs & Townsley, PC

(57) **CLAIM**

I claim the ornamental design for the packaging with plush animal, as shown and described.

**DESCRIPTION**

FIG. 1 is a perspective view of my packaging with plush animal showing my new design;  
 FIG. 2 is a front side elevational view thereof;  
 FIG. 3 is a right side elevational view thereof;  
 FIG. 4 is a left side elevational view thereof;  
 FIG. 5 is a back side elevational view thereof;  
 FIG. 6 is a top view thereof;  
 FIG. 7 is a bottom view thereof;  
 FIG. 8 is a perspective view of the packaging with plush animal according to a second embodiment of my new design;  
 FIG. 9 is a perspective view of the insert stand of the packaging with plush animal, the plush animal and outer packaging not shown for clarity of illustration;  
 FIG. 10 is a front side elevational view thereof;  
 FIG. 11 is a right side elevational view thereof;  
 FIG. 12 is a left side elevational view thereof;  
 FIG. 13 is a back side elevational view thereof;  
 FIG. 14 is a top view thereof; and,  
 FIG. 15 is a bottom view thereof.

**1 Claim, 9 Drawing Sheets**

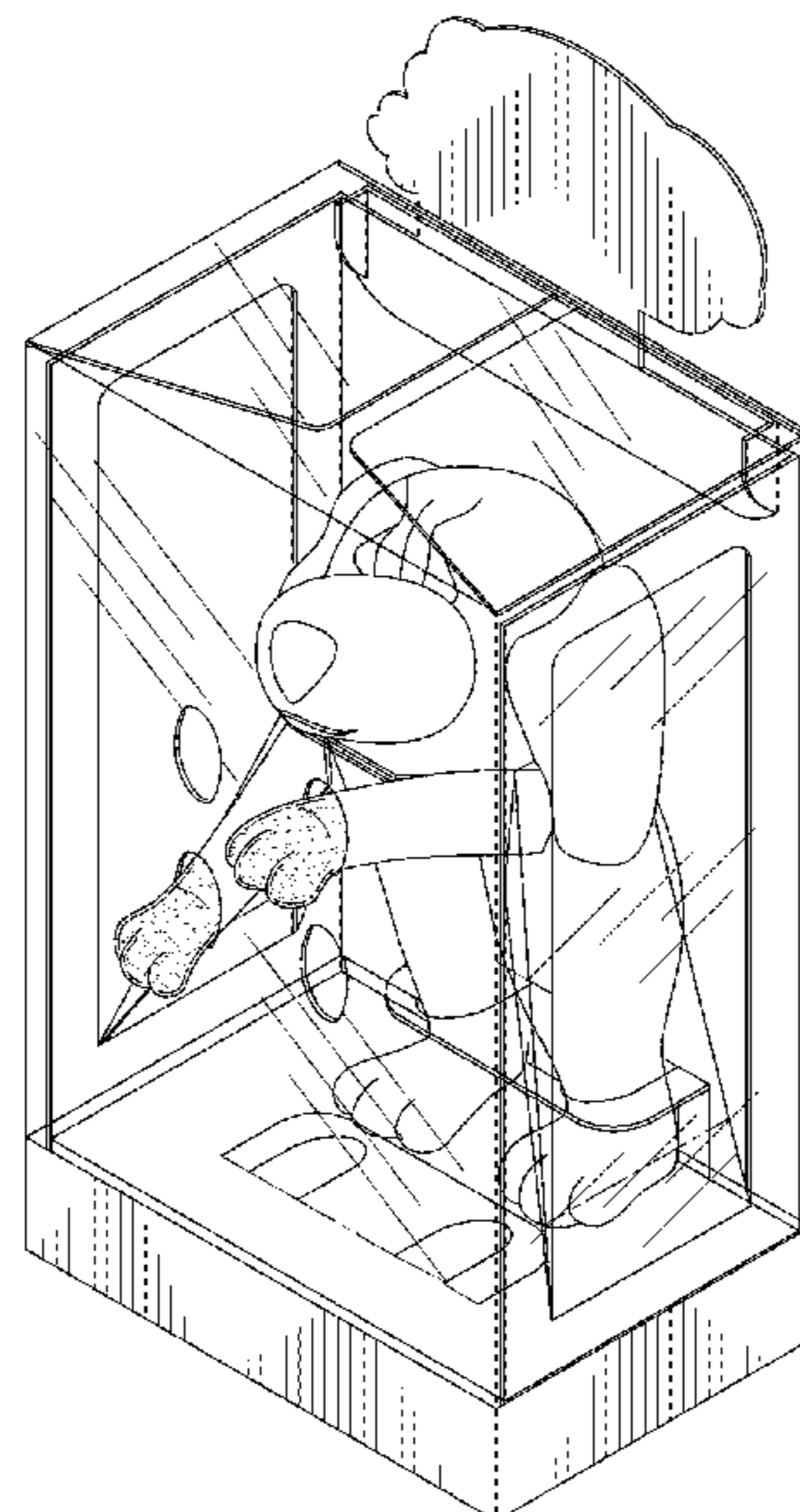

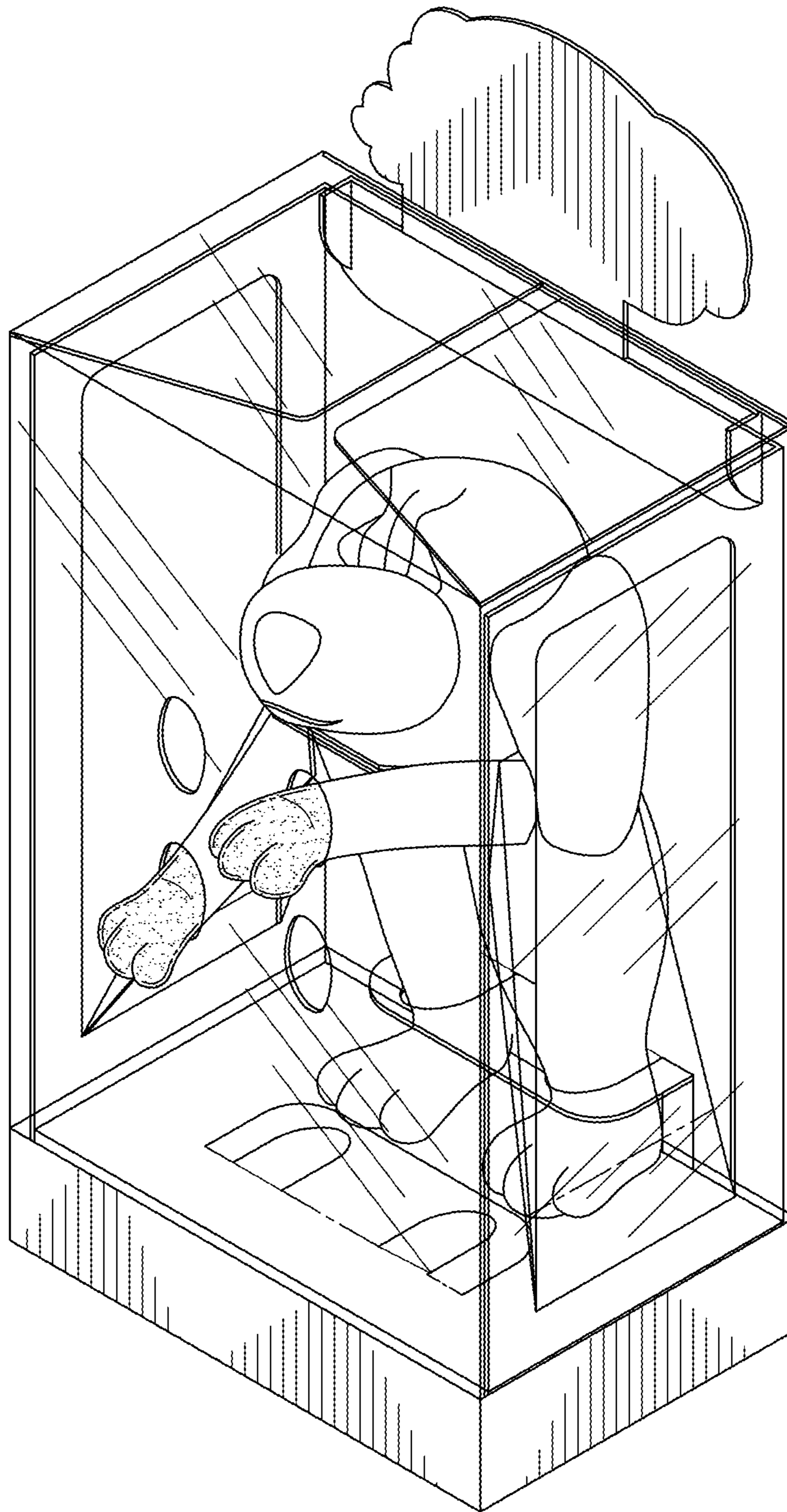

FIG. 1

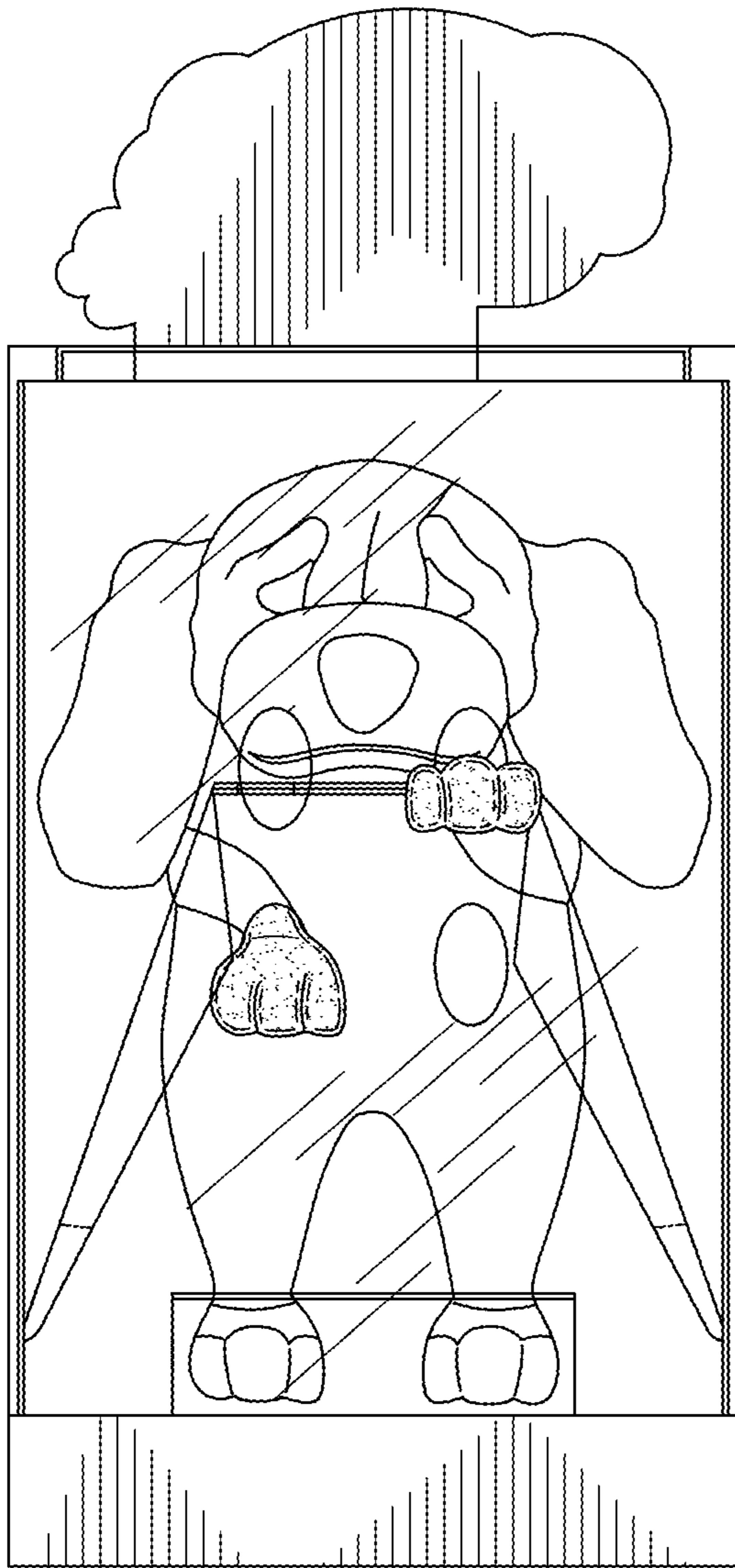

FIG. 2

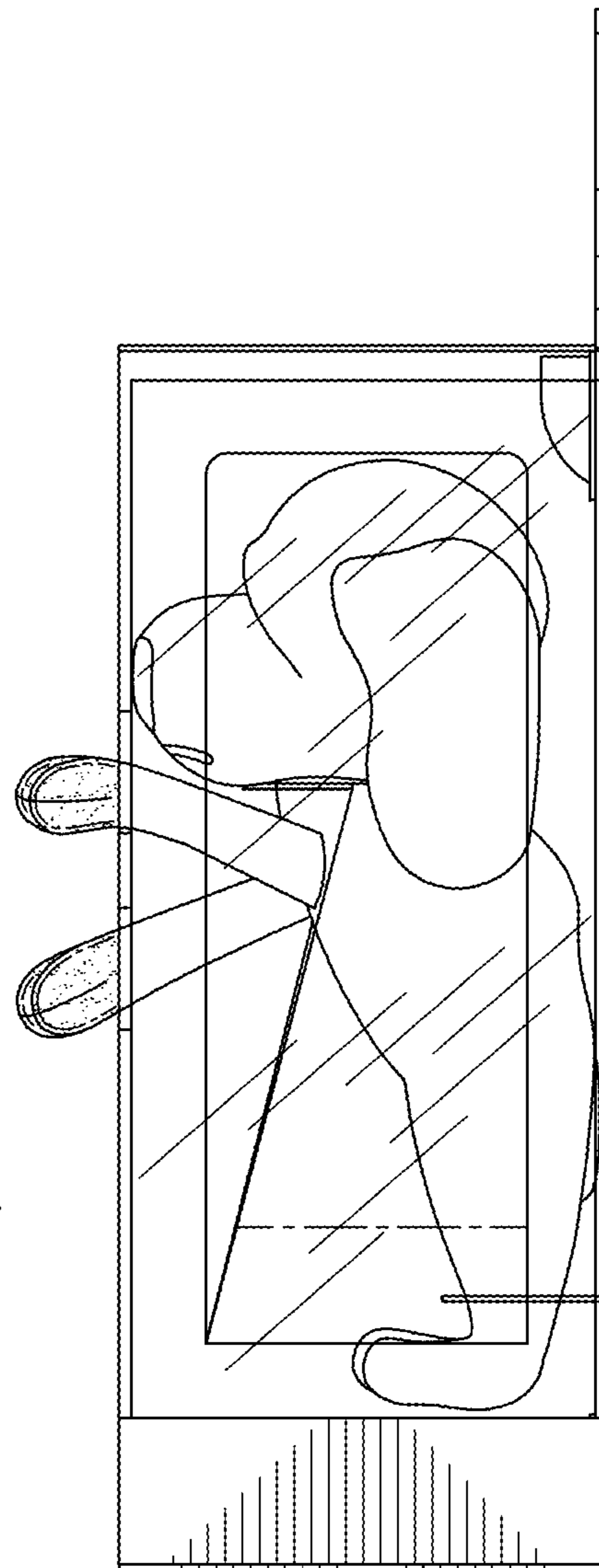

FIG. 3



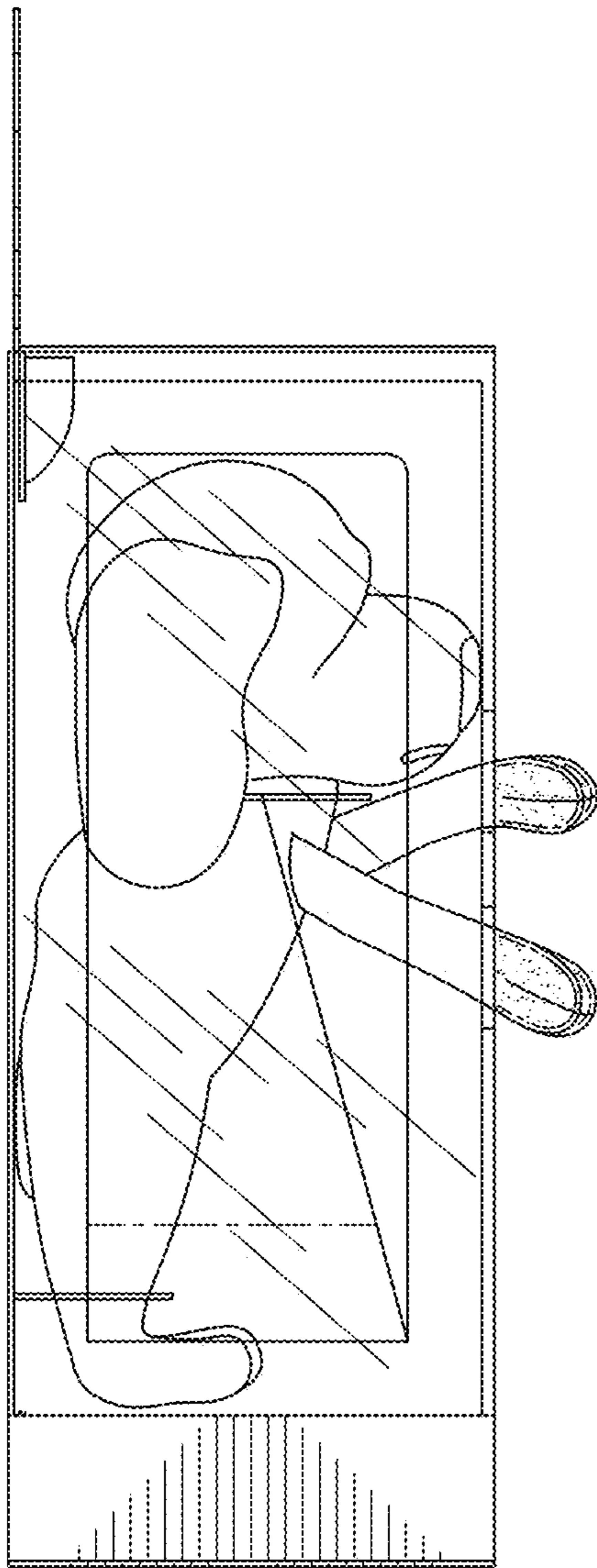

FIG. 4

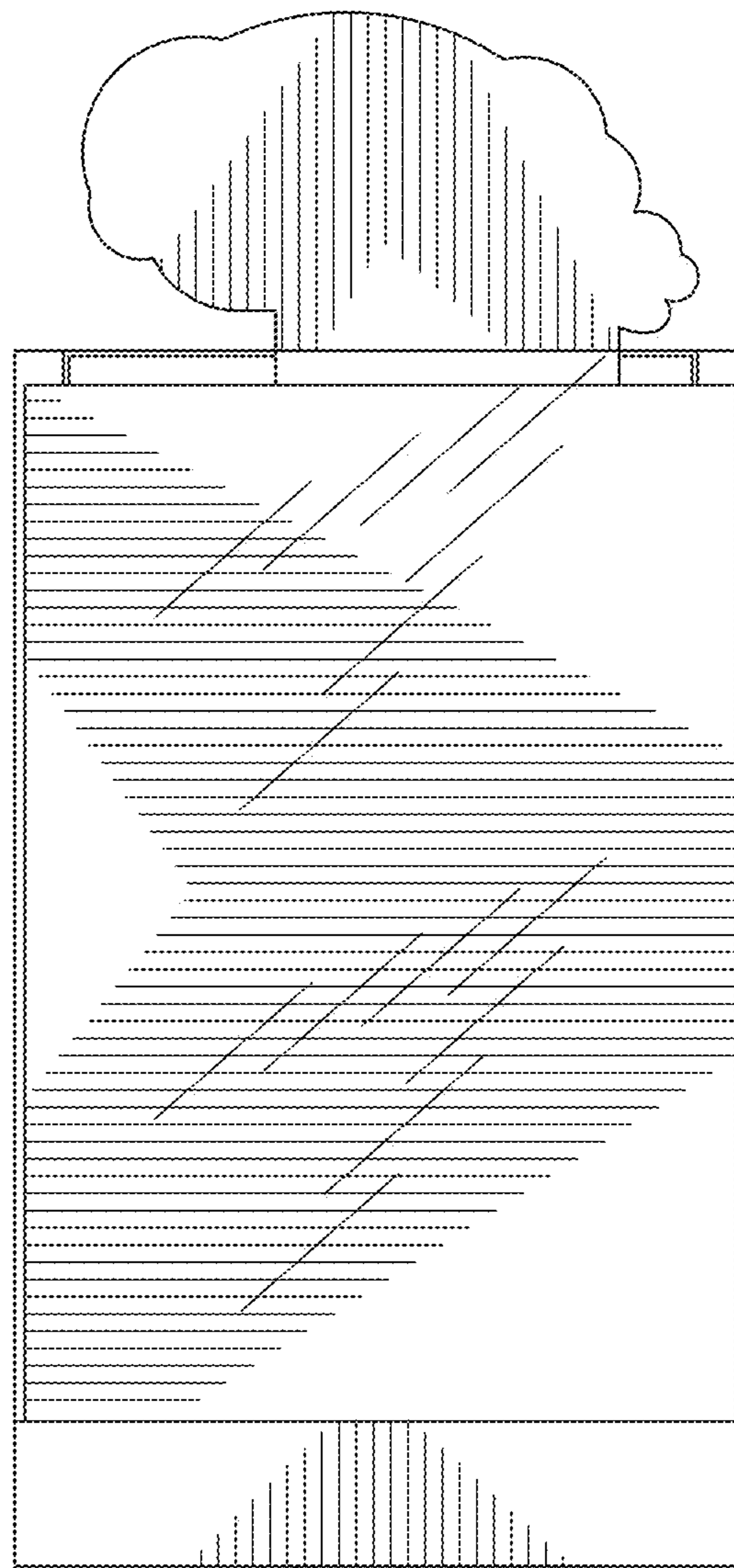

FIG. 5

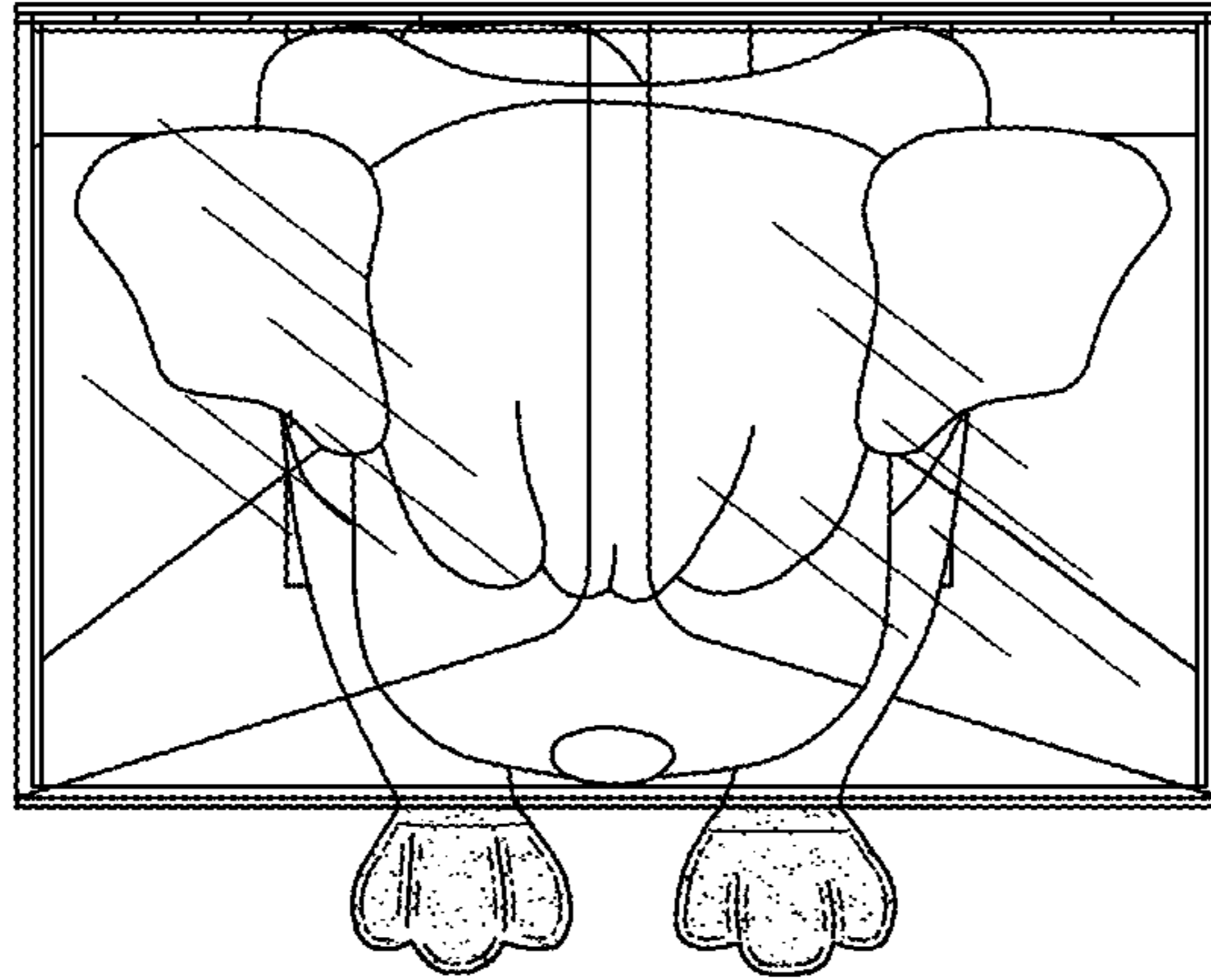

FIG. 6

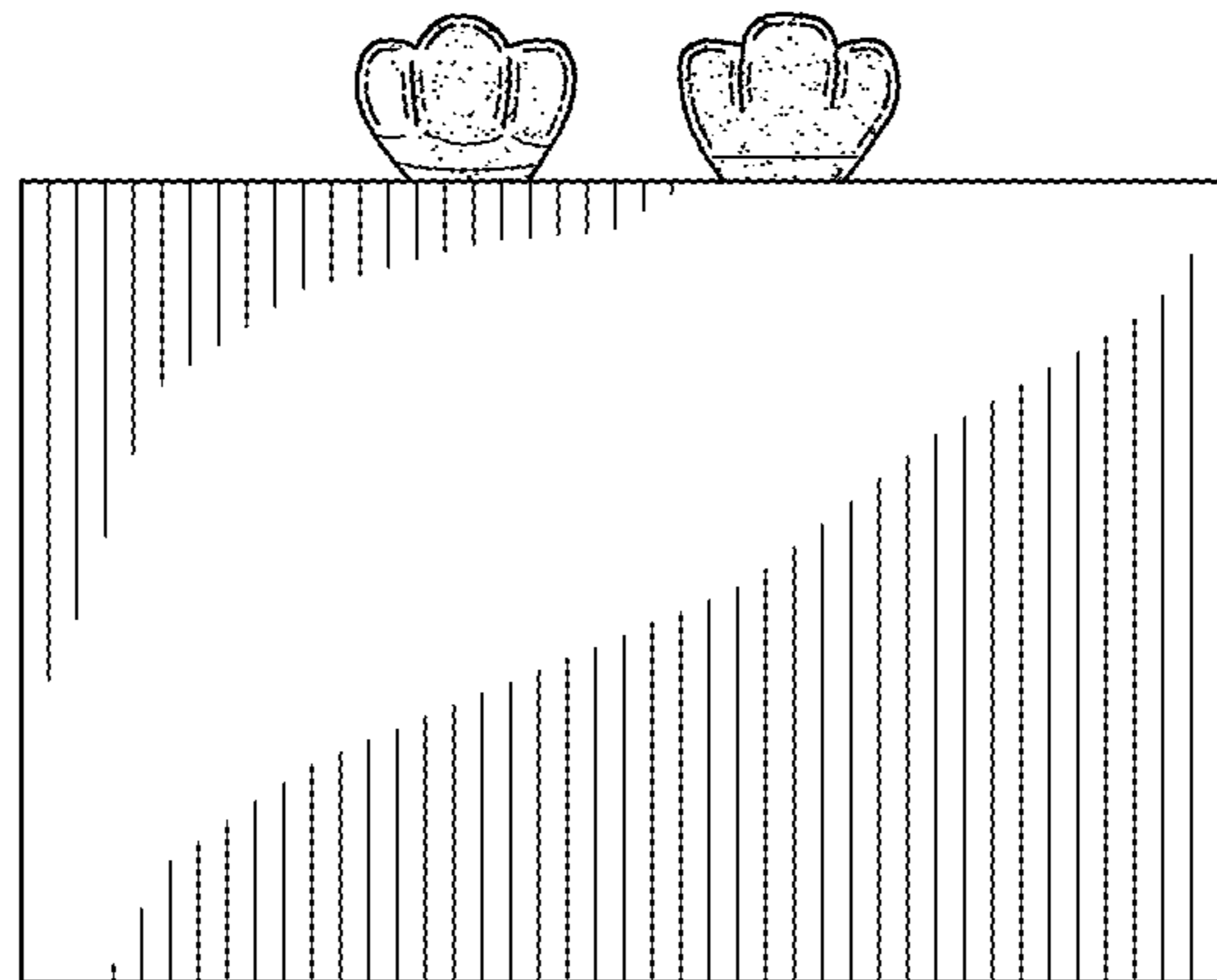

FIG. 7

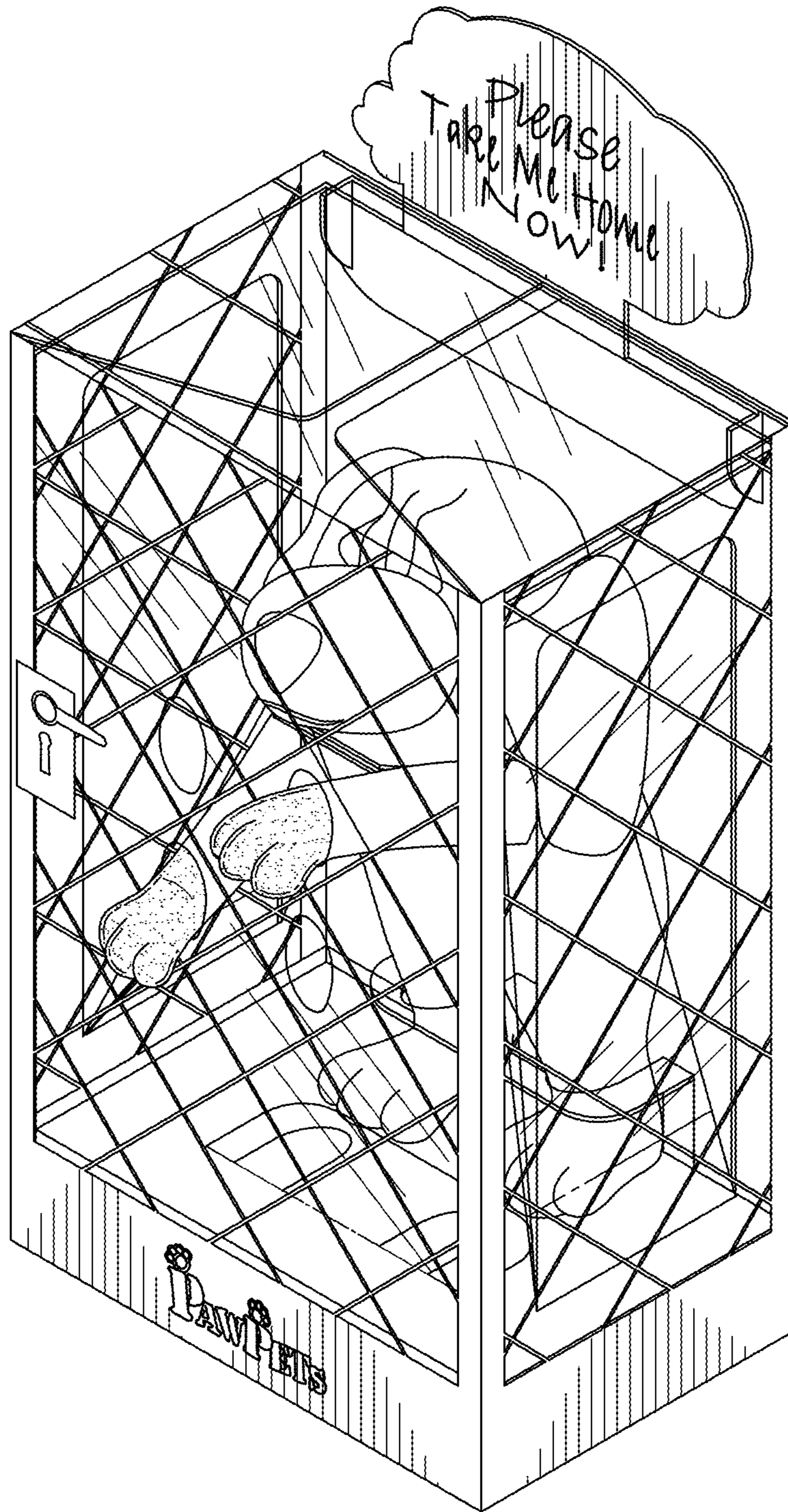

FIG. 8



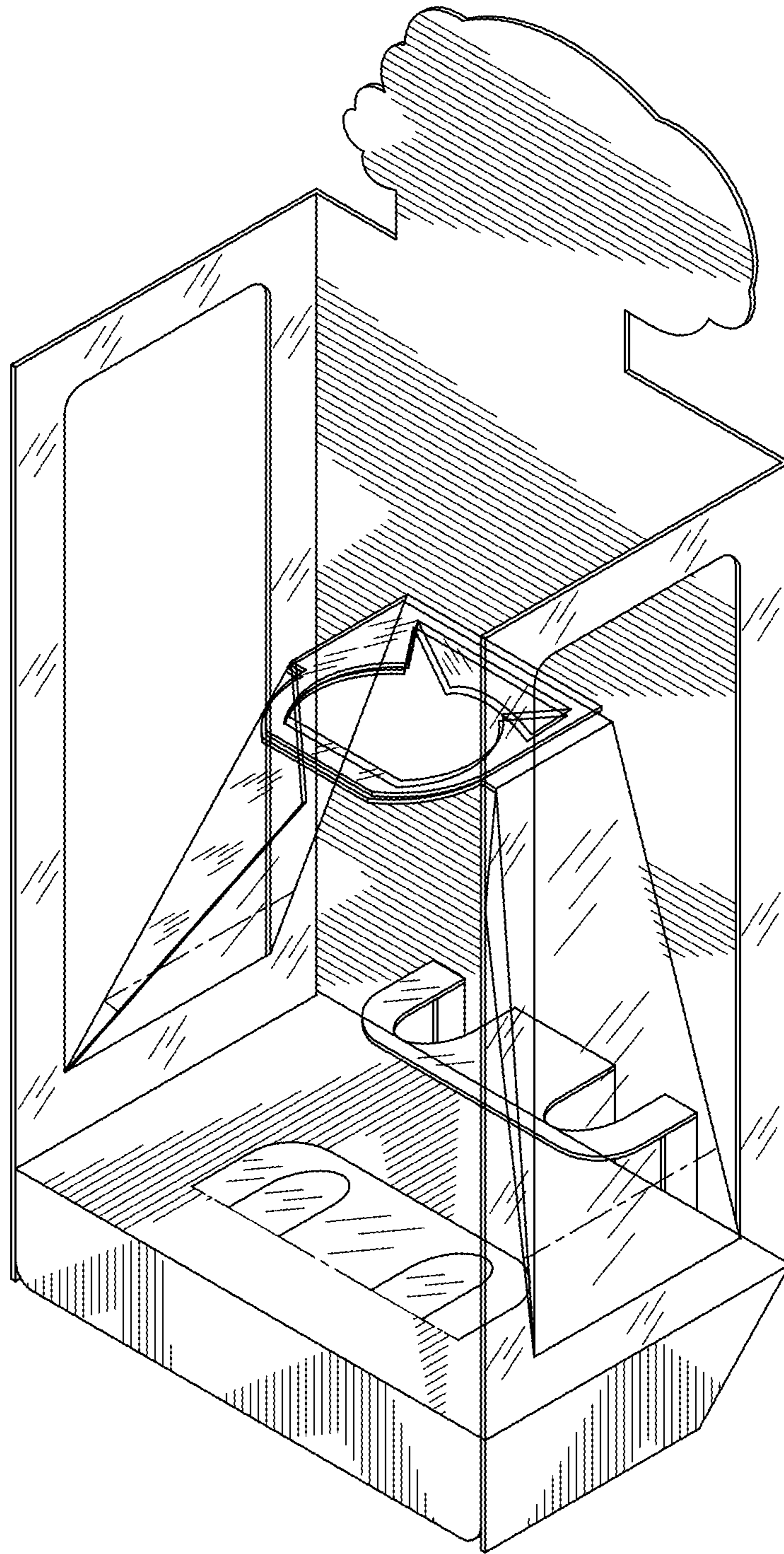

FIG. 9

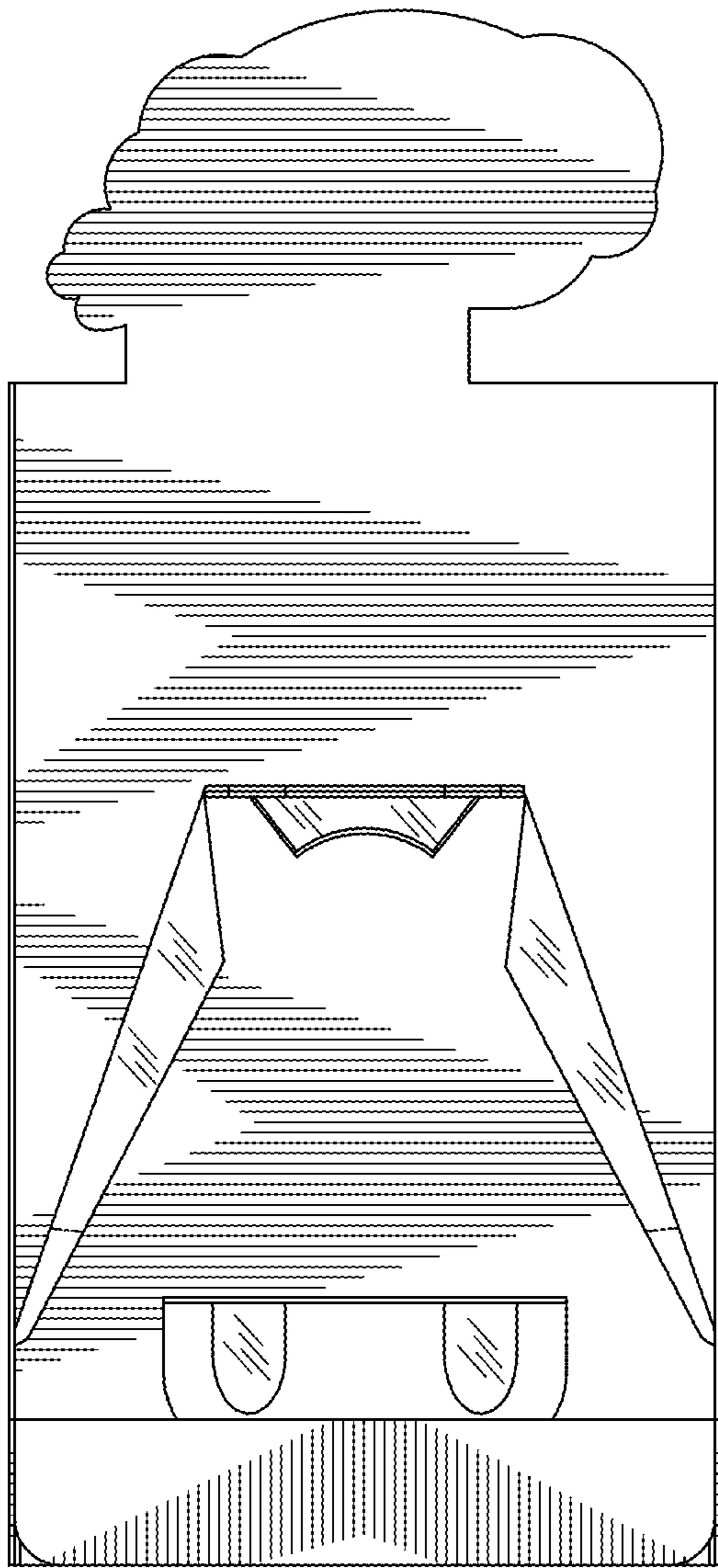

FIG. 10

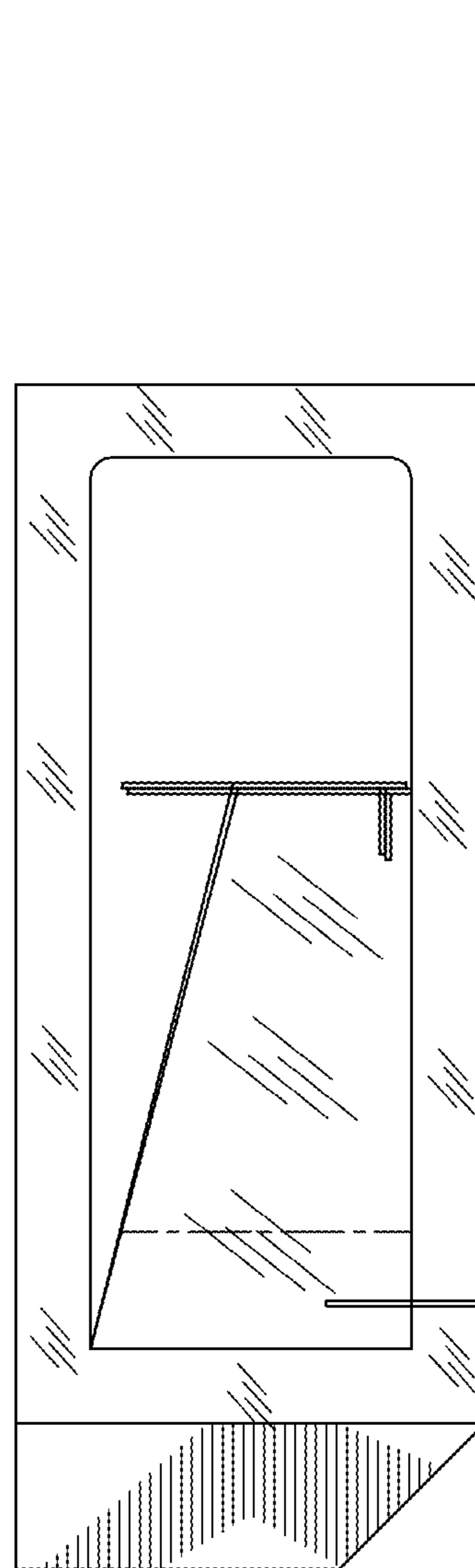

FIG. 11



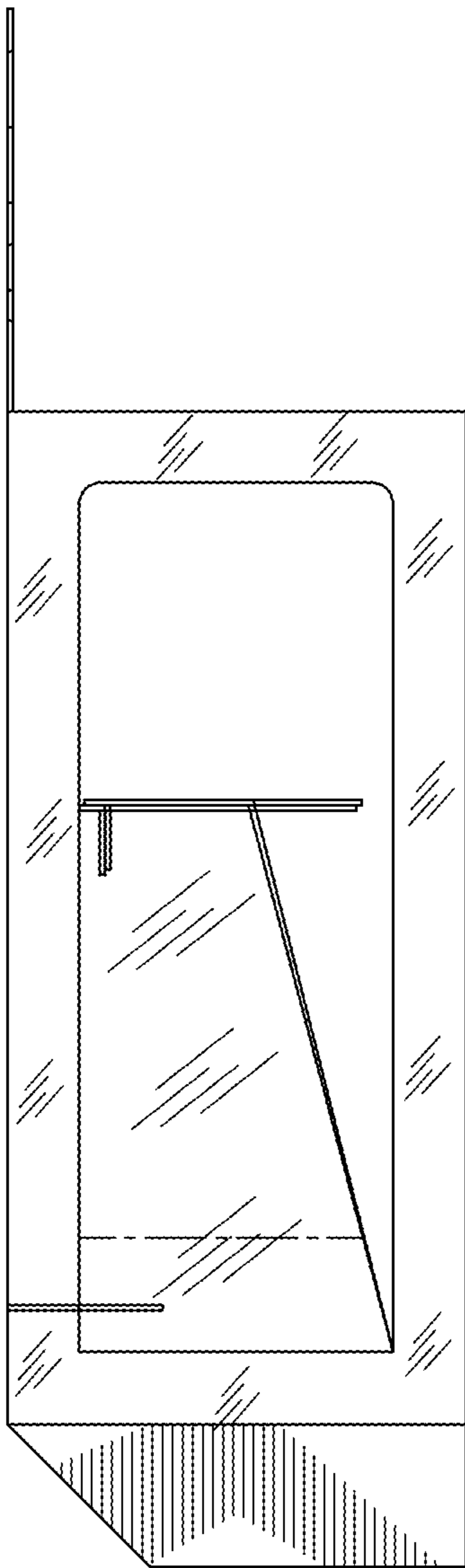
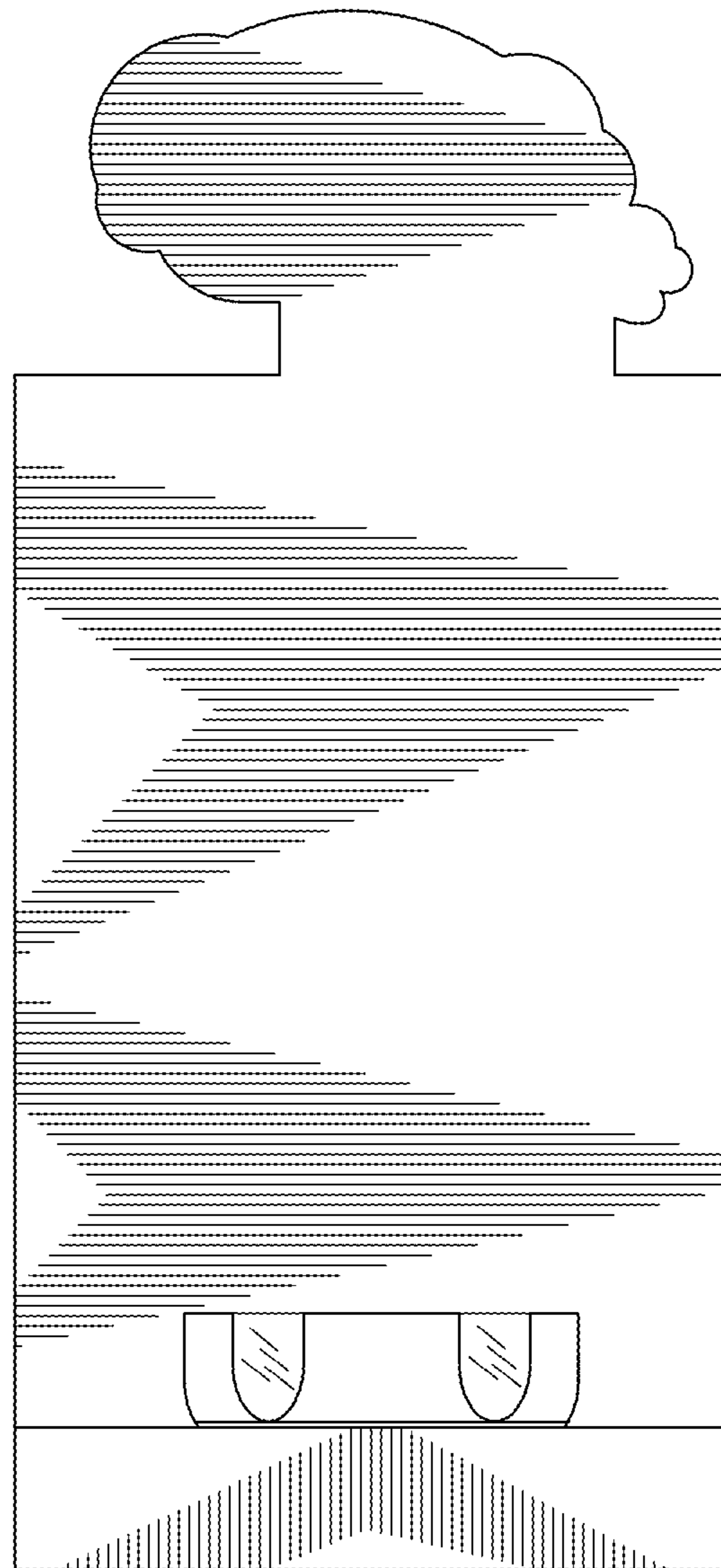
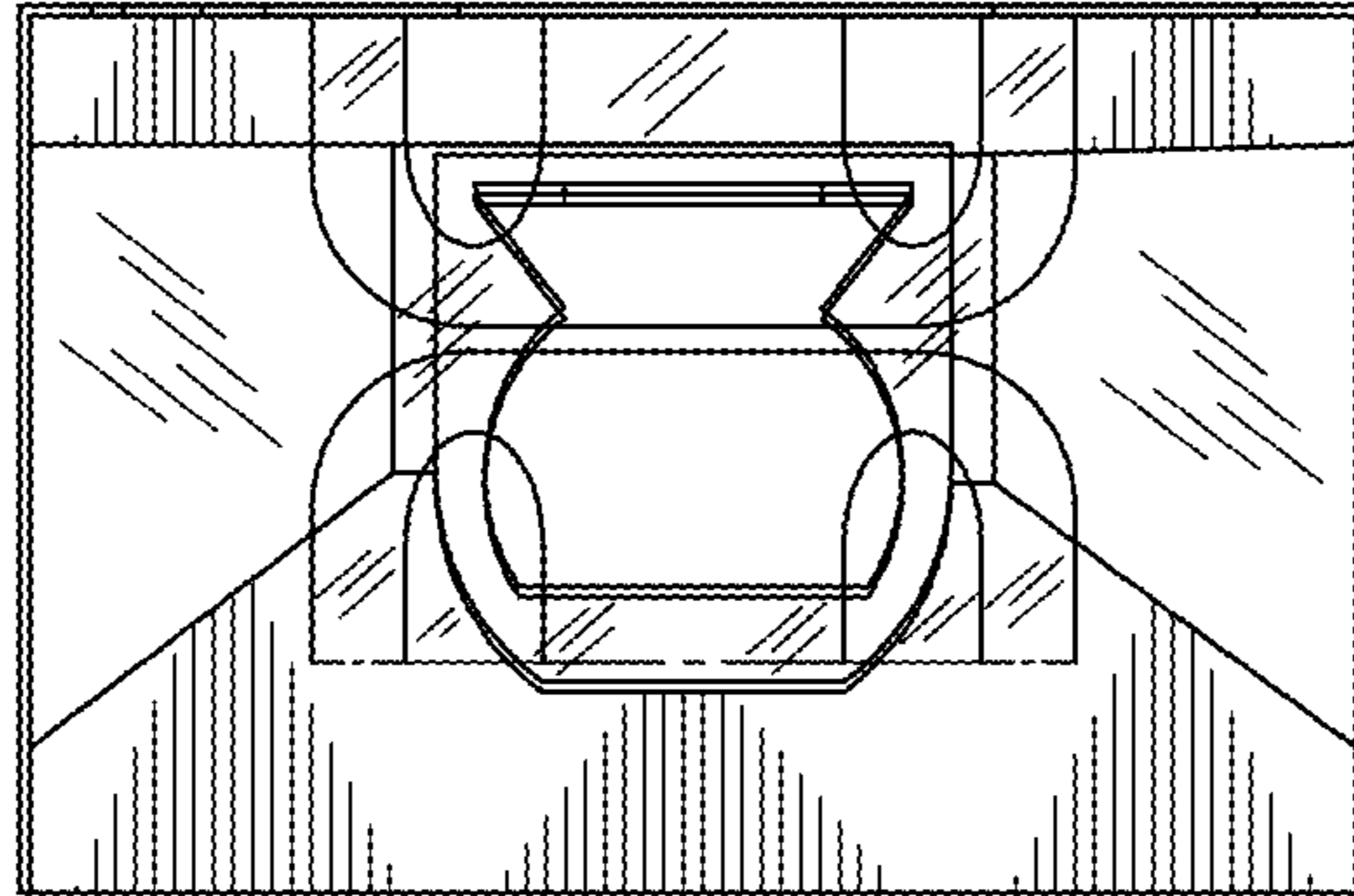

FIG. 12

FIG. 13





*FIG. 14*

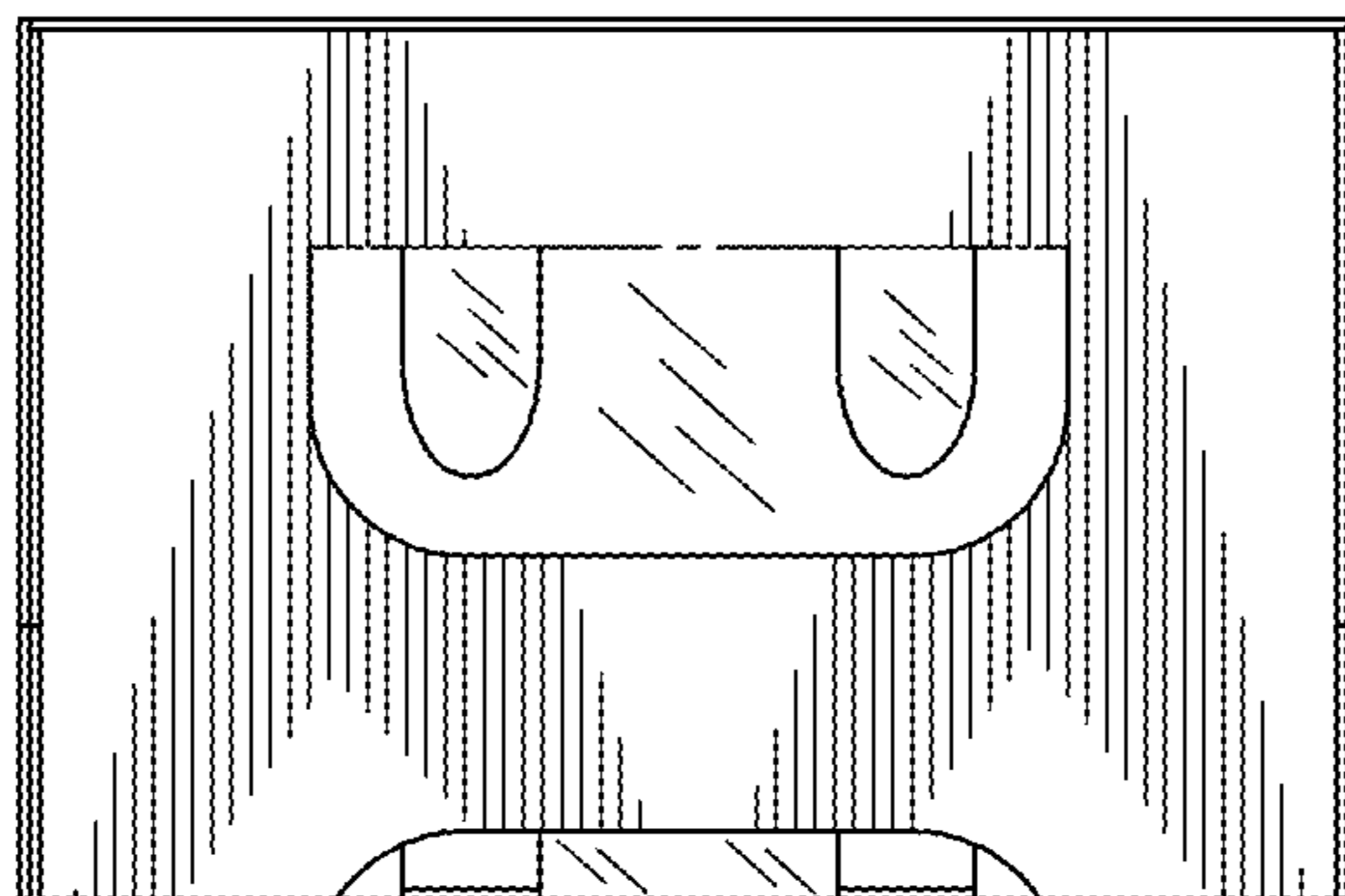

*FIG. 15*