

US00D960567S

(12) **United States Design Patent** (10) **Patent No.:** **US D960,567 S**
Gvasalia (45) **Date of Patent:** **** Aug. 16, 2022**

(54) **BAG**
(71) Applicant: **BALENCIAGA**, Paris (FR)
(72) Inventor: **Demna Gvasalia**, Paris (FR)
(73) Assignee: **Balenciaga**, Paris (FR)
(**) Term: **15 Years**

D834,816 S * 12/2018 Spaziani D3/246
D866,175 S * 11/2019 Vaccarello D3/245
D880,853 S * 4/2020 Vaccarello D3/245

(21) Appl. No.: **29/748,158**
(22) Filed: **Aug. 27, 2020**

FOREIGN PATENT DOCUMENTS

CN 202030556475.5 * 8/2021

(30) **Foreign Application Priority Data**

Feb. 28, 2020 (EM) 007722715-0001

(51) **LOC (13) Cl.** **03-01**

(52) **U.S. Cl.**
USPC **D3/246**

(58) **Field of Classification Search**
USPC D3/232-233, 242-246, 299-303;
D9/702-705
CPC A45C 3/00; A45C 13/103; A45C 3/001;
A45C 3/06
See application file for complete search history.

OTHER PUBLICATIONS

“Balenciaga Winter 20 Show”, first available Mar. 1, 2020, Balenciaga on Youtube.com, site visited Feb. 22, 2022: <https://www.youtube.com/watch?v=9QMugKSXFWQ> (Year: 2020).*

* cited by examiner

Primary Examiner — Jennifer L Watkins
Assistant Examiner — Samantha Lynne Brodowski
(74) *Attorney, Agent, or Firm* — Rothwell, Figg, Ernst & Manbeck, P.C.

(56) **References Cited**

U.S. PATENT DOCUMENTS

1,755,548 A * 4/1930 Lowe A45C 3/00
190/125
D591,505 S * 5/2009 Gonzalez D3/245
D630,845 S * 1/2011 Guichot D3/232
D671,740 S * 12/2012 Guichot D3/243
D671,741 S * 12/2012 Guichot D3/245
D673,771 S * 1/2013 Guichot D3/232
D756,637 S * 5/2016 Philo D3/245
D801,682 S * 11/2017 Guichot D3/246
D814,181 S * 4/2018 Morelli D3/245
D818,265 S * 5/2018 Hawkes D3/232

(57) **CLAIM**
The ornamental design for a bag, as shown and described.

DESCRIPTION

FIG. 1 is a front left perspective view of a bag showing my new design;
FIG. 2 is a front view thereof;
FIG. 3 is a rear view thereof;
FIG. 4 is a right side view thereof;
FIG. 5 is a left side view thereof;
FIG. 6 is a top view thereof;
FIG. 7 is a bottom view thereof; and,
FIG. 8 is a top view thereof, showing the shoulder strap in an alternate position.
The portions of the bag shown in even dash broken lines represent thread stitching and do not form part of the claimed design. The portions of bag shown in long dash-dot-long dash broken lines form no part of the claimed design.

1 Claim, 8 Drawing Sheets

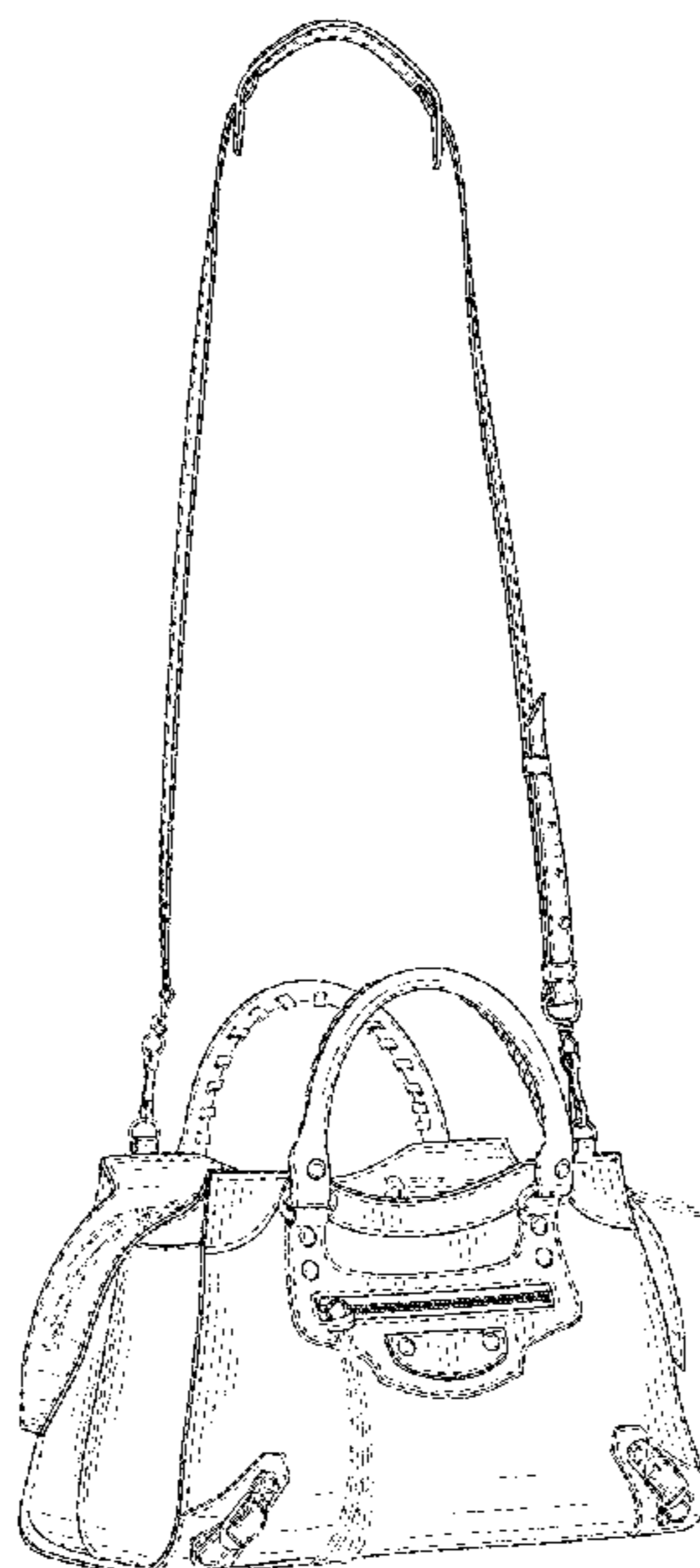

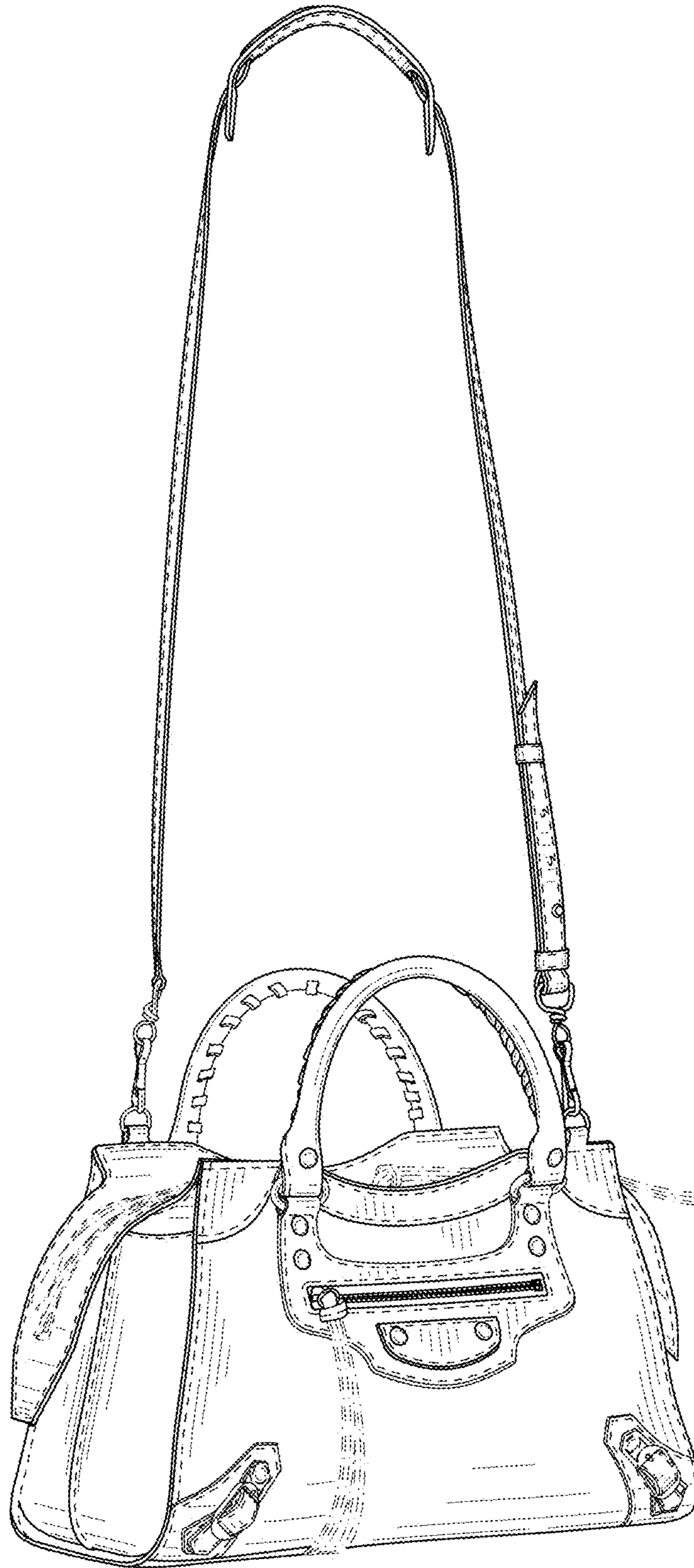

FIG. 1

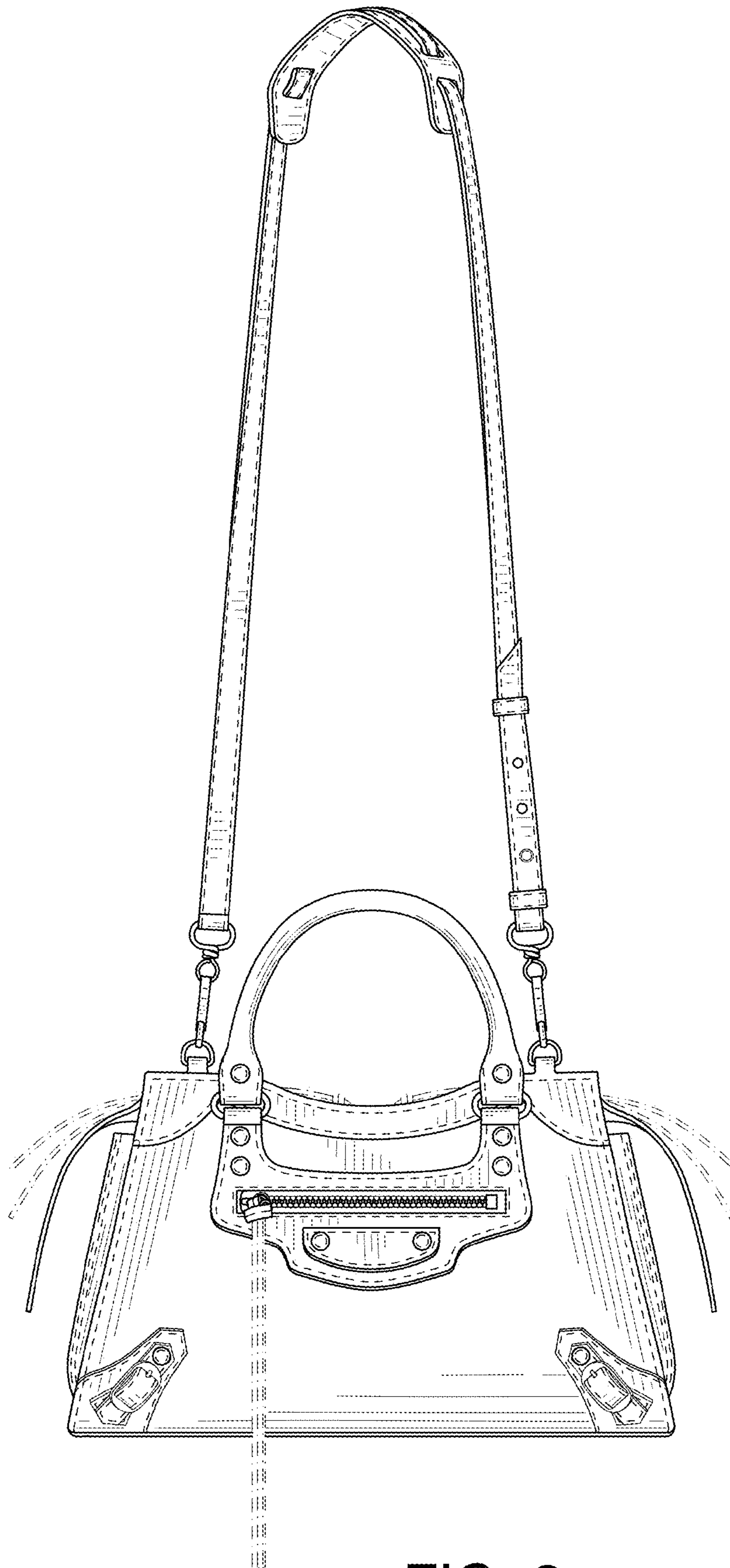

FIG. 2

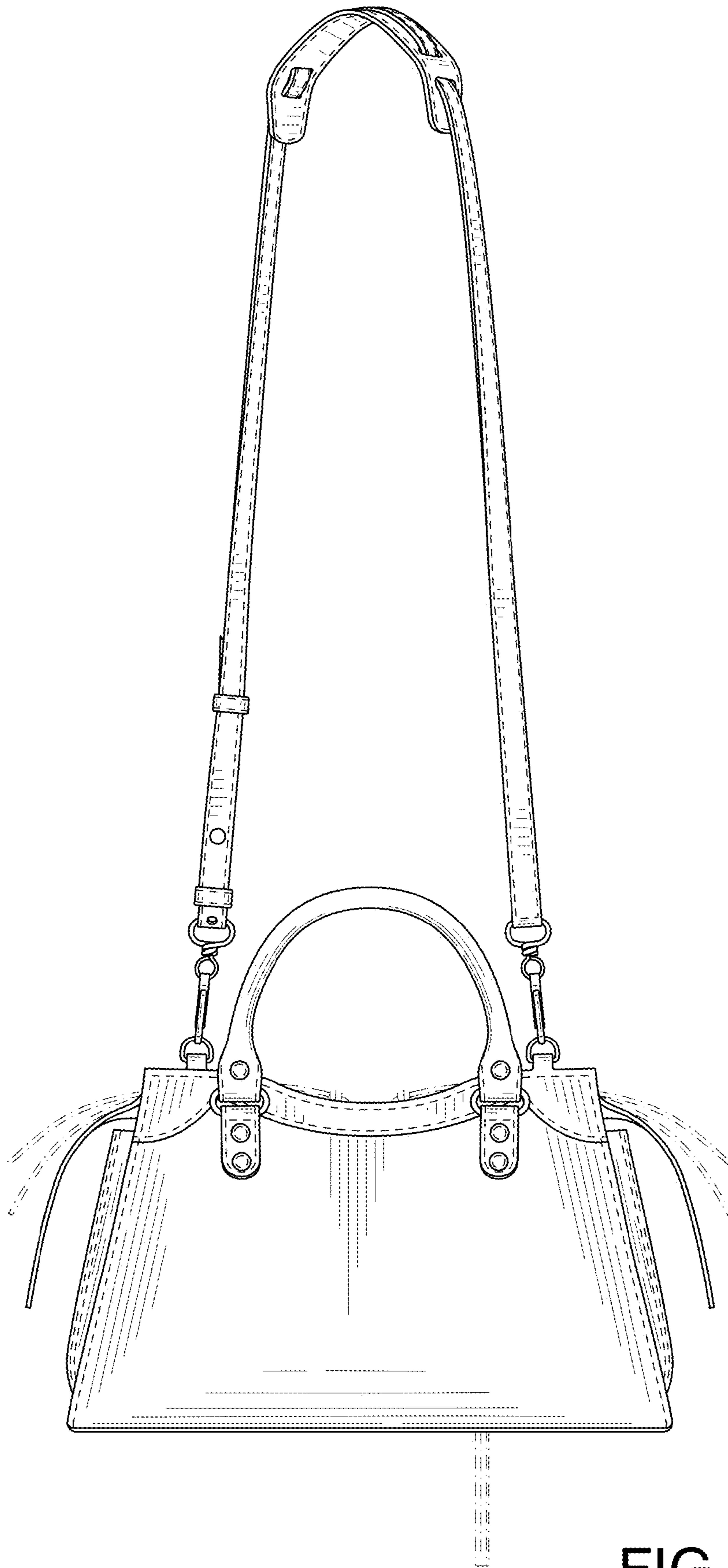

FIG. 3

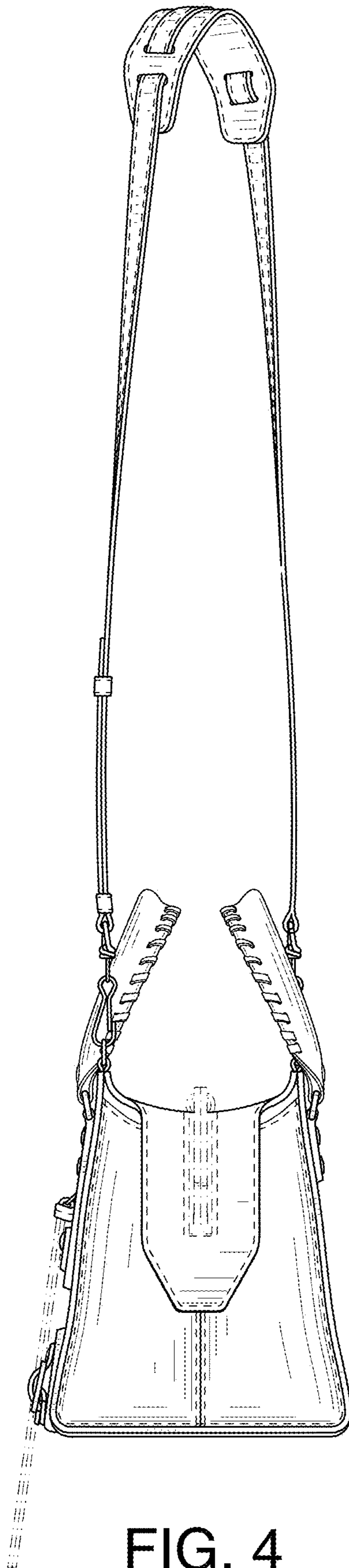

FIG. 4

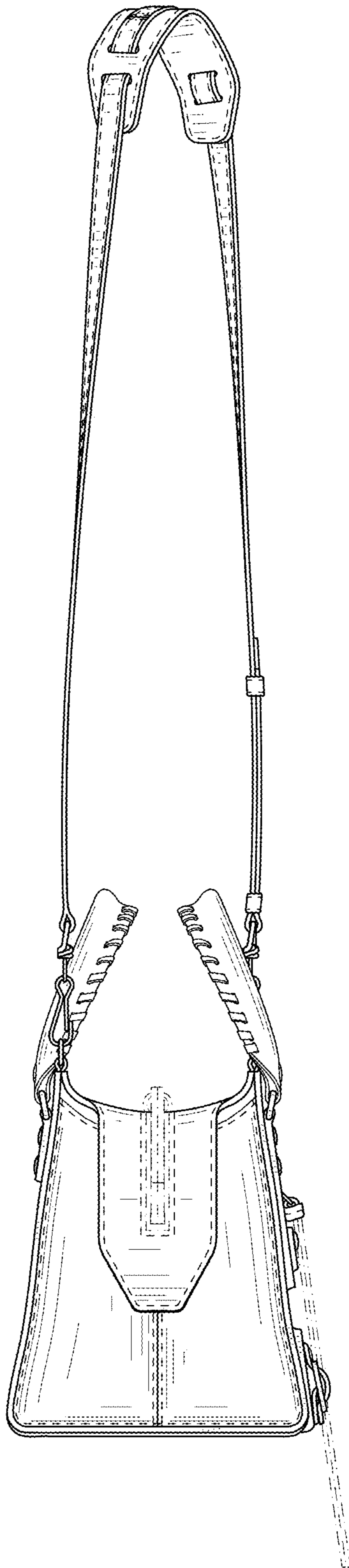

FIG. 5

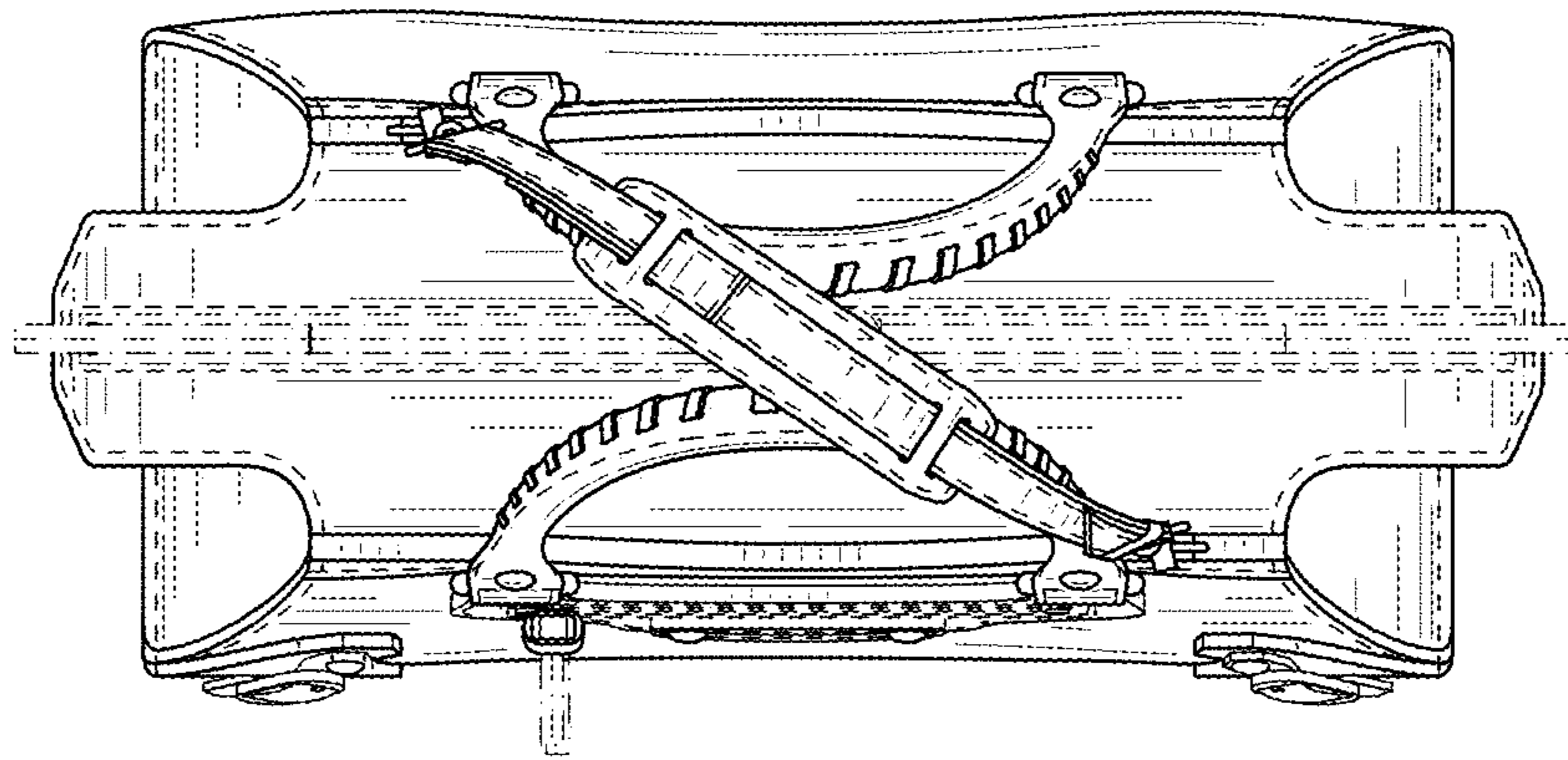

FIG. 6

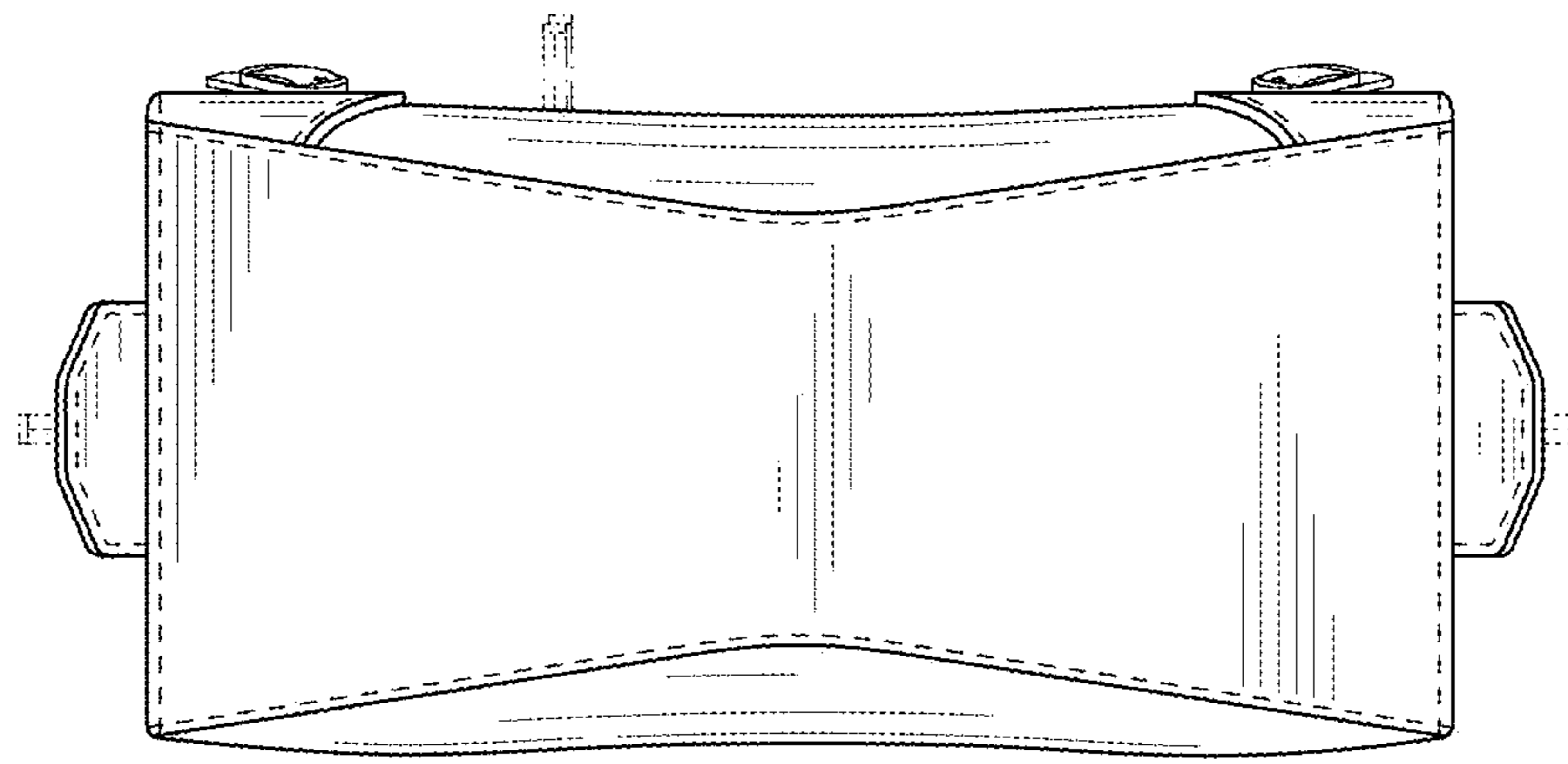

FIG. 7

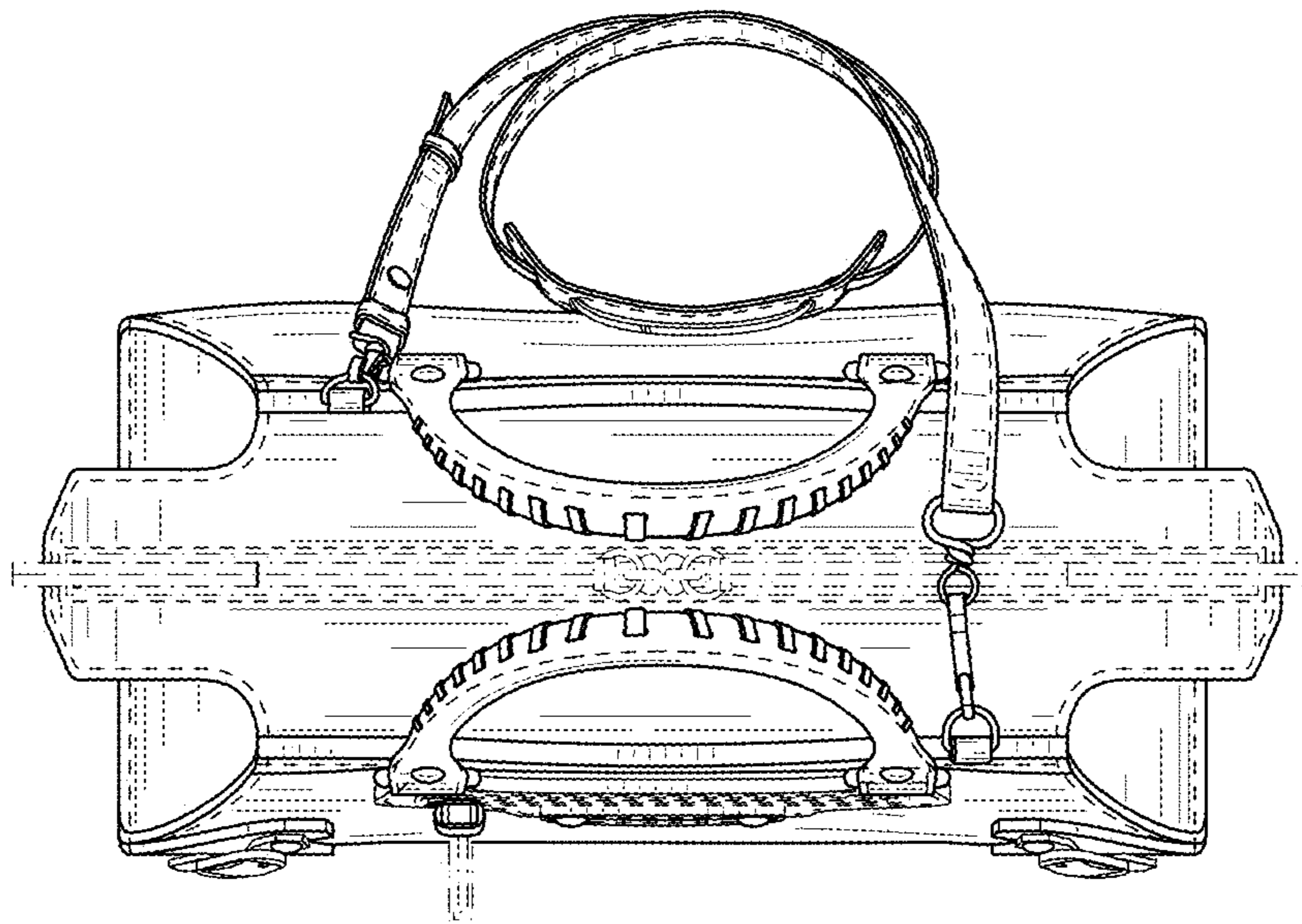

FIG. 8