

US00D960530S

(12) **United States Design Patent** (10) **Patent No.:** **US D960,530 S**  
**Gramajo** (45) **Date of Patent:** **\*\* Aug. 16, 2022**

(54) **GARMENT WITH POCKET**  
 (71) Applicant: **Rosa Gramajo**, Riverside, CA (US)  
 (72) Inventor: **Rosa Gramajo**, Riverside, CA (US)  
 (\*\*) Term: **15 Years**  
 (21) Appl. No.: **29/701,797**  
 (22) Filed: **Aug. 14, 2019**  
 (51) **LOC (13) Cl.** ..... **02-02**  
 (52) **U.S. Cl.**  
 USPC ..... **D2/857**  
 (58) **Field of Classification Search**  
 USPC ..... D2/857, 836, 863-864, 791, 820, 716,  
 D2/738, 712  
 CPC ..... A41D 1/02; A41D 27/20; A41D 27/201;  
 A41D 27/202  
 See application file for complete search history.

(56) **References Cited**  
 U.S. PATENT DOCUMENTS  
 2,565,023 A \* 8/1951 Hepp ..... A41D 27/20  
 2/247  
 D474,892 S \* 5/2003 Vazquez ..... D2/857  
 D732,799 S \* 6/2015 Smith ..... D2/831  
 D851,858 S \* 6/2019 Hunter ..... D2/706  
 D897,070 S \* 9/2020 Rapp ..... D2/857  
 D927,138 S \* 8/2021 Gramajo ..... D2/857

2015/0359269 A1\* 12/2015 Rapp ..... A41D 1/02  
 2/93  
 2018/0206567 A1\* 7/2018 Diakonov ..... A41D 13/0012  
 2018/0242667 A1\* 8/2018 Horton ..... A41D 1/18  
 2019/0373970 A1\* 12/2019 Bolker ..... A41D 1/089

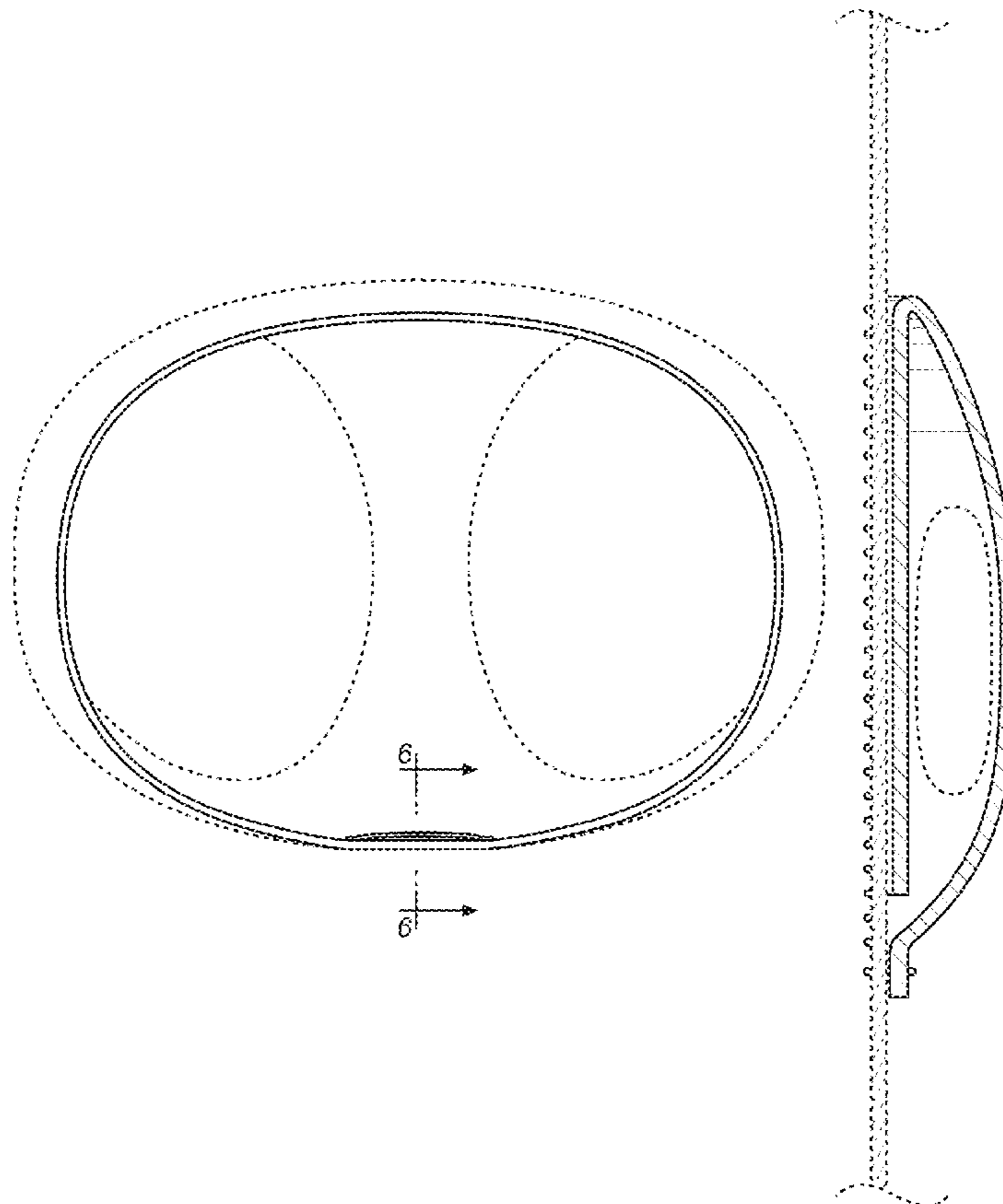
\* cited by examiner

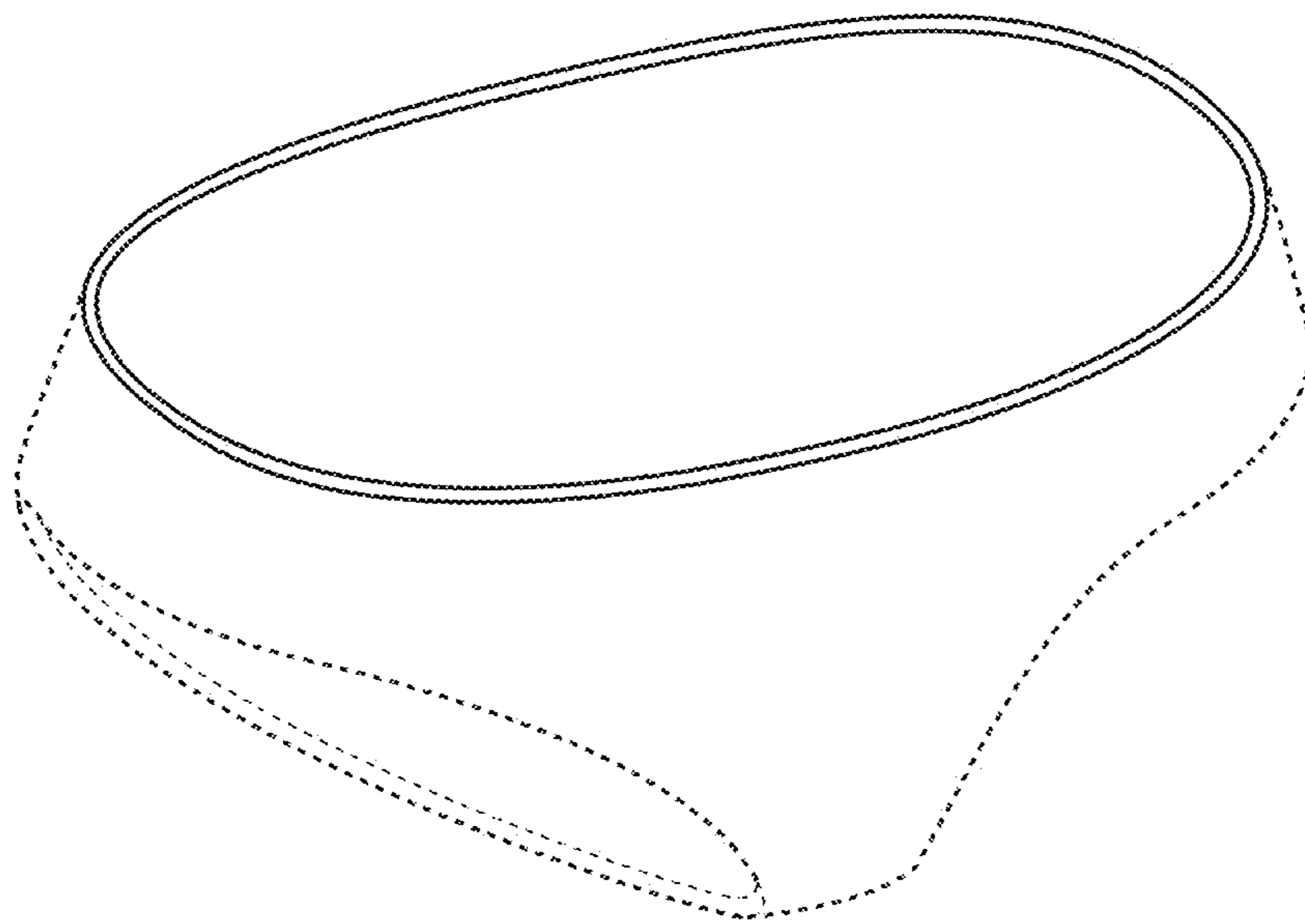
*Primary Examiner* — Kevin K Rudzinski  
*Assistant Examiner* — J. Thorn, Sr.  
 (74) *Attorney, Agent, or Firm* — Innovent Law, P.C.;  
 Karima Gulick

(57) **CLAIM**  
 The ornamental design for a garment with pocket, as shown  
 and described.

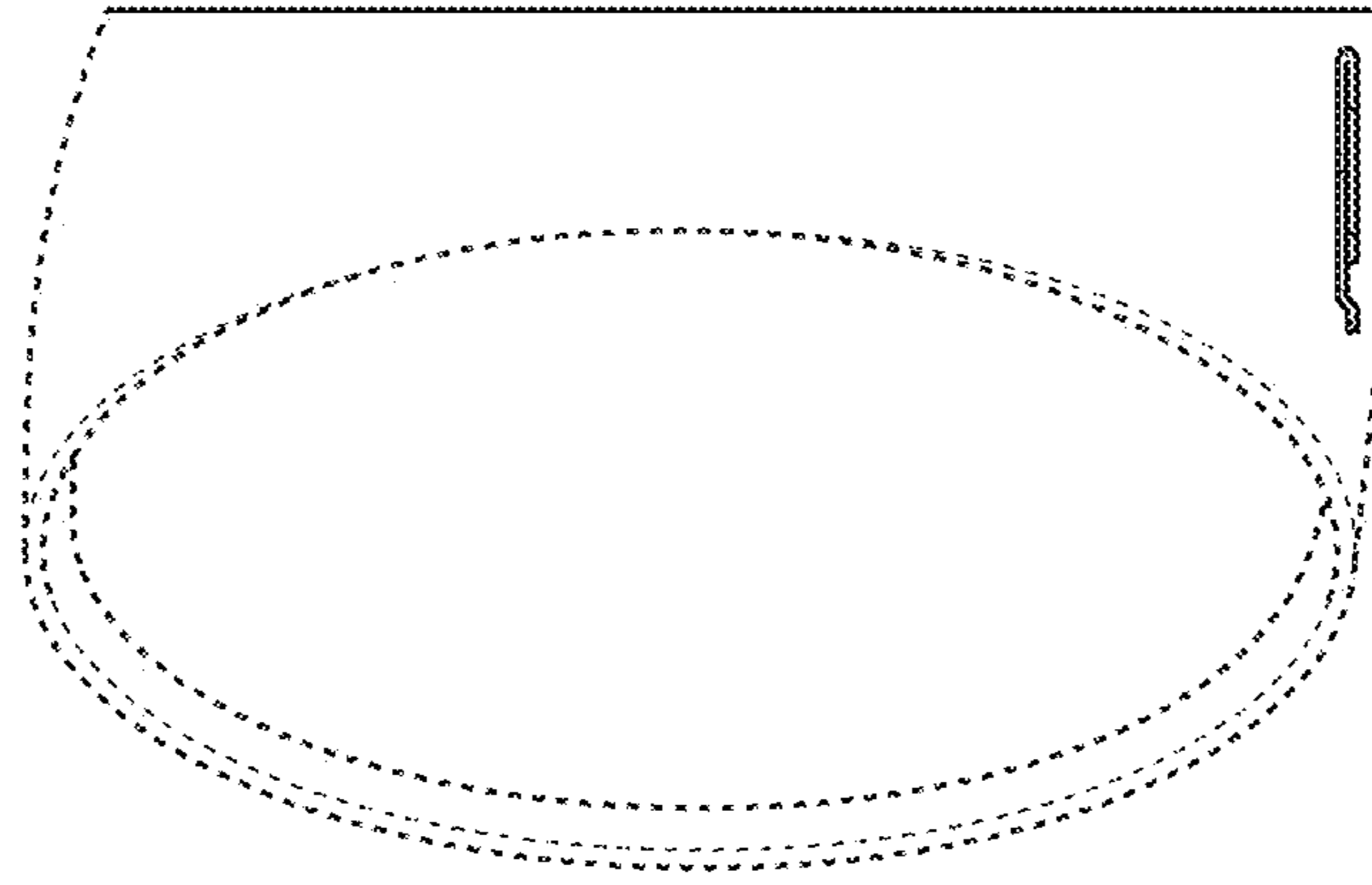
**DESCRIPTION**  
 FIG. 1 is a perspective front view of a garment with pocket  
 in environmental conditions showing my new design;  
 FIG. 2 is a right side view thereof;  
 FIG. 3 is a left side view thereof;  
 FIG. 4 is a top plan view thereof;  
 FIG. 5 is a bottom plan view thereof;  
 FIG. 6 is a cross-sectional view thereof, taken along line 6-6  
 in FIG. 4; and,  
 FIG. 7 is an enlarged view thereof, taken from FIG. 6.  
 The broken lines of the figures showing additional portions  
 of the garment are included for the purpose of illustrating  
 environmental structure and form no part of the claimed  
 design.

**1 Claim, 5 Drawing Sheets**

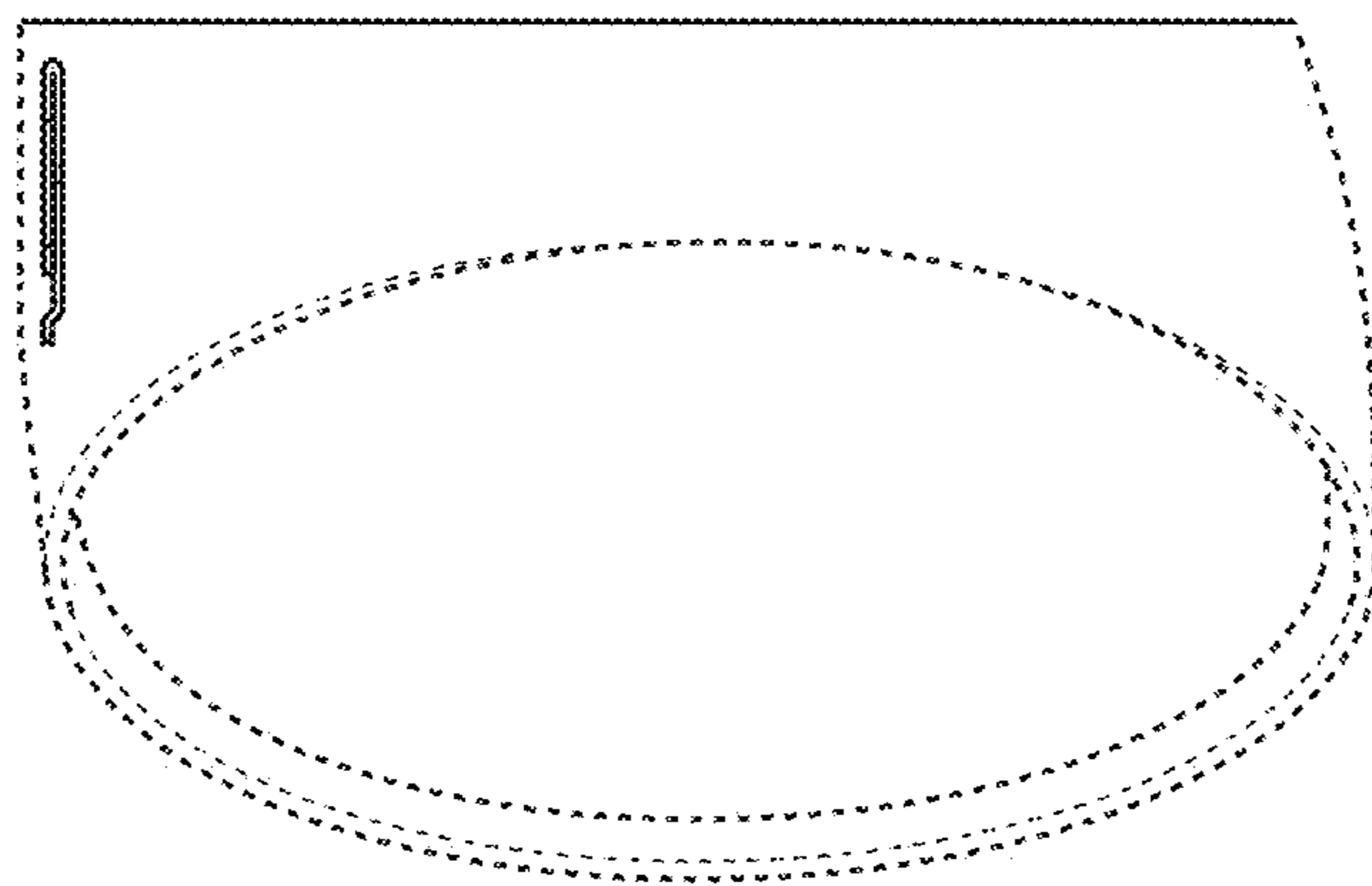




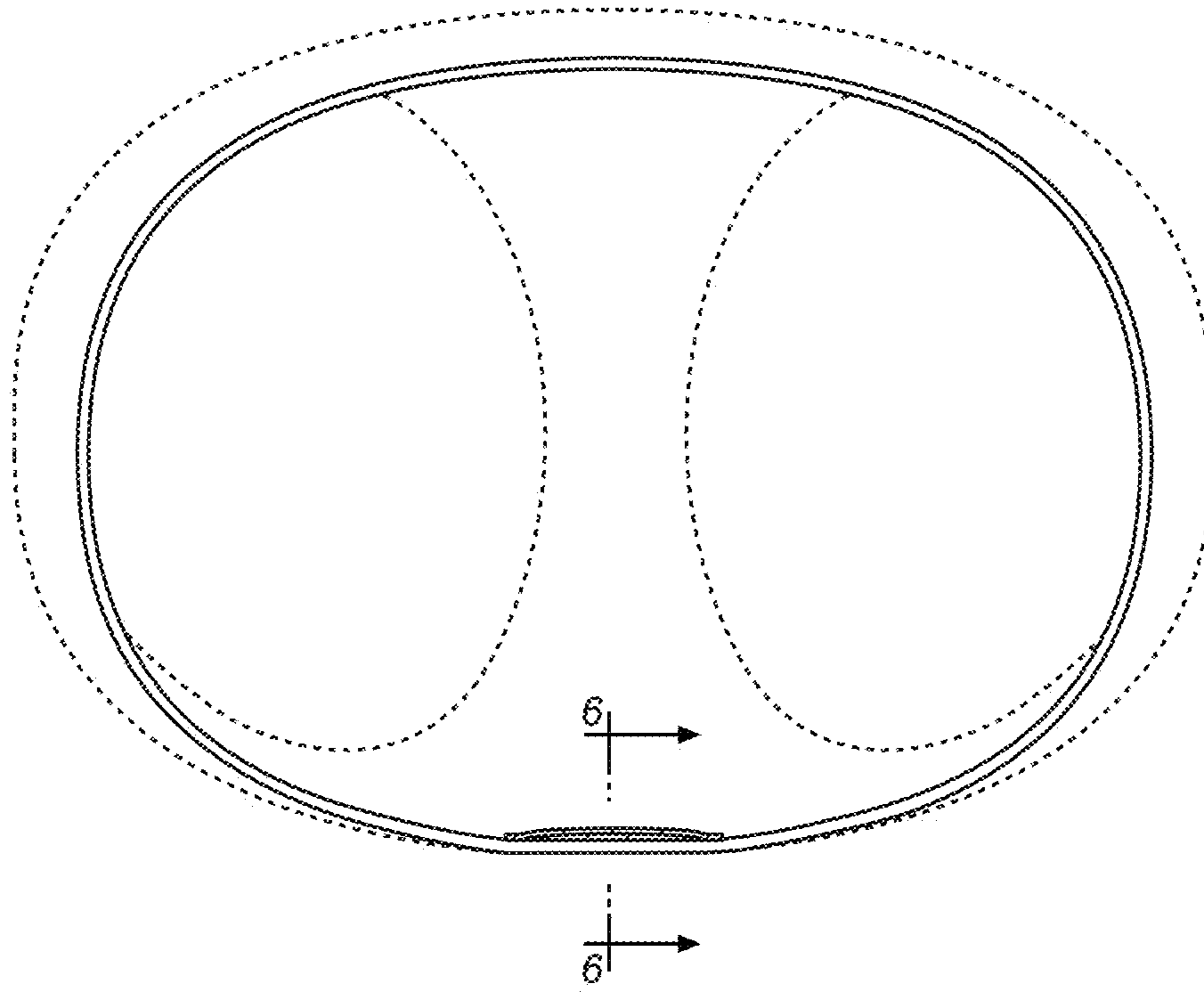
**FIG. 1**



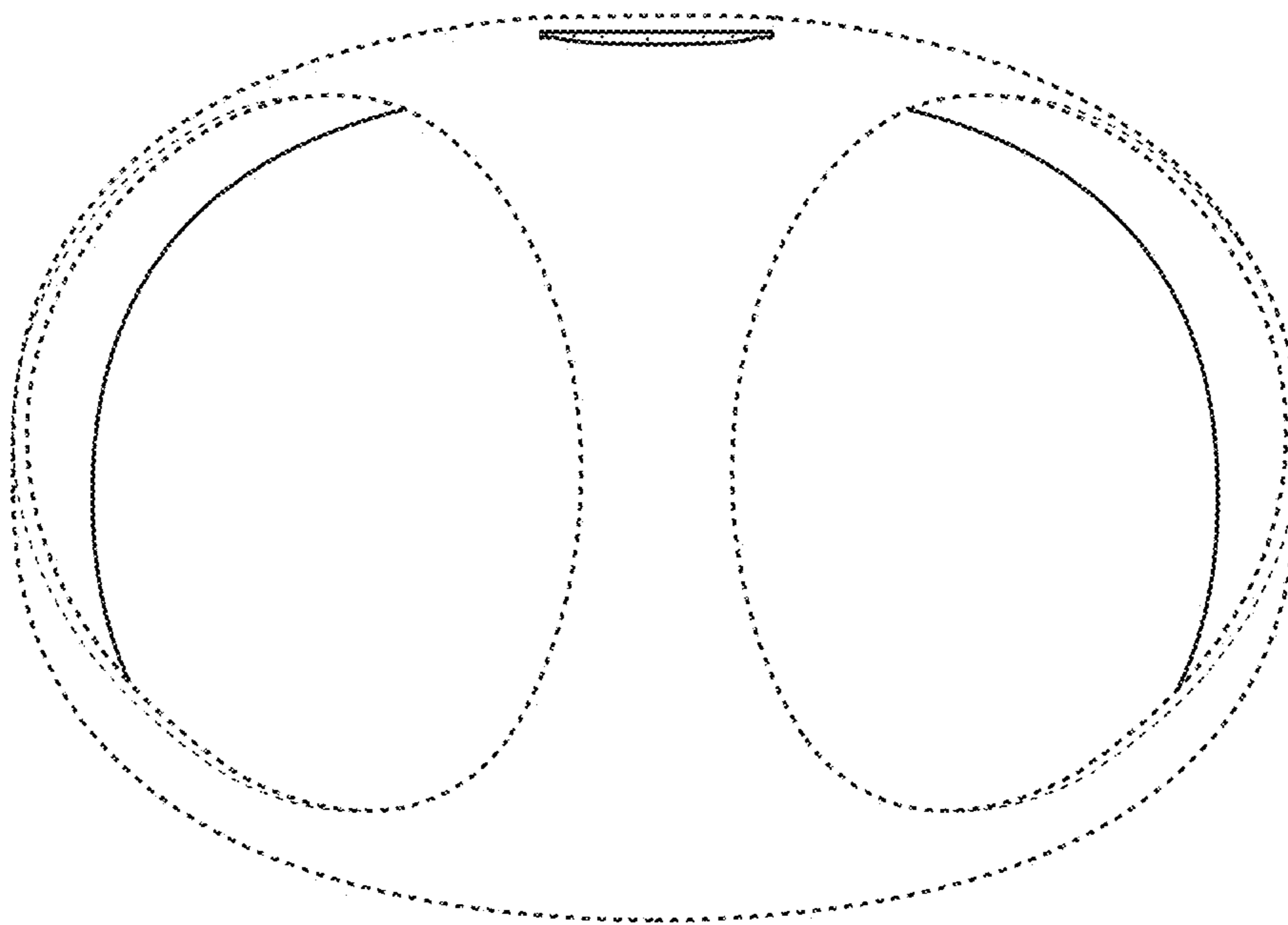
**FIG. 2**



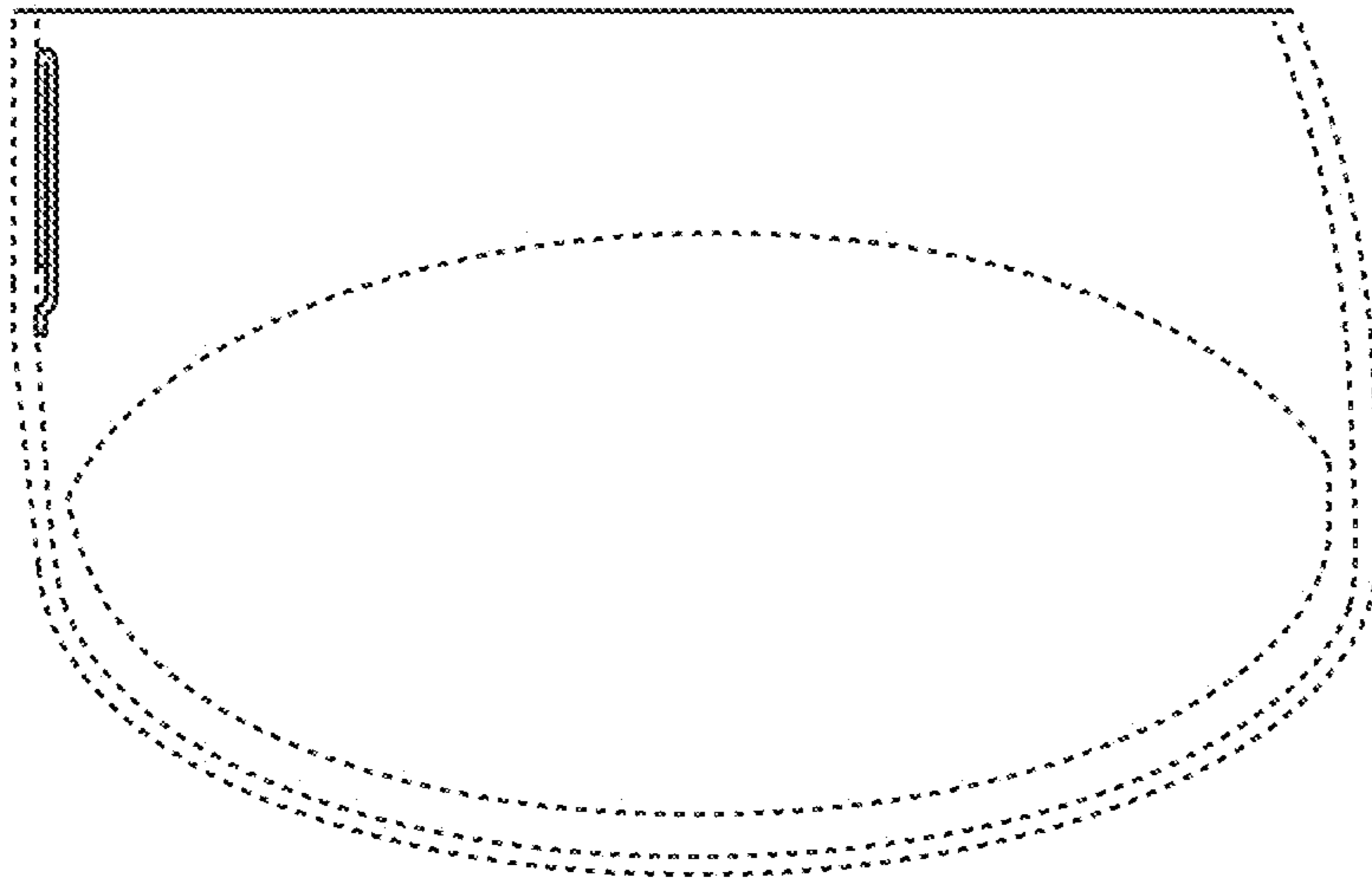
**FIG. 3**



**FIG. 4**



**FIG. 5**



**FIG. 6**

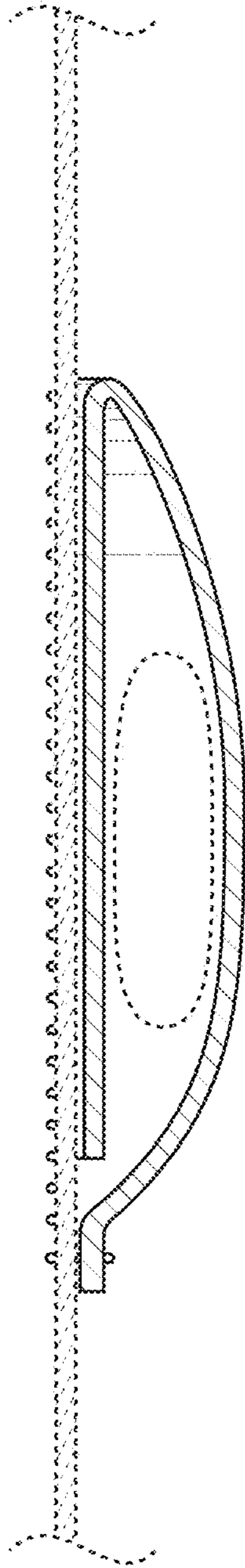


FIG. 7