



US00D960489S

(12) **United States Design Patent**  
**Cai**

(10) **Patent No.:** **US D960,489 S**

(45) **Date of Patent:** **\*\* Aug. 16, 2022**

(54) **BOTTOM WEAR**

(71) Applicant: **THE LUXTRADA COMPANY,**  
Walnut, CA (US)

(72) Inventor: **Jian Cai,** Walnut, CA (US)

(\*\*) Term: **15 Years**

(21) Appl. No.: **29/692,012**

(22) Filed: **May 21, 2019**

(51) **LOC (13) Cl.** ..... **02-01**

(52) **U.S. Cl.**

USPC ..... **D2/701**

(58) **Field of Classification Search**

USPC ..... D2/701, 705, 712, 722, 738, 639, 999,  
D2/860; D24/155

CPC ..... A41D 27/26; A41D 1/06  
See application file for complete search history.

(56) **References Cited**

**U.S. PATENT DOCUMENTS**

D270,489 S *	9/1983	Camus	.....	D2/701
D340,982 S *	11/1993	Terino	.....	D24/155
5,513,393 A *	5/1996	Ferreira	.....	A41C 1/003 2/267
D402,789 S *	12/1998	Detrie	.....	D2/860
D405,588 S *	2/1999	Wall	.....	D2/860
D477,078 S *	7/2003	Gutstein	.....	D24/155
D656,300 S *	3/2012	Purcell	.....	D2/742
2007/0118954 A1 *	5/2007	Lee	.....	A41C 1/003 2/69
2010/0064409 A1 *	3/2010	Buckley	.....	A41D 27/26 2/67

**OTHER PUBLICATIONS**

Foam Buns, posted early as 2017 [online], (retrieved Jul. 8, 2021).  
Retrieved from the internet, <https://www.amazon.ca/Foam-Buns->

Shown-One-Size/dp/B000HL3Y3C/ref=pd\_day0\_1/147-0292650-2966656?pd\_rd\_w=AELJa&pf\_rd\_p=a0f07c06-3%E2%80%A6 (Year: 2017).\*

(Continued)

*Primary Examiner* — Kevin K Rudzinski

*Assistant Examiner* — J. Thorn, Sr.

(74) *Attorney, Agent, or Firm* — Tommy S F Wang;  
Wang IP Law Group, P.C.

(57) **CLAIM**

The ornamental design for a bottom wear, as shown and described.

**DESCRIPTION**

FIG. 1 is a perspective view of a bottom wear pad of a bottom wear showing my new design;  
 FIG. 2 is a front view thereof;  
 FIG. 3 is a rear view thereof;  
 FIG. 4 is a left side view thereof;  
 FIG. 5 is a right side view thereof;  
 FIG. 6 is a top view thereof;  
 FIG. 7 is a bottom view thereof;  
 FIG. 8 is a cross-sectional view thereof taken along the line 8-8 of FIG. 2;  
 FIG. 9 is a perspective view of the bottom wear;  
 FIG. 10 is a cross-sectional view thereof taken along the line 10-10 of FIG. 9;  
 FIG. 11 is a cross-sectional view thereof taken along the line 11-11 of FIG. 9;  
 FIG. 12 is another perspective view of the bottom wear;  
 FIG. 13 is a cross-sectional view thereof taken along the line 13-13 of FIG. 12; and,  
 FIG. 14 is a cross-sectional view thereof taken along the line 14-14 of FIG. 12.  
 The broken lines in the drawings are for the purpose of illustratine portions of the bottom wear that form no part of the claimed design. The dot-dash broken lines in FIG. 9 represent unclaimed boundary lines and form no part of the claimed design.

**1 Claim, 9 Drawing Sheets**

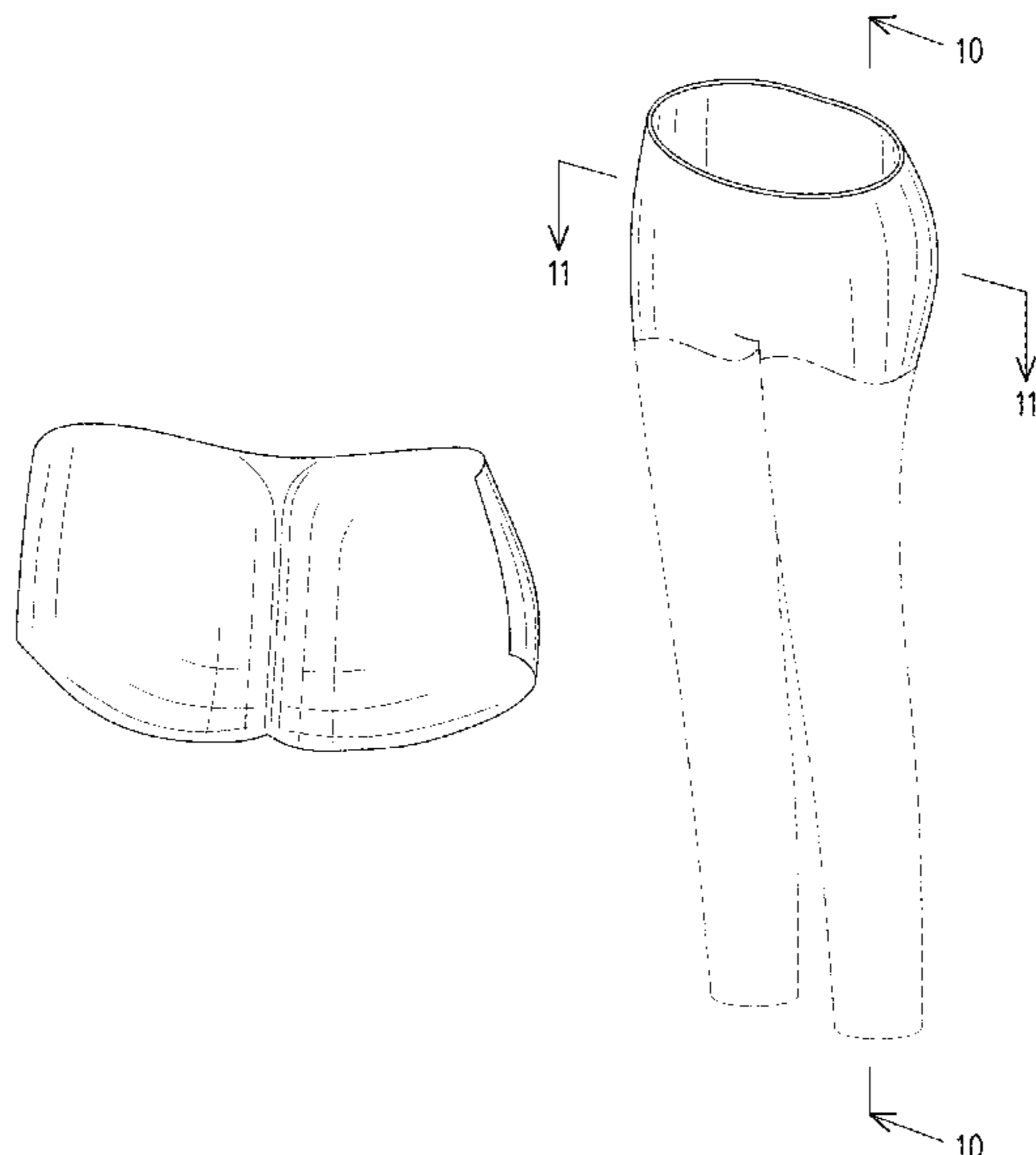

(56)

**References Cited**

OTHER PUBLICATIONS

ToBeInStyle Men's Instant Butt Booster Enhancing Padded Lifting Briefs Boxers, posted Jul. 20, 2016 [online], (retrieved Jul. 8, 2021). Retrieved from the internet, [https://www.amazon.com/ToBeInStyle-Mens-Butt-Booster-Black/dp/B00VTFRK4/ref=pd\\_lpo\\_193\\_t\\_0/139-5045076-0138369?\\_encoding=UTF8&pd\\_%E2%80%A6](https://www.amazon.com/ToBeInStyle-Mens-Butt-Booster-Black/dp/B00VTFRK4/ref=pd_lpo_193_t_0/139-5045076-0138369?_encoding=UTF8&pd_%E2%80%A6) (Year: 2016).\*

\* cited by examiner

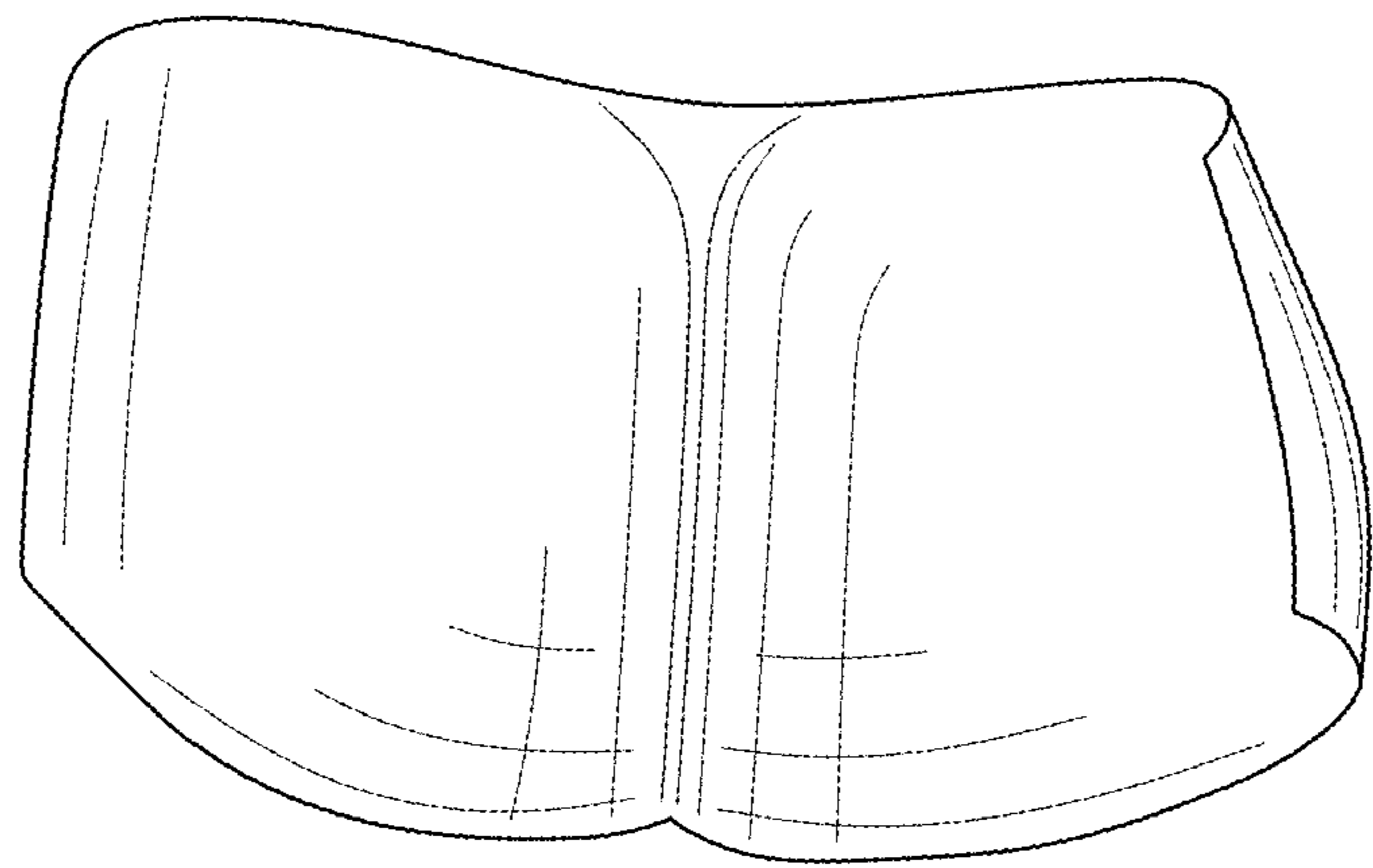

FIG. 1

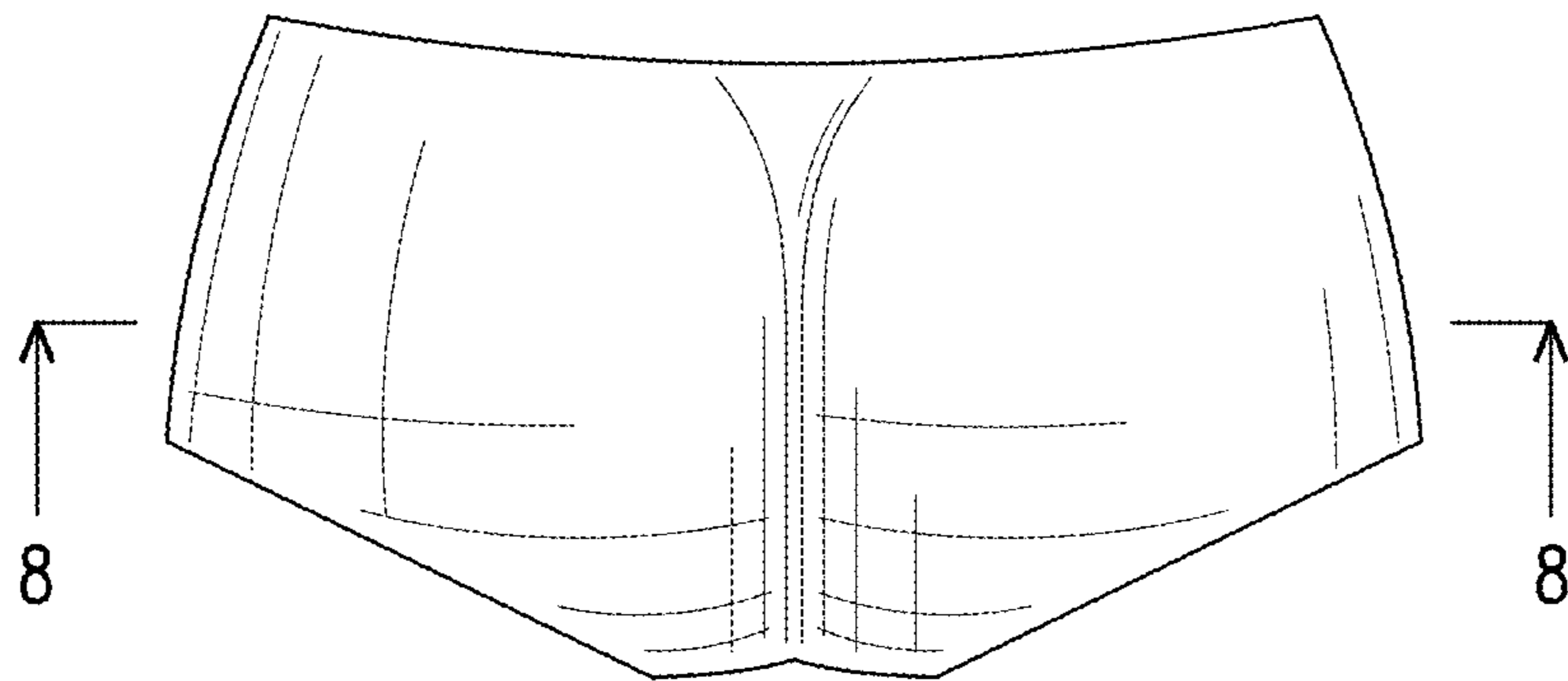

FIG. 2

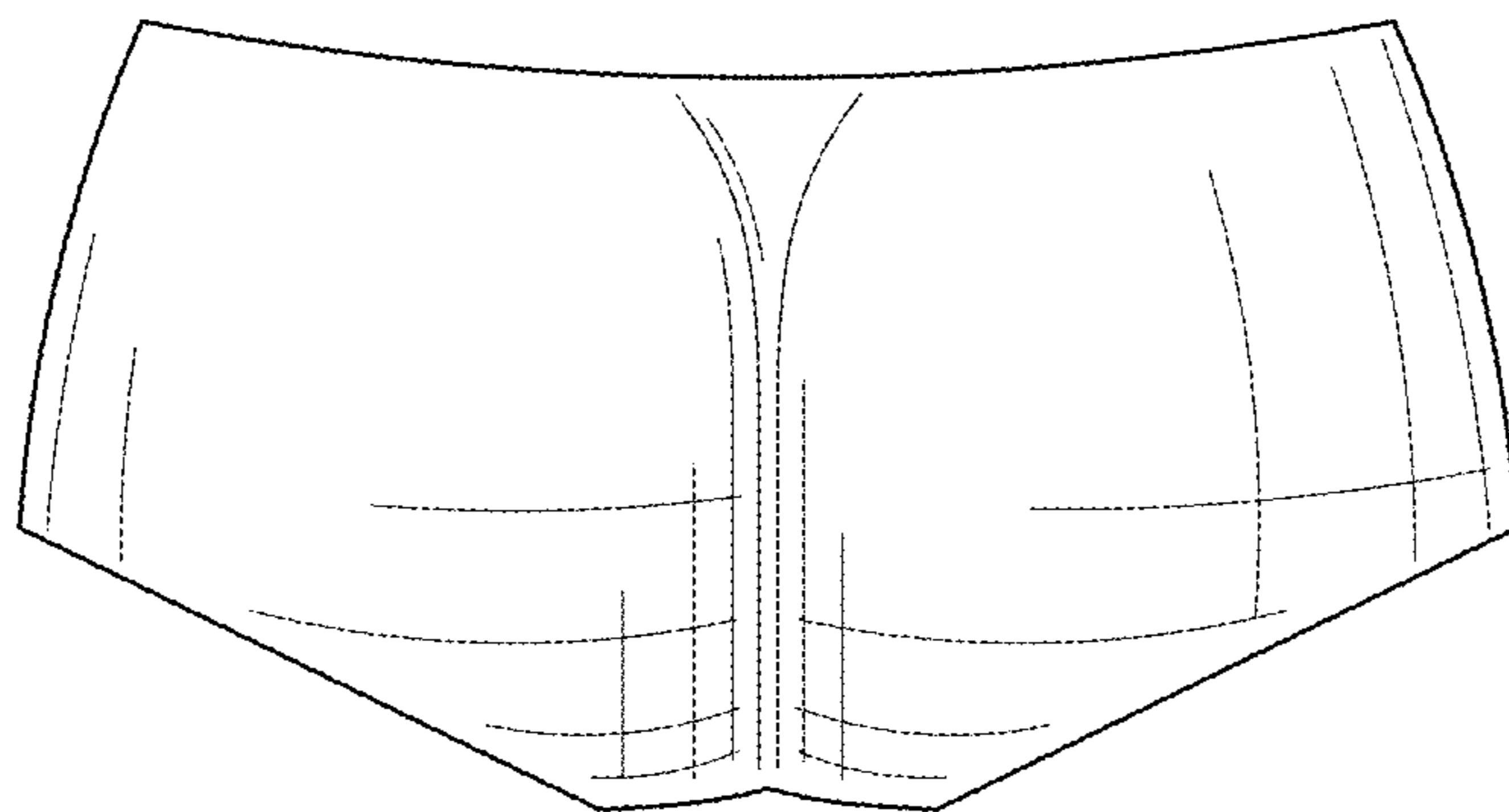

FIG. 3

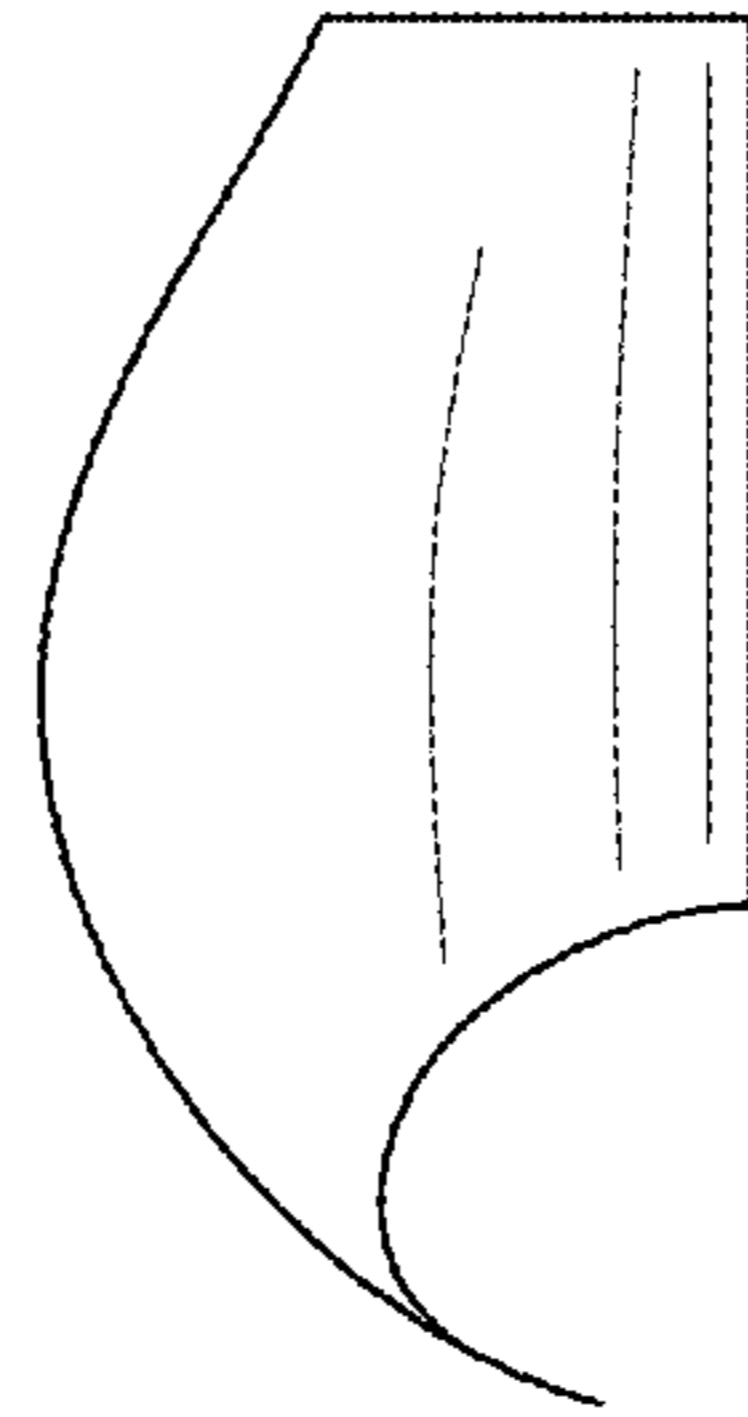

FIG. 4

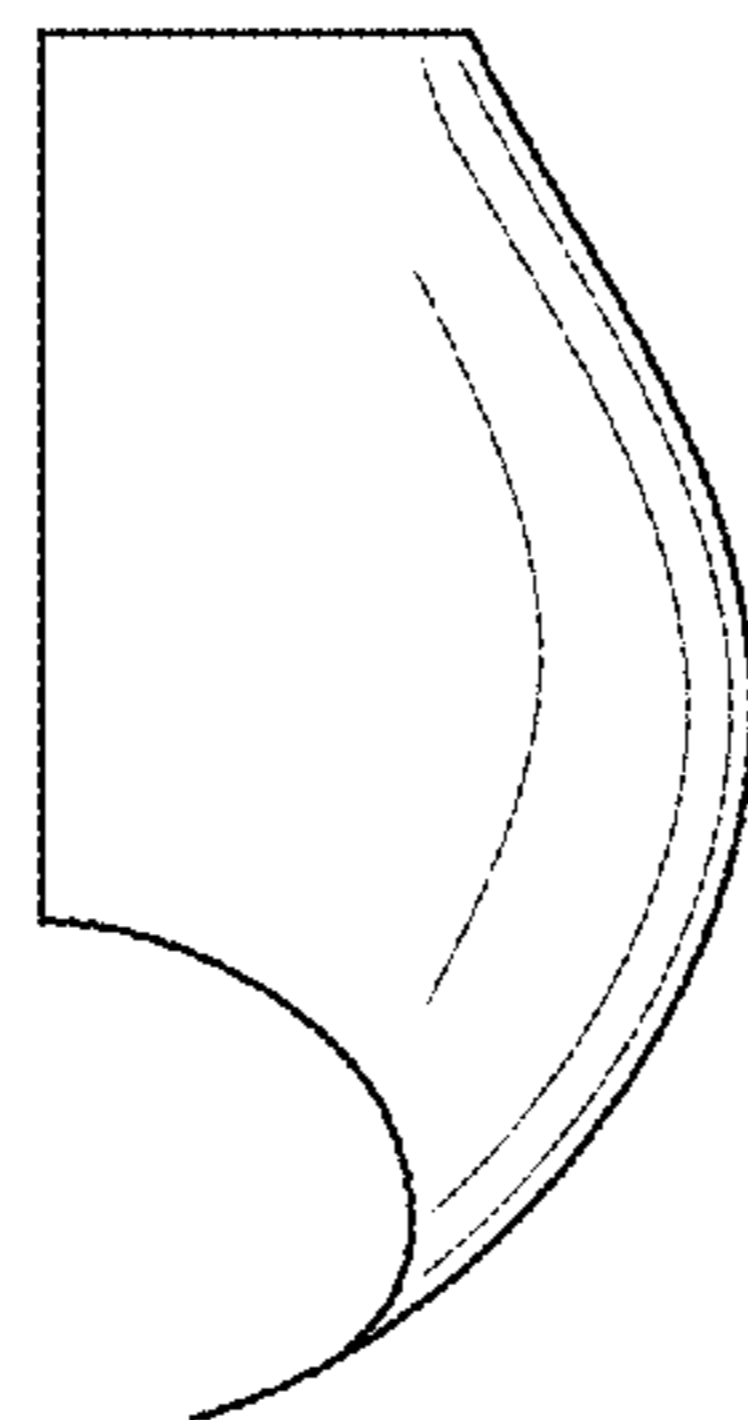

FIG. 5

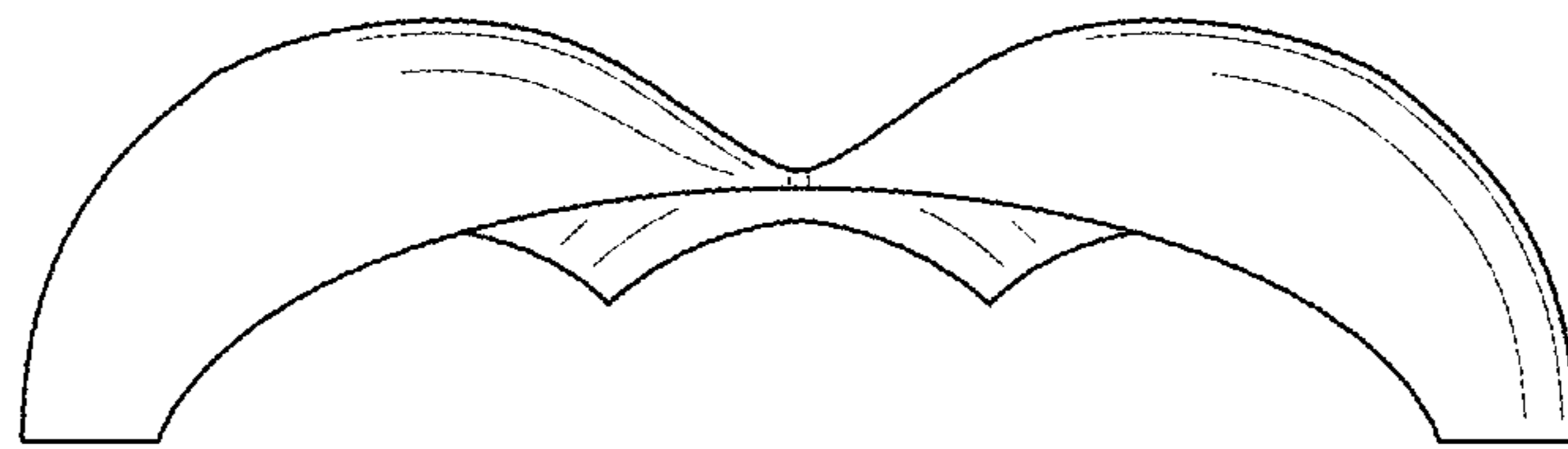

FIG. 6

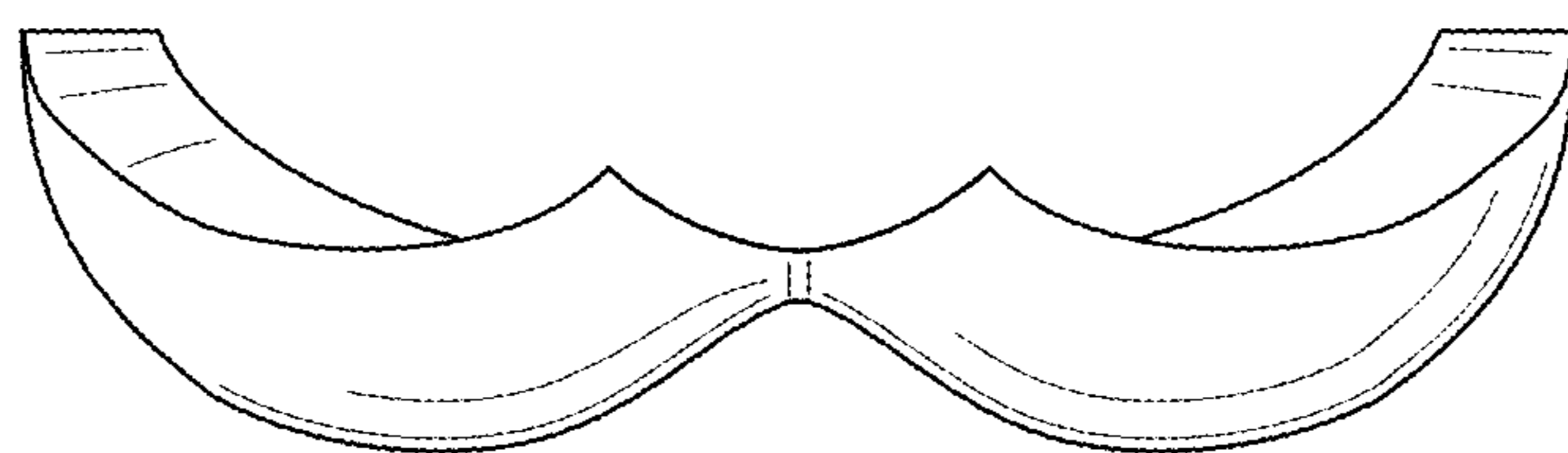

FIG. 7

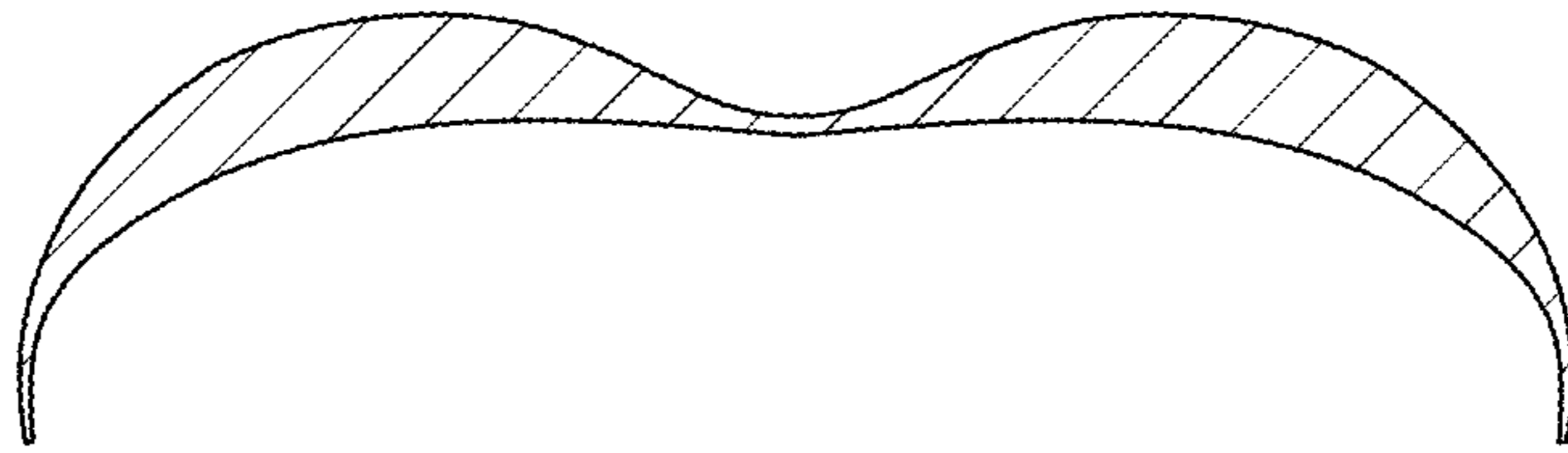

FIG. 8

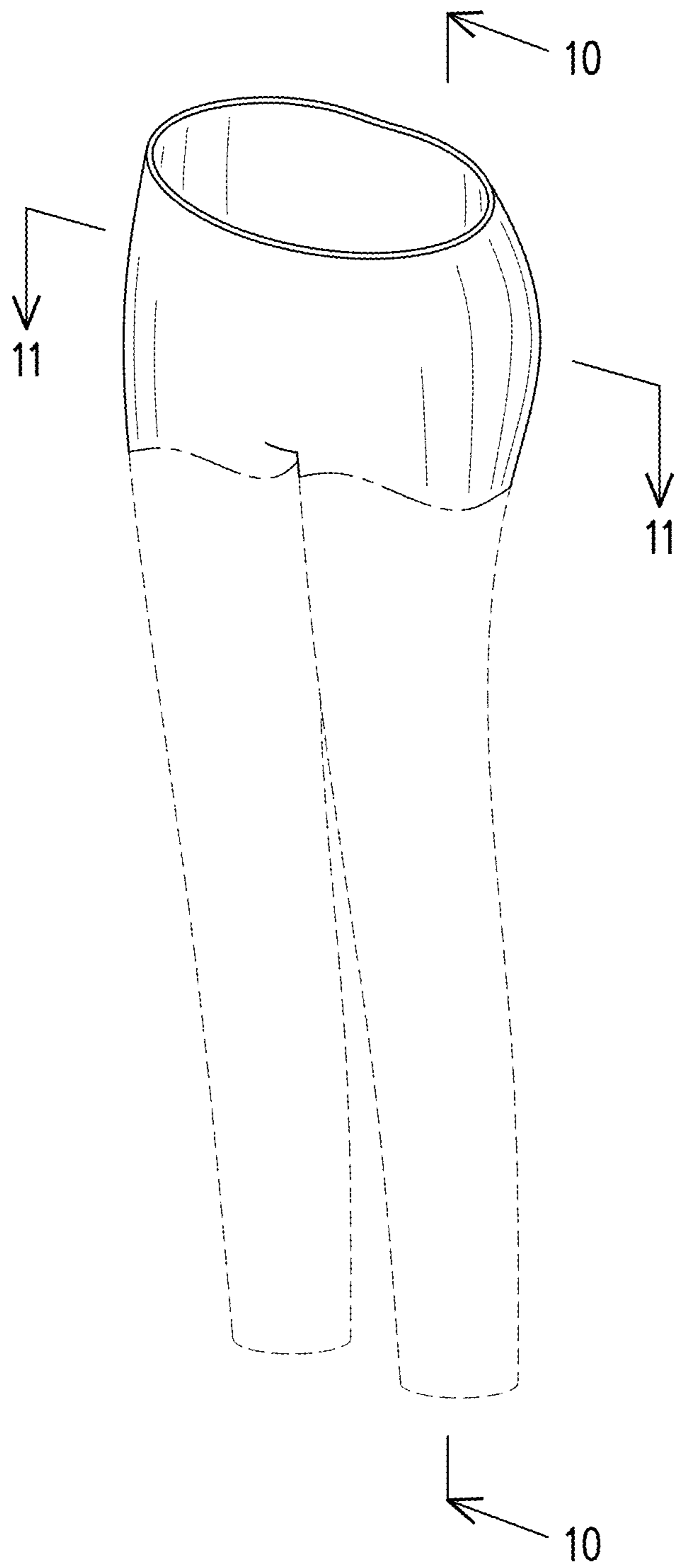

FIG. 9



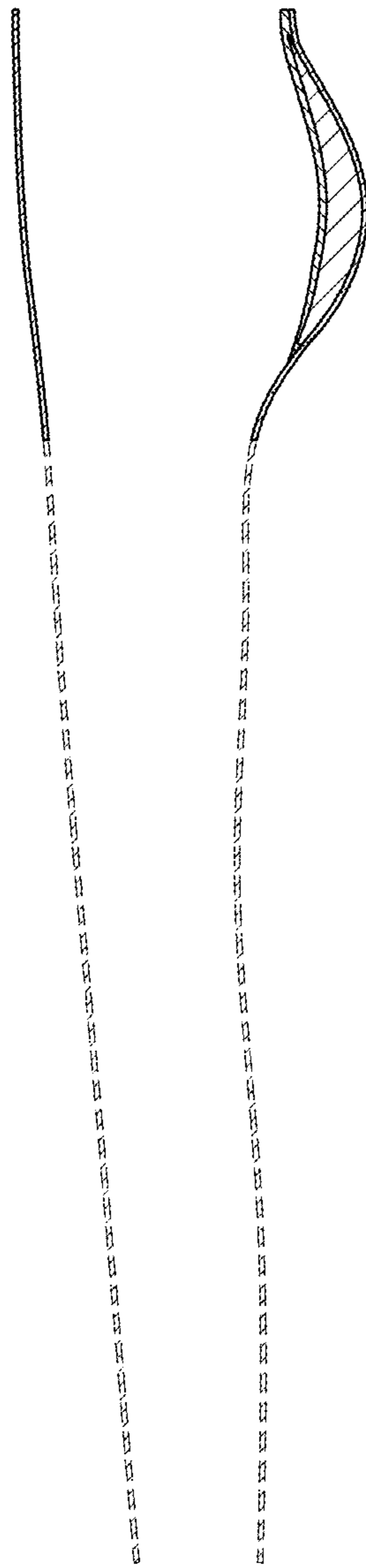

FIG. 10

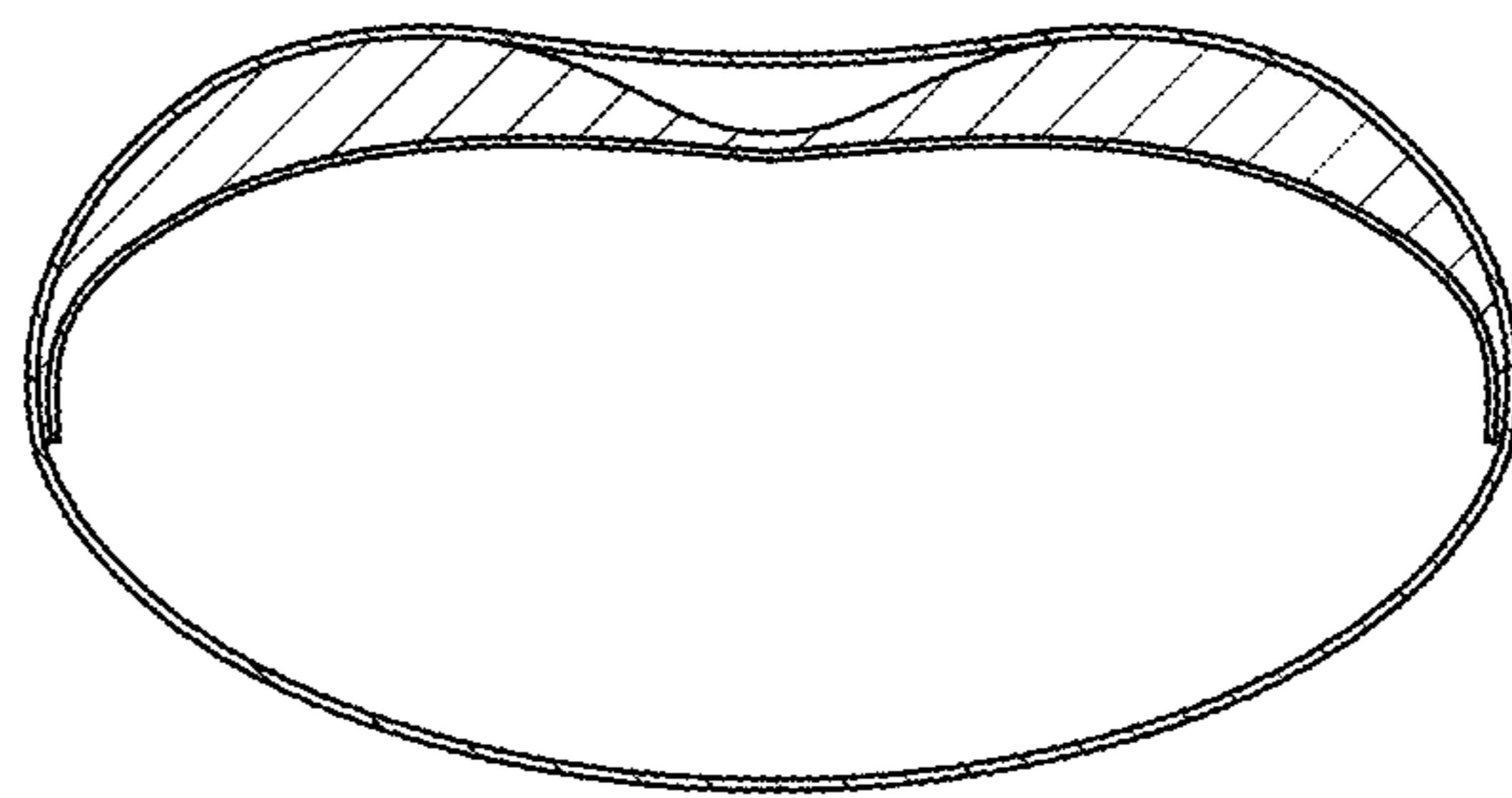

FIG. 11

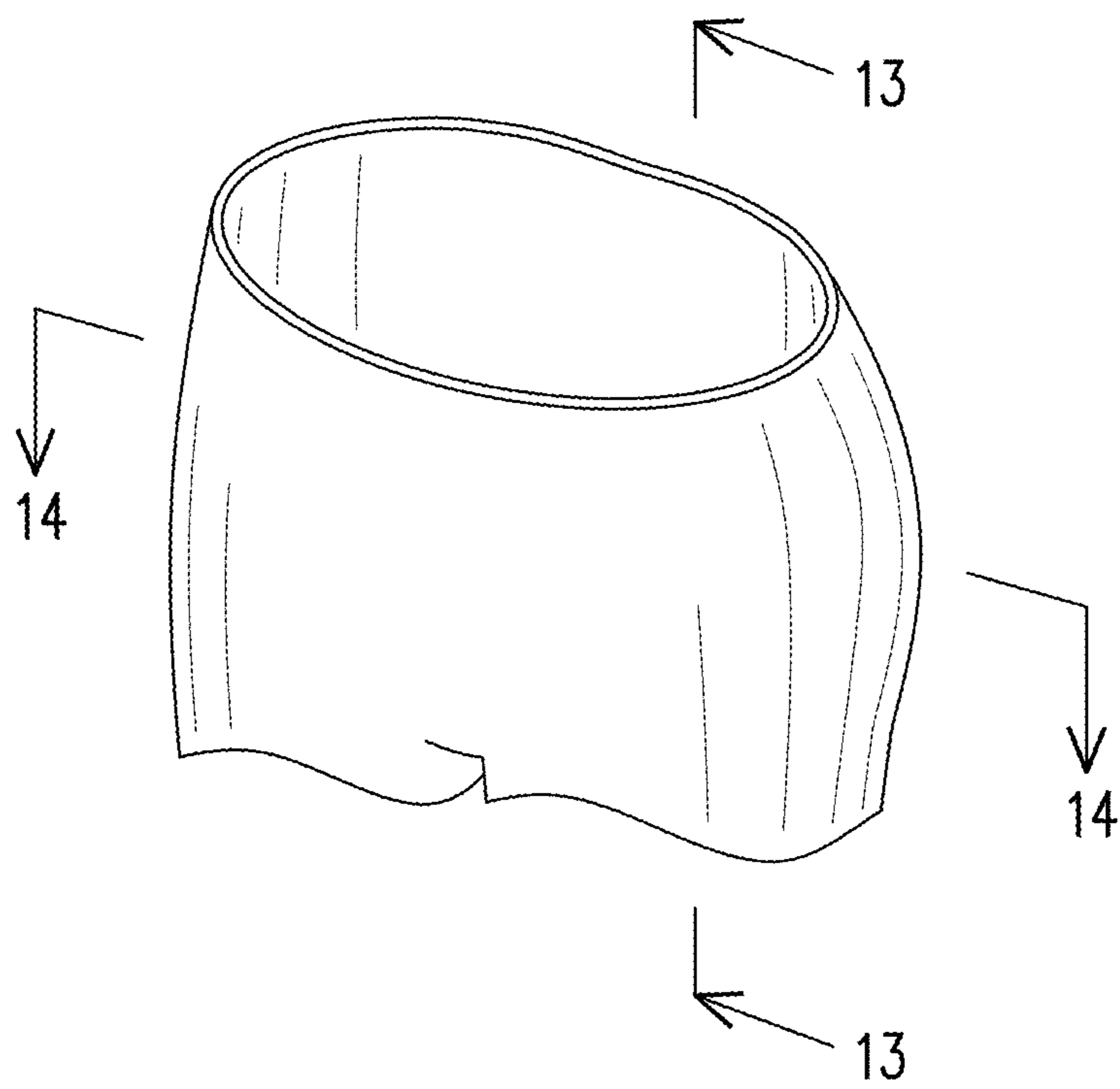

FIG. 12

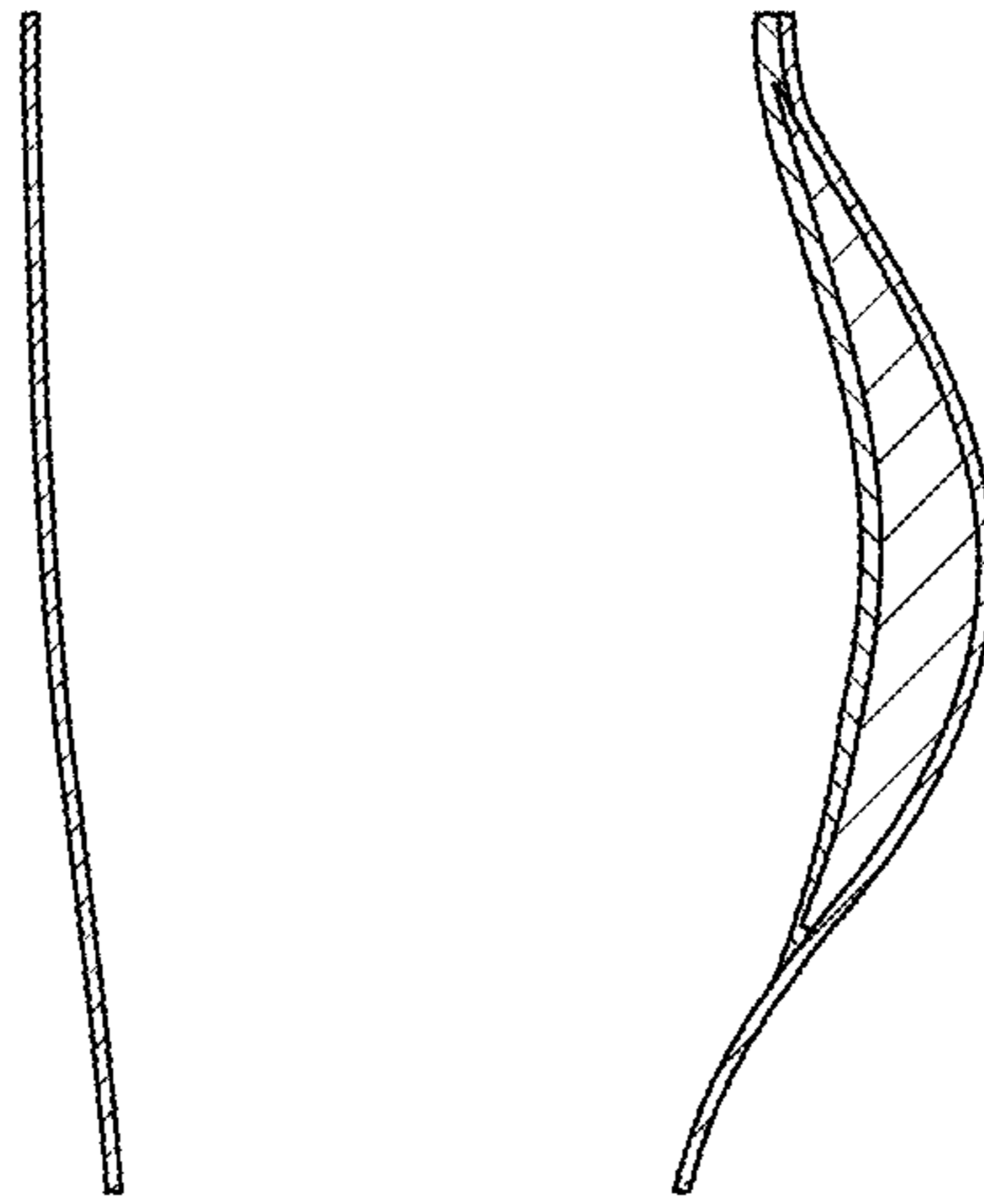

FIG. 13

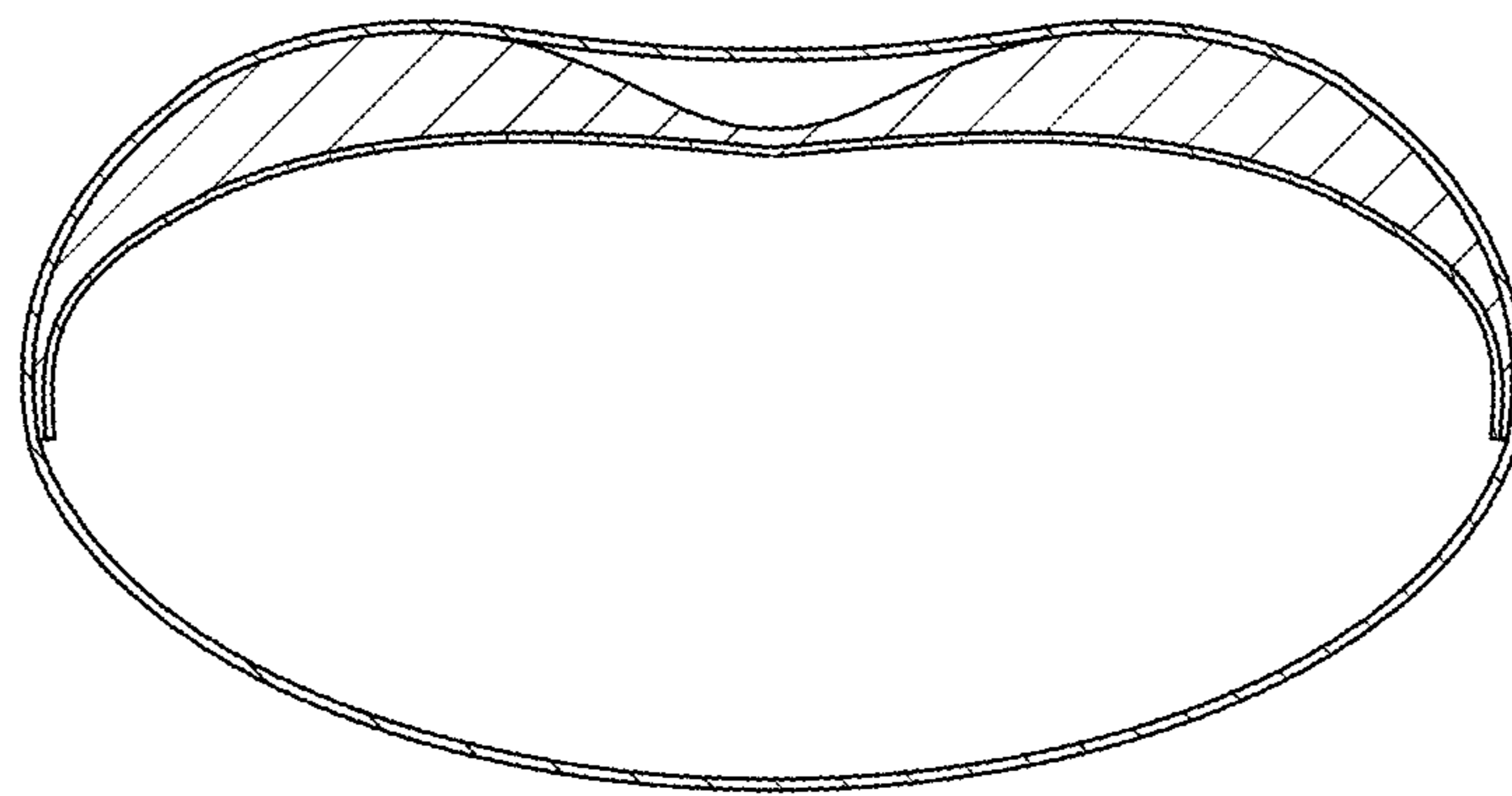

FIG. 14

UNITED STATES PATENT AND TRADEMARK OFFICE  
**CERTIFICATE OF CORRECTION**

PATENT NO. : D960,489 S  
APPLICATION NO. : 29/692012  
DATED : August 16, 2022  
INVENTOR(S) : Jian Cai

Page 1 of 1

It is certified that error appears in the above-identified patent and that said Letters Patent is hereby corrected as shown below:

On the Title Page

In Item (12), correct the name to read, Cai et al.

Please change the current inventor to the following inventors:

Jian Cai  
20736 Lycoming St  
Walnut  
CA  
91789  
USA

Jeremy Penny Cai  
20736 Lycoming St  
Walnut  
CA  
91789  
USA

Jalen Prince Cai  
20736 Lycoming St  
Walnut  
CA  
91789  
USA

Signed and Sealed this  
Fourth Day of June, 2024

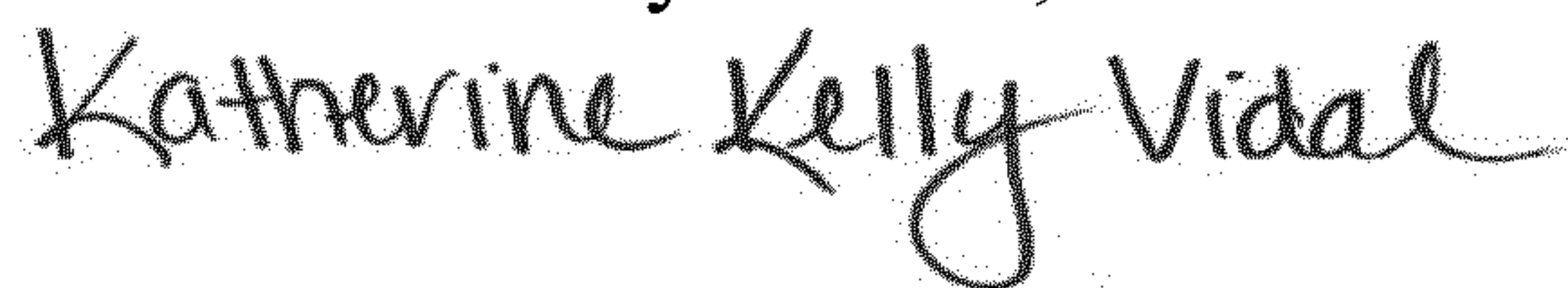

Katherine Kelly Vidal  
*Director of the United States Patent and Trademark Office*