



US00D960421S

(12) **United States Design Patent**
Xia

(10) **Patent No.:** **US D960,421 S**

(45) **Date of Patent:** **** Aug. 9, 2022**

(54) **LAWN LIGHT**

(71) Applicant: **Shenzhen Guangyin Industrial Co., Ltd.**, Shenzhen (CN)

(72) Inventor: **Jianxin Xia**, Shenzhen (CN)

(73) Assignee: **Shenzhen Guangyin Industrial Co., Ltd.**, Shenzhen (CN)

(**) Term: **15 Years**

(21) Appl. No.: **29/800,662**

(22) Filed: **Jul. 22, 2021**

(51) **LOC (13) Cl.** **26-05**

(52) **U.S. Cl.**
USPC **D26/67**

(58) **Field of Classification Search**
USPC D26/67-70
CPC .. F21S 8/022; F21S 8/032; F21S 8/036; F21S 8/081; F21S 8/083; F21S 8/088; F21S 9/02; F21S 9/037; F21S 10/046; F21V 21/0824; F21W 2111/02; F21W 2111/023; F21W 2131/109

See application file for complete search history.

(56) **References Cited**

U.S. PATENT DOCUMENTS

7,041,899	B2 *	5/2006	Stekelenburg	H01R 25/00	174/53
D555,278	S	11/2007	Sanoner			
D556,933	S	12/2007	Sanoner			
D834,515	S *	11/2018	Zhang	D13/102	
D882,144	S *	4/2020	Zhu	D26/67	
D884,246	S *	5/2020	Tang	D26/67	
D890,401	S *	7/2020	Zeng	D26/68	

D911,574	S *	2/2021	Hui	D26/68	
D923,847	S *	6/2021	Ye	D26/67	
D924,458	S *	7/2021	Tang	D26/67	
2006/0044785	A1 *	3/2006	Lee	F21S 8/00	362/276
2006/0187656	A1 *	8/2006	Kuelbs	F21S 9/035	362/183
2019/0128486	A1 *	5/2019	Hollinger	F21S 9/037	

OTHER PUBLICATIONS

ARMXY Solar Ground Lights, ASIN: B09RZZB18W. Available from amazon.com Feb. 8, 2022. (Year: 2022).*
MXWCY Solar Ground Light, ASIN: B09NNL3R5N. Available from amazon.com Dec. 15, 2021. (Year: 2021).*

* cited by examiner

Primary Examiner — Clare E Heflin

(74) *Attorney, Agent, or Firm* — Georgi Korobanov

(57) **CLAIM**

The ornamental design for a lawn light, as shown and described.

DESCRIPTION

FIG. 1 is a perspective view of a lawn light showing my new design;

FIG. 2 is another perspective view thereof;

FIG. 3 is a front view thereof;

FIG. 4 is a rear view thereof;

FIG. 5 is a left side view thereof;

FIG. 6 is a right side view thereof;

FIG. 7 is a top plan view thereof; and,

FIG. 8 is a bottom plan view thereof.

The broken lines depict portions of the lawn light that form no part of the claimed design.

1 Claim, 8 Drawing Sheets

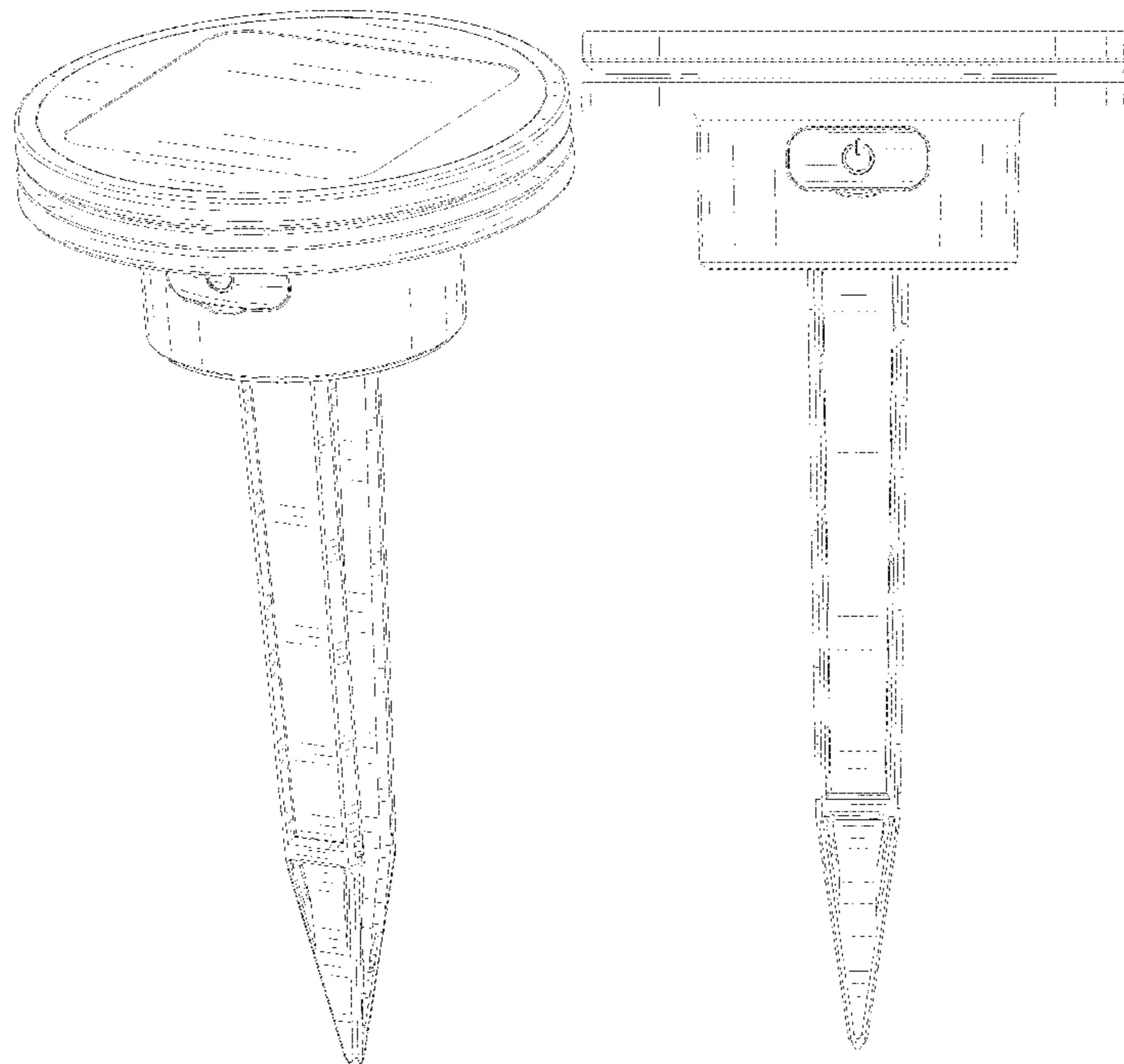

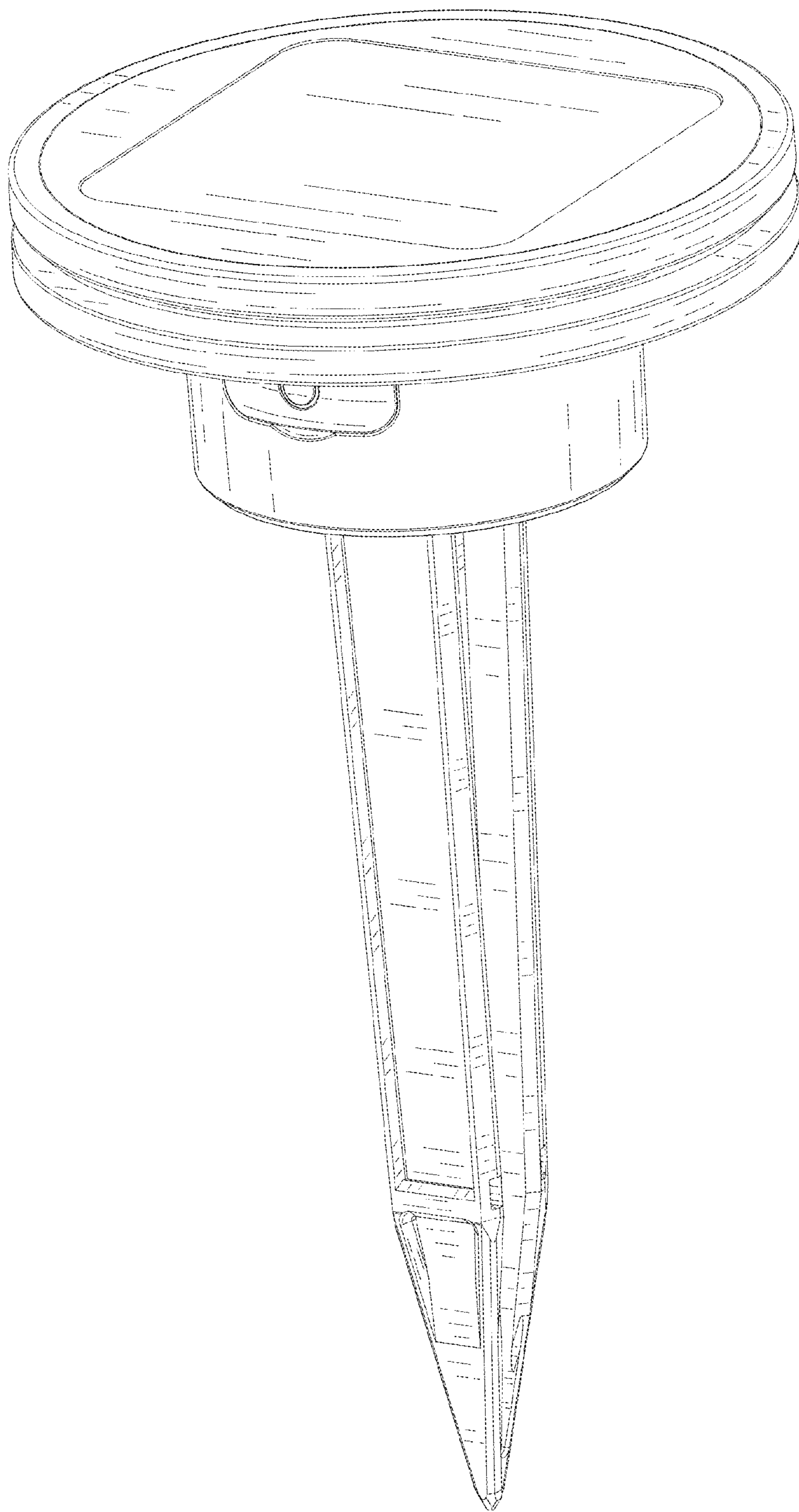

FIG. 1

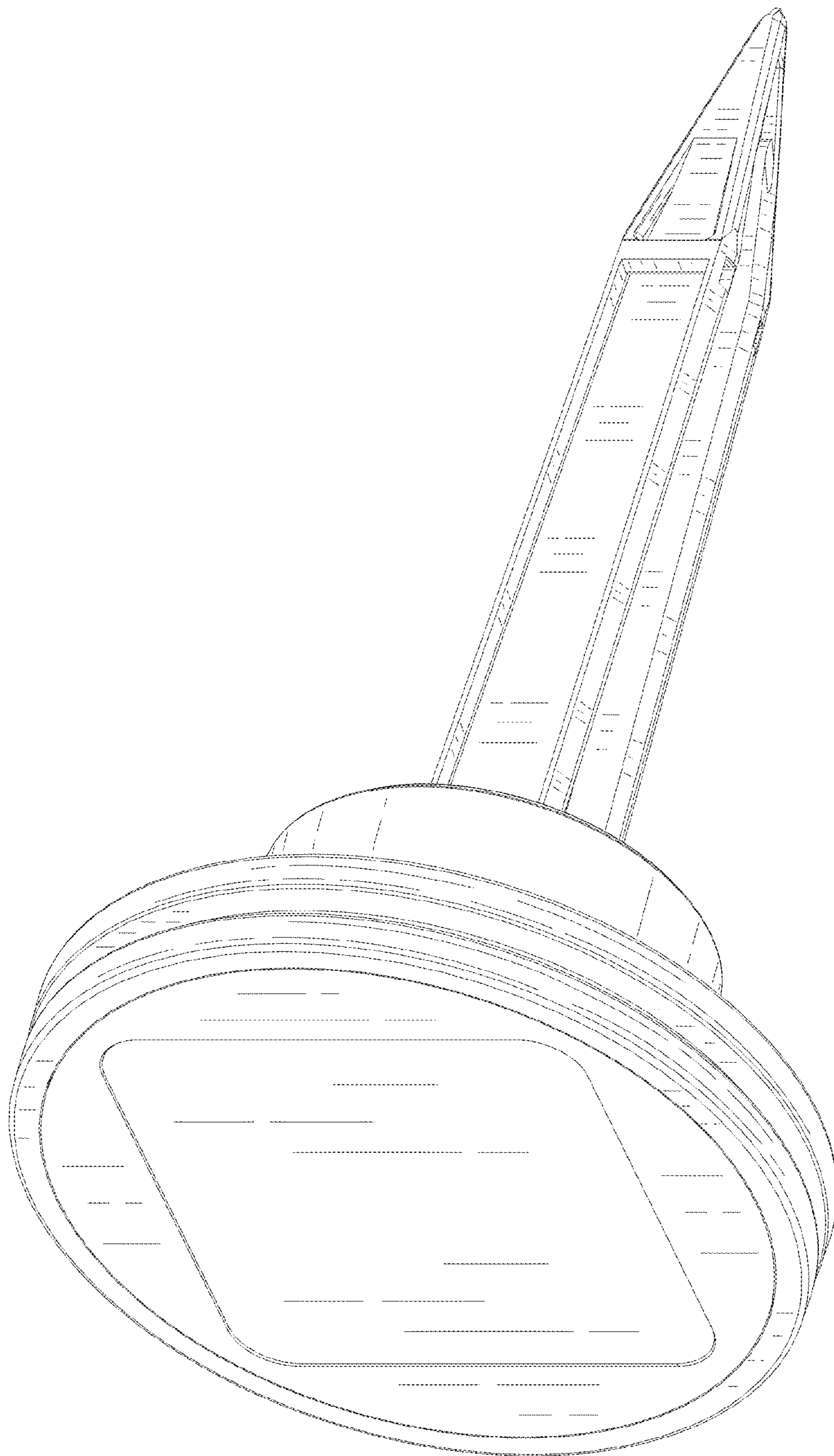

FIG. 2

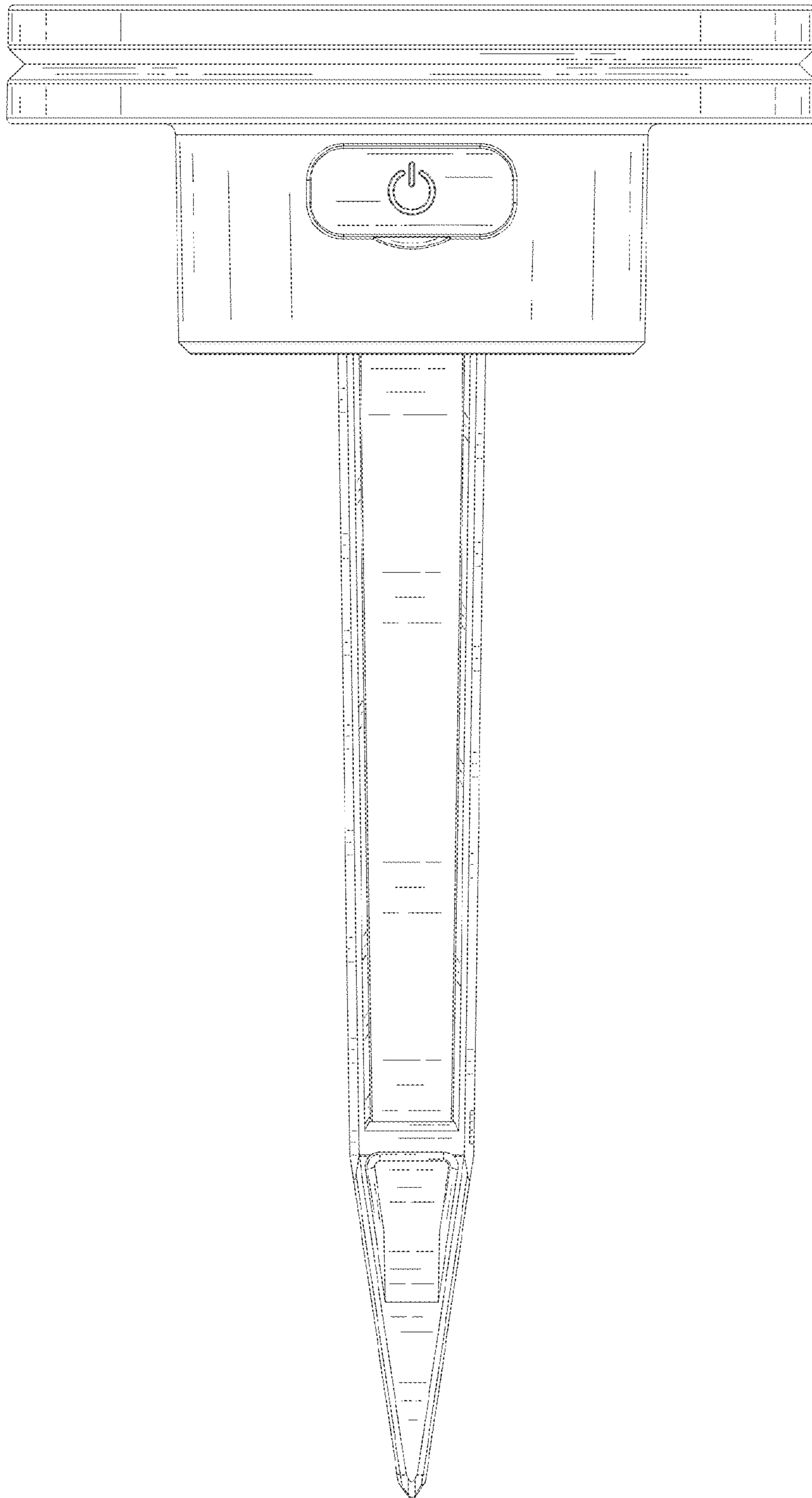

FIG. 3

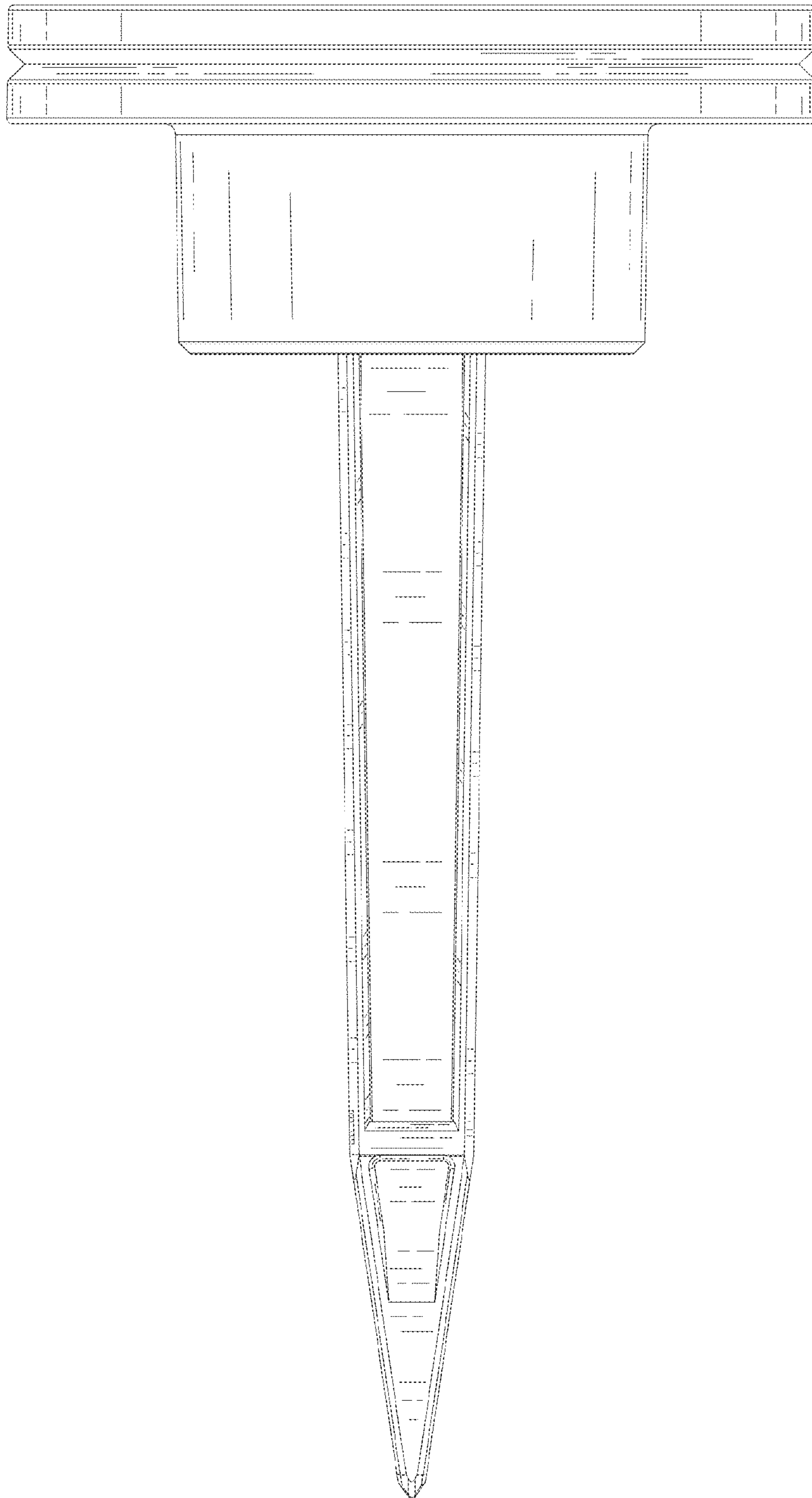

FIG. 4

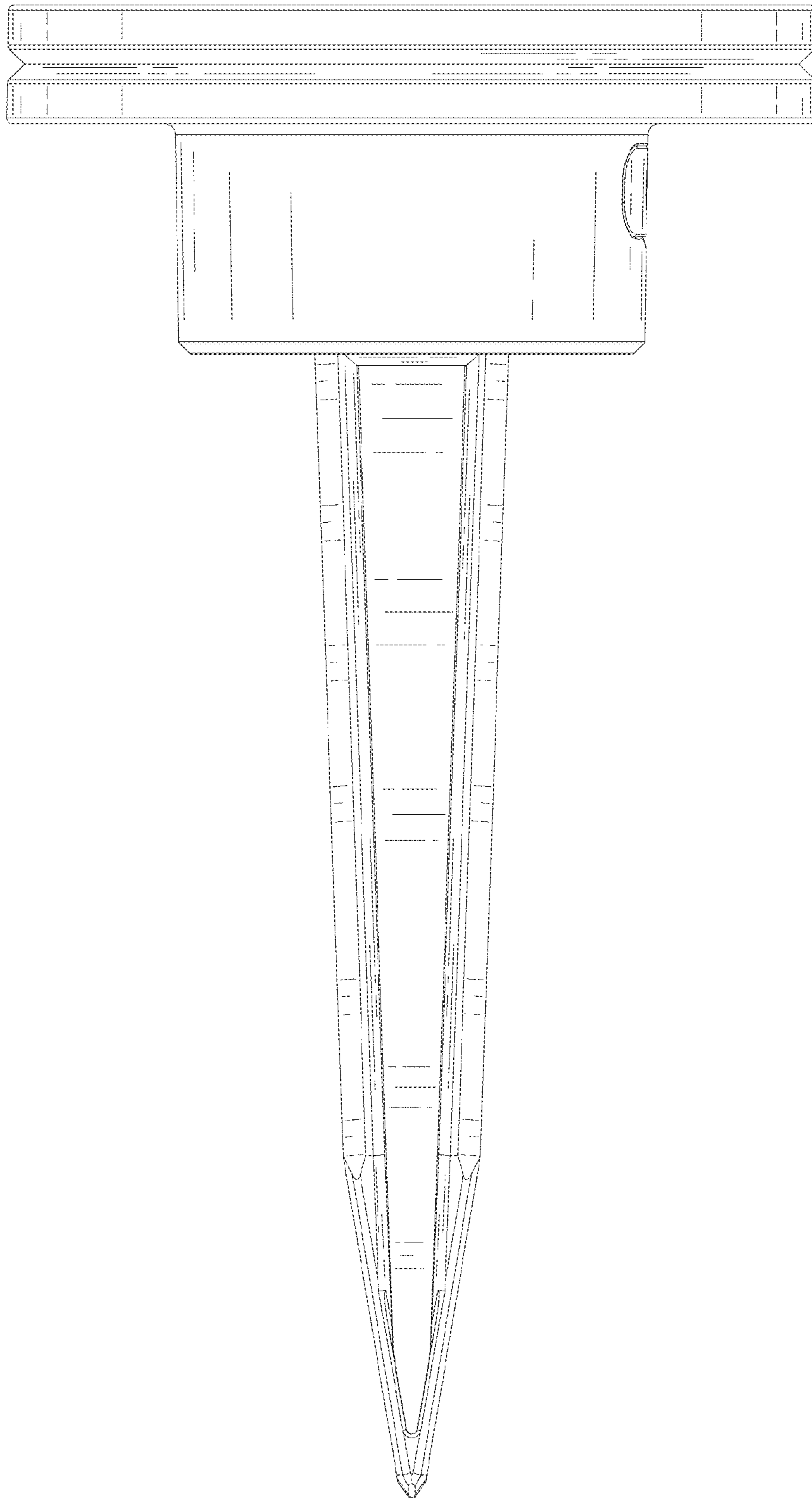

FIG. 5

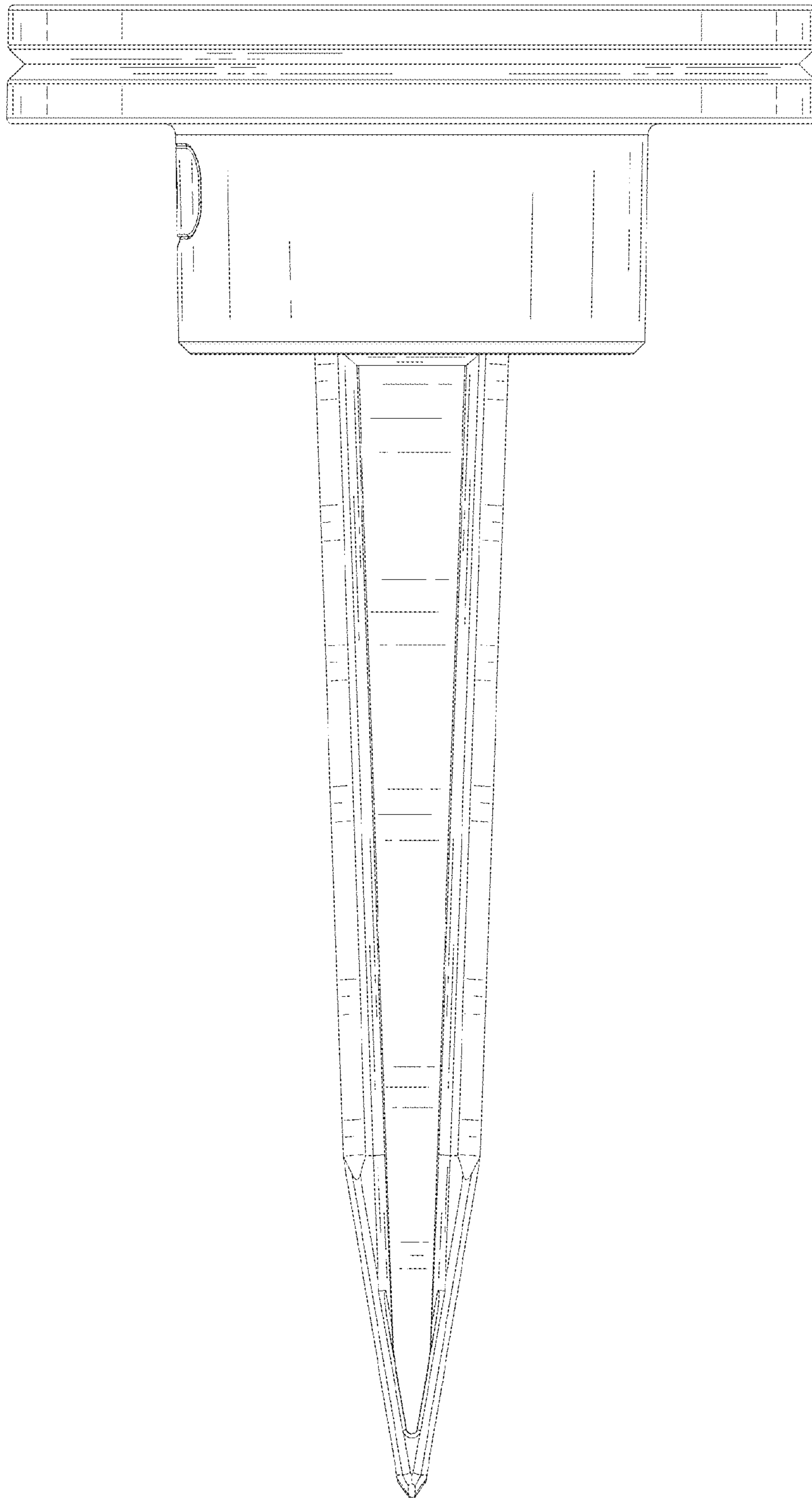

FIG. 6

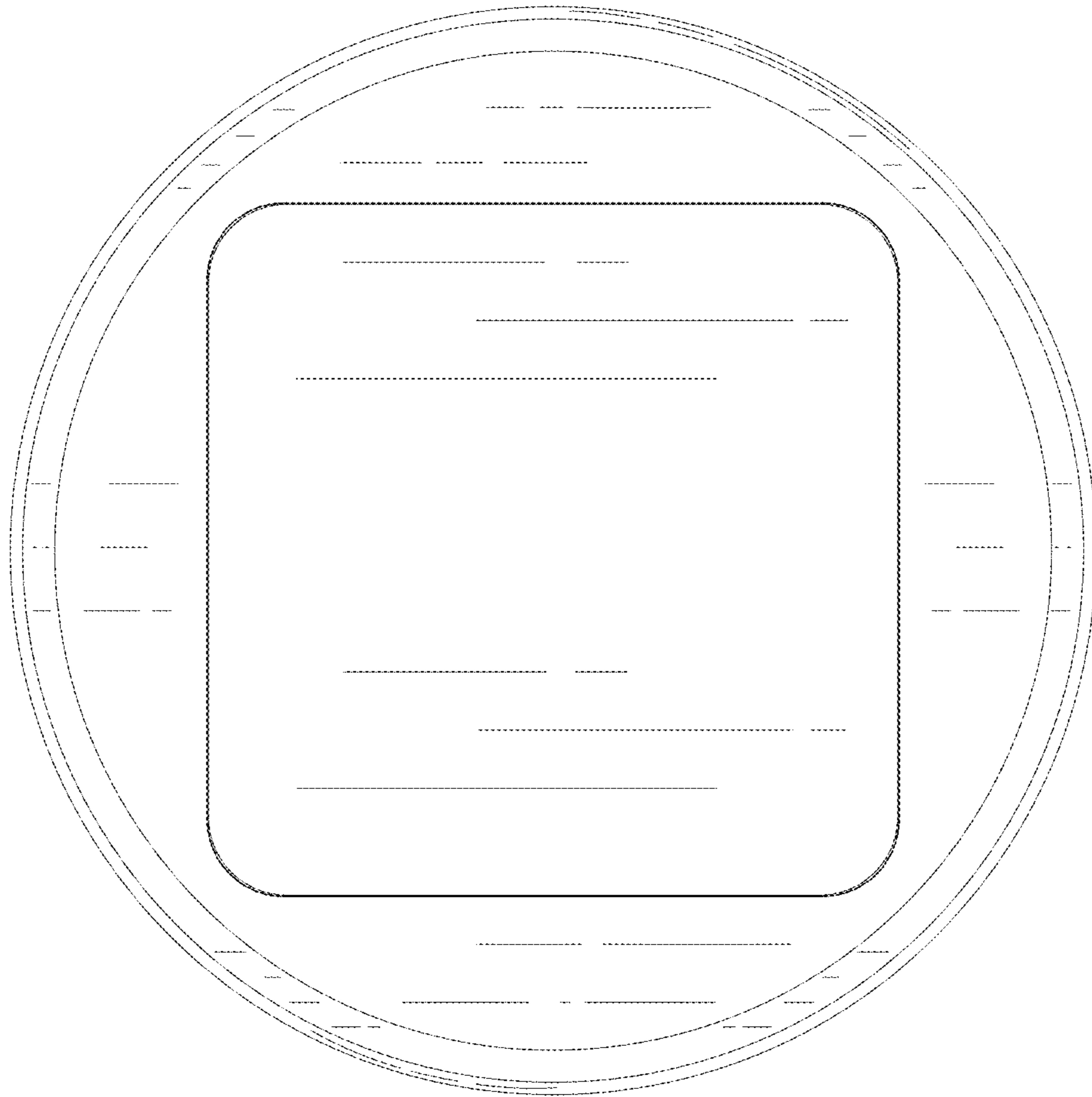

FIG. 7

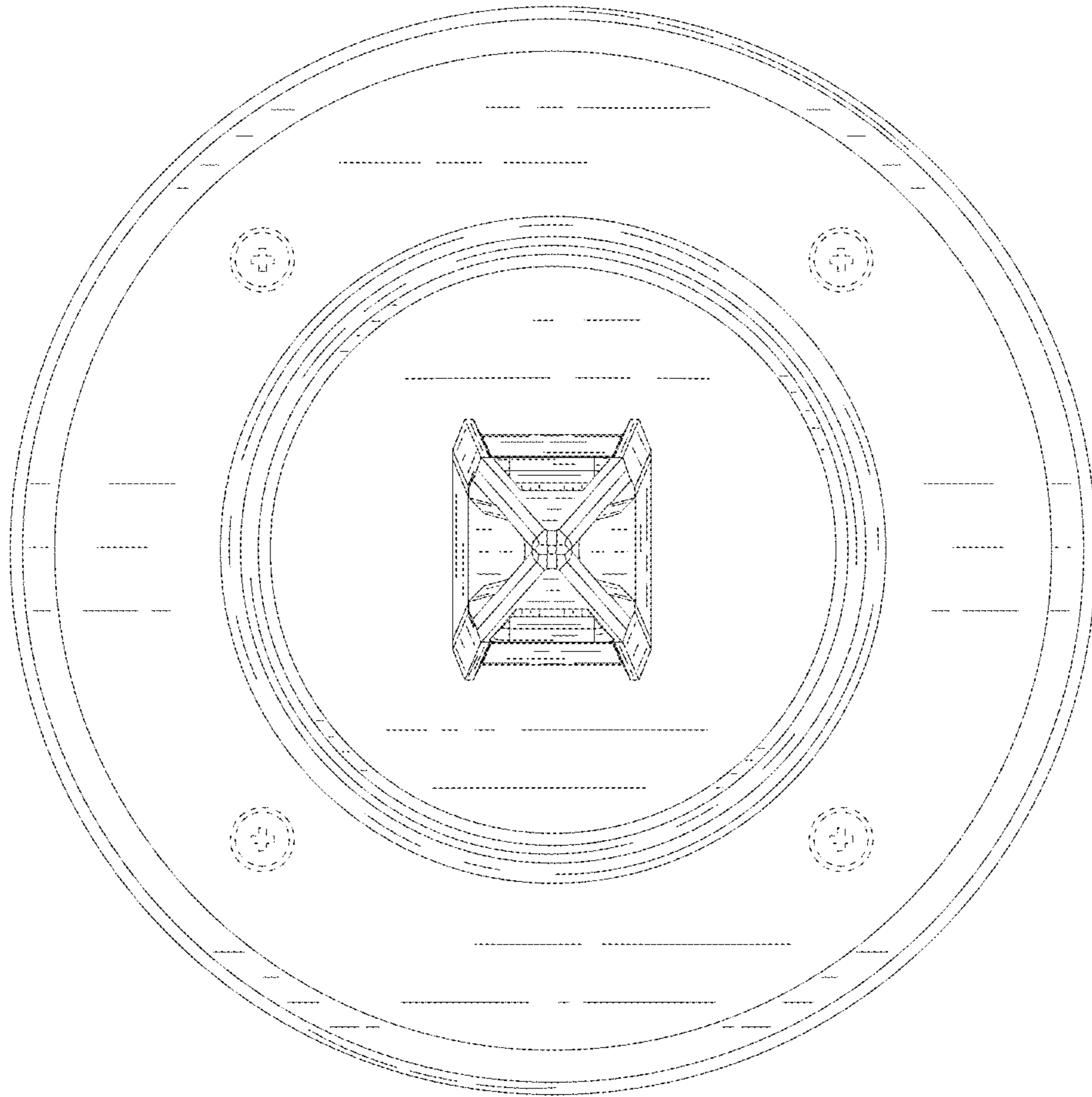

FIG. 8