

US00D960382S

(12) **United States Design Patent** (10) **Patent No.:** **US D960,382 S**
He (45) **Date of Patent:** **** *Aug. 9, 2022**

(54) **MULTIFUNCTIONAL BLACKHEAD REMOVER**

(71) Applicant: **Xu He**, Anhui (CN)

(72) Inventor: **Xu He**, Anhui (CN)

(*) Notice: This patent is subject to a terminal disclaimer.

(**) Term: **15 Years**

(21) Appl. No.: **29/747,150**

(22) Filed: **Aug. 20, 2020**

(51) **LOC (13) Cl.** **28-03**

(52) **U.S. Cl.**
USPC **D24/214**

(58) **Field of Classification Search**
USPC D24/200, 211, 212, 213, 214, 215;
D8/14.1; D28/13
CPC A61H 2015/0014; A61H 15/00; A61H
2015/0042
See application file for complete search history.

(56) **References Cited**

U.S. PATENT DOCUMENTS

- D425,241 S * 5/2000 Nishizawa D28/9
- D435,913 S * 1/2001 Harris D24/214
- D649,657 S * 11/2011 Petersen D24/215
- D706,433 S * 6/2014 Fuhr D24/200
- D734,479 S * 7/2015 Youngquist D24/209
- D738,516 S * 9/2015 Karim D24/200
- D742,003 S * 10/2015 Tasar D24/146
- D747,800 S * 1/2016 Dunleavy D24/133
- D795,423 S 8/2017 Chen
- D825,073 S 8/2018 Lenke
- D827,842 S * 9/2018 Bainton D24/200
- D827,843 S 9/2018 Bainton
- D837,395 S * 1/2019 Gan D24/214
- D859,681 S 9/2019 Tang

- D860,470 S * 9/2019 Li D24/214
- D861,181 S * 9/2019 Shen D24/209
- D862,717 S * 10/2019 Khubani D24/200
- D862,721 S * 10/2019 Friend D24/214
- D865,209 S * 10/2019 Nichols D24/214
- D866,790 S * 11/2019 Lee D24/215
- D875,267 S * 2/2020 Zeng D24/214
- D895,132 S * 9/2020 Hu D24/215
- D895,825 S * 9/2020 Jin D24/214
- D895,829 S * 9/2020 Hu D24/215
- D897,109 S * 9/2020 Blank D4/102
- D897,110 S * 9/2020 Blank D4/102
- D897,552 S * 9/2020 Meissner D24/215
- D900,329 S * 10/2020 Xu D24/215
- D906,530 S * 12/2020 Liu D24/214
- D907,789 S * 1/2021 Shenfarber D24/209
- D908,232 S * 1/2021 Shenfarber D24/209
- D908,234 S * 1/2021 Elosegui Zabalegui D24/215
- D909,563 S * 2/2021 Hou D24/108
- D912,263 S * 3/2021 Chen D24/214
- D912,323 S * 3/2021 An D28/44.1
- D912,840 S * 3/2021 Li D24/215
- D925,752 S * 7/2021 Wang D24/214
- D927,010 S * 8/2021 He D24/215

(Continued)

Primary Examiner — Michael A Maharajh

(57) **CLAIM**

The ornamental design for a multifunctional blackhead remover, as shown and described.

DESCRIPTION

FIG. 1 is a perspective view of a multifunctional blackhead remover showing my new design;
FIG. 2 is a front elevational view thereof;
FIG. 3 is a rear elevational view thereof;
FIG. 4 is a left side elevational view thereof;
FIG. 5 is a right side elevational view thereof;
FIG. 6 is a top plan view thereof; and,
FIG. 7 is a bottom plan view thereof.

1 Claim, 7 Drawing Sheets

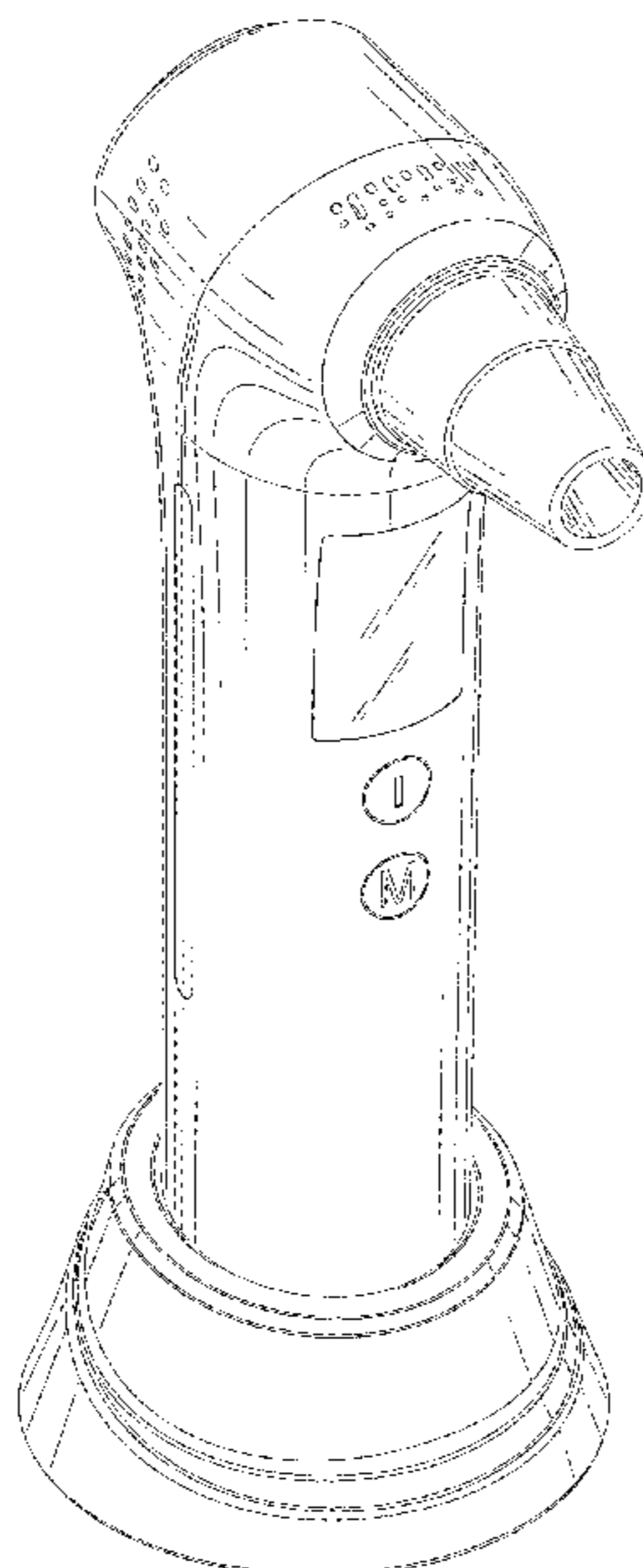

(56)

References Cited

U.S. PATENT DOCUMENTS

2004/0236254 A1* 11/2004 Nichols A61H 9/005
601/6
2012/0065555 A1* 3/2012 Chae A61H 23/0263
601/18
2012/0197357 A1* 8/2012 Dewey A61N 5/0616
607/89
2013/0030506 A1* 1/2013 Bartolone A61N 5/0616
607/89
2014/0121631 A1* 5/2014 Bean A61N 5/0616
604/500
2015/0182415 A1* 7/2015 Olkowski A61F 9/00772
601/93
2020/0179220 A1* 6/2020 Jablow A61H 1/00

* cited by examiner

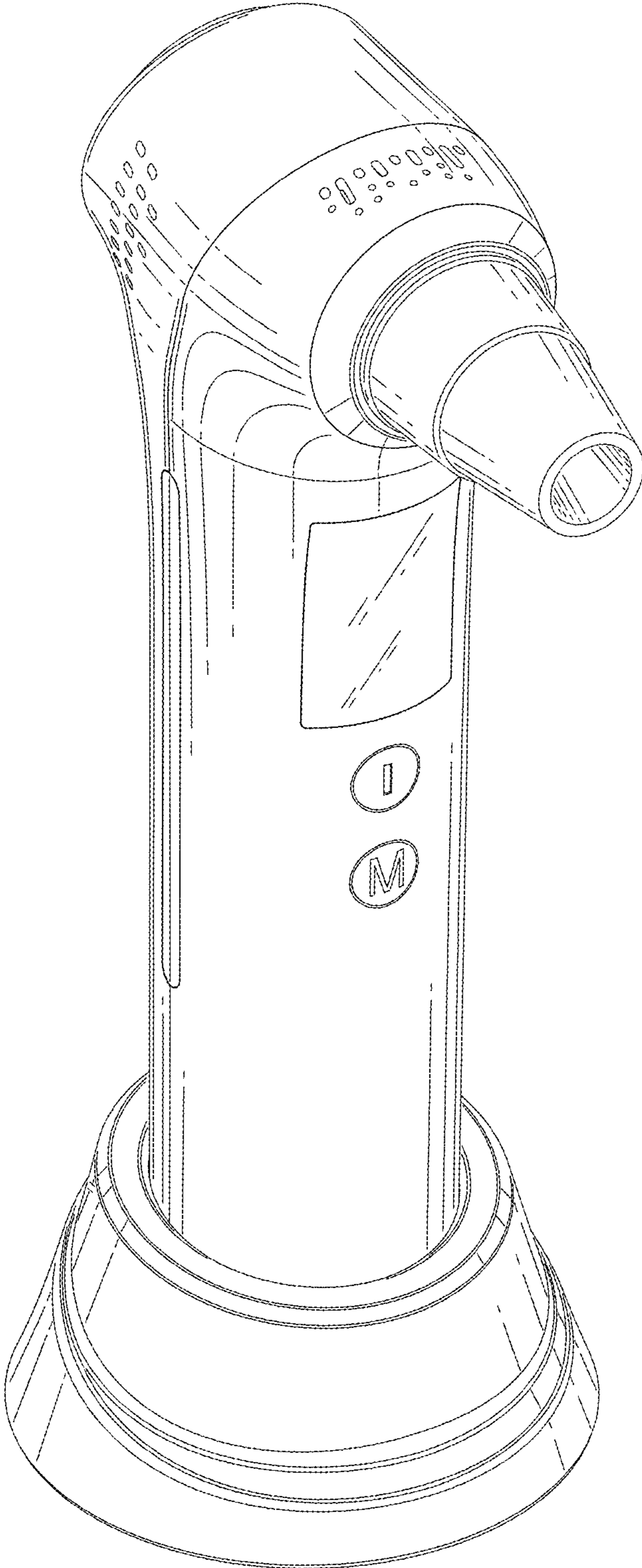

FIG.1

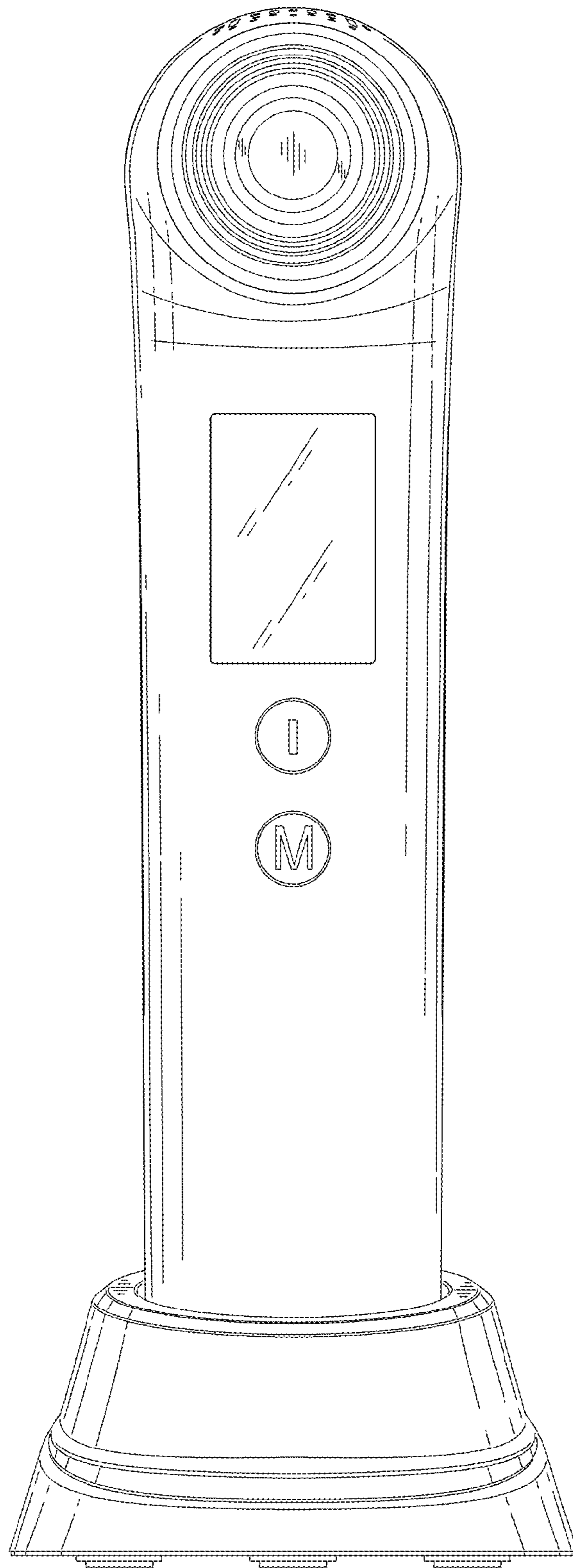

FIG.2

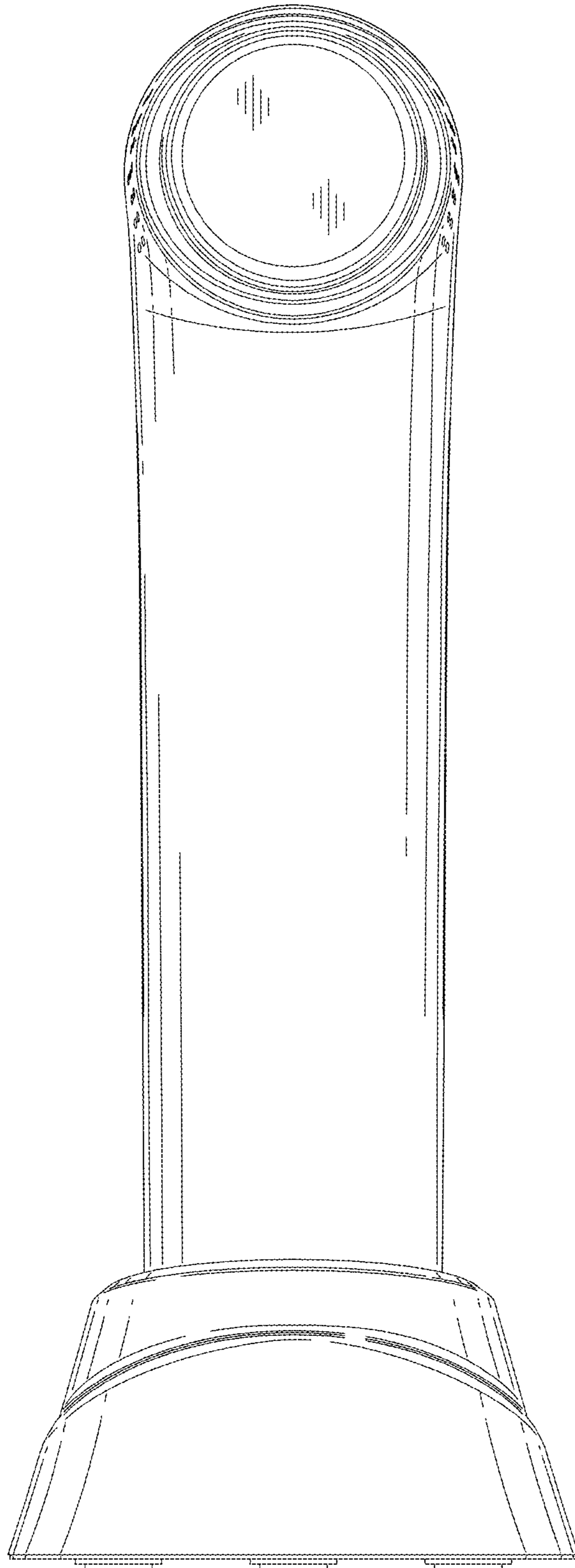

FIG. 3

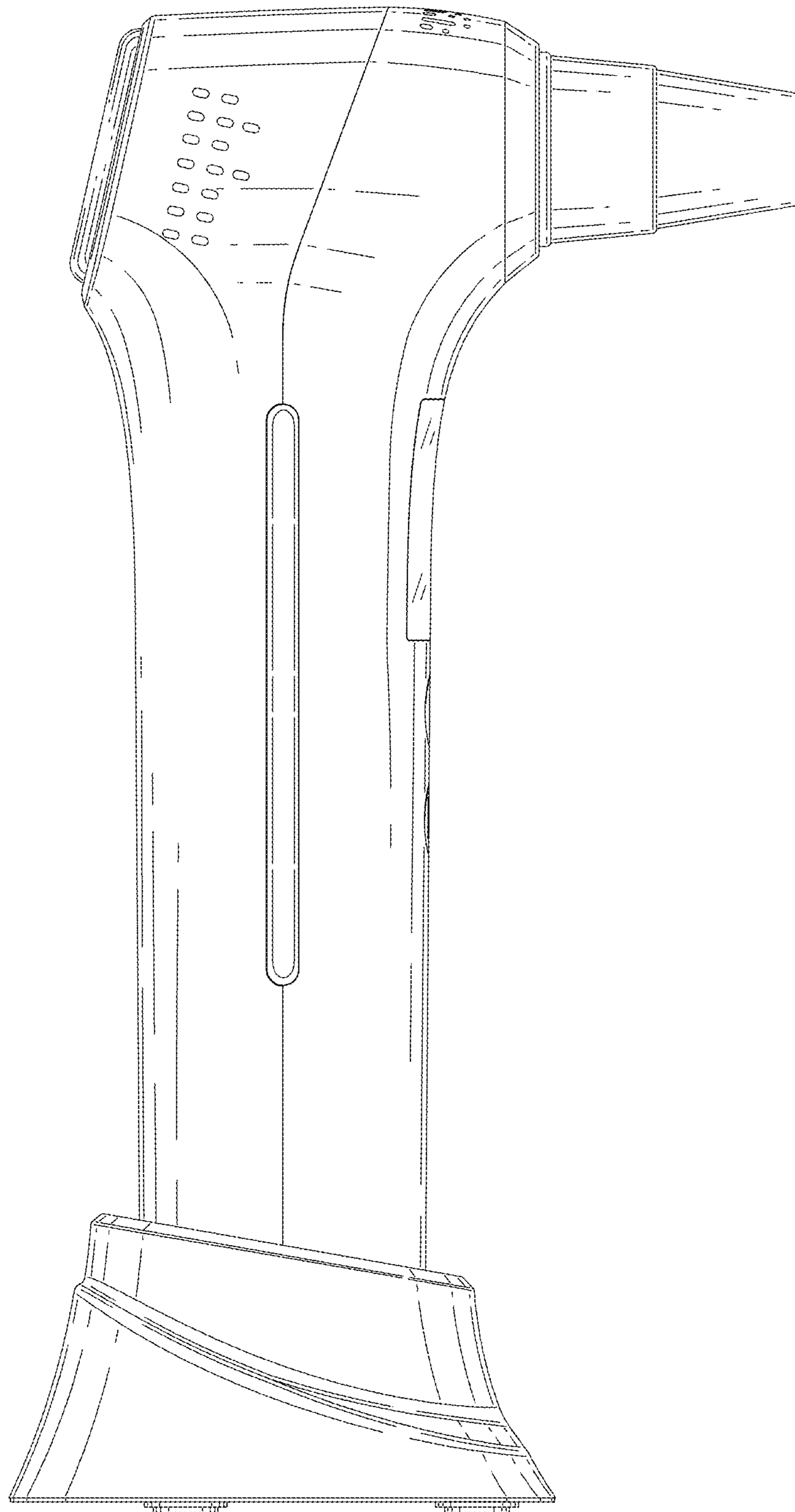

FIG.4

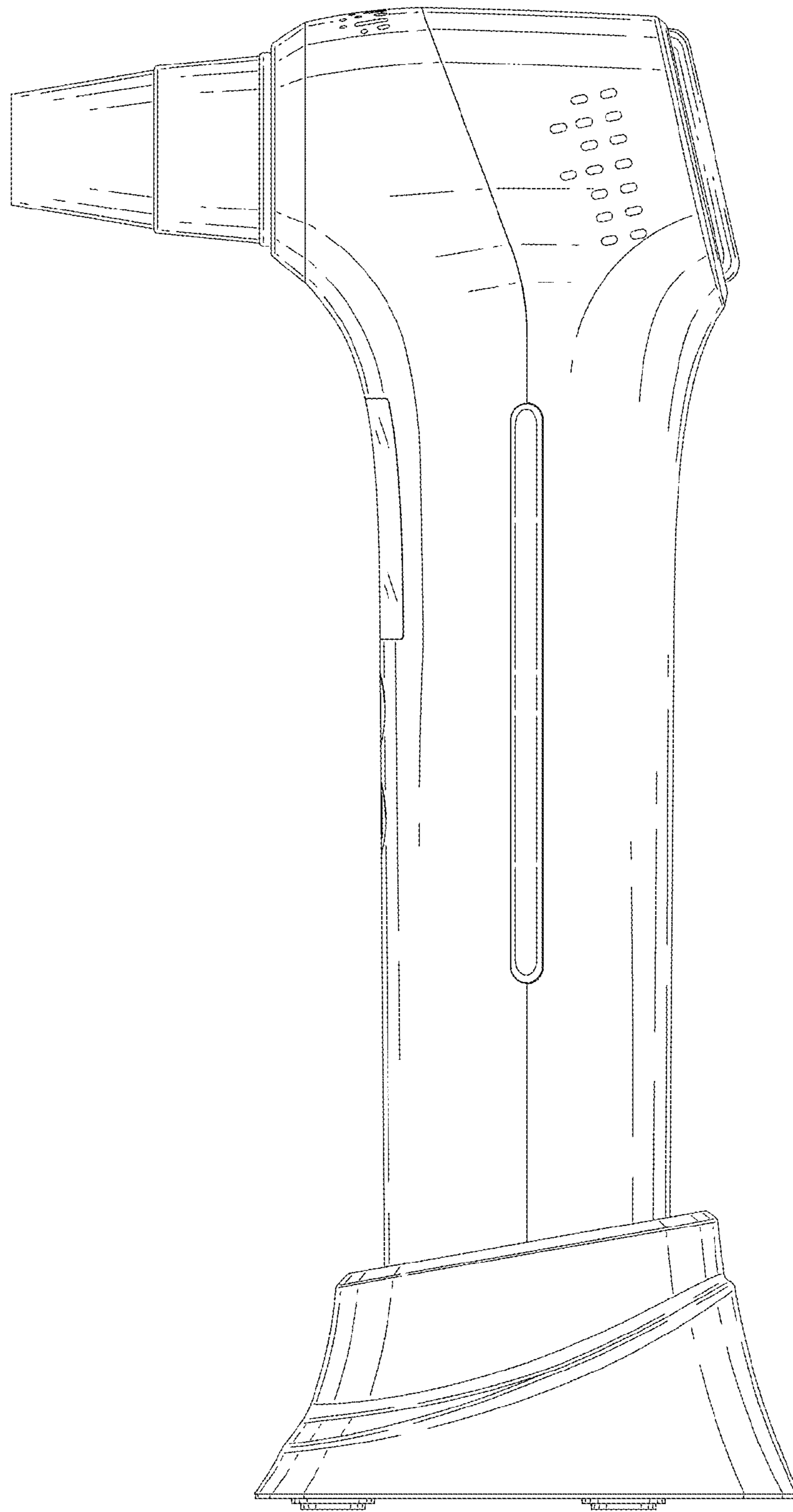

FIG.5

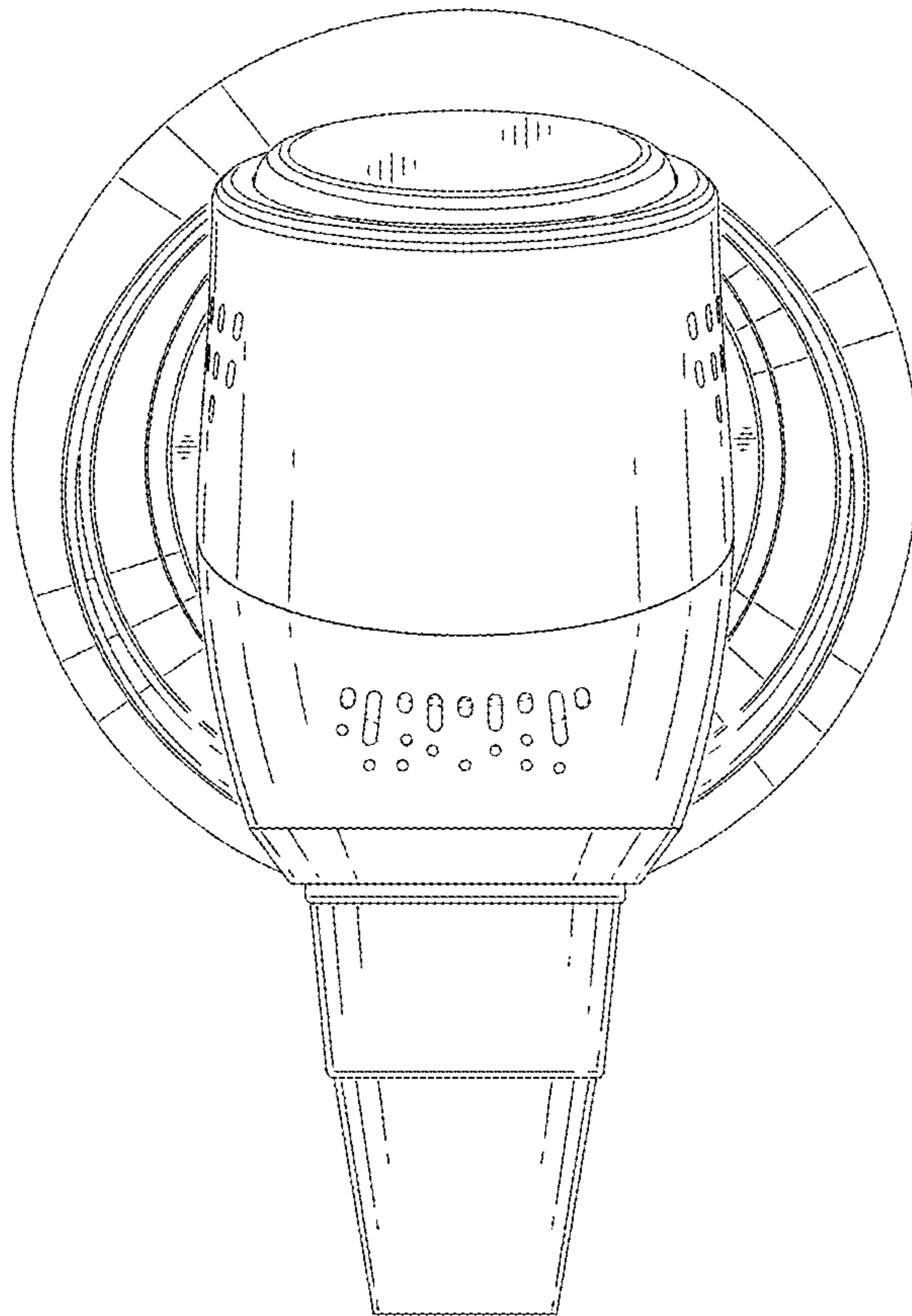

FIG.6

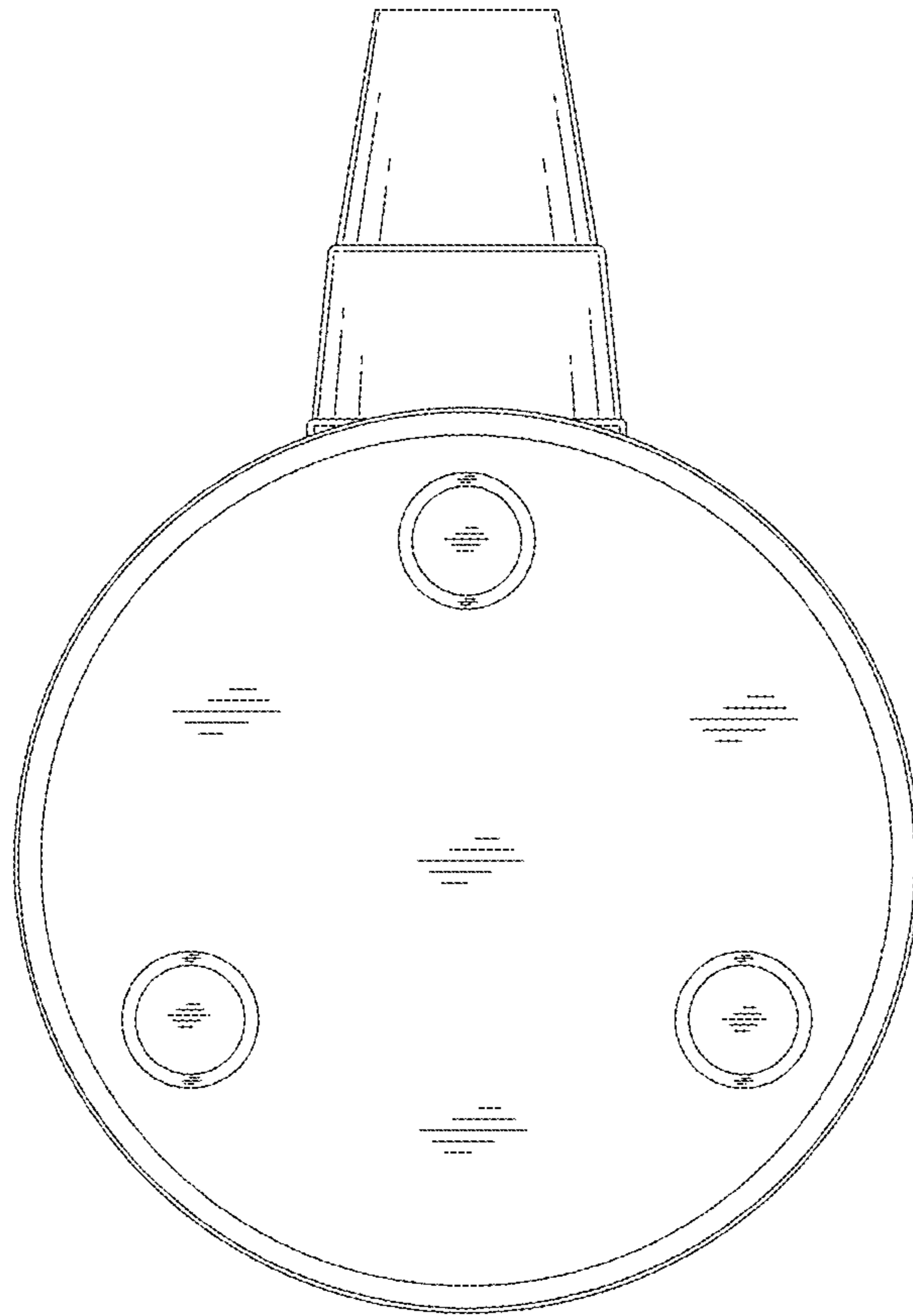

FIG.7