



US00D960352S

(12) **United States Design Patent** (10) **Patent No.:** **US D960,352 S**
Ngo (45) **Date of Patent:** **** Aug. 9, 2022**

(54) **FACE MASK**

FOREIGN PATENT DOCUMENTS

(71) Applicant: **Simpler Products LLC**, Sunnyvale, CA (US)

CN 306299629 * 8/2020
CN 306446239 * 11/2020

(72) Inventor: **Kevin Ngo**, Sunnyvale, CA (US)

OTHER PUBLICATIONS

(73) Assignee: **AIR FLO LABS, LLC**, Sunnyvale, CA (US)

Honeywell North Half Mask Respirator, Date unknown, grainger.com [online], [site visited Dec. 9, 2021], Available from internet, URL: <https://www.grainger.com/product/HONEYWELL-NORTH-Half-Mask-Respirator-Kit-3NML4> (Year: 2021).*

(**) Term: **15 Years**

(Continued)

(21) Appl. No.: **29/754,681**

(22) Filed: **Oct. 13, 2020**

Primary Examiner — Wendy L Arminio
Assistant Examiner — Maheen Khurshid

(51) **LOC (13) Cl.** **29-02**

(52) **U.S. Cl.**
USPC **D24/110.1**

(57) **CLAIM**

(58) **Field of Classification Search**
USPC D24/110.1, 108, 110–110.4, 110.6, 162, D24/164; D29/102, 105–108, 110
CPC A61M 16/00; A62B 7/00; A62B 18/00; A62B 18/02; A62B 18/025; A62B 18/084; A62B 18/086; A62B 18/01; A62B 18/04; A62B 18/08; A62B 23/00; A41D 13/11; A41D 13/1107; A41D 13/1115; A41D 13/1123; A41D 13/113; A41D 13/1161

I claim the ornamental design for a face mask, as shown and described.

See application file for complete search history.

DESCRIPTION

(56) **References Cited**

U.S. PATENT DOCUMENTS

D130,687 S * 12/1941 Lehmborg D24/110.6
D478,660 S * 8/2003 Mault D24/110.1
D640,011 S * 6/2011 Teng D29/108
D788,373 S * 5/2017 Bunge D29/108
D928,305 S * 8/2021 Holbrook D24/110.1
2008/0295843 A1 * 12/2008 Haas A41D 13/1192
128/205.27
2015/0034098 A1 * 2/2015 Schumacher A62B 23/025
128/863
2016/0317848 A1 * 11/2016 Zilberstein A62B 23/02

FIG. 1 is a front perspective view of a face mask.
FIG. 2 is a front view thereof.
FIG. 3 is a rear view thereof.
FIG. 4 is a left side view thereof.
FIG. 5 is a right side view thereof.
FIG. 6 is a top view thereof.
FIG. 7 is a bottom view thereof.
FIG. 8 is a bottom perspective view thereof; and,
FIG. 9 is a front perspective view thereof as worn by a child person.
The broken line showing portions of the face mask in FIGS. 3 and 8 forms no part of the claimed design.
The broken line showing of the child person in FIG. 9 depicts environment and forms no part of the claimed design.

1 Claim, 9 Drawing Sheets

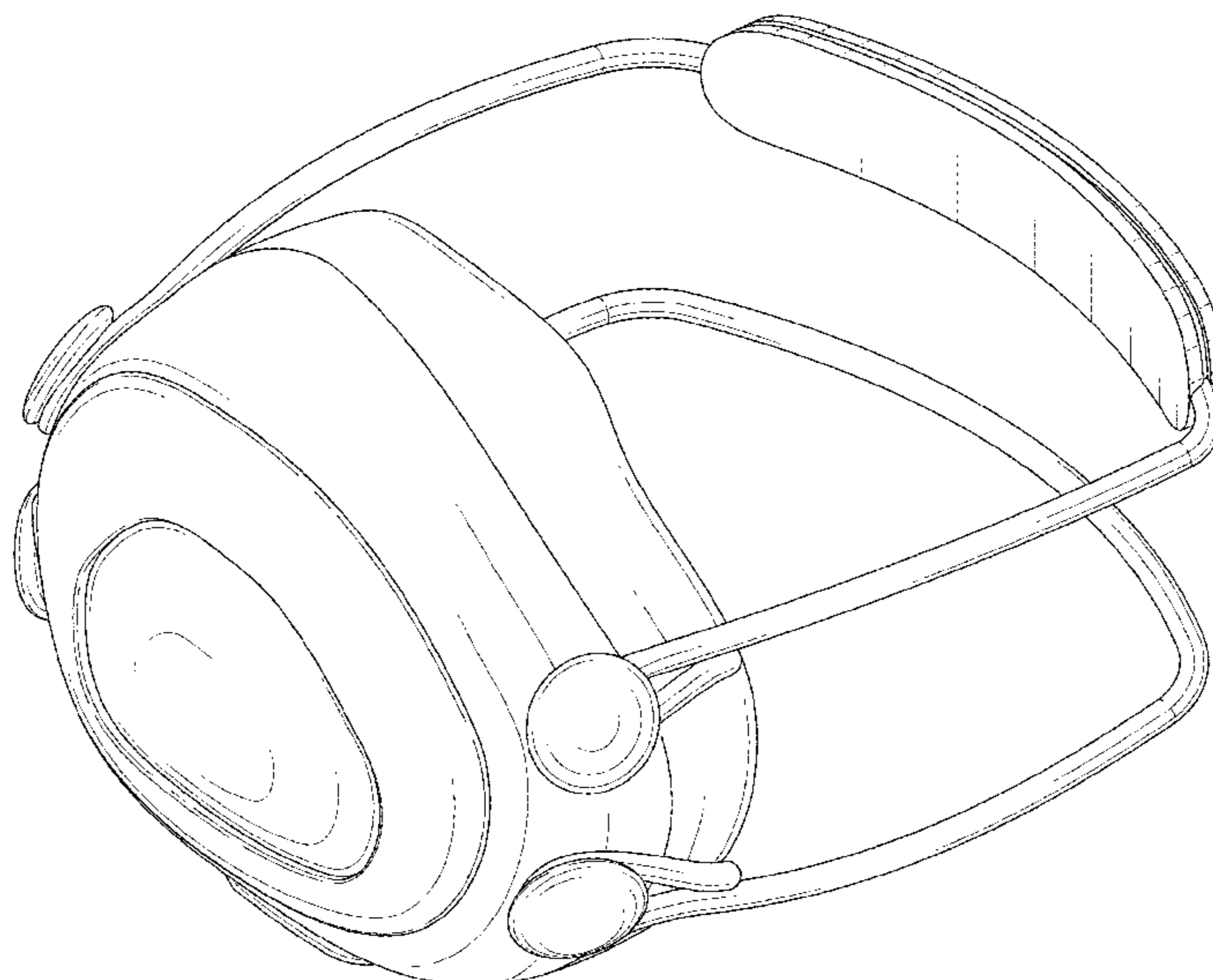

(56)

References Cited

OTHER PUBLICATIONS

Flomask, Nov. 19, 2020, flowmask.com [online], [site visited Dec. 16, 2021], Available from internet, URL: <<https://flomask.com/blogs/news>> (Year: 2020).*

Flo Mask—World's Best Face Mask For Kids, Period, Nov. 20, 2020, indiegogo.com [online], [site visited Dec. 16, 2021], Available from internet, URL: <<https://www.indiegogo.com/projects/flo-mask-world-s-best-face-mask-for-kids-period--2#/updates/all>> (Year: 2020).*

Kids Electric Dust Mask Q8S N95 Respirator, Date first available Jan. 14, 2020, amazon.com [online], [site visited Dec. 16, 2021], Available from internet, URL: <<https://www.amazon.in/respirator-activated-automatic-purifying-dustproof/dp/B082Y1SM93>> (Year: 2020).*

Children's Mask, Electric Mask, Date first available Jun. 7, 2020, amazon.com [online], [site visited Dec. 16, 2021], Available from internet, URL: <<https://www.amazon.com/Childrens-Electric-childrens-purification-automatic/dp/B08C7BR6SG?th=1>> (Year: 2020).*

ETI Male Female Electric Mask Respirator, Date first available Dec. 28, 2019, amazon.com [online], [site visited Dec. 16, 2021], Available from internet, URL: <<https://www.amazon.ca/Respirator-Activated-Automatic-Purifying-Dustproof/dp/B0834X9J7P>> (Year: 2019).*

Reusable Smart Electric N95 Face Mask Q5 Pro, Jun. 15, 2020, geekbuying.com [online], [site visited Dec. 16, 2021], Available from internet, URL: <<https://www.geekbuying.com/item/Q5-Pro-Reusable-Smart-Electrical-Adult-3D-Mask-Pink-423933.html?pmrm=ems-item-similar-emspd>> (Year: 2020).*

* cited by examiner

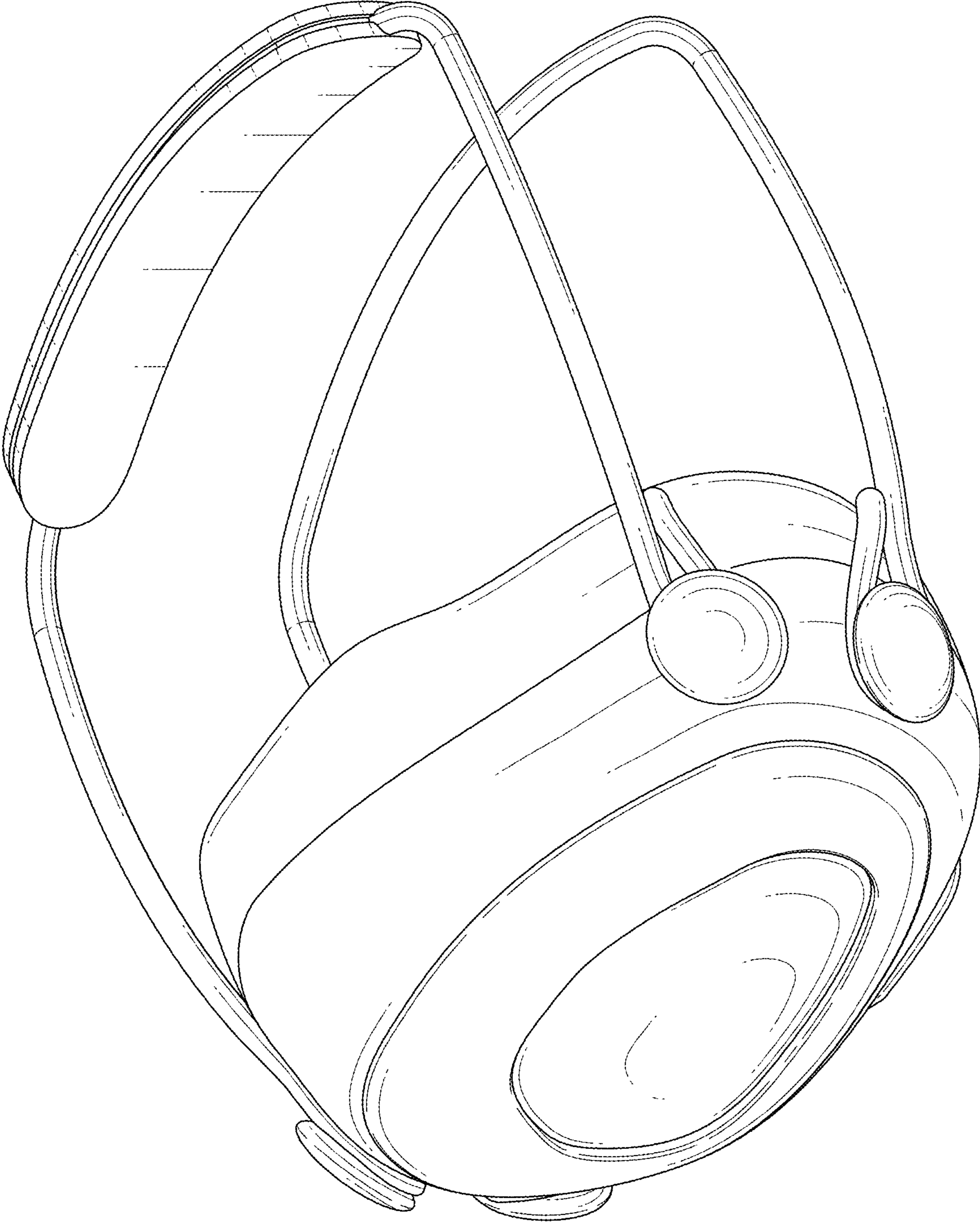

FIG. 1

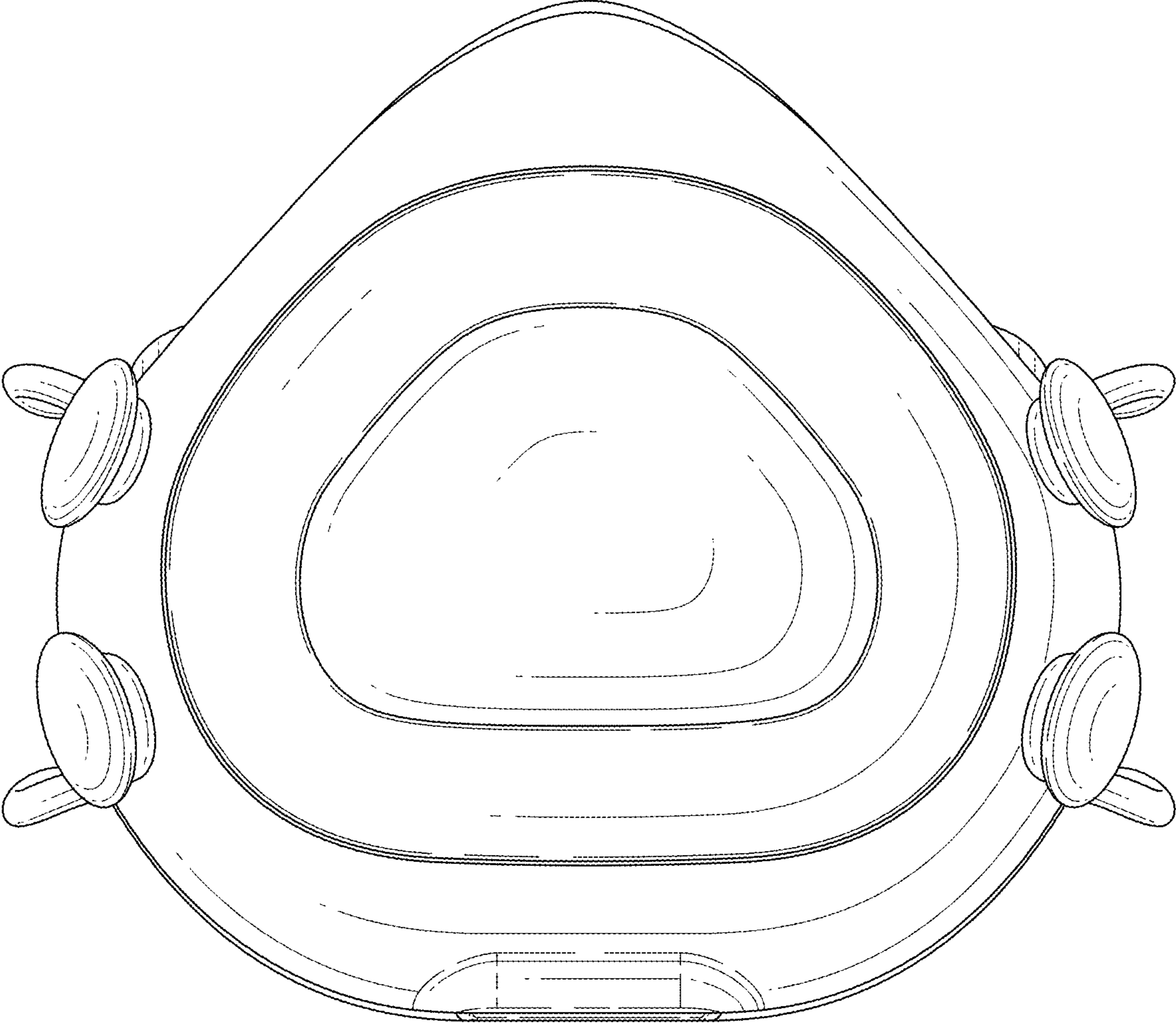

FIG. 2

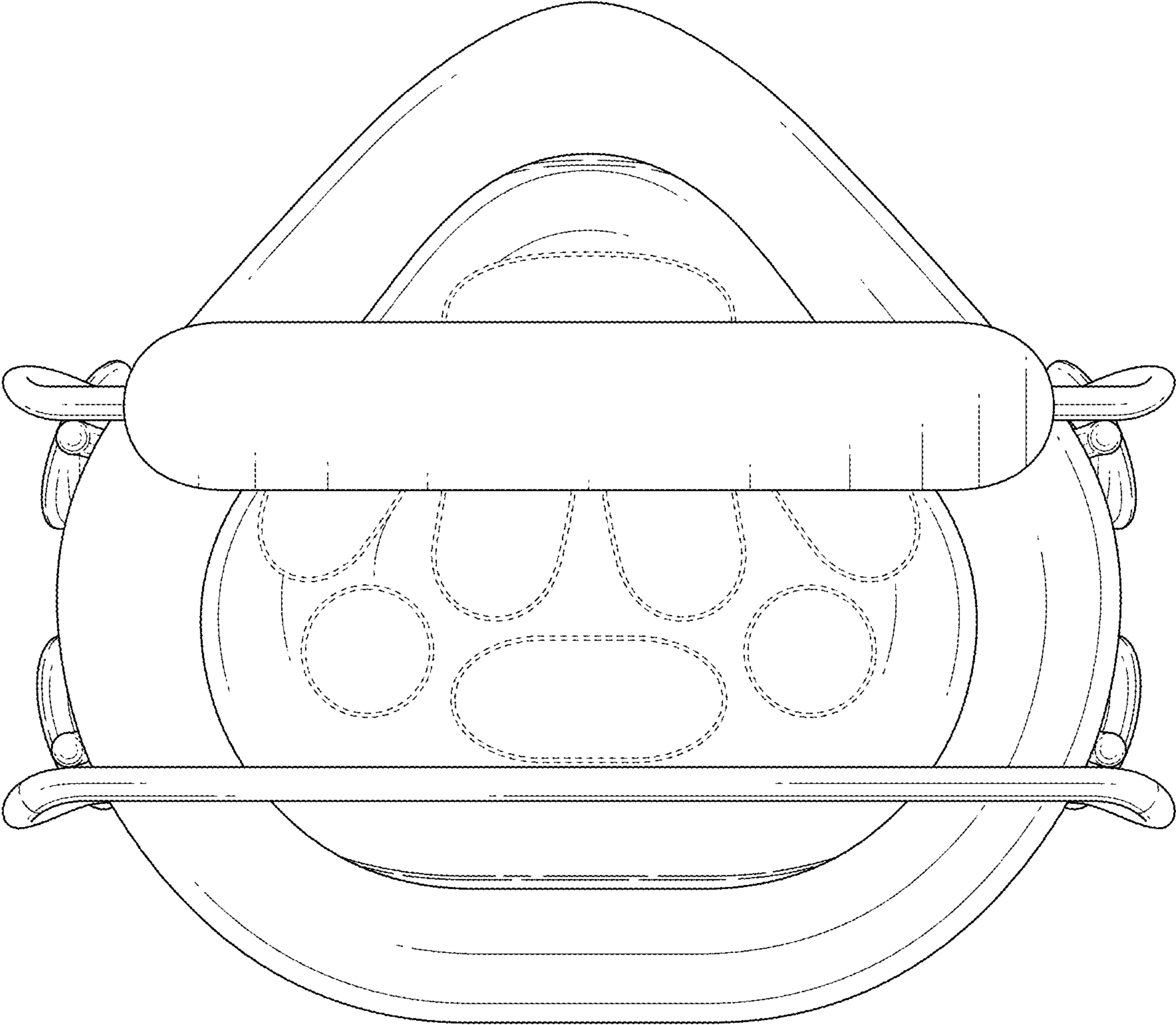

FIG. 3

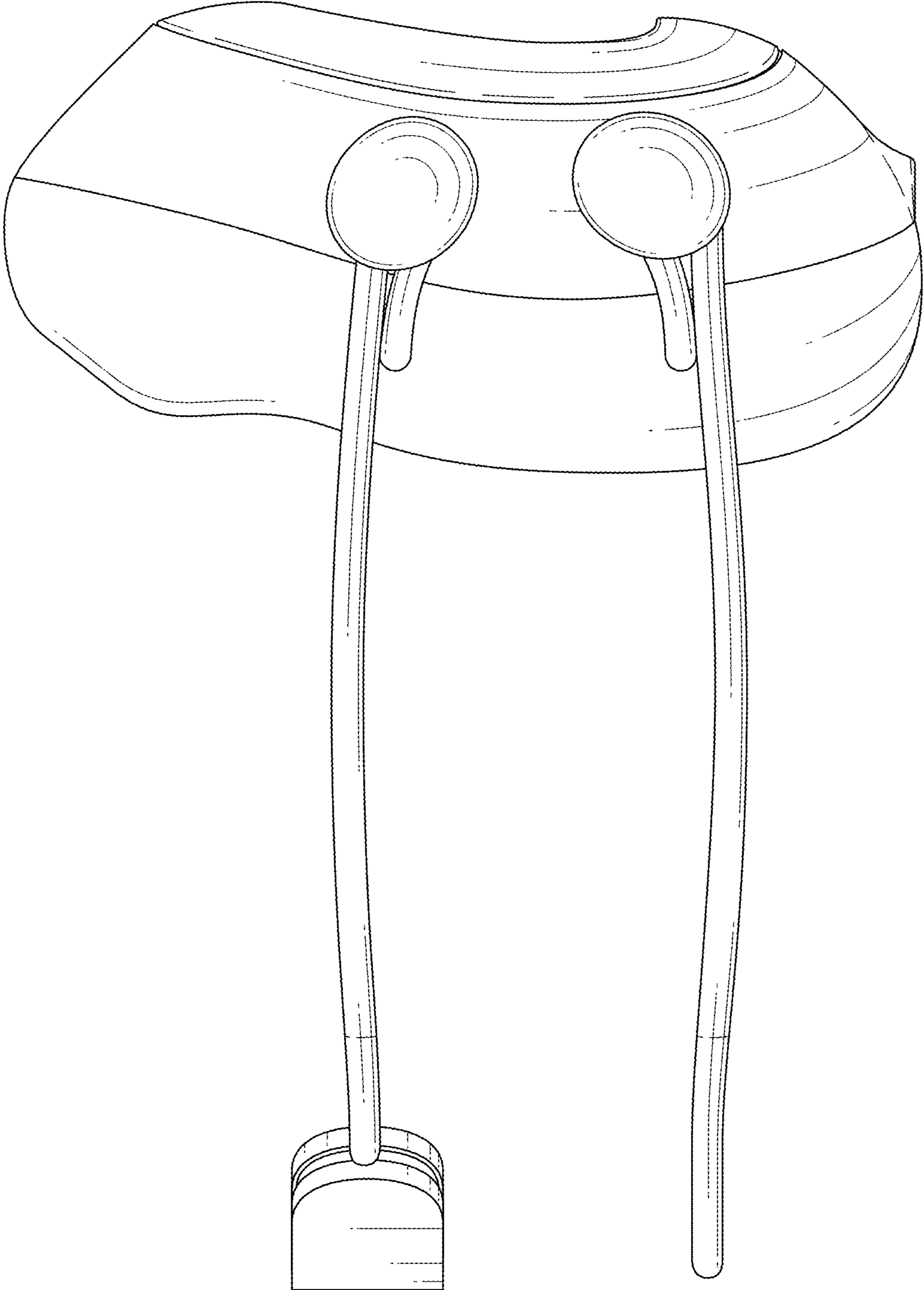

FIG. 4

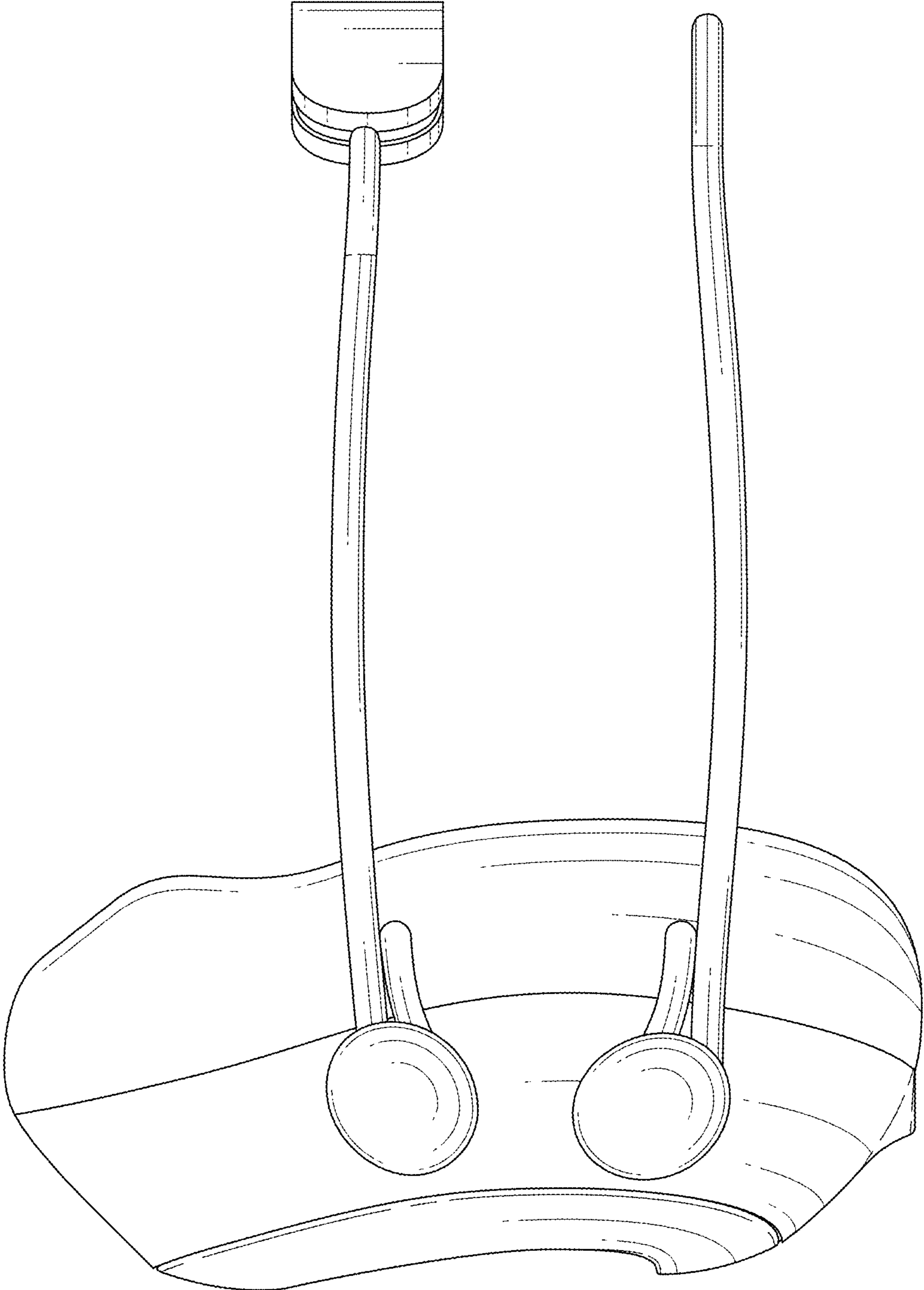

FIG. 5

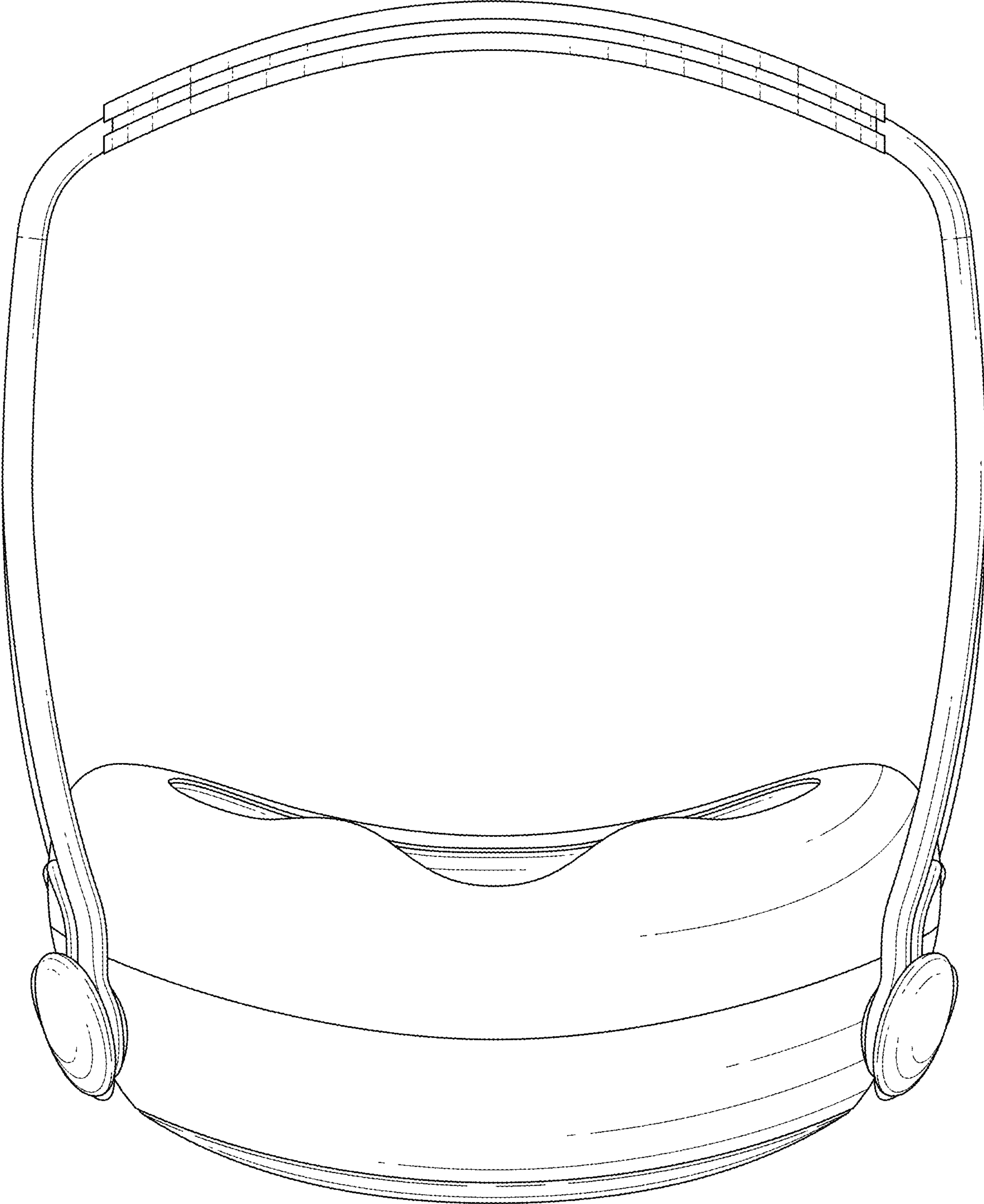

FIG. 6



FIG. 7

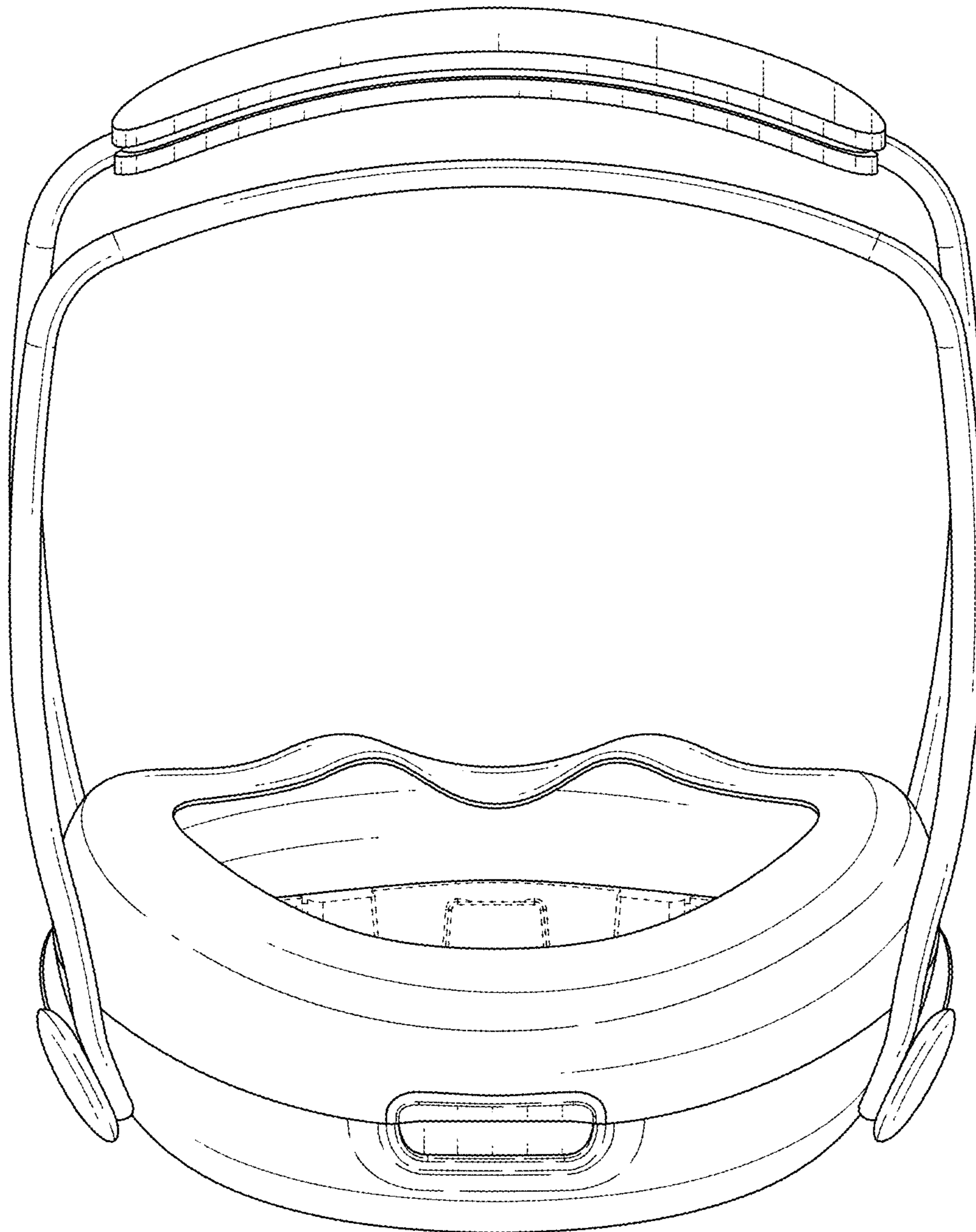

FIG. 8



FIG. 9