



US00D960351S

(12) **United States Design Patent**
Khera et al.

(10) **Patent No.:** **US D960,351 S**
(45) **Date of Patent:** **** Aug. 9, 2022**

(54) **BUCKLE FOR RESPIRATORY MASK HEADGEAR**

(71) Applicant: **ResMed Pty Ltd**, Bella Vista (AU)

(72) Inventors: **Rahul Khera**, Sydney (AU); **Damien Julian Mazzone**, Sydney (AU); **Justin John Formica**, Sydney (AU)

(73) Assignee: **ResMed Pty Ltd**, Bella Vista (AU)

(**) Term: **15 Years**

(21) Appl. No.: **29/818,122**

(22) Filed: **Dec. 7, 2021**

Related U.S. Application Data

(62) Division of application No. 29/753,275, filed on Sep. 30, 2020, now Pat. No. Des. 938,576, which is a division of application No. 29/710,893, filed on Oct. 28, 2019, now Pat. No. Des. 927,682, which is a division of application No. 29/585,443, filed on Nov. 23, 2016, now Pat. No. Des. 865,158.

(51) **LOC (13) Cl.** **29-02**

(52) **U.S. Cl.**
USPC **D24/110**; D24/128; D11/218

(58) **Field of Classification Search**
USPC D24/110–110.6, 127, 129, 128; D29/110; D11/218, 212
CPC A44B 11/2592; A44B 11/26; A44B 11/04; A44B 11/2511; A44B 11/2546; A44B 11/2565; A44B 11/258; A44B 11/28; A61M 16/0816; A41D 13/1161
See application file for complete search history.

(56) **References Cited**

U.S. PATENT DOCUMENTS

D136,414 S * 9/1943 White D11/218
D136,415 S * 9/1943 White D11/218
D136,586 S * 11/1943 White et al. D11/218

(Continued)

OTHER PUBLICATIONS

Wiscky Replacement Headgear, posted at amazon.com, earliest date available Jun. 12, 2021, [online], acquired on Mar. 17, 2022, Available on internet. url:https://www.amazon.com/Replacement-Headgear-Compatible-Included-Adjustment/dp/B08B3RJQJQ/ref=sr_1_8?keywords=resmed+headgear+clips&qid=1647371230&sr=8-8 (Year: 2021).*

(Continued)

Primary Examiner — Sheryl Lane

Assistant Examiner — Aula Soroush

(74) *Attorney, Agent, or Firm* — Nixon & Vanderhye P.C.

(57) **CLAIM**

The ornamental design for a buckle for respiratory mask headgear, as shown and described.

DESCRIPTION

FIG. 1 is a front perspective view of a buckle for respiratory mask headgear showing a first embodiment of our new design;

FIG. 2 is a front view thereof

FIG. 3 is a rear view thereof;

FIG. 4 is a top view thereof;

FIG. 5 is a bottom view thereof;

FIG. 6 is a left side view thereof;

FIG. 7 is a right side view thereof;

FIG. 8 is a reverse perspective view thereof;

FIG. 9 is a front perspective view of a buckle for respiratory mask headgear showing a second embodiment of our new design;

FIG. 10 is a front view thereof;

FIG. 11 is a rear view thereof;

FIG. 12 is a top view thereof;

FIG. 13 is a bottom view thereof;

FIG. 14 is a left side view thereof;

FIG. 15 is a right side view thereof; and,

FIG. 16 is a reverse perspective view thereof.

1 Claim, 6 Drawing Sheets

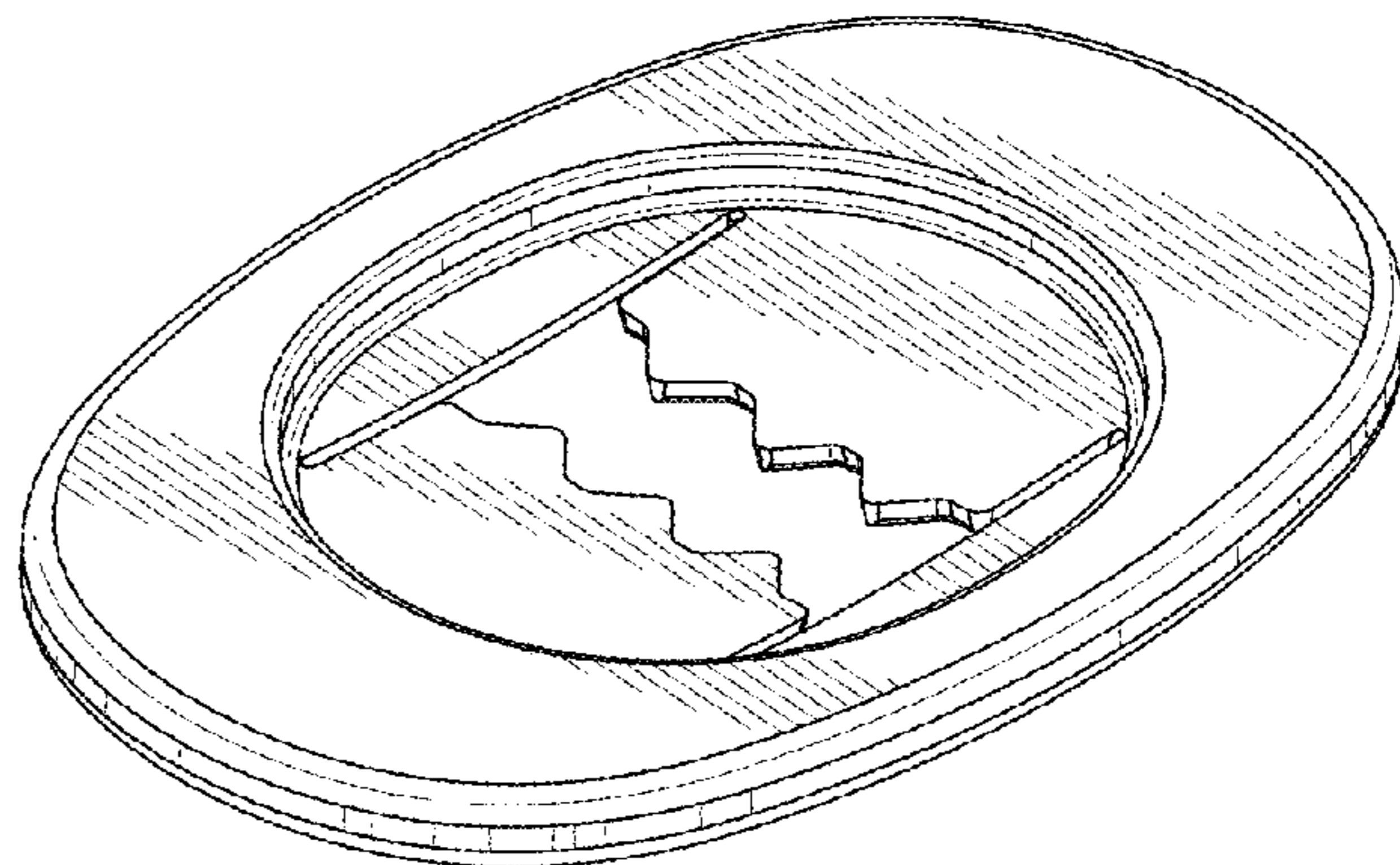
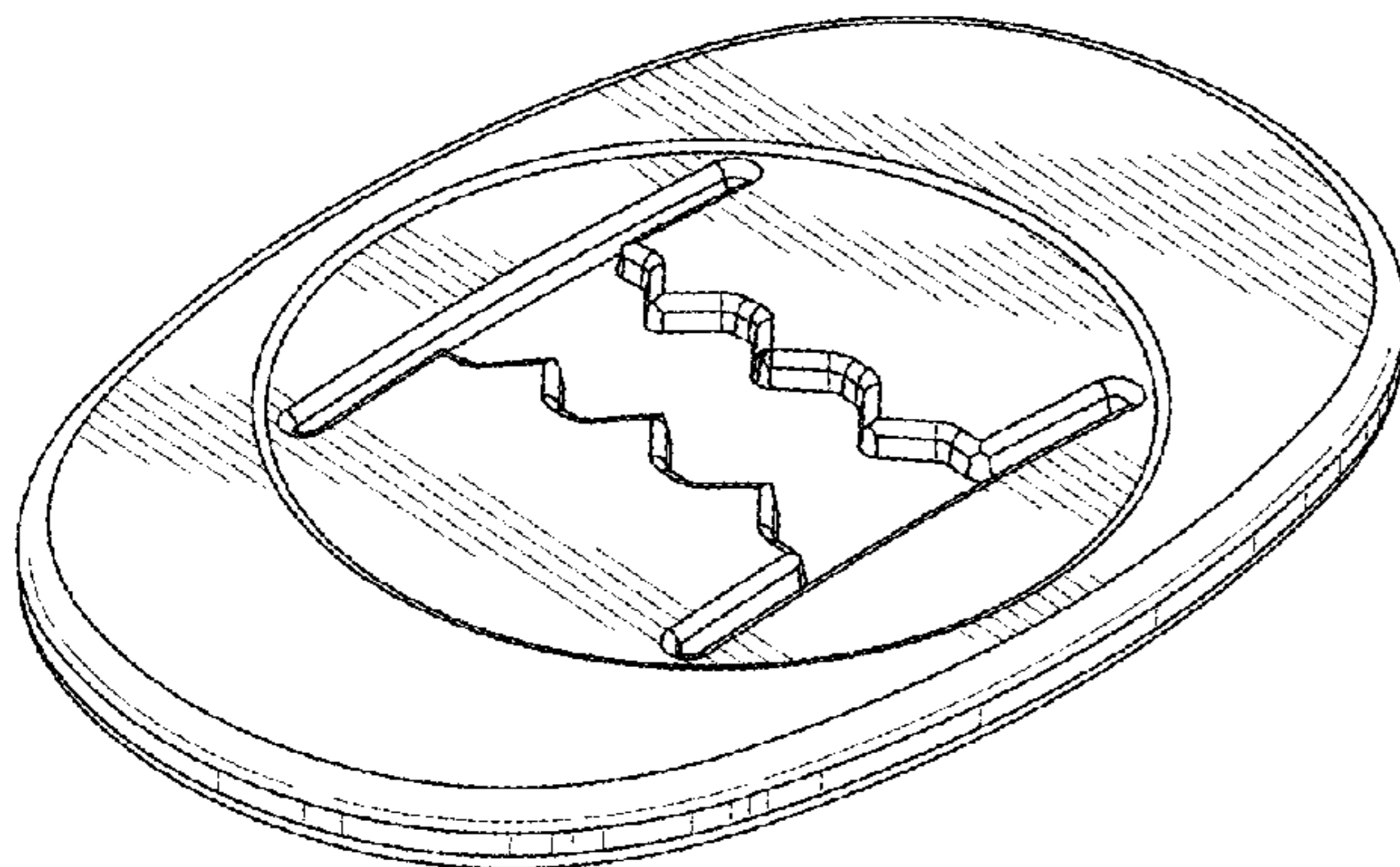

(56)

References Cited

U.S. PATENT DOCUMENTS

D136,587 S * 11/1943 White et al. D11/218
 D136,588 S * 11/1943 White et al. D11/218
 D136,589 S * 11/1943 White et al. D11/218
 D485,905 S 1/2004 Moore
 D568,787 S * 5/2008 Yang D11/218
 D586,907 S 2/2009 Judson
 D623,288 S 9/2010 Lubke
 D628,515 S * 12/2010 Schiebl D11/218
 D656,231 S 3/2012 Henry
 D659,237 S 5/2012 Lubke
 D664,250 S 7/2012 Scheiner
 D691,712 S 10/2013 Judson
 D692,554 S 10/2013 Siew
 8,573,201 B2 11/2013 Rummery
 D704,329 S 5/2014 Collazo
 D708,736 S 7/2014 Judson
 D737,953 S 9/2015 Wells
 D740,935 S 10/2015 Cullen
 D743,535 S 11/2015 Wells
 D751,687 S 3/2016 Daly
 D757,252 S 5/2016 Von Moger
 D764,049 S 8/2016 Cullen
 D770,036 S 10/2016 Walls
 D787,661 S 5/2017 Edwards
 D787,662 S 5/2017 Guney
 D794,772 S 8/2017 Cullen
 D805,630 S 12/2017 Formica
 D808,516 S 1/2018 Edwards
 D817,809 S * 5/2018 Dumas A44B 11/00
 D821,259 S * 6/2018 Ciptak D11/218
 D865,158 S 10/2019 Khera et al.
 D899,966 S * 10/2020 Spater D11/218
 D920,159 S * 5/2021 Power, II D11/218
 D927,682 S 8/2021 Khera et al.
 11,154,680 B2 * 10/2021 Walls A61M 16/0683
 2007/0181130 A1 8/2007 Worley
 2010/0116272 A1 5/2010 Row

2010/0313891 A1 12/2010 Veliss
 2011/0146685 A1 6/2011 Allan
 2012/0067349 A1 3/2012 Barlow
 2012/0090622 A1 4/2012 Chang
 2012/0227738 A1 9/2012 Virr
 2014/0000614 A1 1/2014 Chang
 2014/0283843 A1 9/2014 Eves
 2015/0151071 A1 6/2015 Von Moger
 2016/0051784 A1 2/2016 Eury
 2016/0074614 A1 3/2016 Huddart
 2016/0082217 A1 3/2016 McLaren
 2016/0151596 A1 6/2016 Slight
 2016/0213878 A1 7/2016 Browning, Jr.
 2016/0287830 A1 10/2016 Walls
 2017/0000964 A1 1/2017 Shafer
 2017/0100556 A1 4/2017 Munkelt
 2017/0368285 A1 12/2017 Wood
 2018/0001044 A1 1/2018 Stephens

OTHER PUBLICATIONS

Impresa 2-Pack Replacement Headgear, posted at amazon.com, earliest date available Nov. 6, 2018, [online], acquired on Mar. 17, 2022, Available on internet. url:https://www.amazon.com/Impresa-Pillow-Replacement-Headgear-Compatible/dp/B07K7Y62BR/ref=cm_cr_ar_p_d_product_top?ie=UTF8 (Year: 2018).*

Medihealer 3 Pack Replacement Headgear, posted at amazon.com, earliest date available Sep. 28, 2018, [online], acquired on Mar. 17, 2022, Available on internet. url:https://www.amazon.com/Replacement-Headgear-Compatible-Resmed-Airfit/dp/B07HSV8CXC/ref=cm_cr_ar_p_d_product_top?ie=UTF8 (Year: 2018).*

KaryHome Store Resmed Airfit P10 Headgear, posted at amazon.com, earliest date available Oct. 7, 2021, [online], acquired on Mar. 17, 2022, Available on internet. url:https://www.amazon.com/Headgear-KaryHome-Replacement-Compatible-Adjustment/dp/B09HX3Q67X/ref=cm_cr_ar_p_d_product_top?ie=UTF8 (Year: 2021).*

U.S. Appl. No. 29/753,275, filed Sep. 30, 2020, of Rahul Khera et al., for "Respiratory Mask Components," (parent application).

* cited by examiner

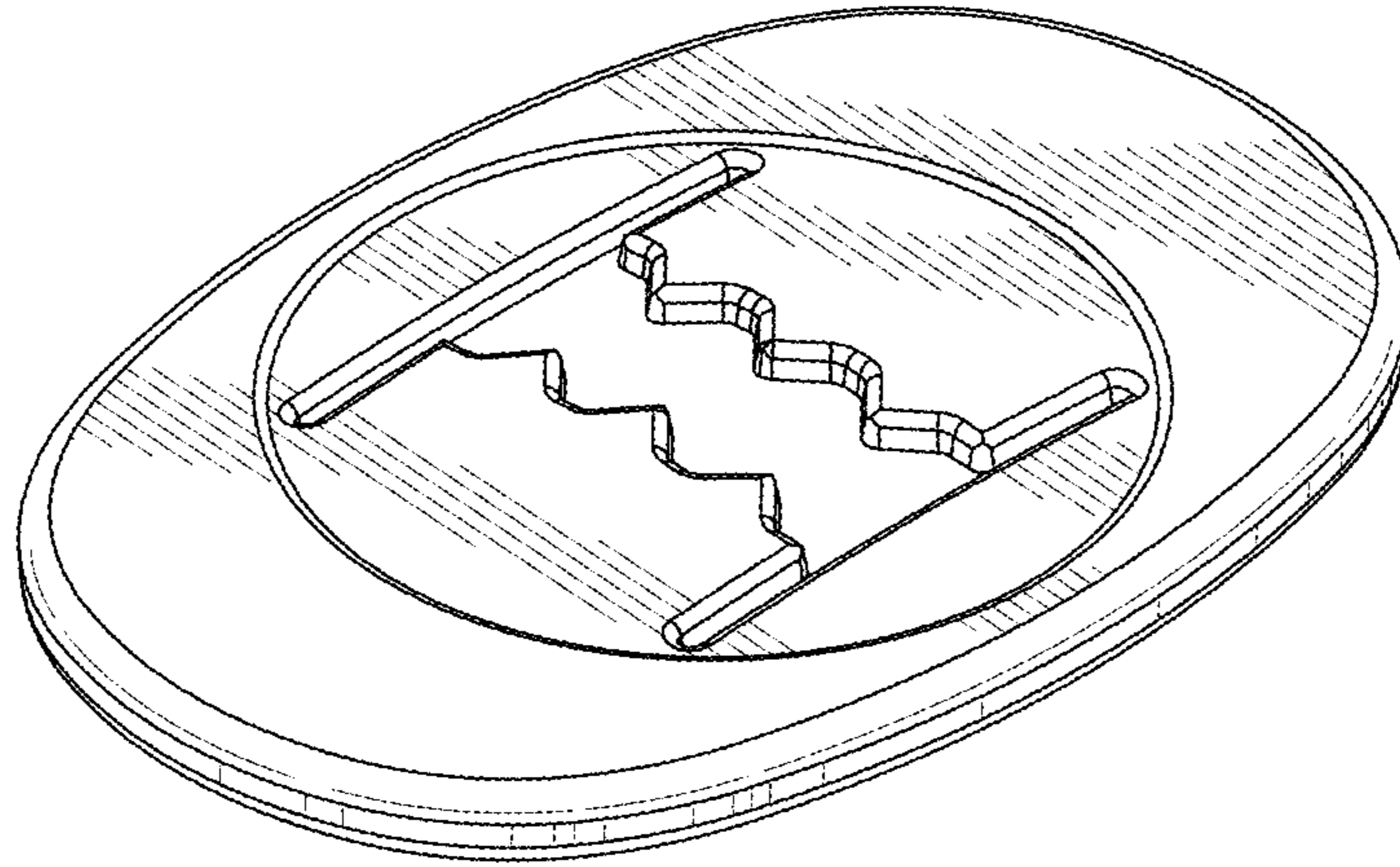

FIG. 1

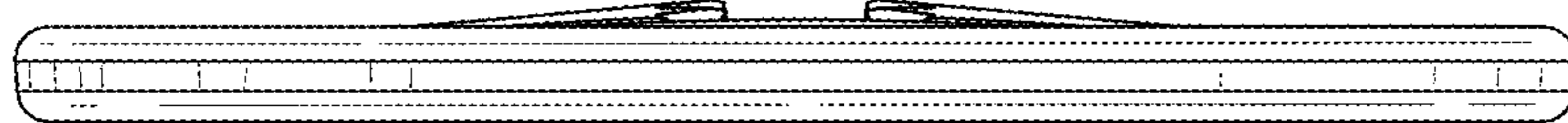

FIG. 2

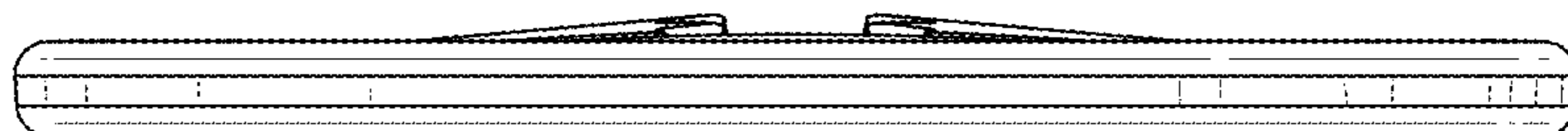

FIG. 3

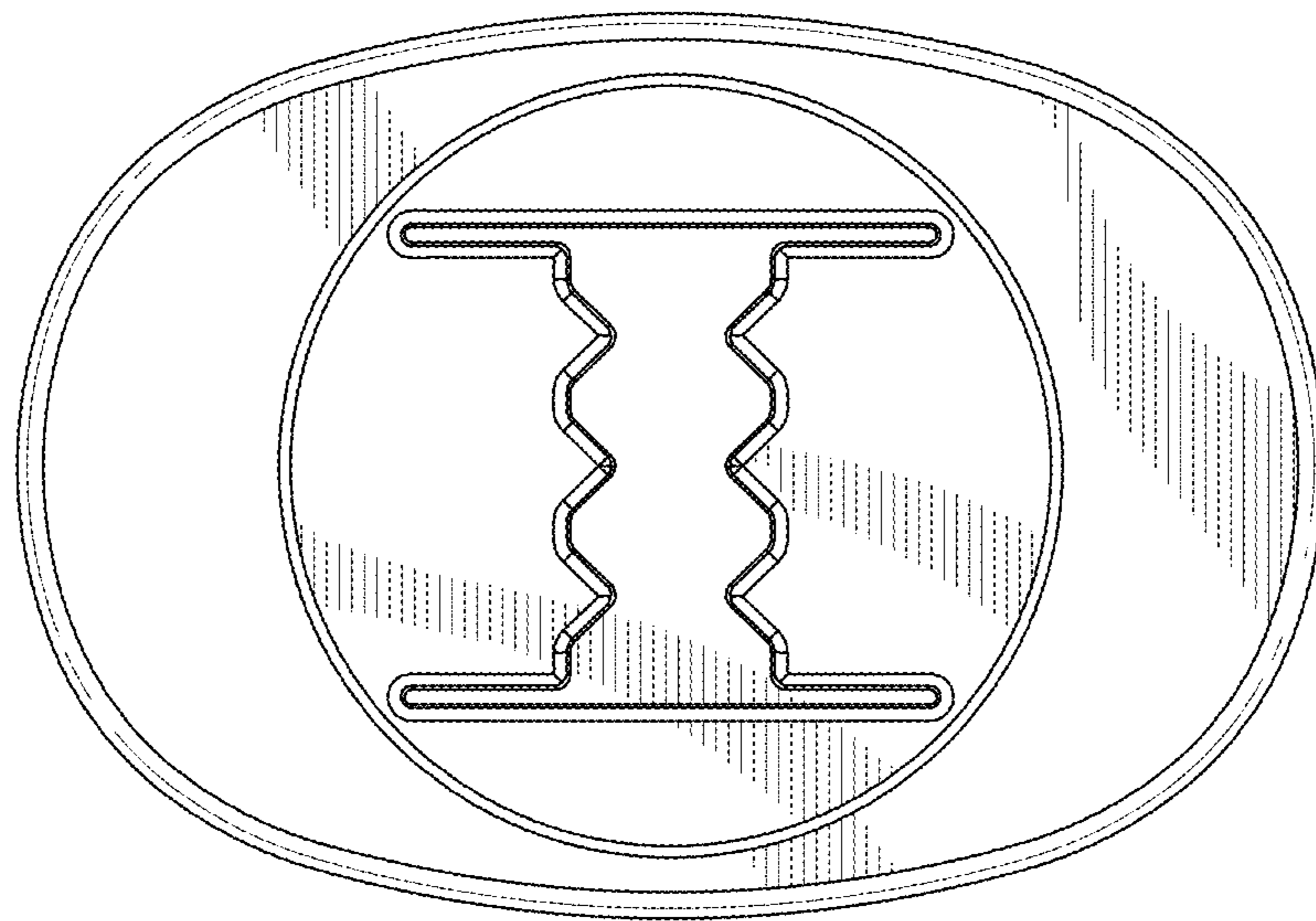

FIG. 4

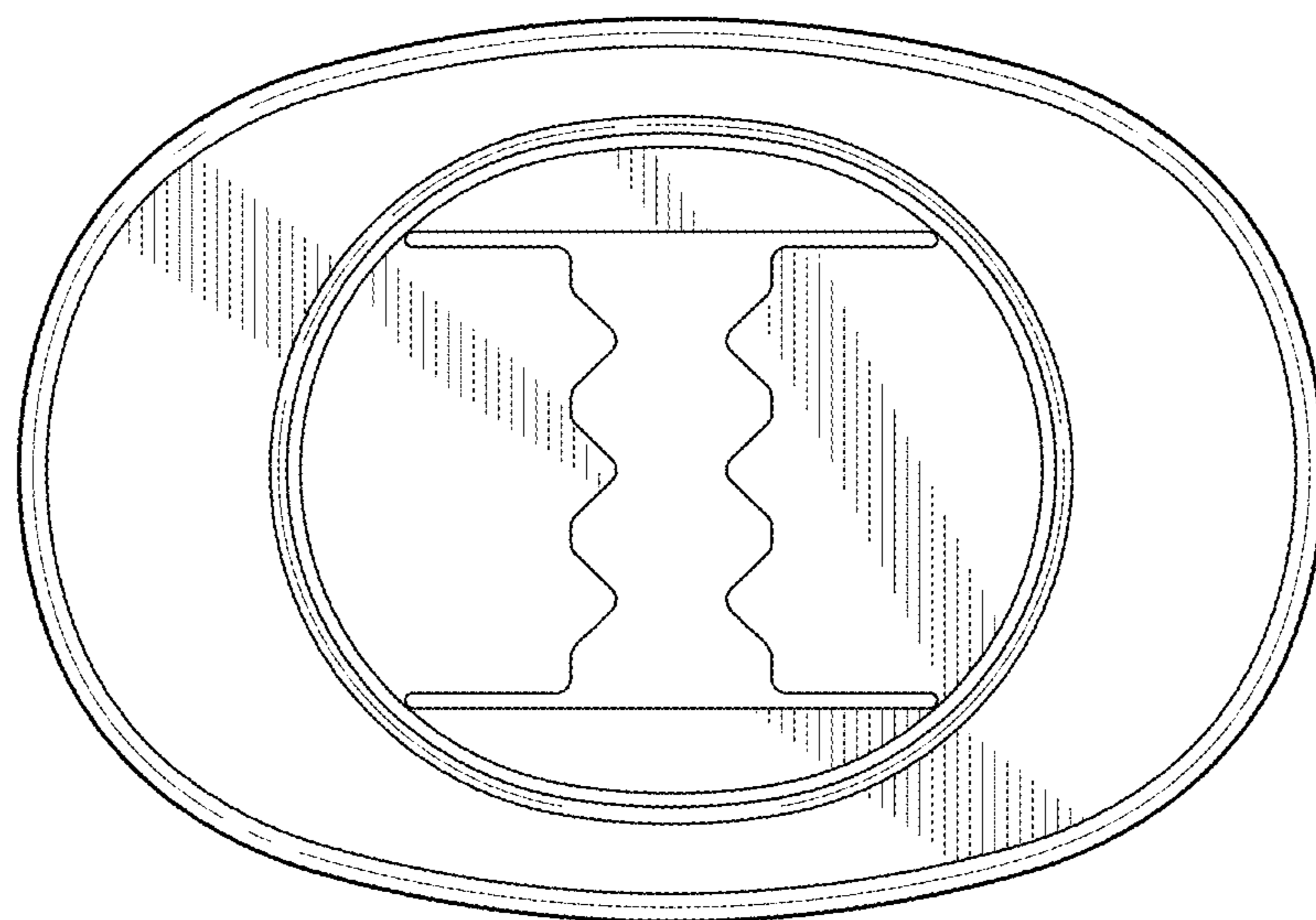

FIG. 5

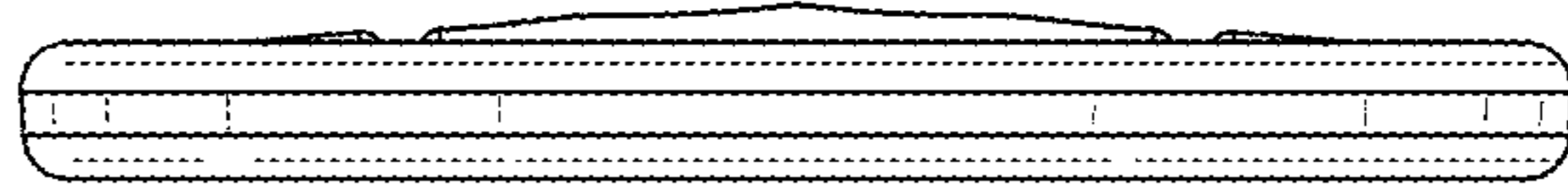

FIG. 6

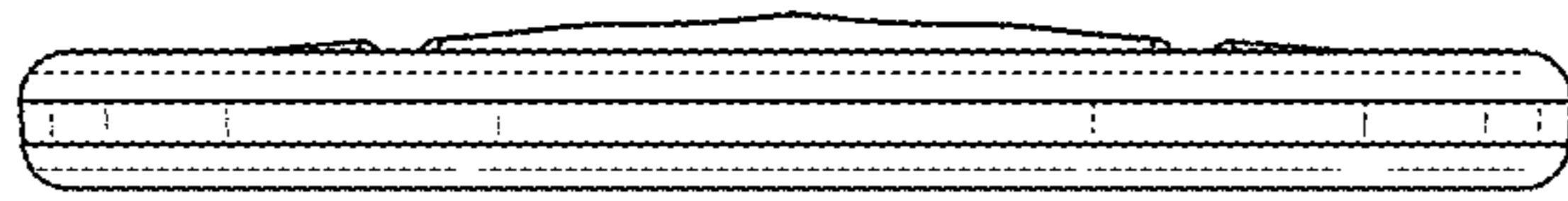

FIG. 7

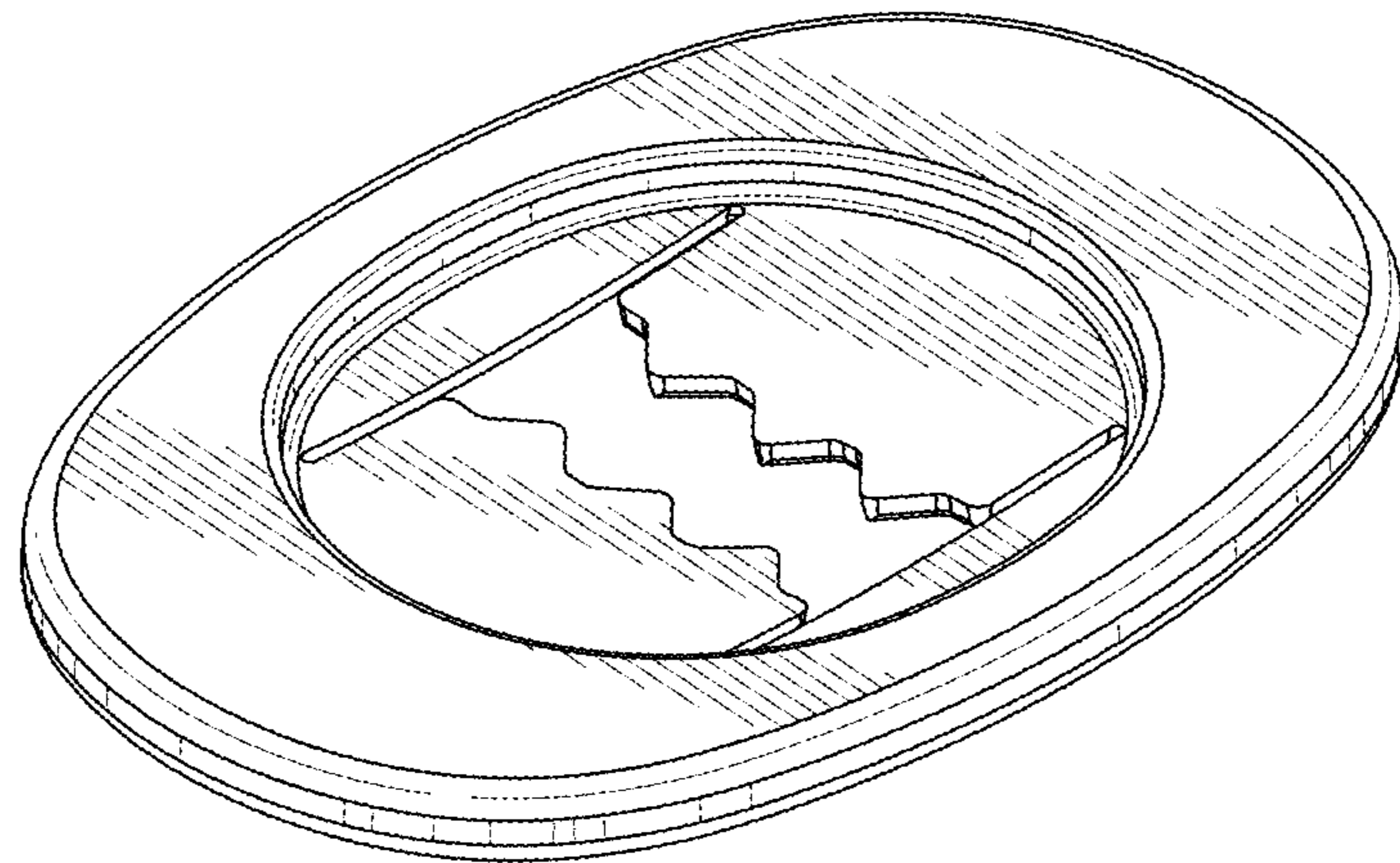

FIG. 8

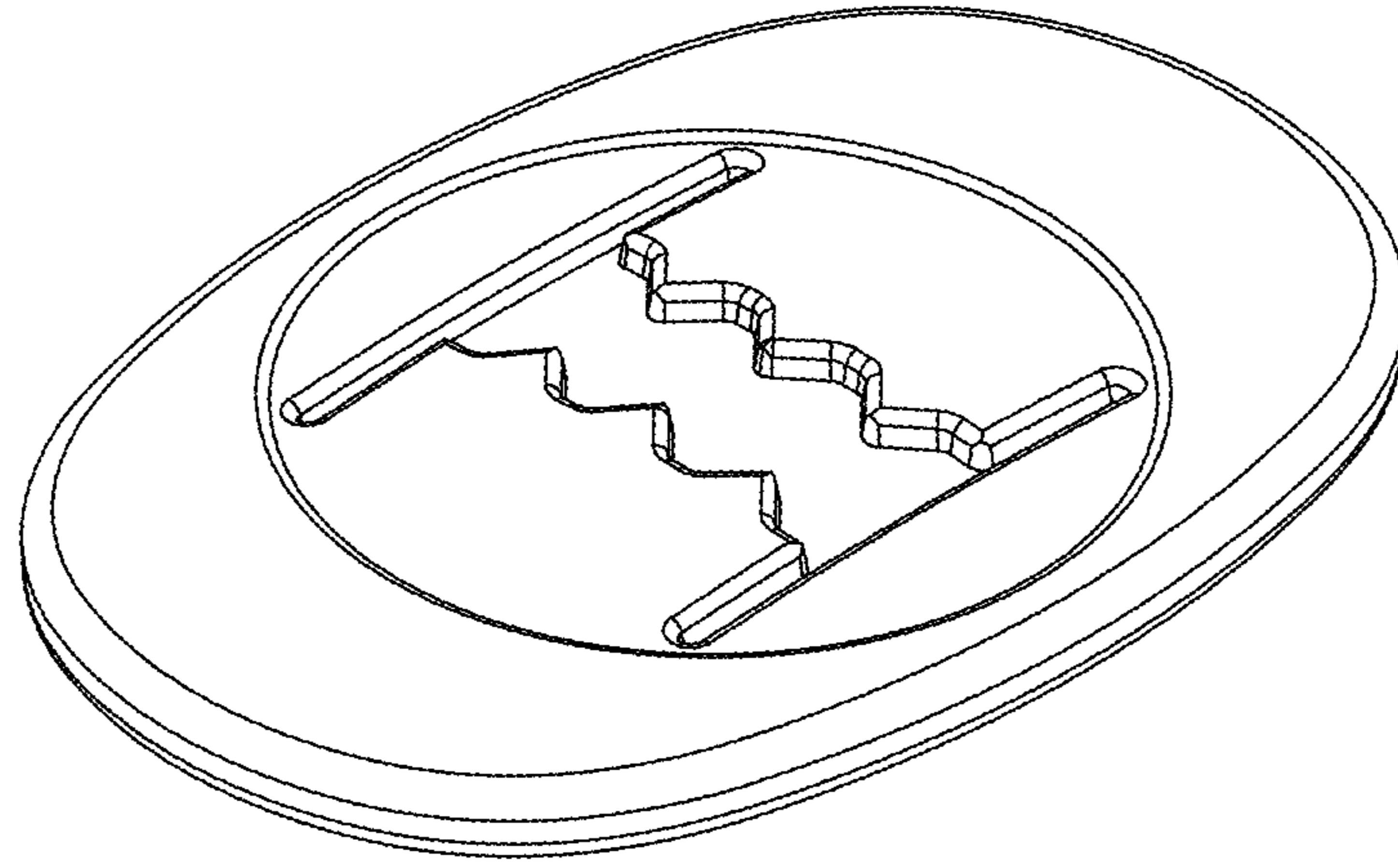

FIG. 9

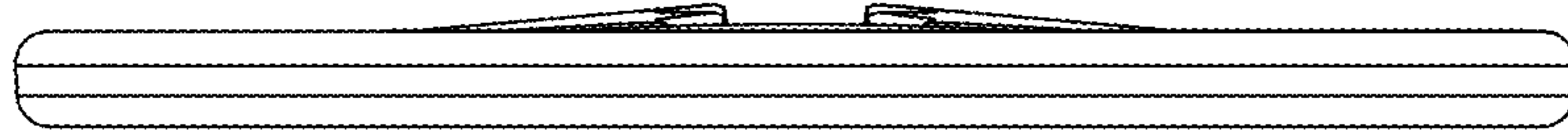

FIG. 10

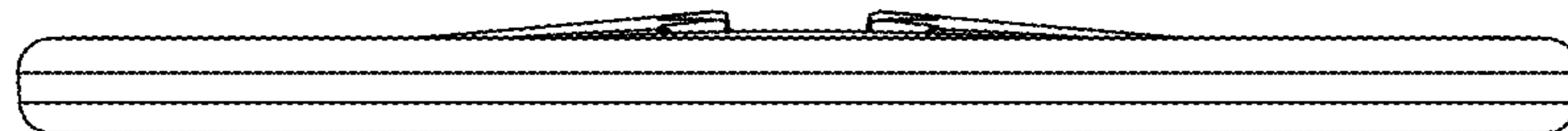

FIG. 11

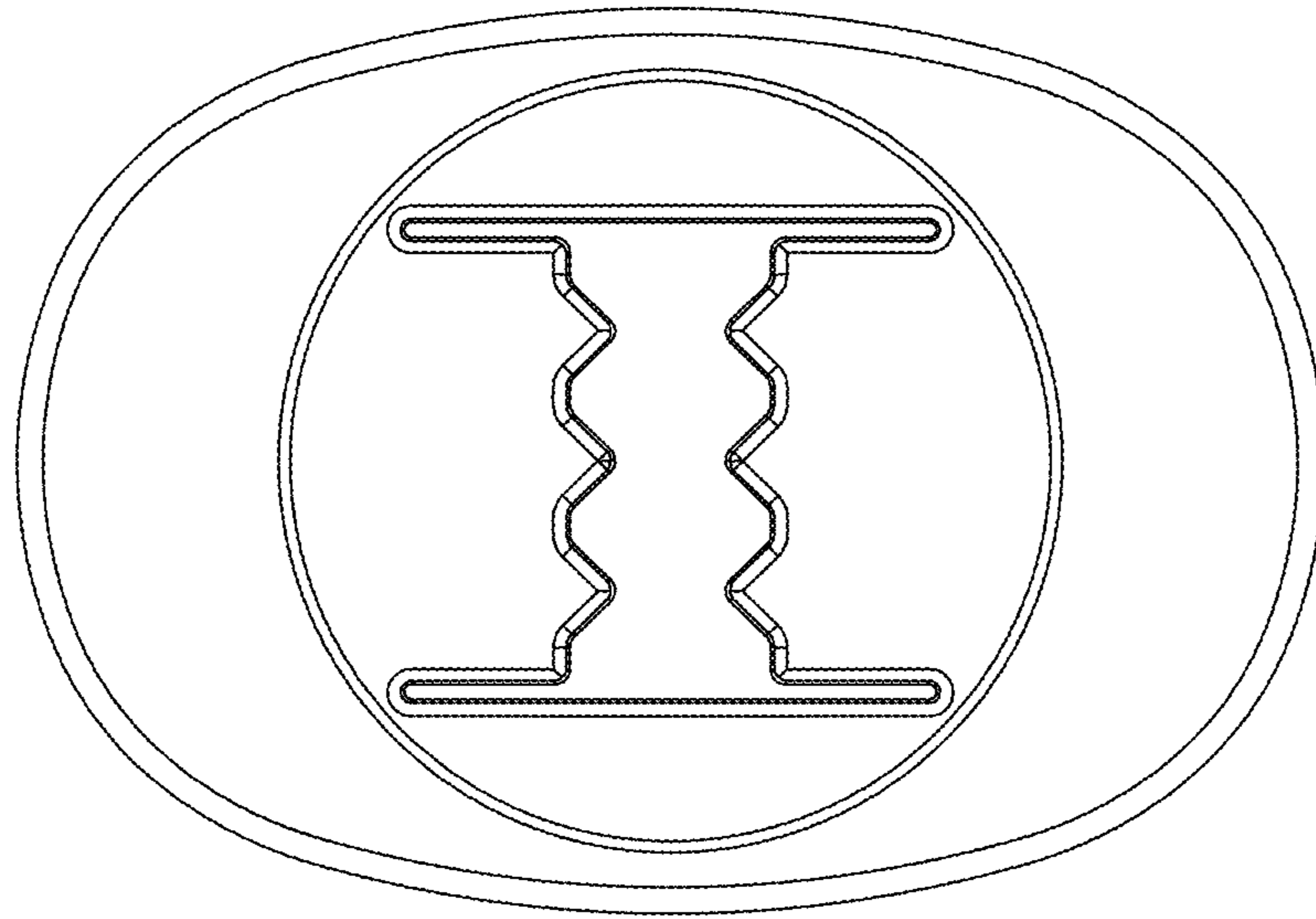

FIG. 12

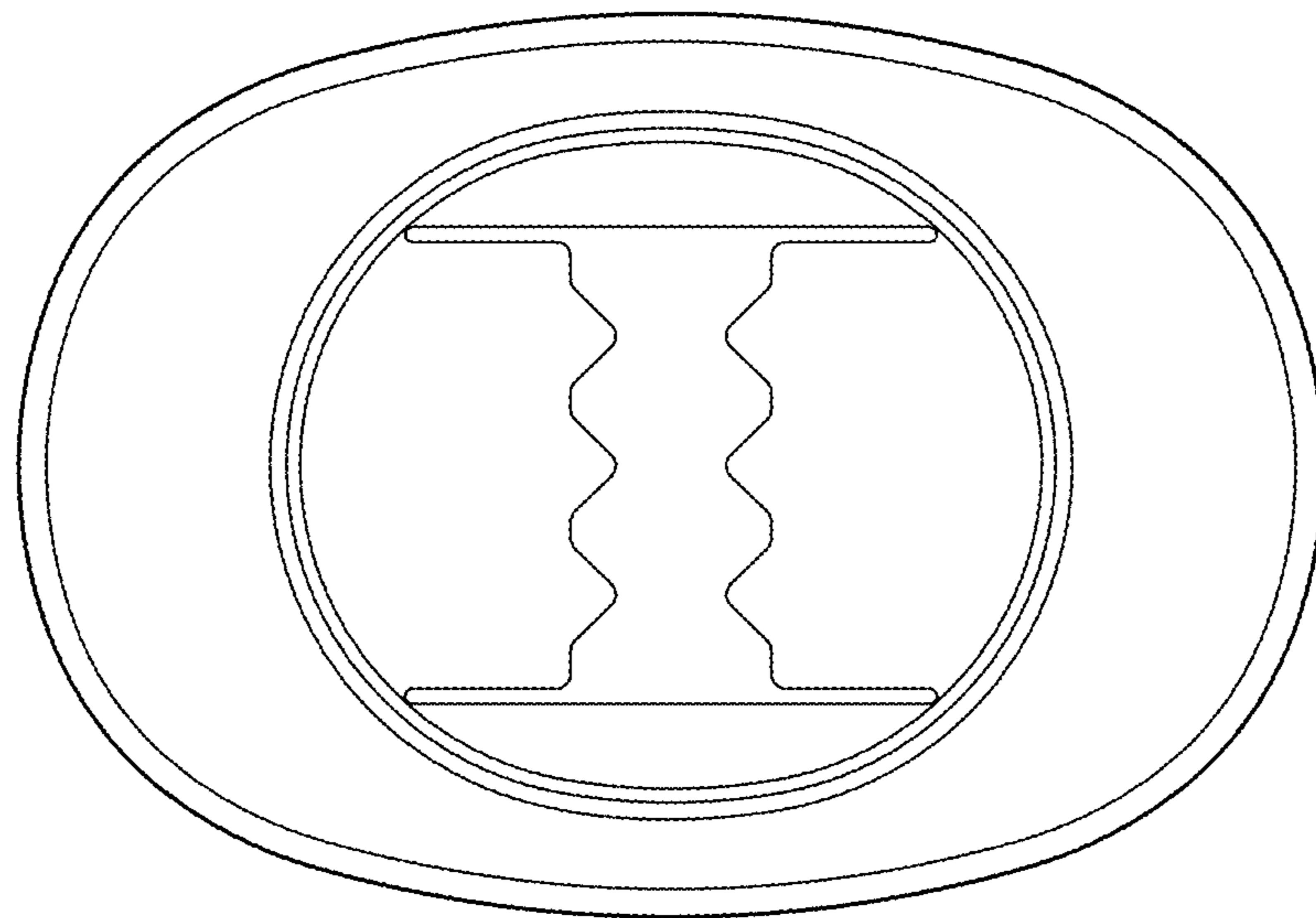

FIG. 13



FIG. 14

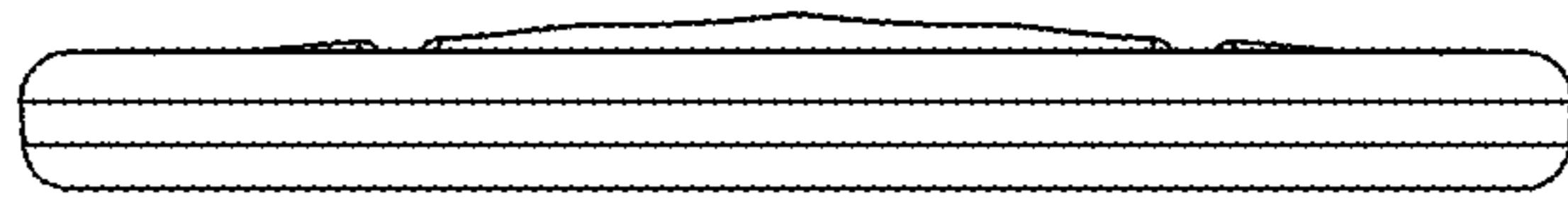

FIG. 15

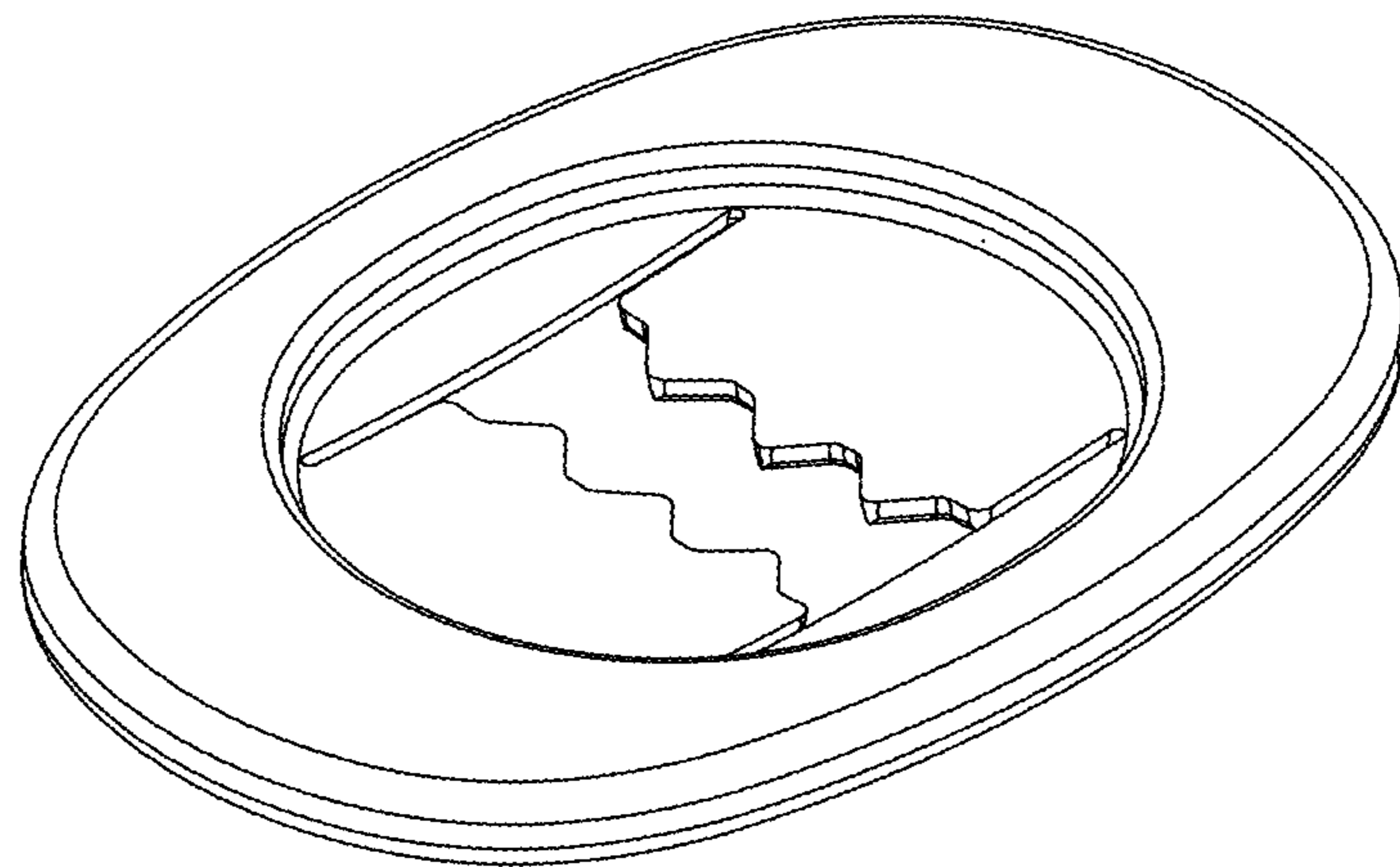

FIG. 16