

US00D960337S

(12) **United States Design Patent** (10) **Patent No.:** **US D960,337 S**
Sun (45) **Date of Patent:** **** Aug. 9, 2022**

(54) **HUMIDIFIER**

(71) Applicant: **Chunmei Sun**, Zhongshan (CN)

(72) Inventor: **Chunmei Sun**, Zhongshan (CN)

(**) Term: **15 Years**

(21) Appl. No.: **29/745,107**

(22) Filed: **Aug. 4, 2020**

(30) **Foreign Application Priority Data**

Apr. 23, 2020 (CN) 202030170867.8

(51) **LOC (13) Cl.** **23-04**

(52) **U.S. Cl.**
USPC **D23/356**

(58) **Field of Classification Search**
USPC D23/356, 359, 364-365, 378, 499
CPC F24F 3/16; F24F 3/1405; F24F 3/1603;
F24F 13/20; F24F 13/222
See application file for complete search history.

(56) **References Cited**

U.S. PATENT DOCUMENTS

D650,473 S	*	12/2011	Petersen	D23/364
D773,027 S	*	11/2016	Hu	D23/365
D801,503 S	*	10/2017	Reed	D23/356
D891,600 S	*	7/2020	Kim	D23/364
D893,693 S	*	8/2020	Xiao	D23/356
D898,175 S	*	10/2020	Liu	D23/356
D903,844 S	*	12/2020	Chen	D23/356
D935,585 S	*	11/2021	Tokoi	D23/356

FOREIGN PATENT DOCUMENTS

CN	302416670	*	11/2012
CN	306113495	*	4/2020
GB	6090029	*	5/2020

OTHER PUBLICATIONS

GENIANI Top Fill Cool Mist Humidifiers, first available Jul. 30, 2019[online], [site visited Nov. 15, 2021]. Available from internet, URL:<https://www.amazon.com/GENIANI-Humidifiers-Bedroom-Essential-Diffuser/dp/B07VWBDKWS> (Year: 2019).*
BlueHills Premium 3000 ML XL Essential Oil Diffuser Aroma Humidifier, first available Sep. 2, 2018[online], [site visited Nov. 17, 2021]. Available from internet, URL:<https://www.amazon.com/BlueHills-Essential-Diffuser-Humidifier-Capacity/dp/B08B4Y8M6K> (Year: 2017).*

* cited by examiner

Primary Examiner — Barbara Fox

Assistant Examiner — Jamaal Rasheed

(57) **CLAIM**

The ornamental design for a humidifier, as shown and described.

DESCRIPTION

FIG. 1 is a perspective view of a humidifier showing my new design;
FIG. 2 is a front view thereof;
FIG. 3 is a back view thereof;
FIG. 4 is a right side view thereof;
FIG. 5 is a left side view thereof;
FIG. 6 is a top view thereof; and,
FIG. 7 is a bottom view thereof.
The broken lines shown in the drawings depict portions of the humidifier in which the design is embodied that form no part of the claimed design.

1 Claim, 7 Drawing Sheets

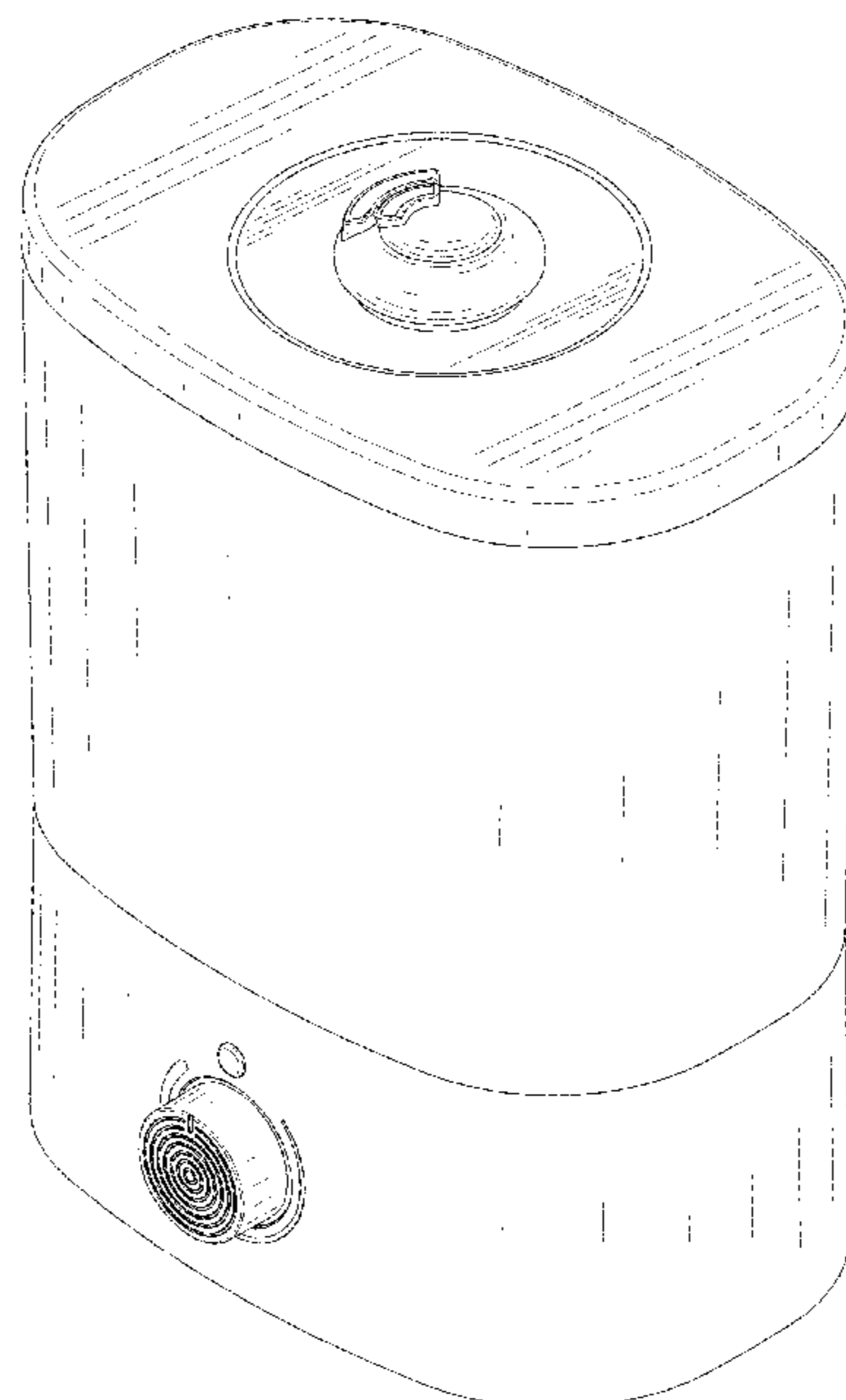

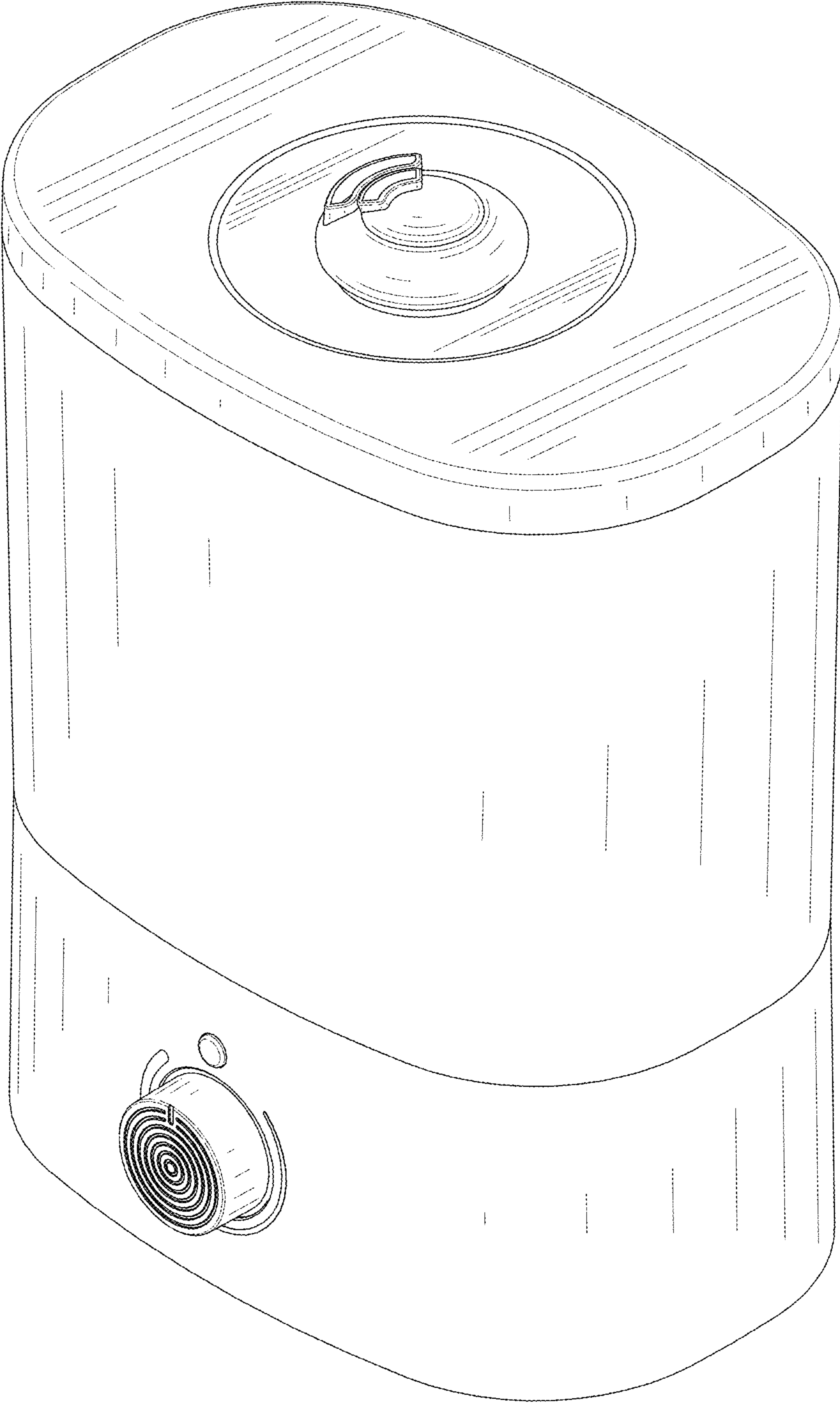

FIG. 1

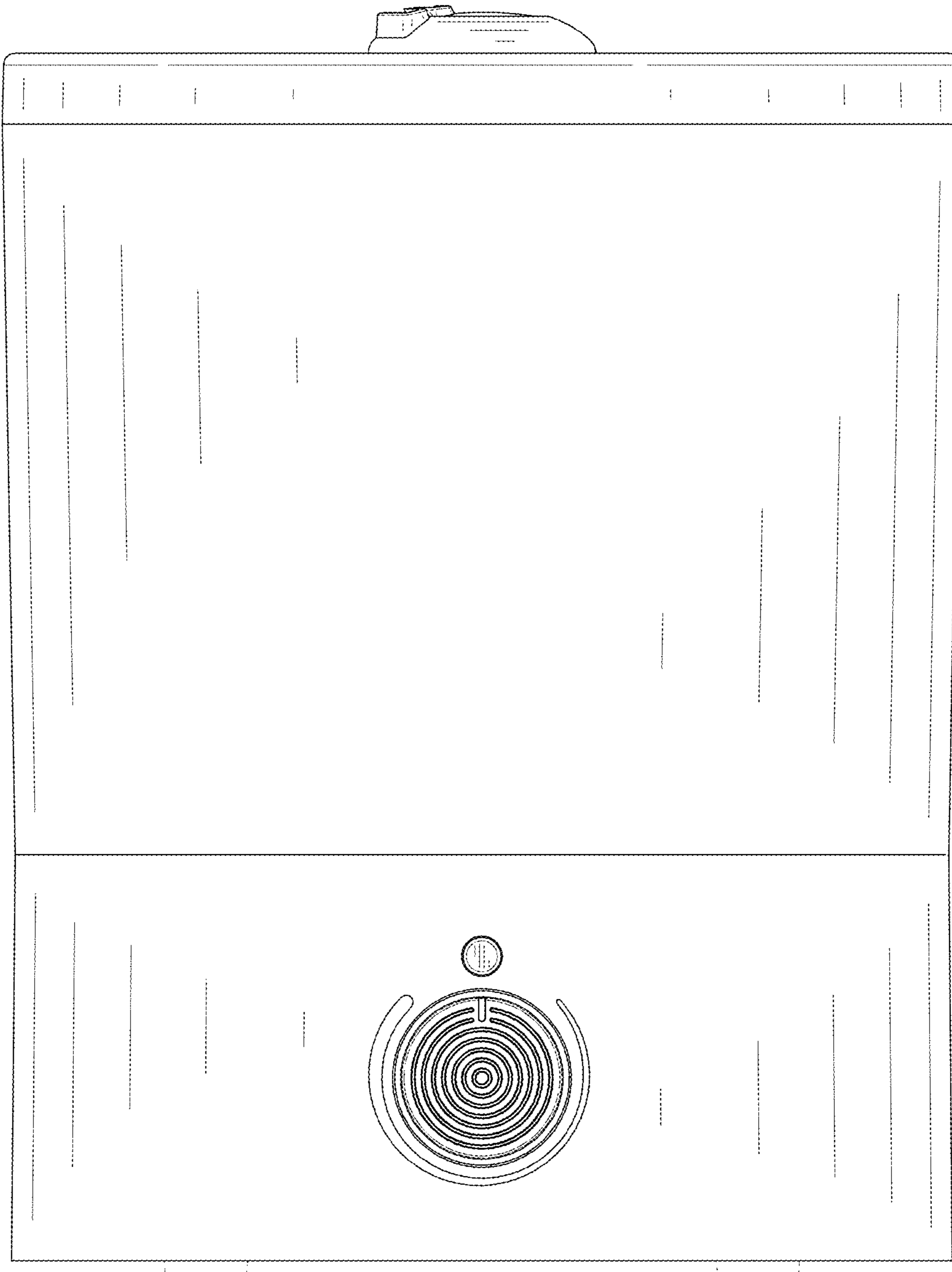

FIG. 2

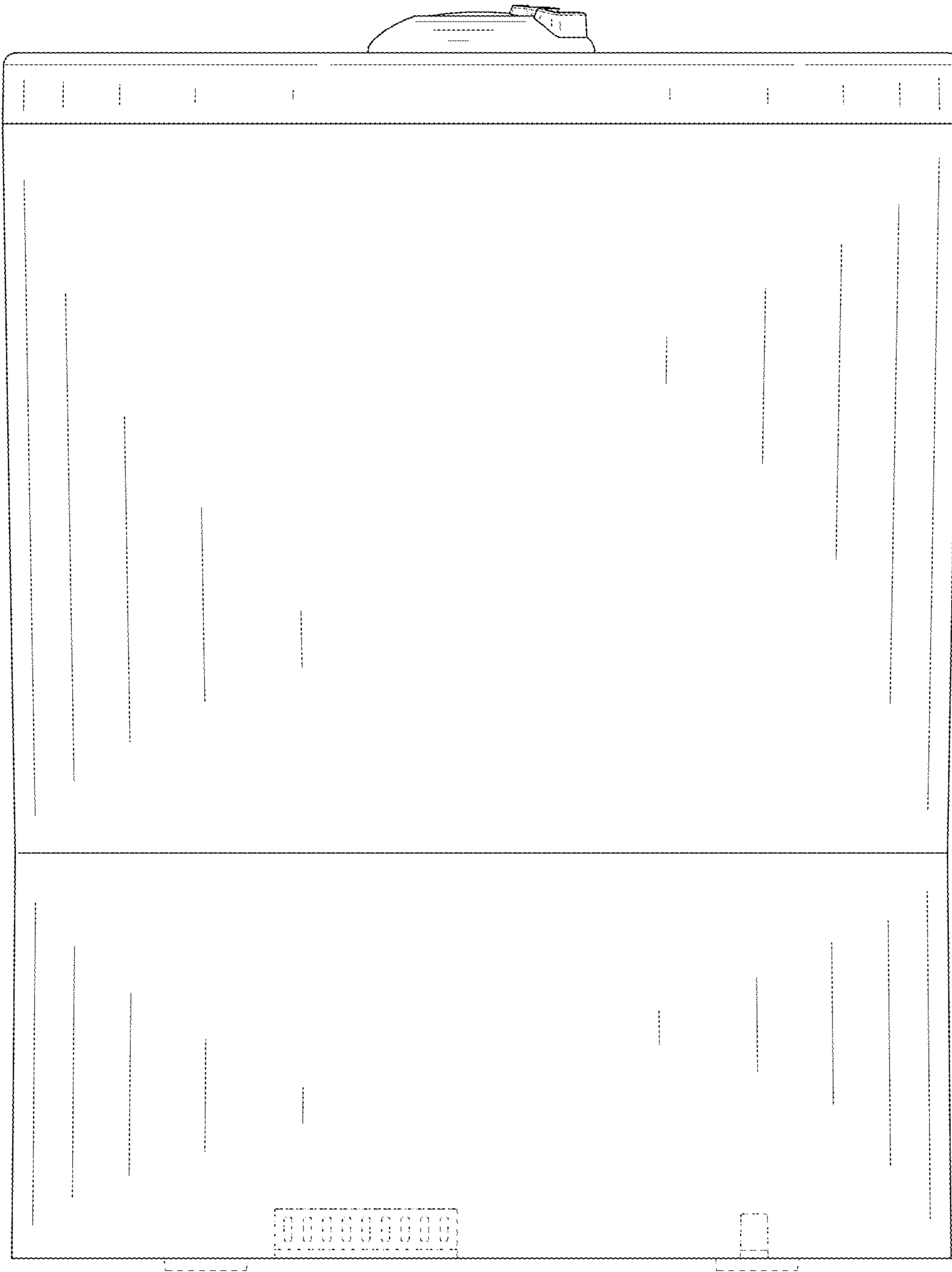

FIG. 3

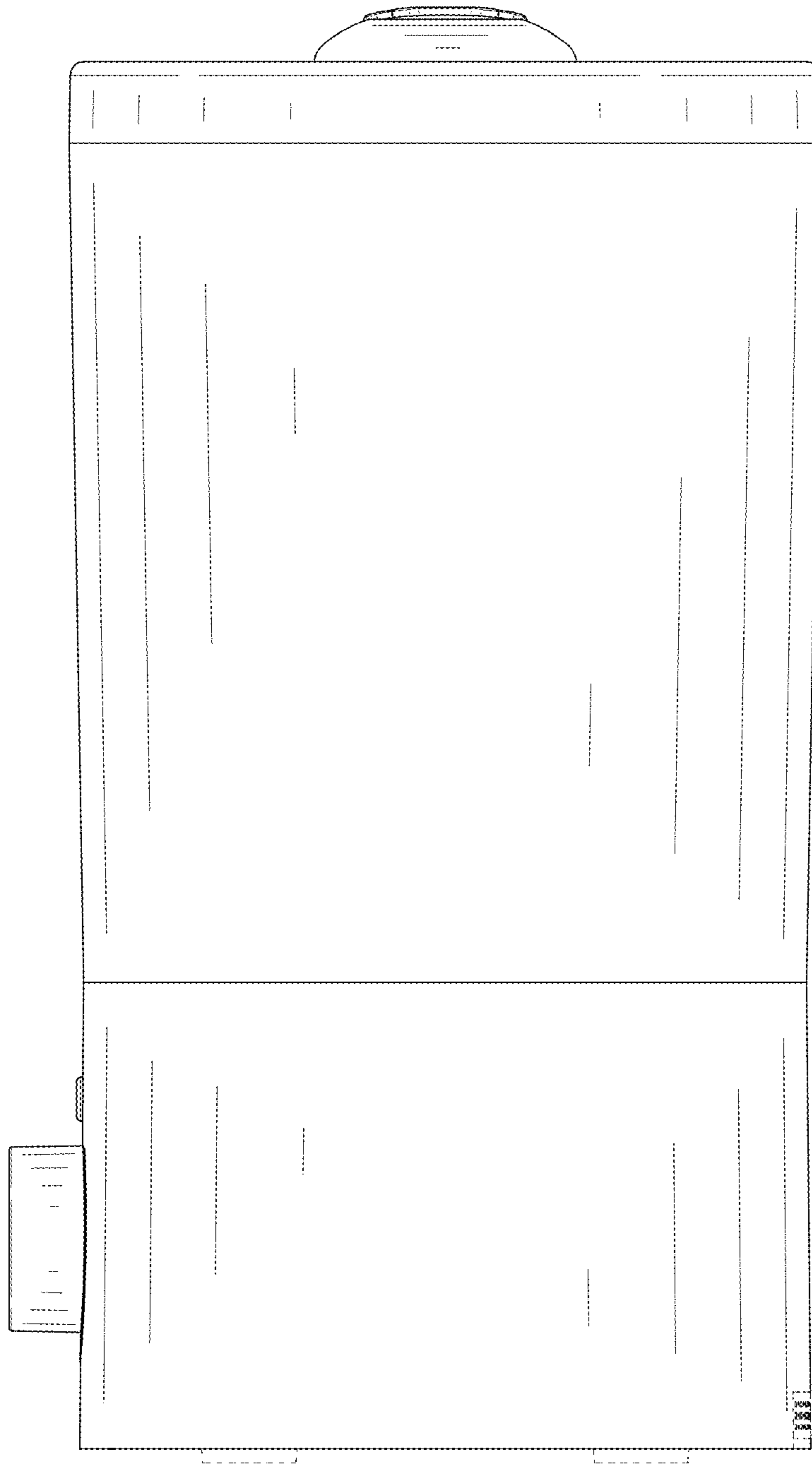

FIG. 4

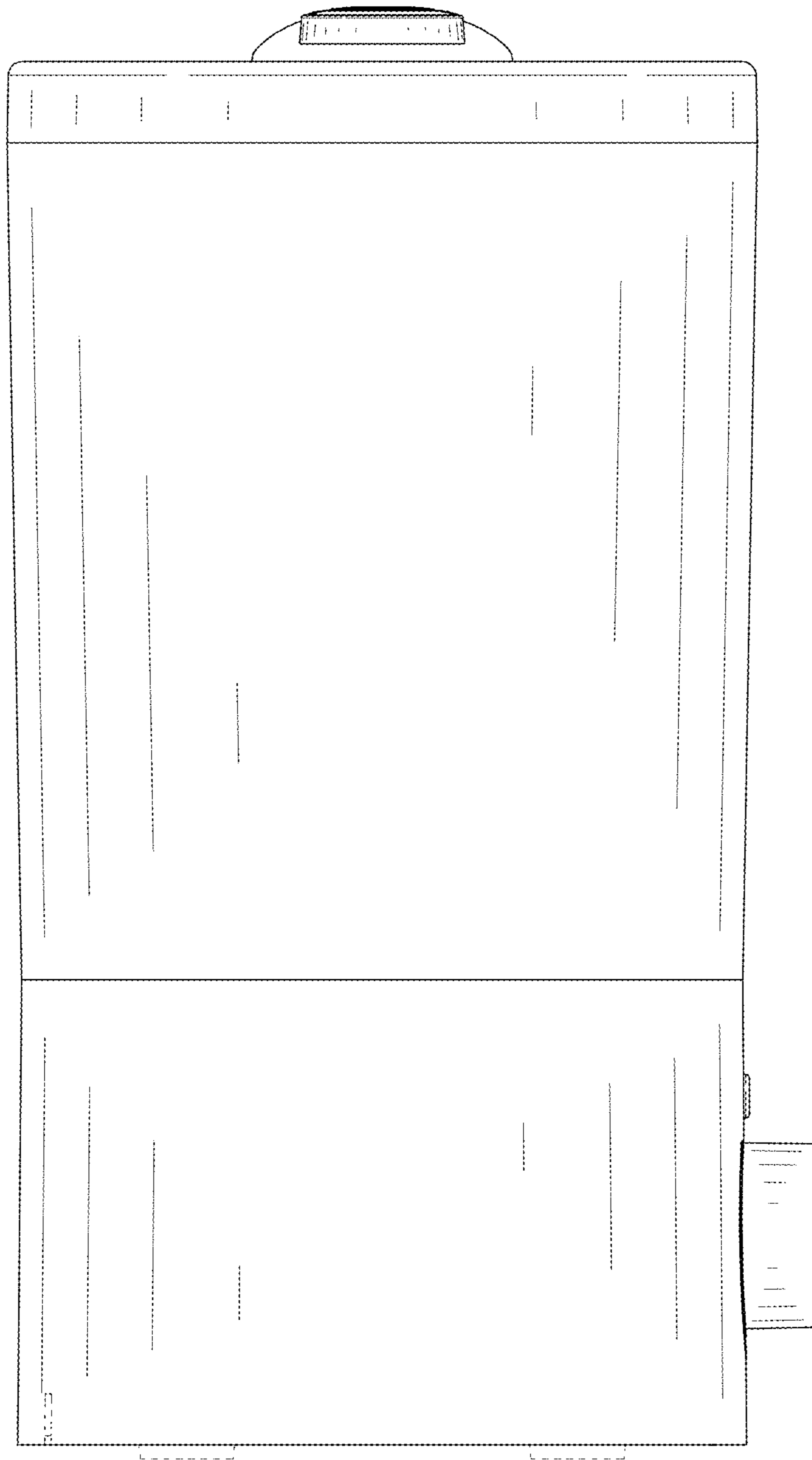

FIG. 5

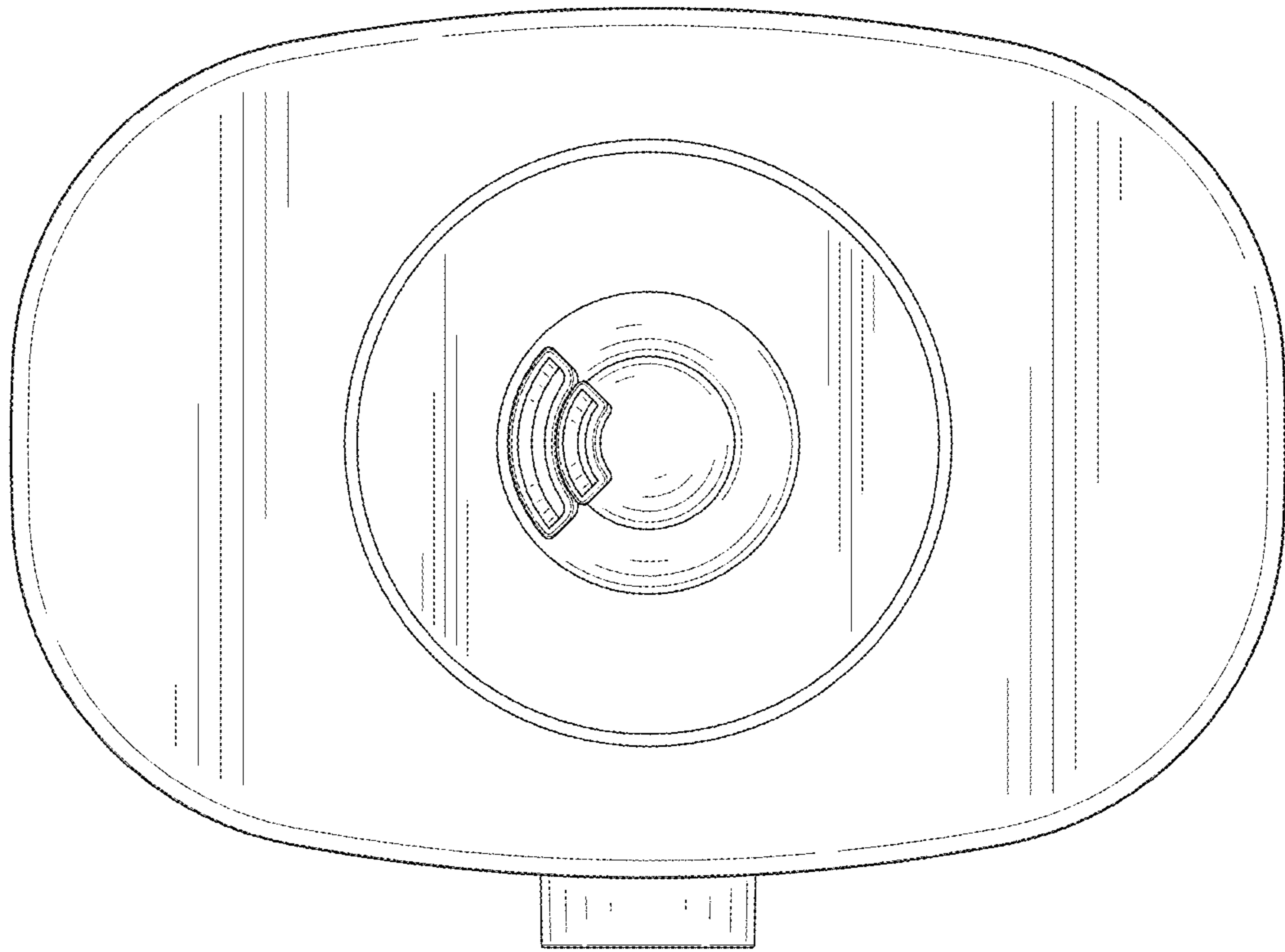

FIG. 6

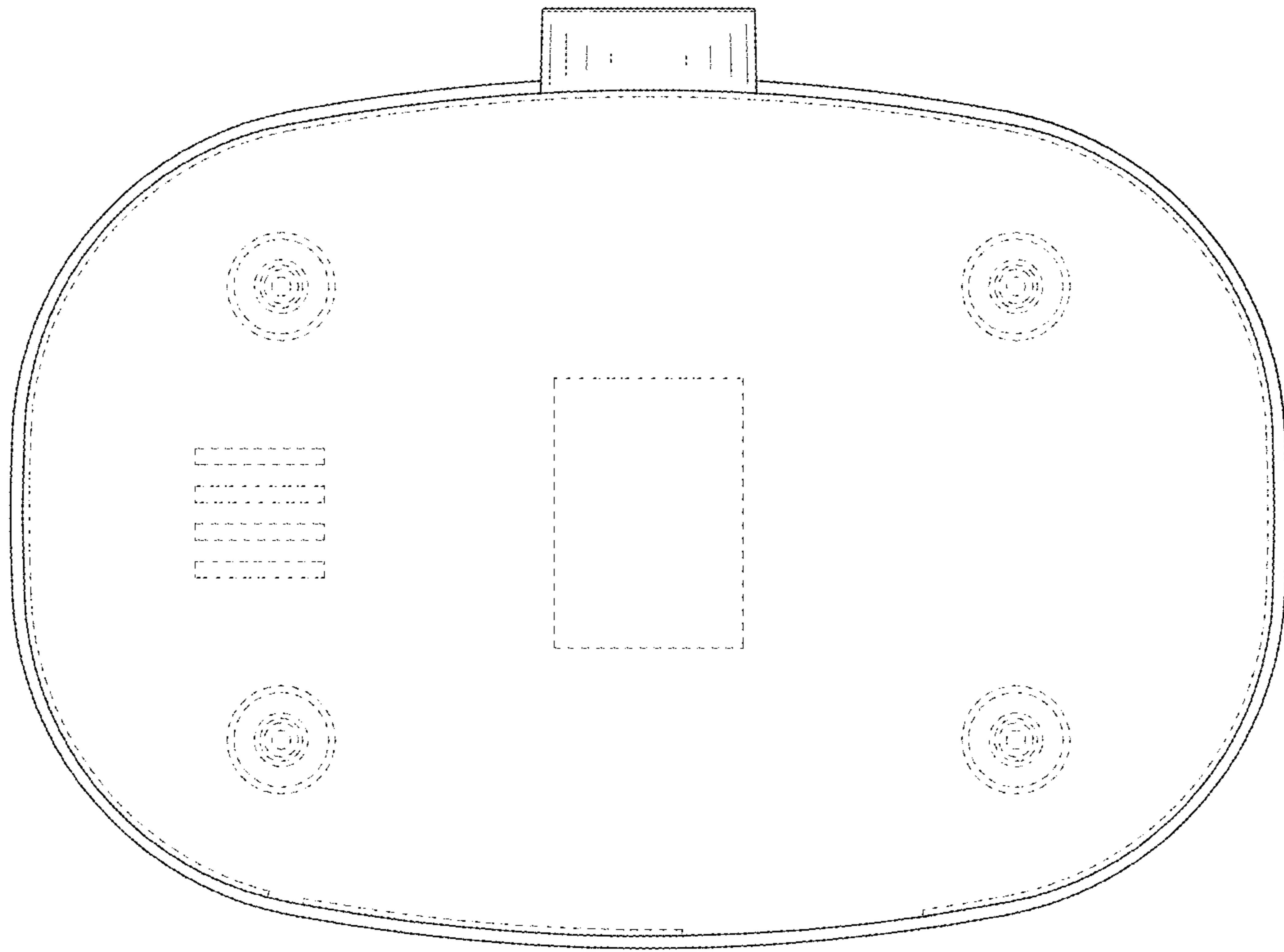

FIG. 7