

US00D960315S

(12) **United States Design Patent** (10) **Patent No.:** **US D960,315 S**  
**Dougan et al.** (45) **Date of Patent:** **\*\* Aug. 9, 2022**

(54) **SPRINKLER**  
(71) Applicant: **SDS Asia Limited, BVI #1748971,**  
Hong Kong (CN)  
(72) Inventors: **Kerry Dougan,** Diamond Point, NY  
(US); **Matt Famigletti,** East Hartford,  
CT (US)  
(73) Assignee: **SDS ASIA LIMITED, BVI 31748971,**  
Central Hong Kong (CN)  
(\*\*) Term: **15 Years**  
(21) Appl. No.: **29/751,592**  
(22) Filed: **Sep. 22, 2020**  
(51) **LOC (13) Cl.** ..... **23-01**  
(52) **U.S. Cl.**  
USPC ..... **D23/215**  
(58) **Field of Classification Search**  
USPC ..... D23/213, 214, 215, 222, 223, 224, 226,  
D23/229, 230, 256; D21/611, 617  
CPC ..... A61H 9/0021; A61H 33/00; B05B 1/00;  
B05B 1/14; B05B 1/185; B05B 1/08;  
B05B 1/02; B05B 1/26; B05B 12/002;  
B05B 1/18; B05B 9/01  
See application file for complete search history.

D936,788 S \* 11/2021 Lei ..... D23/214  
D939,045 S \* 12/2021 Dougan ..... D23/215  
D940,822 S \* 1/2022 Chen ..... D23/215

**OTHER PUBLICATIONS**

Inflatable Ride-On Puppy Dog Sprinkler Inflation in Time Lapse,  
Feb. 27, 2020, youtube.com, Oct. 22, 2021, URL: <https://www.youtube.com/watch?v=8Z16KG3yofk> (Year: 2020).\*  
Official Spot the Dog Large Soft Toy , Nov. 8, 2019, amazon.co.uk,  
Oct. 22, 2021, URL: <https://www.amazon.co.uk/Rainbow-Designs-Laying-Large-SD1655/dp/B081719Q5X> (Year: 2019).\*  
ALEKO Haunted Halloween Dog Yard Inflatable, Aug. 5, 2019,  
amazon.co.uk, Oct. 22, 2021, URL: <https://www.youtube.com/watch?v=OG6FGTAZRbw> (Year: 2019).\*  
SOUSEE Walking Animal Balloons Pet Dog, Apr. 18, 2020, amazon.  
com, Jan. 28, 2022, URL: <https://www.amazon.com/dp/B07Y465NMX/> (Year: 2020).\*  
Toysmith Sprinkler Buddies Mist-lcal Unicorn, May 4, 2019, amazon.  
ca, Jan. 28, 2022, URL: <https://www.amazon.ca/Toysmith-Sprinkler-Buddies-Mist-lcal-Inflatable/dp/B07NY4Y15H/> (Year: 2019).\*

\* cited by examiner

*Primary Examiner* — Keith J Wilson  
(74) *Attorney, Agent, or Firm* — Suiter Swantz pc llo

(57) **CLAIM**

The ornamental design for a sprinkler, as shown and described.

**DESCRIPTION**

FIG. 1 is a perspective view showing our new design;  
FIG. 2 is a left side view thereof;  
FIG. 3 is a right side view thereof;  
FIG. 4 is a front elevation view thereof;  
FIG. 5 is a rear elevation view thereof;  
FIG. 6 is a top plan view thereof; and,  
FIG. 7 is a bottom plan elevation view thereof.  
The broken lines showing anchor straps, seams, and valves  
of FIGS. 1-7 form no part of the claimed design.

**1 Claim, 7 Drawing Sheets**

(56) **References Cited**  
U.S. PATENT DOCUMENTS  
D390,312 S \* 2/1998 West ..... D23/215  
D558,935 S \* 1/2008 Rutherford ..... D21/611  
D661,891 S \* 6/2012 van der Lande ..... D3/211  
D662,158 S \* 6/2012 Shaw ..... D21/611  
D711,507 S \* 8/2014 Smith ..... D23/215  
D753,239 S \* 4/2016 Hengel ..... D21/576  
D759,767 S \* 6/2016 Majure Maysan ..... D21/612  
D809,072 S \* 1/2018 Ambroggio ..... D21/611  
D933,780 S \* 10/2021 Qian ..... D23/215

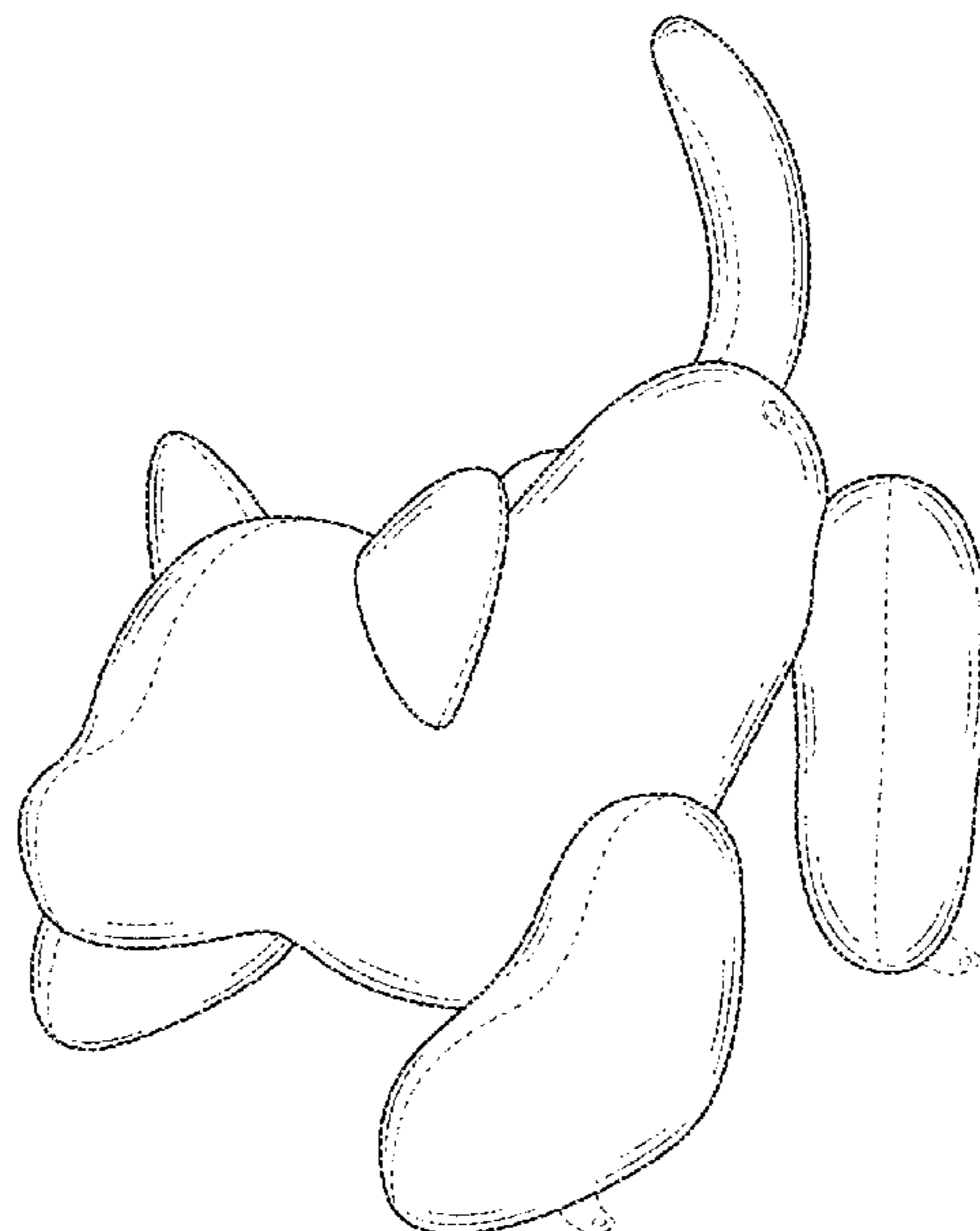

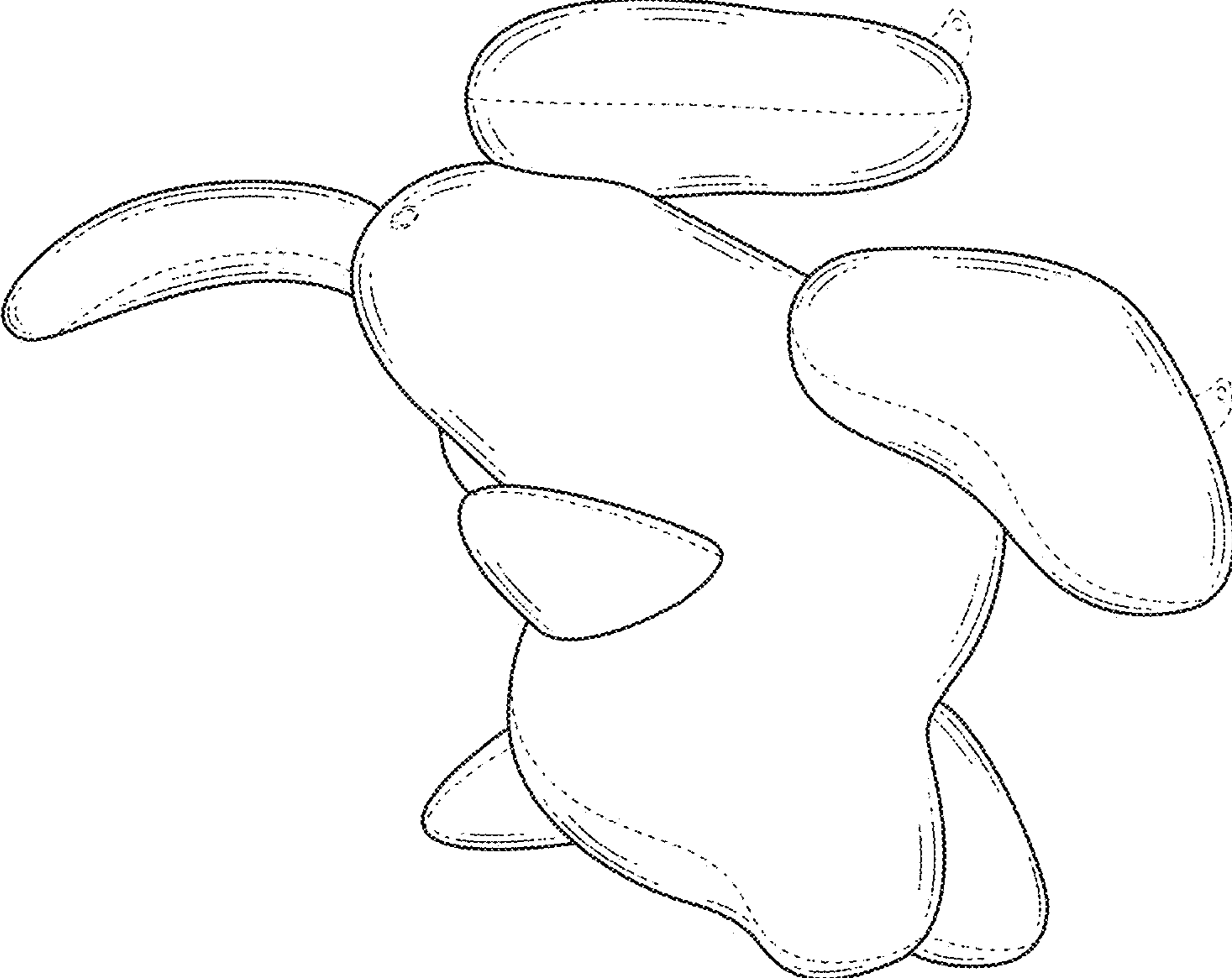

FIG.1

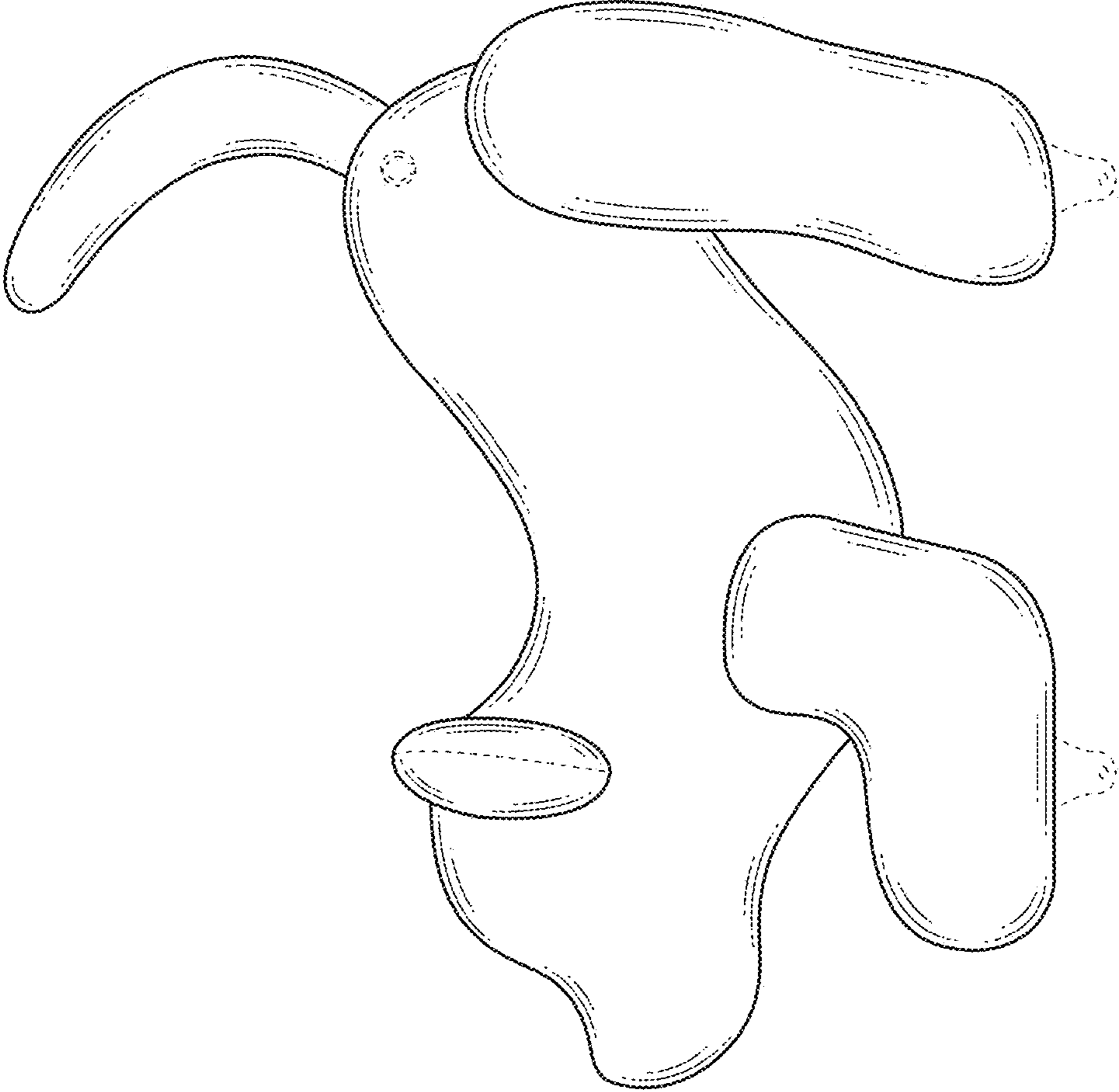

FIG.2

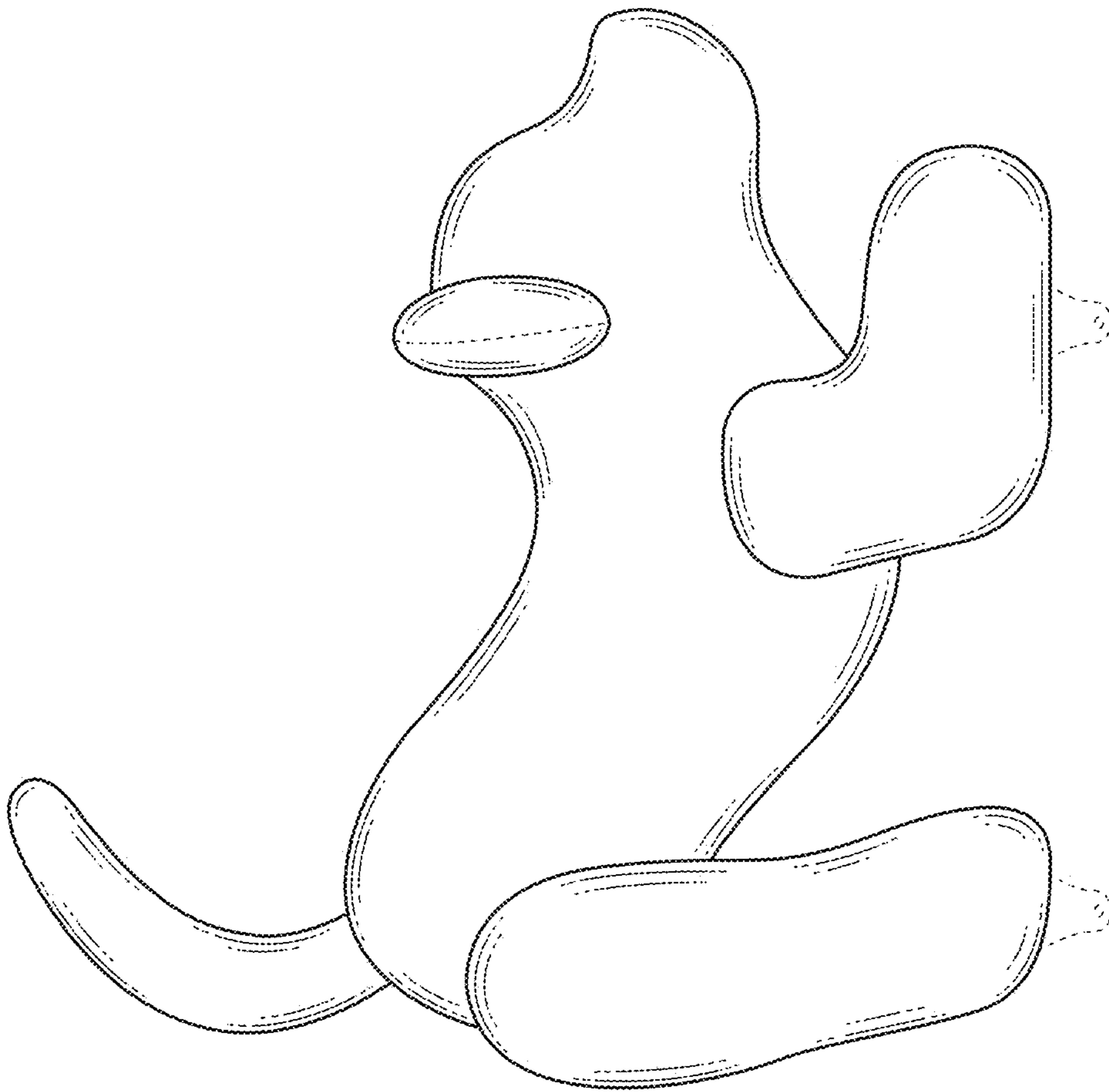

FIG. 3

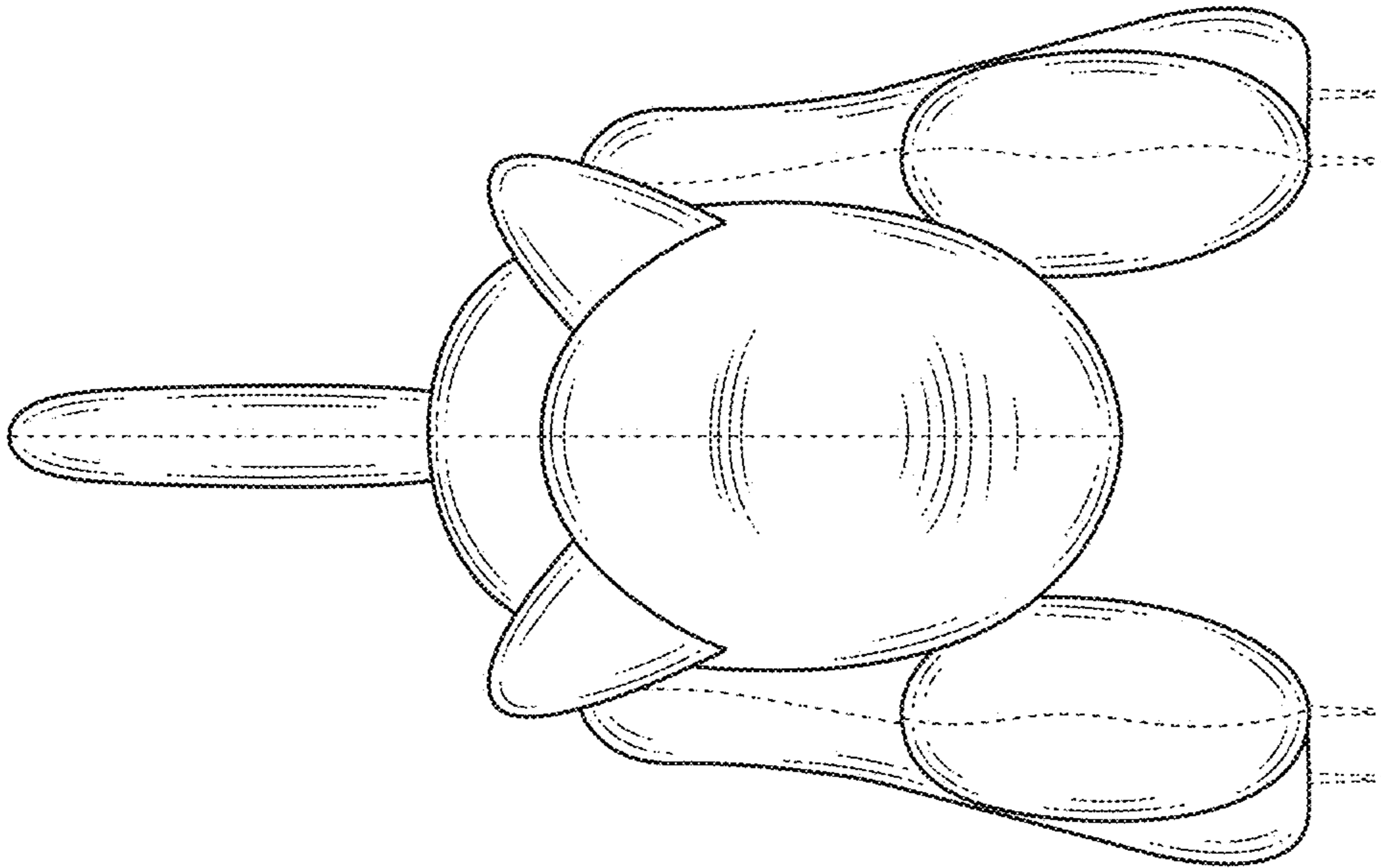

FIG.4

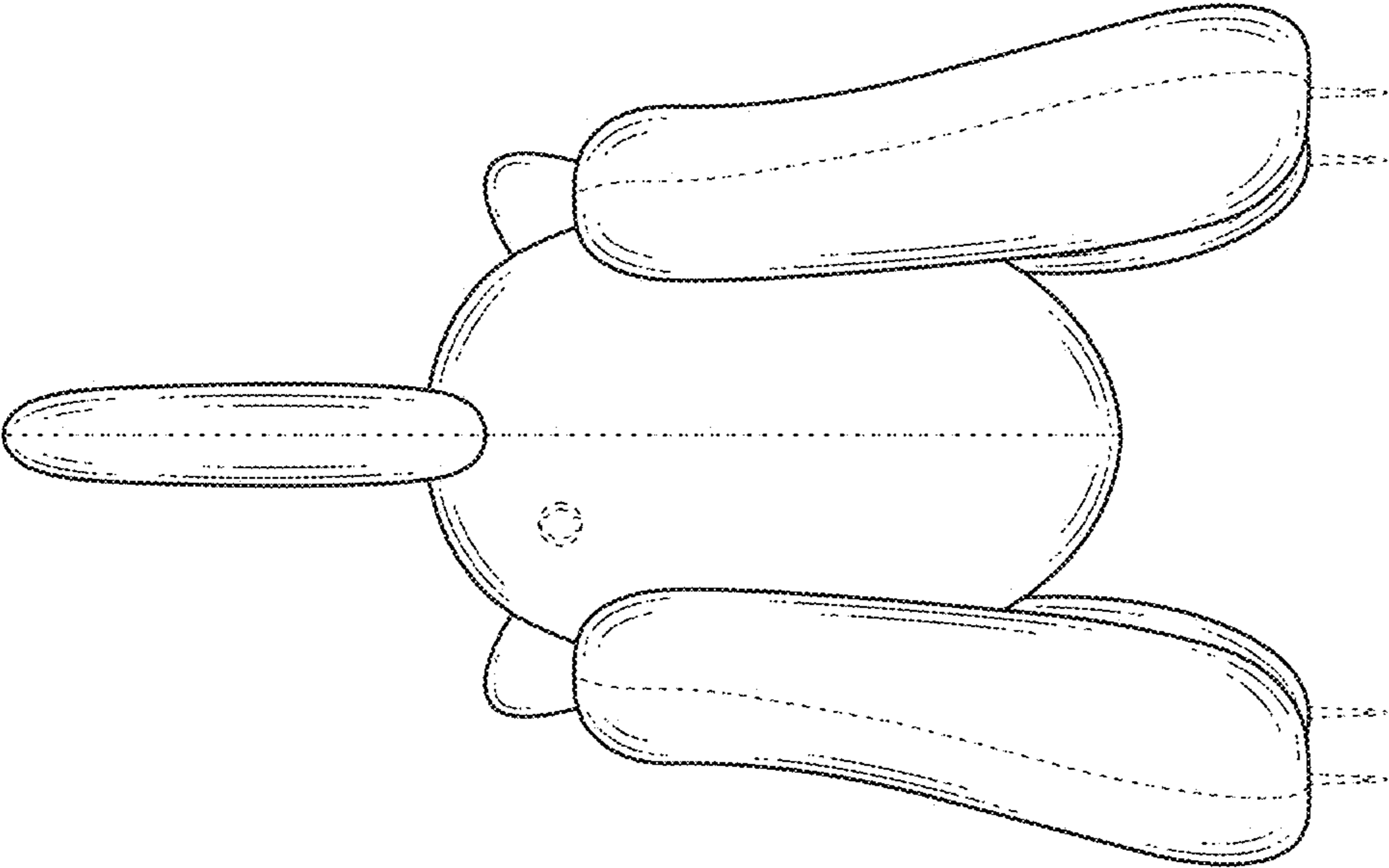

FIG. 5



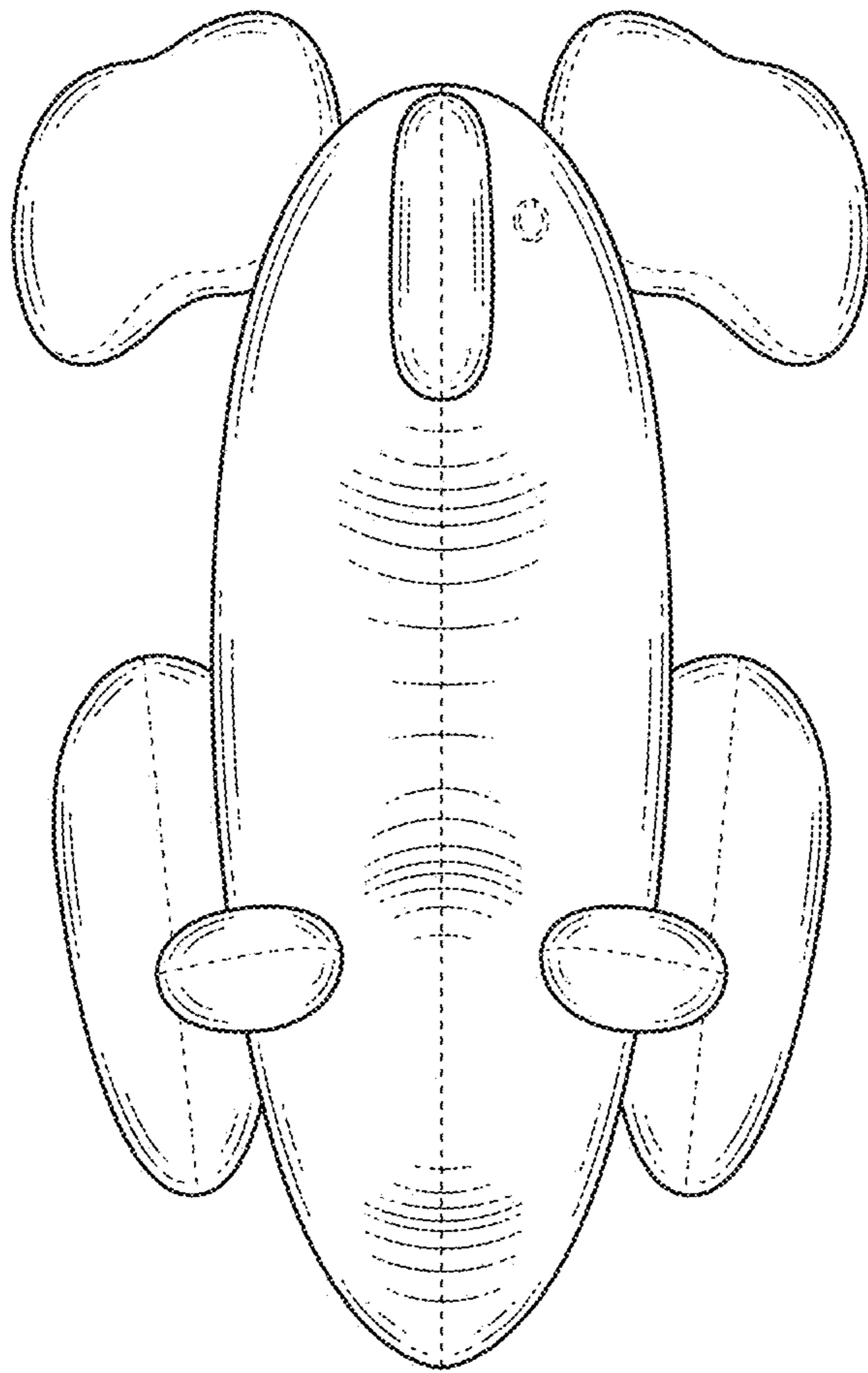

FIG.6

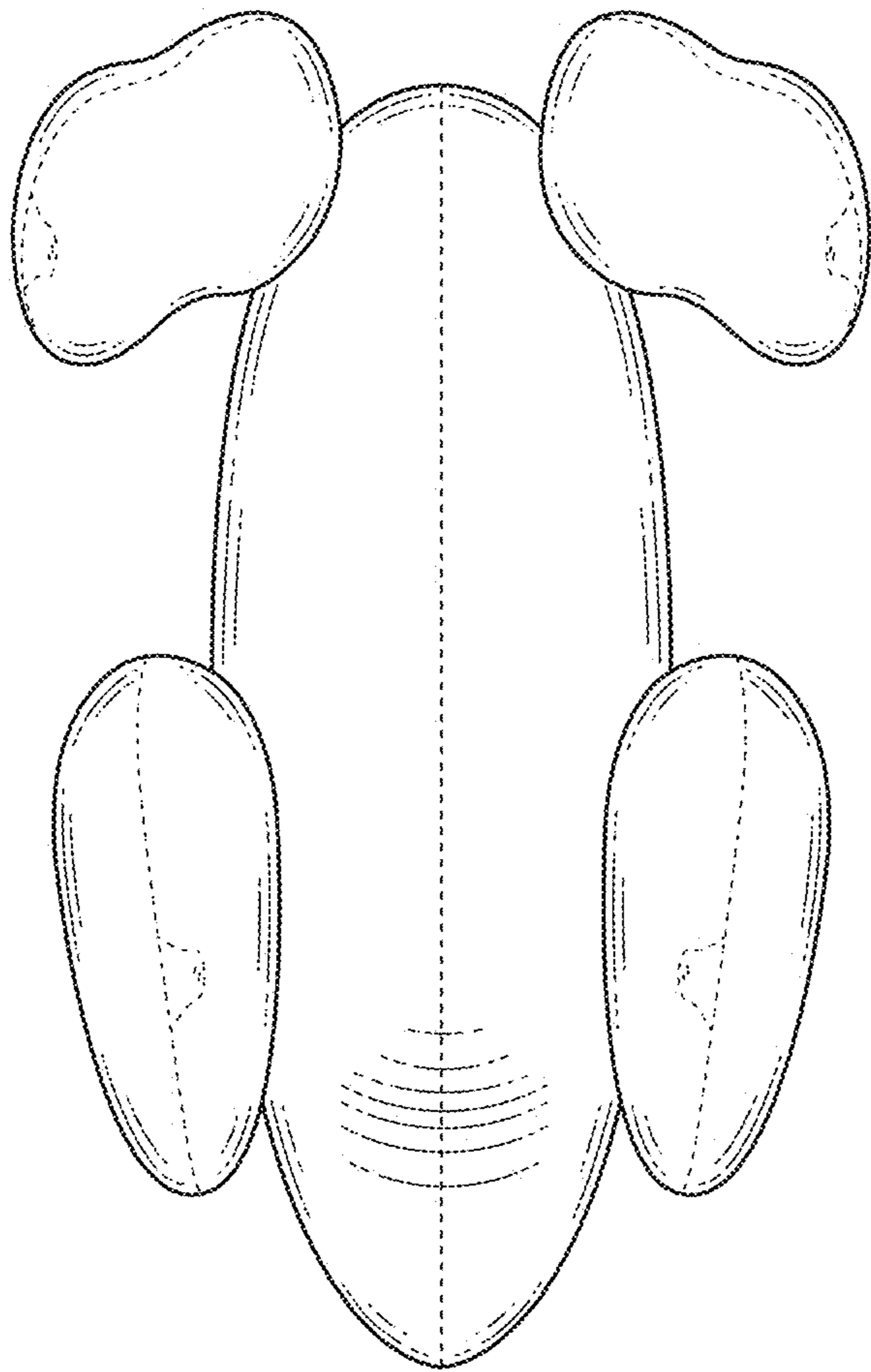

FIG.7