



US00D960314S

(12) **United States Design Patent**
Dougan et al.

(10) **Patent No.:** **US D960,314 S**
(45) **Date of Patent:** **** Aug. 9, 2022**

(54) **SPRINKLER**

(71) Applicant: **SDS Asia Limited, BVI #1748971,**
Hong Kong (CN)

(72) Inventors: **Kerry Dougan,** Diamond Point, NY
(US); **Matt Famigletti,** East Hartford,
CT (US)

(73) Assignee: **SDS ASIA LIMITED, BVI #1748971,**
Central Hong Kong (CN)

(**) Term: **15 Years**

(21) Appl. No.: **29/751,585**

(22) Filed: **Sep. 22, 2020**

(51) **LOC (13) Cl.** **23-01**

(52) **U.S. Cl.**
USPC **D23/215; D21/619**

(58) **Field of Classification Search**
USPC D23/213, 214, 215, 222, 223, 224, 226,
D23/229, 230, 256; D21/619
CPC A61H 9/0021; A61H 33/00; B05B 1/00;
B05B 1/14; B05B 1/185; B05B 1/08;
B05B 1/02; B05B 1/26; B05B 12/002;
B05B 1/18; B05B 9/01

See application file for complete search history.

(56) **References Cited**

U.S. PATENT DOCUMENTS

D282,248 S *	1/1986	Carbajales Santa-Eulalia	D11/158
D291,716 S *	9/1987	Wolfe	D21/619
D388,479 S *	12/1997	Allegre	D21/619
D541,355 S *	4/2007	Strasbach	D21/619
D601,209 S *	9/2009	Visser	D21/619
D625,781 S *	10/2010	Ruckelshausen	D23/256
D673,229 S *	12/2012	Ent	D21/619
D865,073 S *	10/2019	Weisman	D21/473

D912,165 S *	3/2021	Deutsch	D21/616
D920,474 S *	5/2021	Fu	D23/222
D921,128 S *	6/2021	Chow	D21/616
D921,129 S *	6/2021	Chow	D21/616
D928,286 S *	8/2021	Huang	D23/214
D933,780 S *	10/2021	Qian	D23/215

OTHER PUBLICATIONS

SimpliCute Stuffed Giraffe Plush, Mar. 26, 2021, Amazon.com, Jul. 28, 2021.URL: <https://www.amazon.com/dp/B08TQKHZCZ> (Year: 2021).*

Jehlani The Giraffe—18 Inch Stuffed Animal Plush, Dec. 10, 2017, Amazon.com, Jul. 28, 2021.URL: <https://www.amazon.com/VIAHART-Jehlani-Giraffe-Stuffed-Animal/dp/B06XJ9D524> (Year: 2017).*

Aurora World Aurora—Destination—15" Giraffe, May 19, 2014, Amazon.com, Jul. 28, 2021.URL: <https://www.amazon.com/Aurora-World-Destination-Nation-Giraffe/dp/B00B90OP38> (Year: 2014).*

(Continued)

Primary Examiner — Keith J Wilson

(74) *Attorney, Agent, or Firm* — Suiter Swantz pc llo

(57) **CLAIM**

The ornamental design for a sprinkler, as shown and described.

DESCRIPTION

FIG. 1 is a perspective view showing our new design;

FIG. 2 is a left side view thereof;

FIG. 3 is a right side view thereof

FIG. 4 is a front elevation view thereof;

FIG. 5 is a rear elevation view thereof;

FIG. 6 is a top plan view thereof; and,

FIG. 7 is a bottom plan elevation view thereof.

The broken lines showing anchor straps, bottoms of the legs, seams, portions of the ears, and a valve of FIGS. 1-7 form no part of the claimed design.

1 Claim, 7 Drawing Sheets

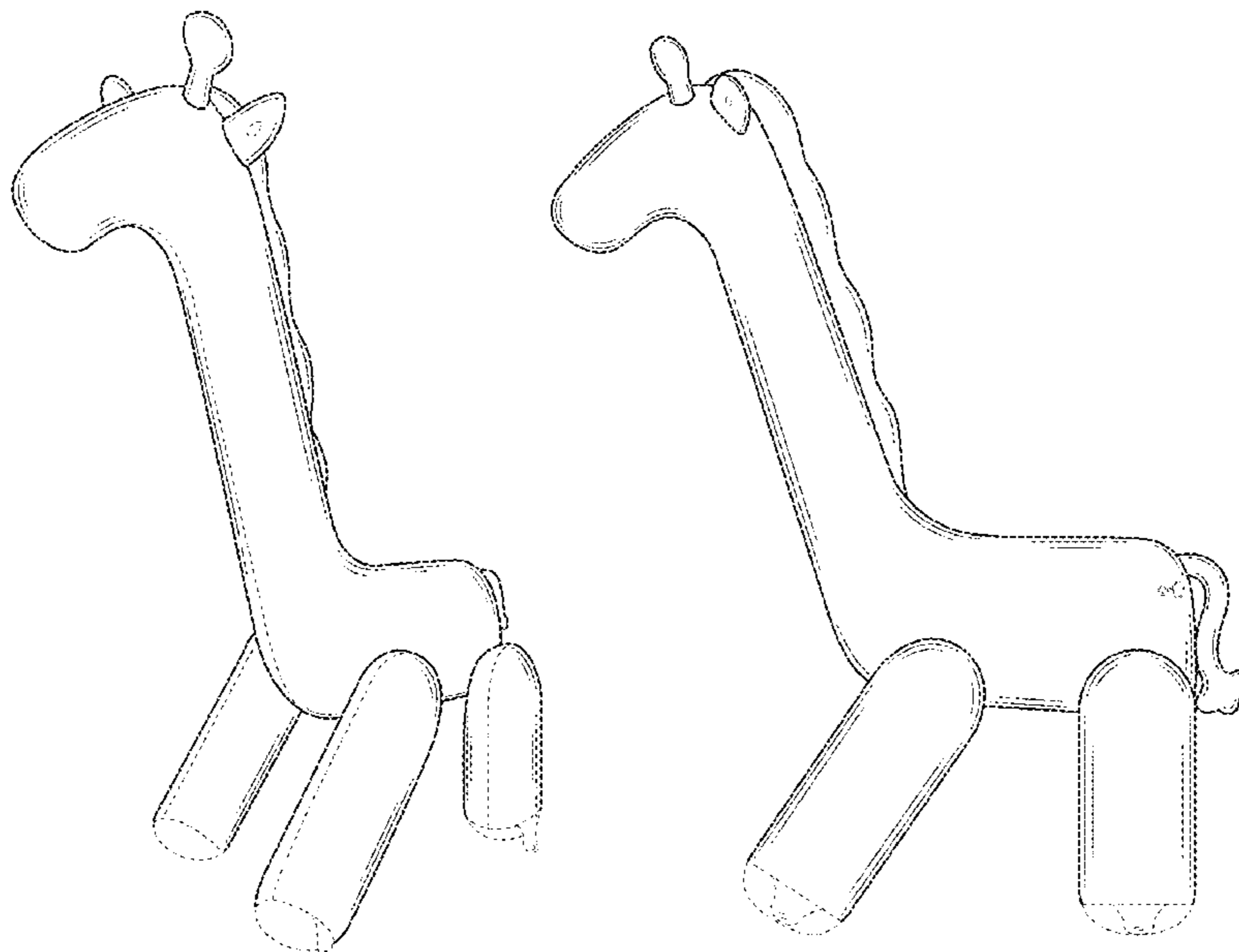

(56)

References Cited

OTHER PUBLICATIONS

H2O GO Jumbo Giraffe Inflatable Sprinkler, Feb. 1, 2021, amazon.com, Dec. 10, 2021, URL: <https://www.amazon.com/H2O-GO-Giraffe-Inflatable-Sprinkler/dp/B08FXWKFBR/> (Year: 2021).*

Jet Creations Inflatable Giraffe Animals, Apr. 1, 2018, amazon.com, Dec. 10, 2021, URL: <https://www.amazon.com/dp/B07BV6BTHV/> (Year: 2018).*

* cited by examiner

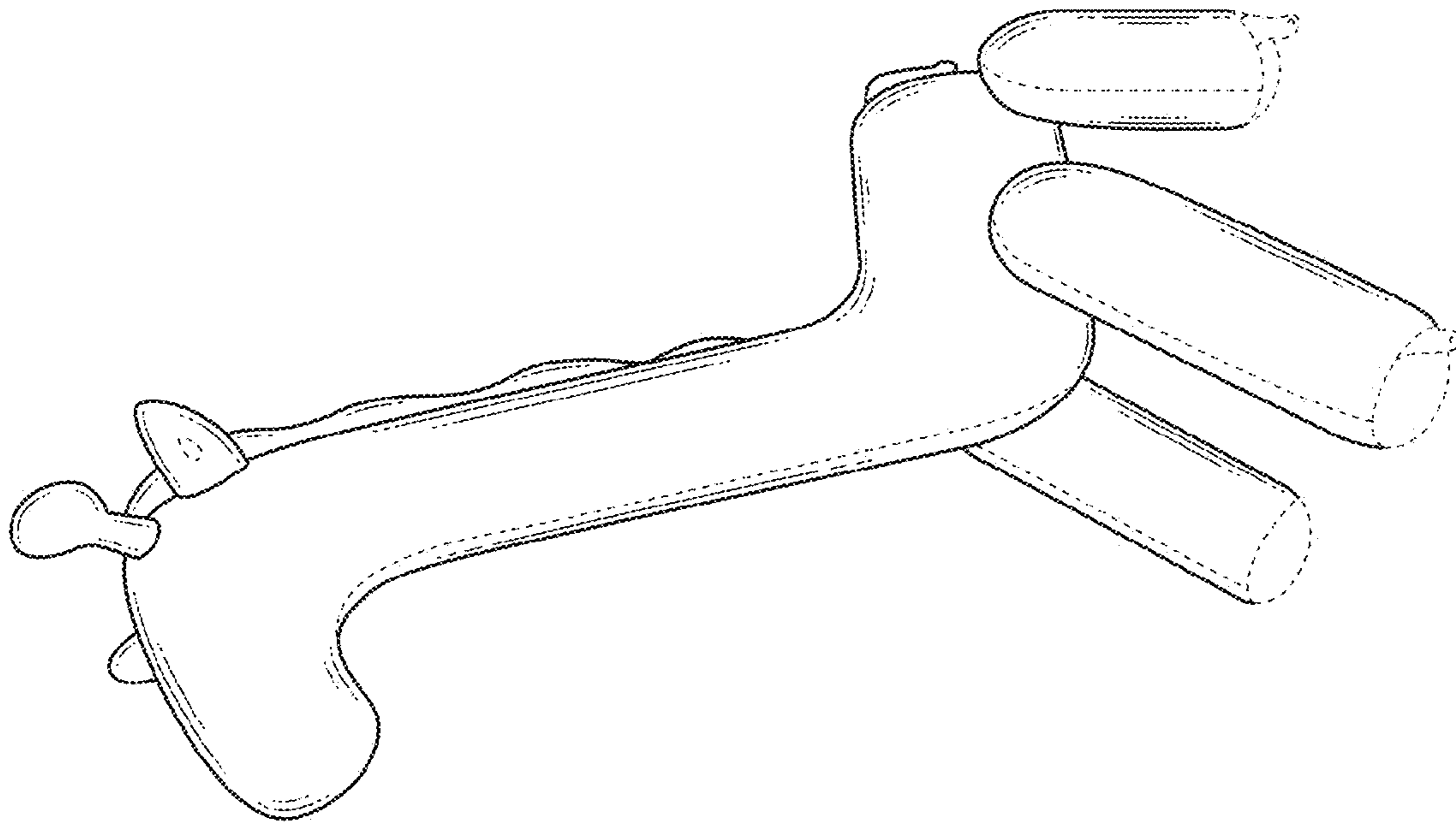

FIG.1

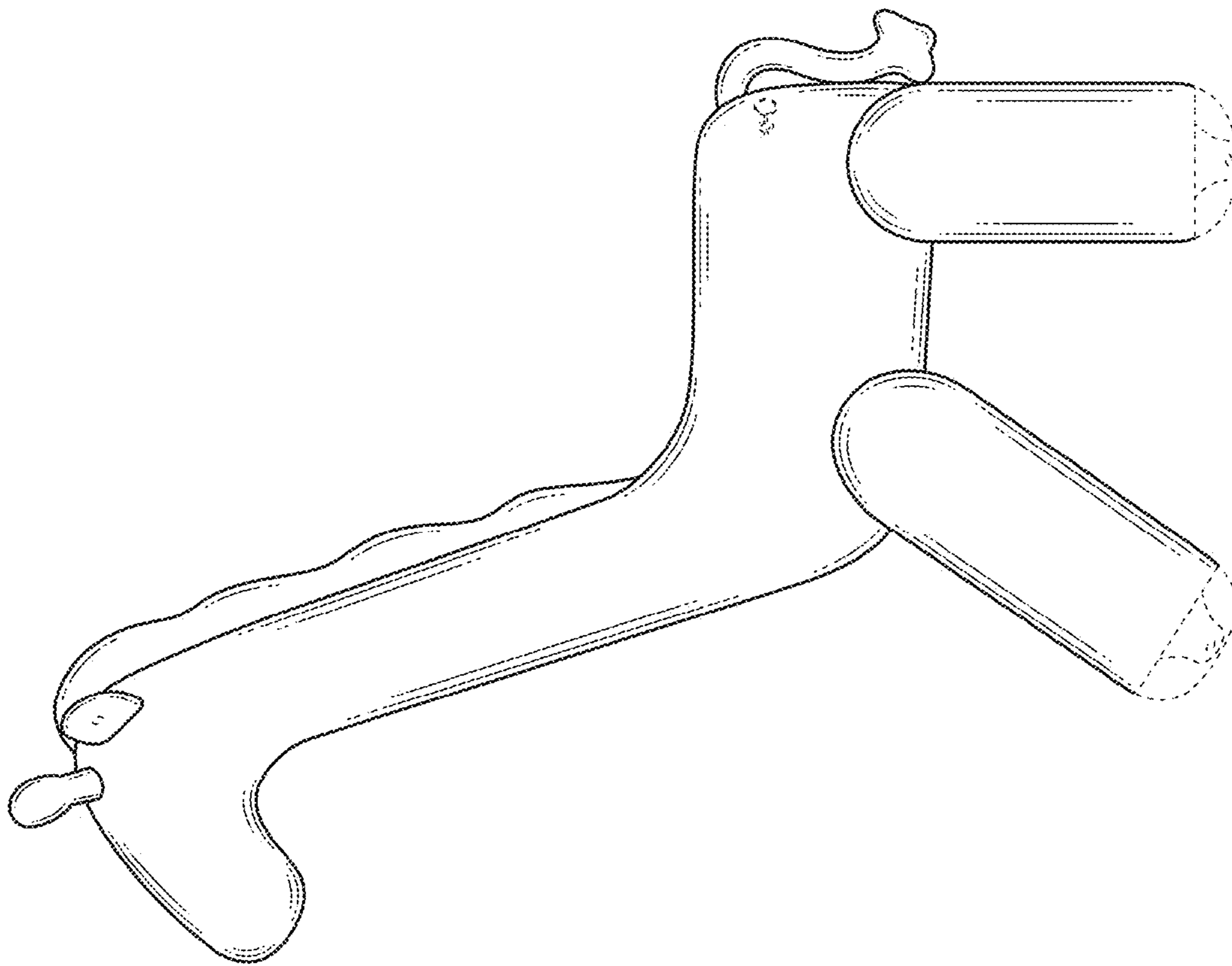

FIG. 2

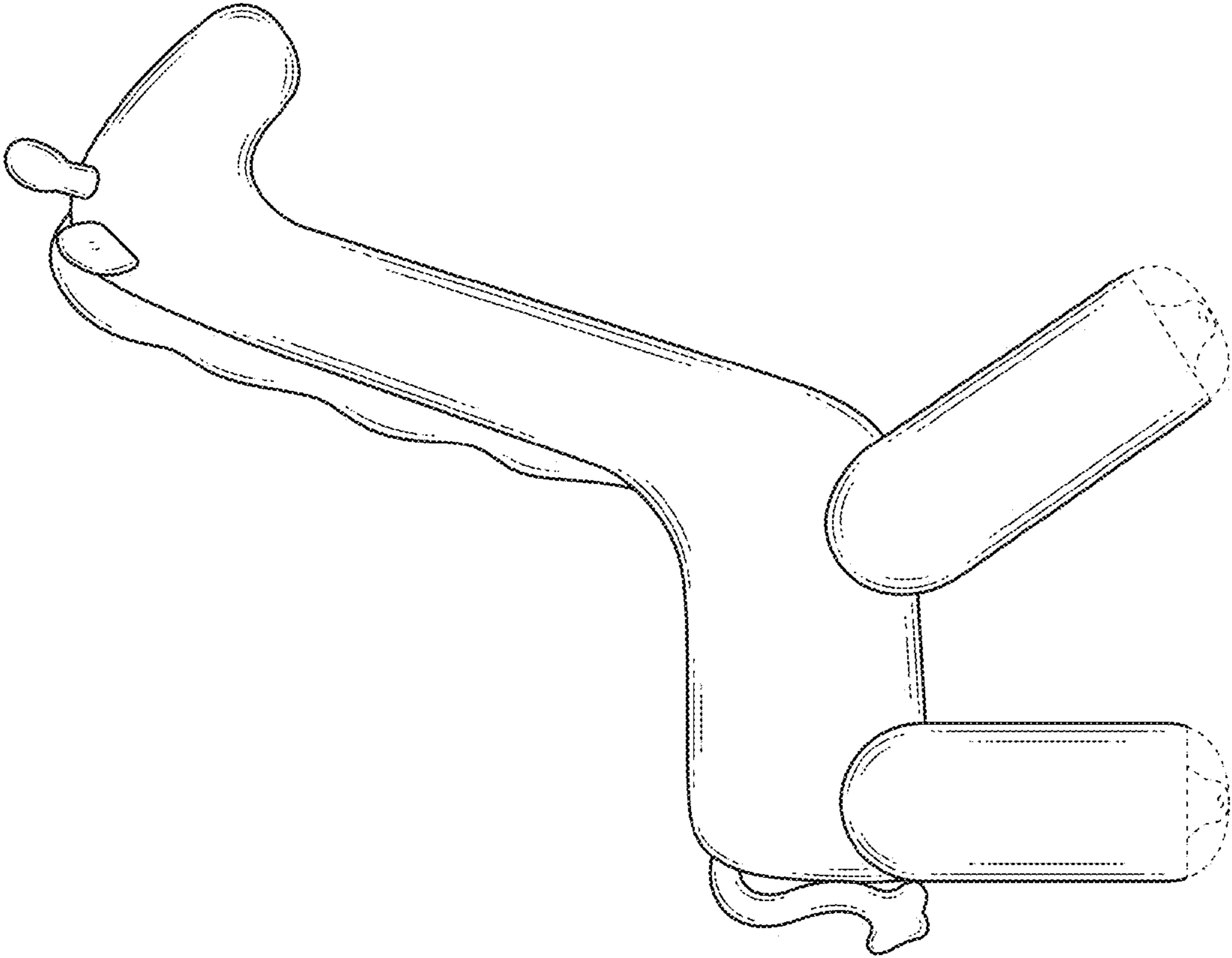

FIG. 3

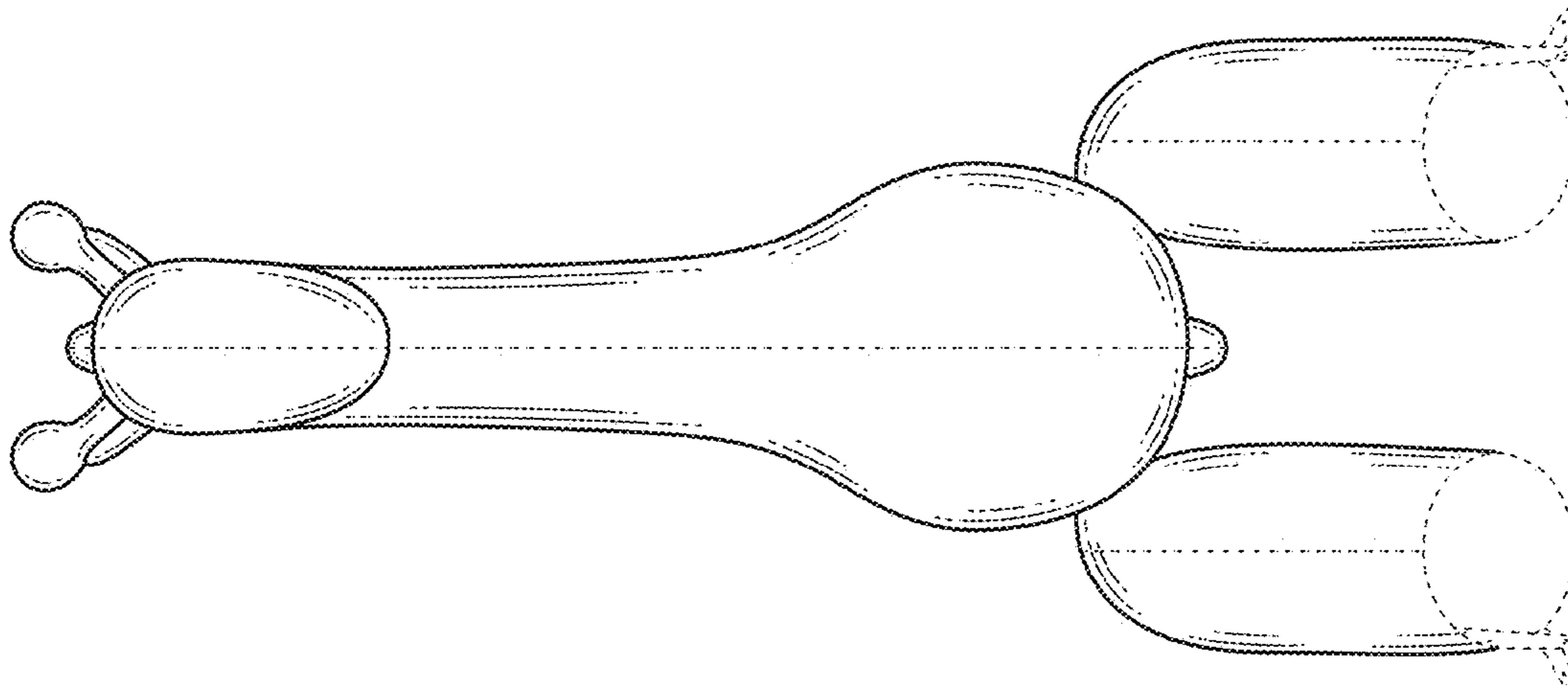

FIG.4

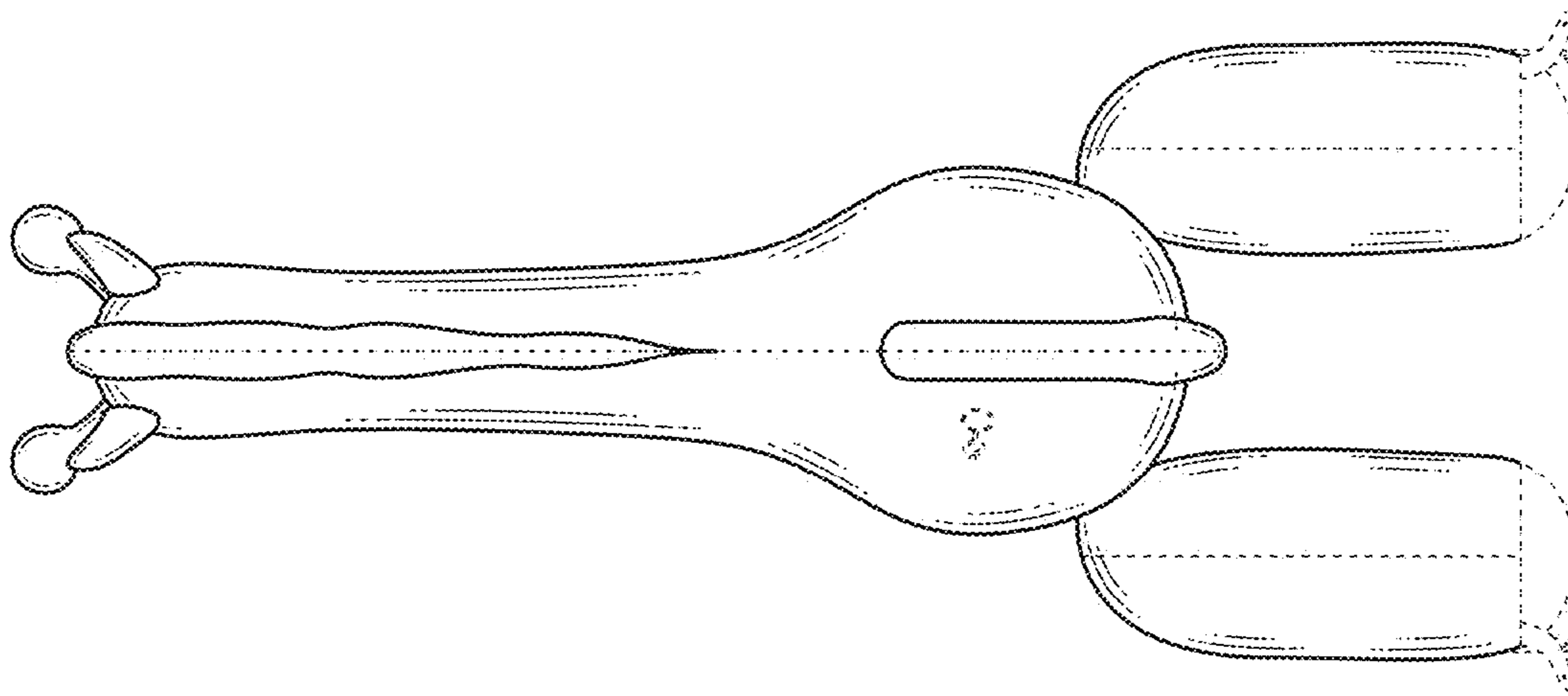

FIG. 5

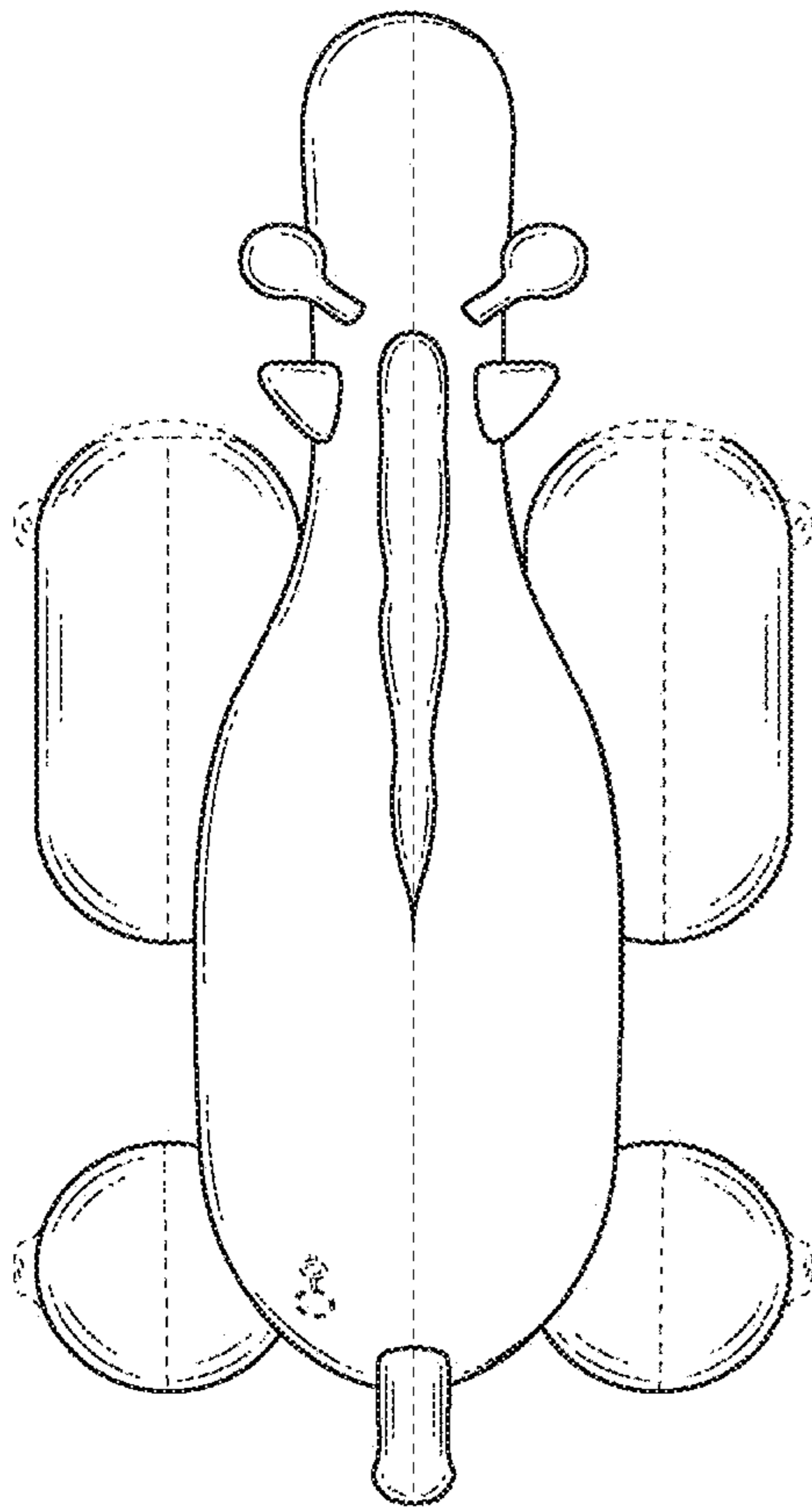

FIG. 6

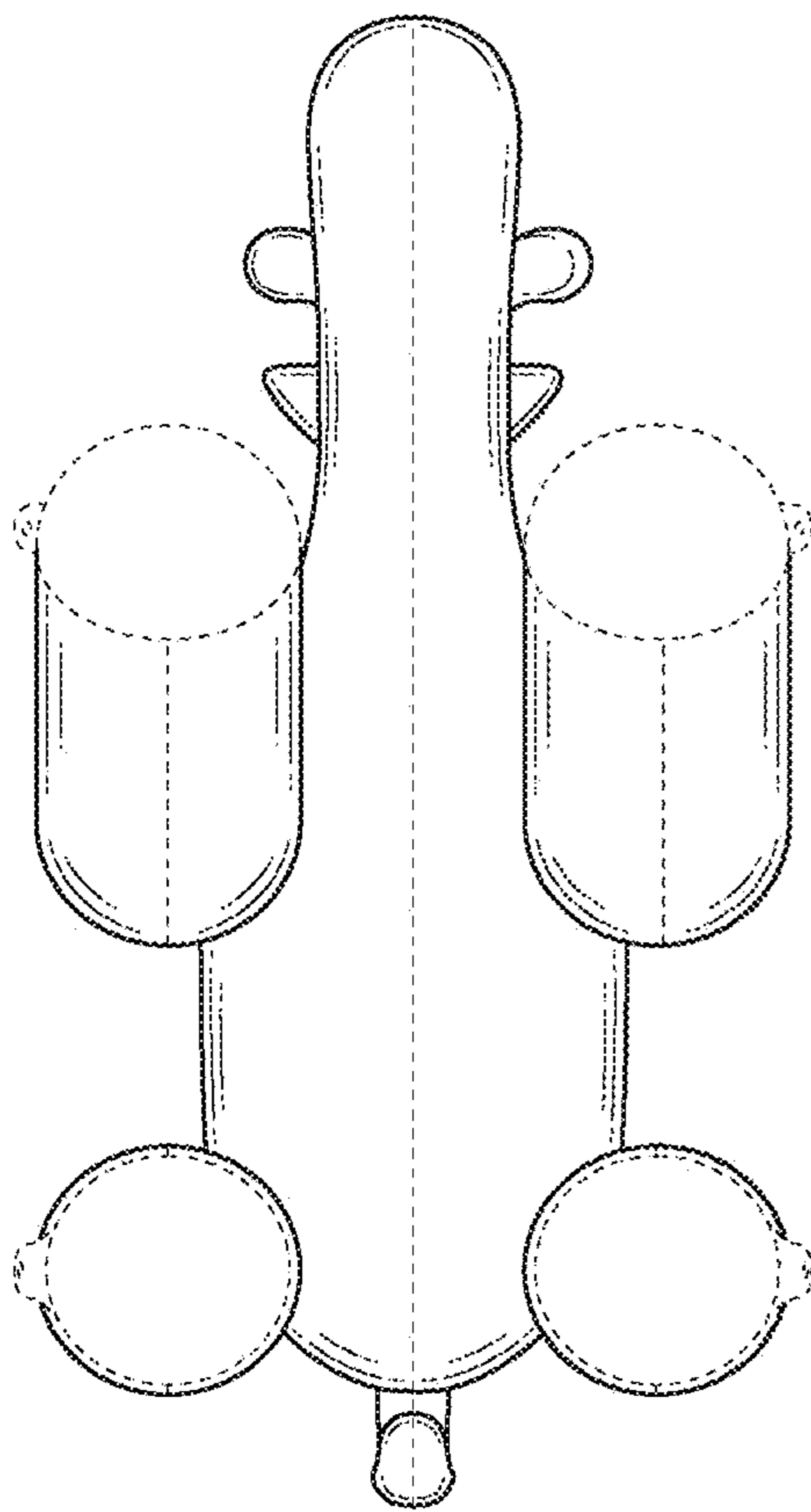

FIG. 7