



US00D960312S

(12) **United States Design Patent**
Chen

(10) **Patent No.:** **US D960,312 S**

(45) **Date of Patent:** **** Aug. 9, 2022**

(54) **SPRINKLER TOY**

(71) Applicant: **Peng Zhou**, Shantou (CN)

(72) Inventor: **Guizhu Chen**, Shantou (CN)

(**) Term: **15 Years**

(21) Appl. No.: **29/767,809**

(22) Filed: **Jan. 26, 2021**

(30) **Foreign Application Priority Data**

Nov. 9, 2020 (CN) 202030674123.X

(51) **LOC (13) Cl.** **23-01**

(52) **U.S. Cl.**
USPC **D23/214**

(58) **Field of Classification Search**
USPC D23/213, 214, 215, 221-222, 223, 224,
D23/226, 229, 230; D21/597
CPC A61H 9/0021; A61H 33/00; B05B 1/00;
B05B 1/14; B05B 1/185; B05B 1/08;
B05B 1/02; B05B 1/26; B05B 12/002;
B05B 1/18; B05B 9/01

See application file for complete search history.

(56) **References Cited**

U.S. PATENT DOCUMENTS

D359,078 S *	6/1995	Bro	D21/474
5,704,549 A *	1/1998	Kephart	B05B 3/021
				239/236
D399,915 S *	10/1998	McEachen	D23/214
D426,284 S *	6/2000	Wang	D23/214
D426,614 S *	6/2000	Wang	D23/214
6,082,633 A *	7/2000	Kephart	B05B 15/625
				239/211
D557,358 S *	12/2007	Boutin	D21/592
D637,668 S *	5/2011	Welch	D21/714
D651,662 S *	1/2012	Monahan	D21/608
D671,601 S *	11/2012	Hornsby	D21/597
D672,825 S *	12/2012	Hornsby	D21/597

D672,826 S *	12/2012	Hornsby	D21/597
D733,224 S *	6/2015	White	D21/597
D751,652 S *	3/2016	Chen	D21/443
D755,446 S *	5/2016	Hansen	D30/121
D776,765 S *	1/2017	Weisman	D21/608
D807,965 S *	1/2018	Lo	D21/401
D872,195 S *	1/2020	Jin	D21/606
D889,964 S *	7/2020	Thai	D9/451
D928,286 S *	8/2021	Huang	D23/214

(Continued)

OTHER PUBLICATIONS

LEADSTAR Bath Bubble Machine, Durable Bath Toys, Crab Bubble, Jun. 1, 2020, amazon.com, Jan. 10, 2022, URL: <https://www.amazon.ca/LEADSTAR-Machine-Automatic-Noiselessly-Toddlers/dp/B089GSCQ1K> (Year: 2020).*

(Continued)

Primary Examiner — Keith J Wilson

(57) **CLAIM**

The ornamental design for a sprinkler toy, as shown and described.

DESCRIPTION

FIG. 1 is a first perspective view of a sprinkler toy showing my new design;
FIG. 2 is a second perspective view thereof;
FIG. 3 is a front view thereof;
FIG. 4 is a back view thereof;
FIG. 5 is a left side view thereof;
FIG. 6 is a right side view thereof;
FIG. 7 is a top view thereof;
FIG. 8 is a bottom view thereof; and,
FIG. 9 is a perspective view of another state of the sprinkler toy thereof.
The broken lines shown in the drawings depict portions of the sprinkler toy in which the design is embodied that form no part of the claimed design.

1 Claim, 9 Drawing Sheets

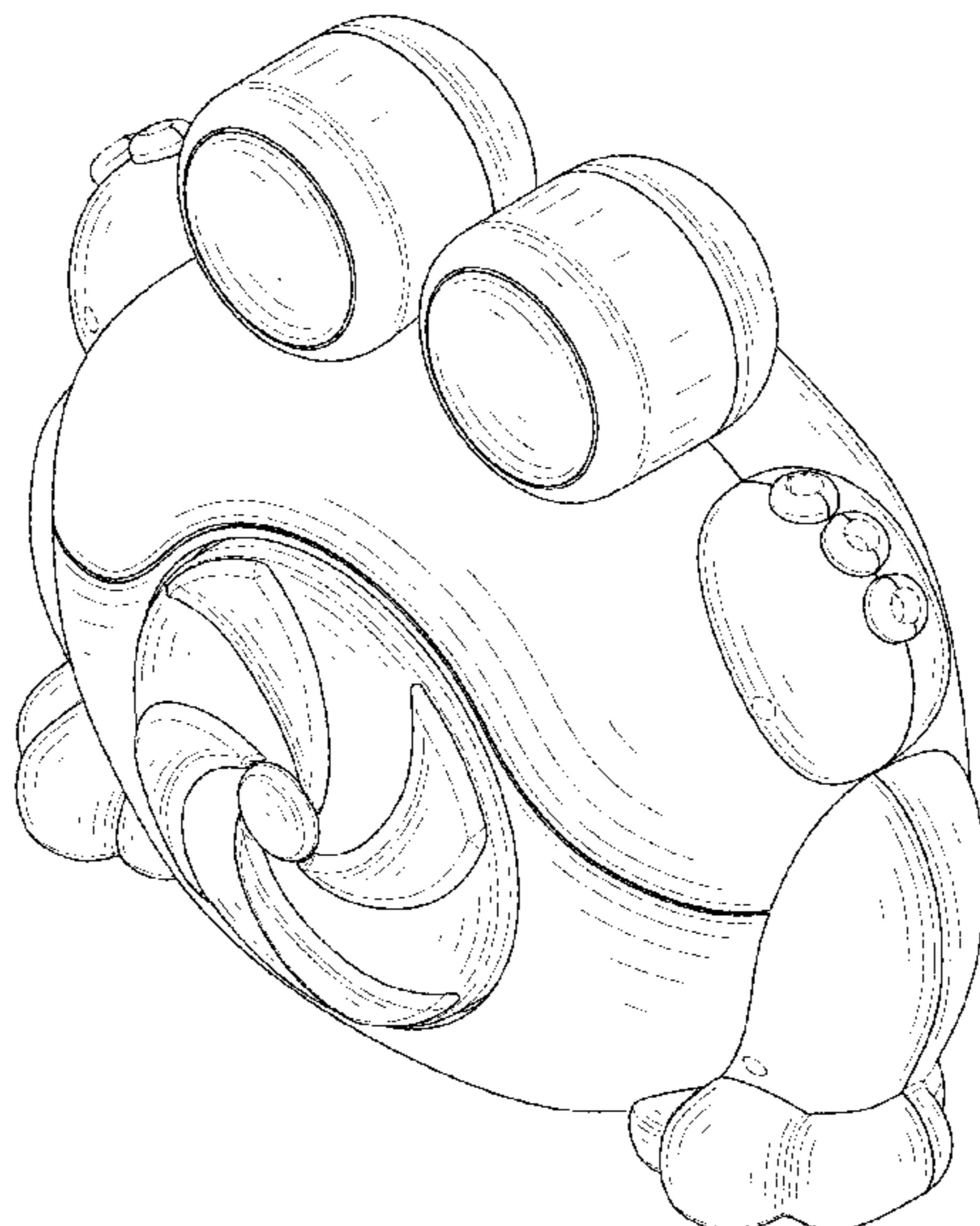

(56)

References Cited

U.S. PATENT DOCUMENTS

D937,935 S * 12/2021 Cai D21/401
D939,045 S * 12/2021 Dougan D23/215
2009/0266908 A1* 10/2009 Michelsen B05B 1/06
239/17

OTHER PUBLICATIONS

Atlasonix Outdoor Water Sprinkler Spray for Kids, Jul. 15, 2020,
amazon.com, Jan. 10, 2022, URL: <https://www.amazon.com/Atlasonix-Outdoor-Water-Sprinkler-Spray/dp/B086LG67XQ> (Year: 2020).*

Timoo Water Sprinkler for Kids Outdoor Play, Crab Kids Sprinkler,
Jan. 6, 2021, amazon.com, Jan. 10, 2022, URL: <https://www.amazon.com/Timoo-Sprinkler-Outdoor-Spinning-Splashing/dp/B08S73R6N4> (Year: 2022).*

* cited by examiner

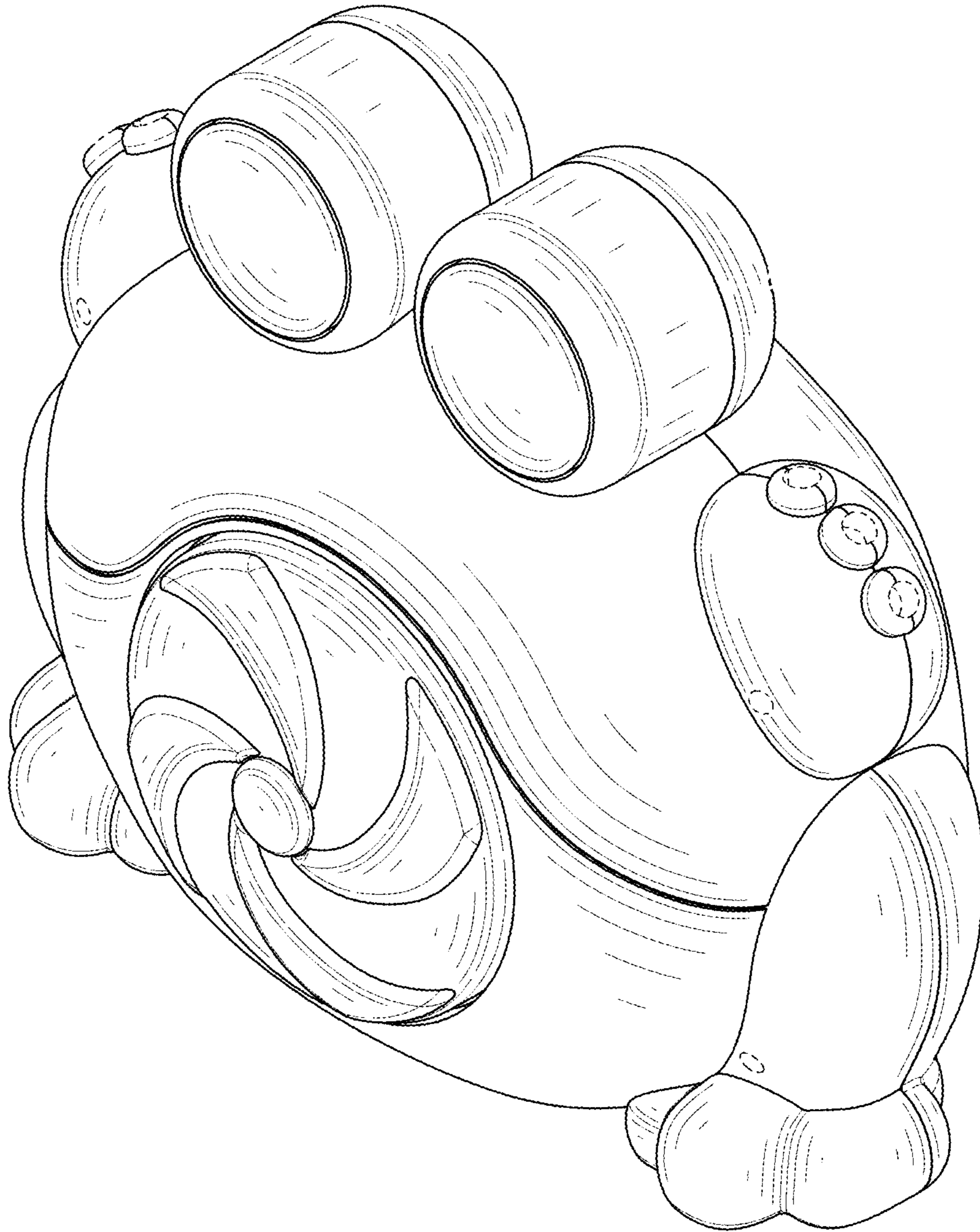

FIG. 1

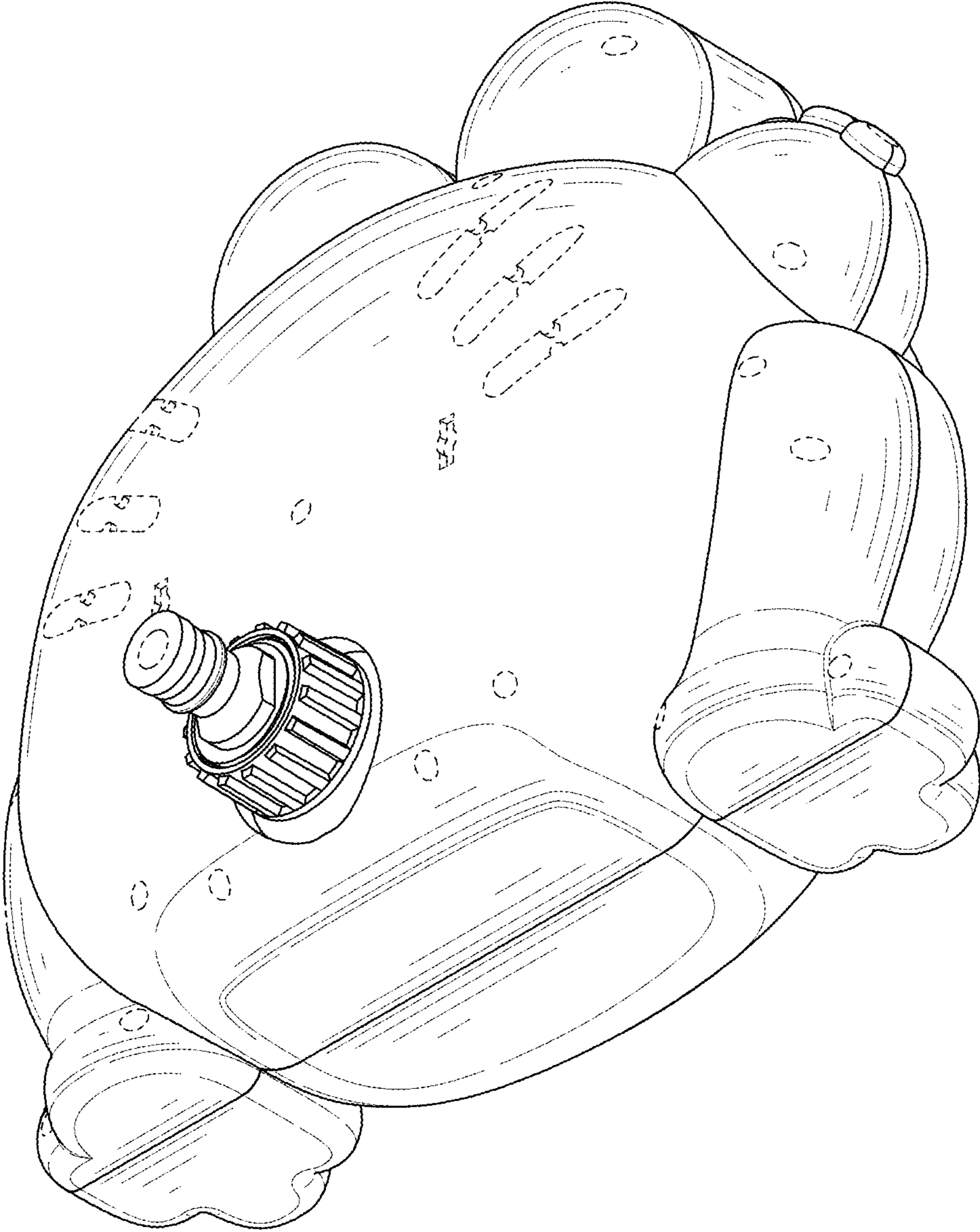

FIG. 2

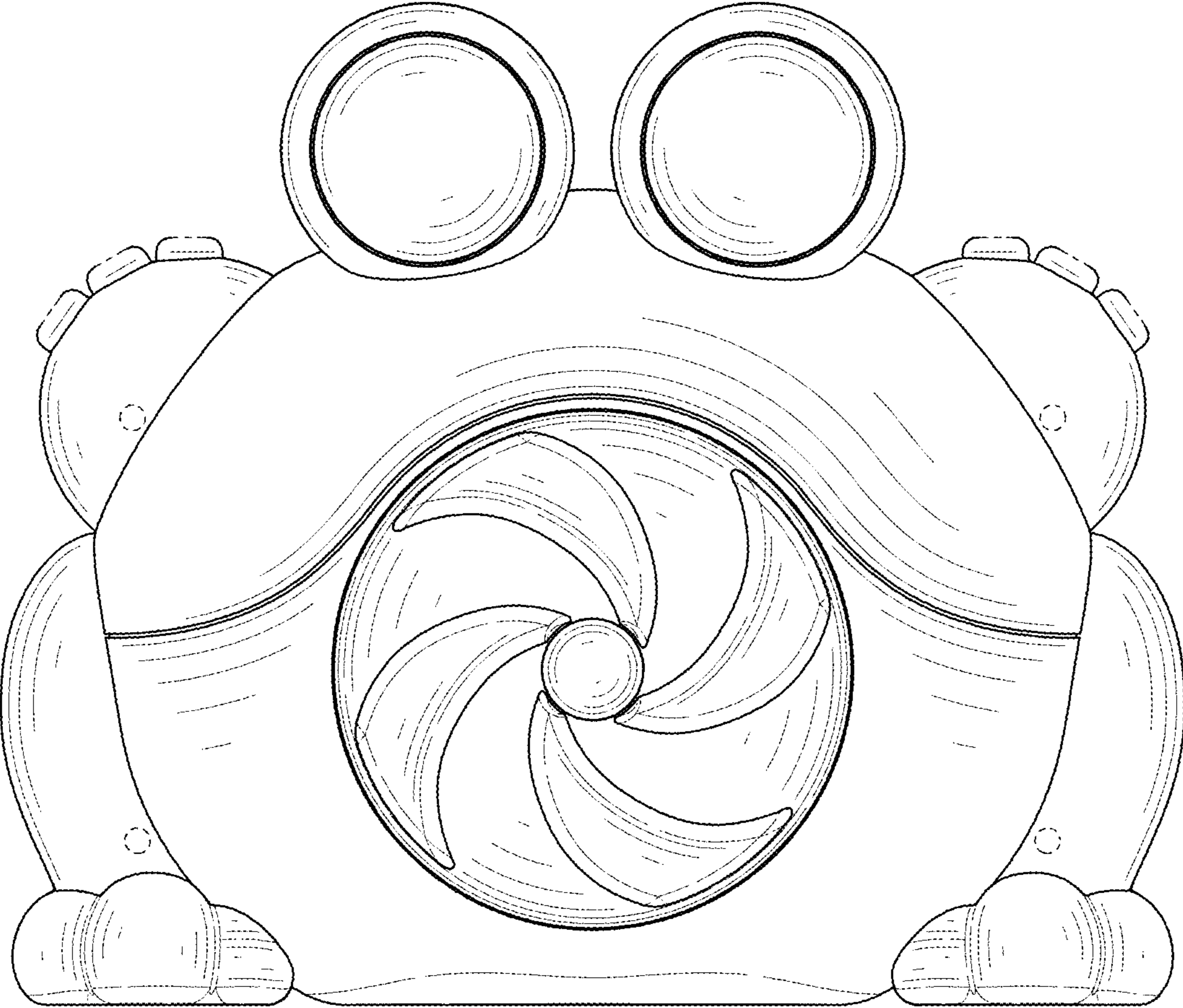

FIG. 3

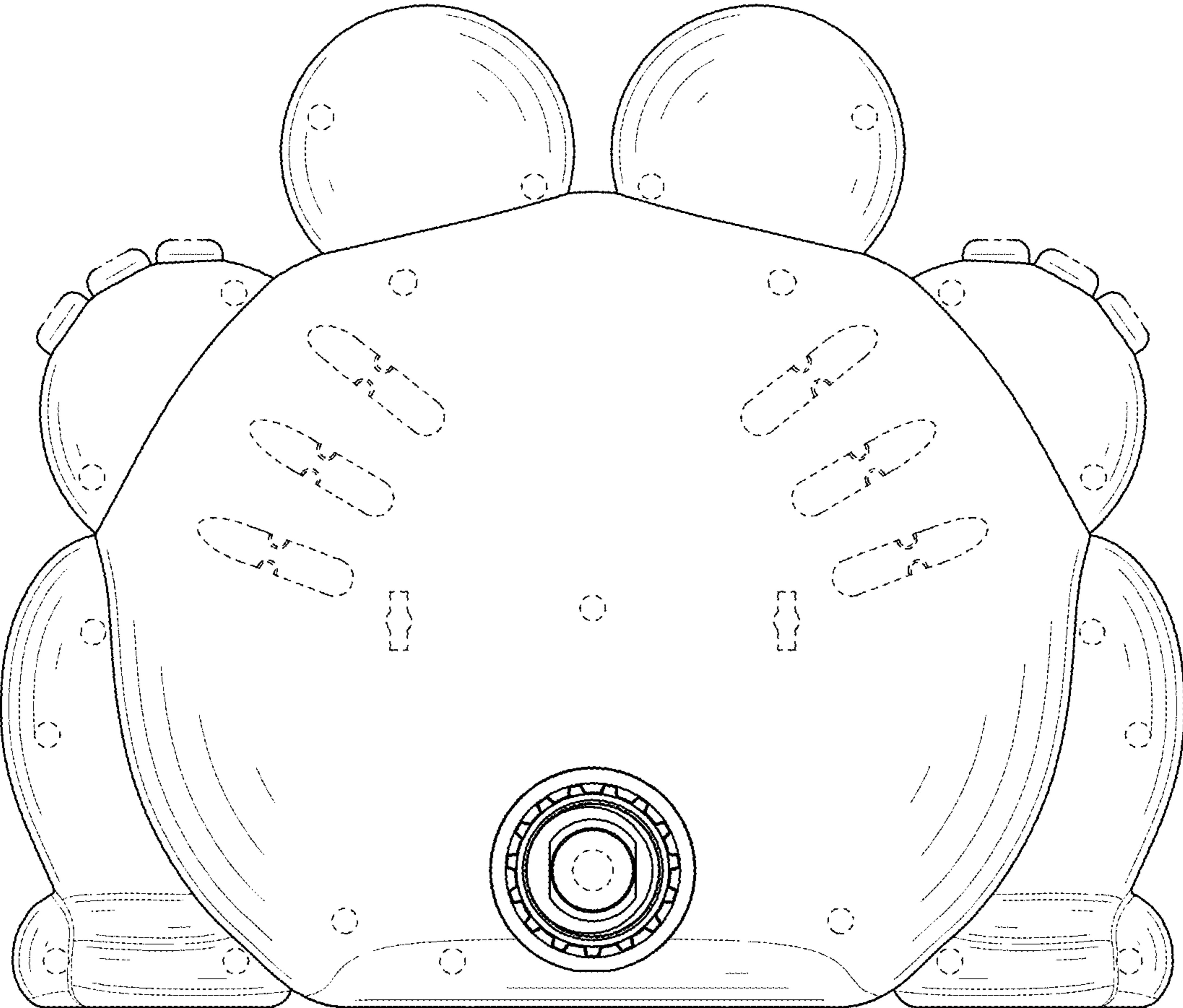

FIG. 4

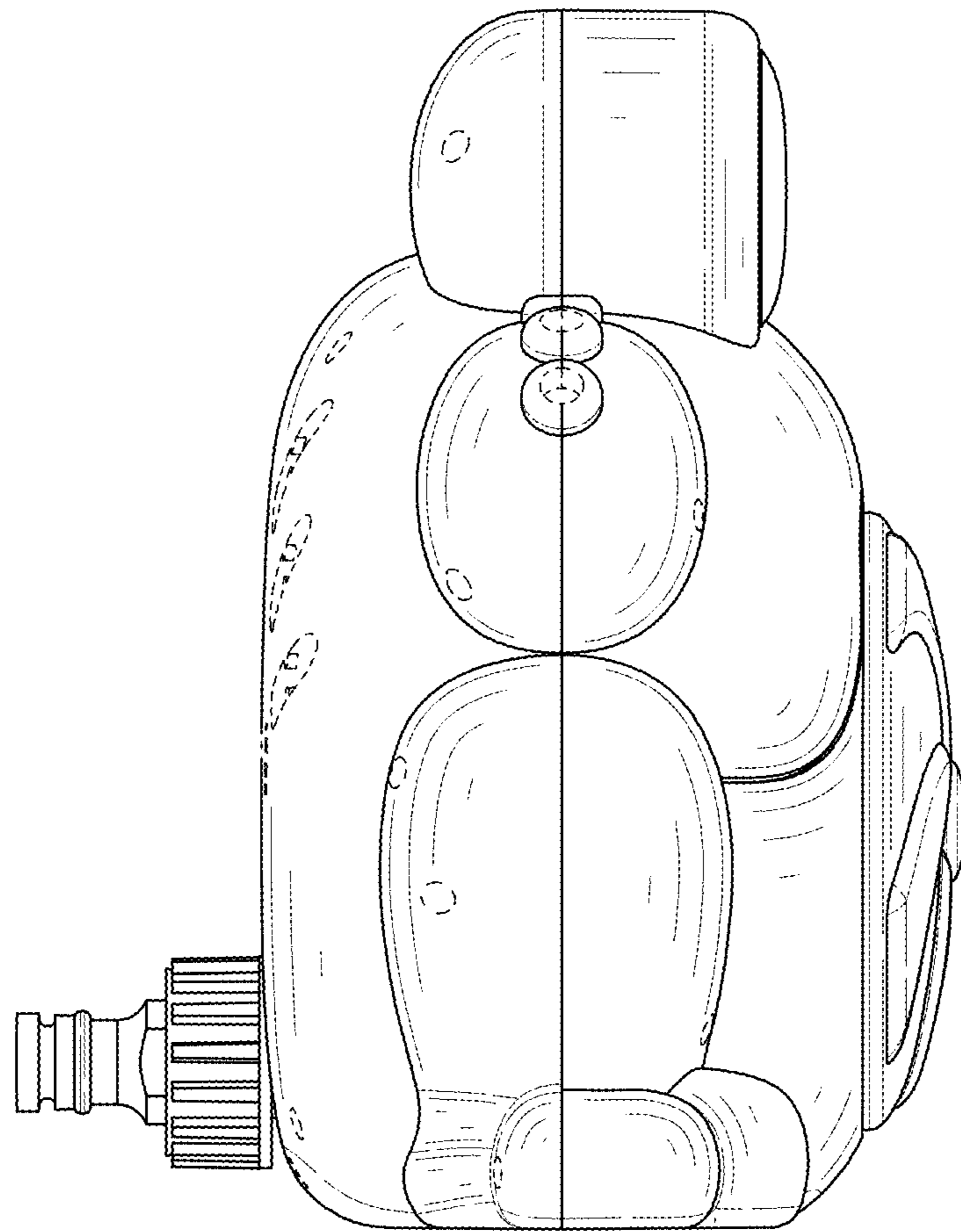

FIG. 5

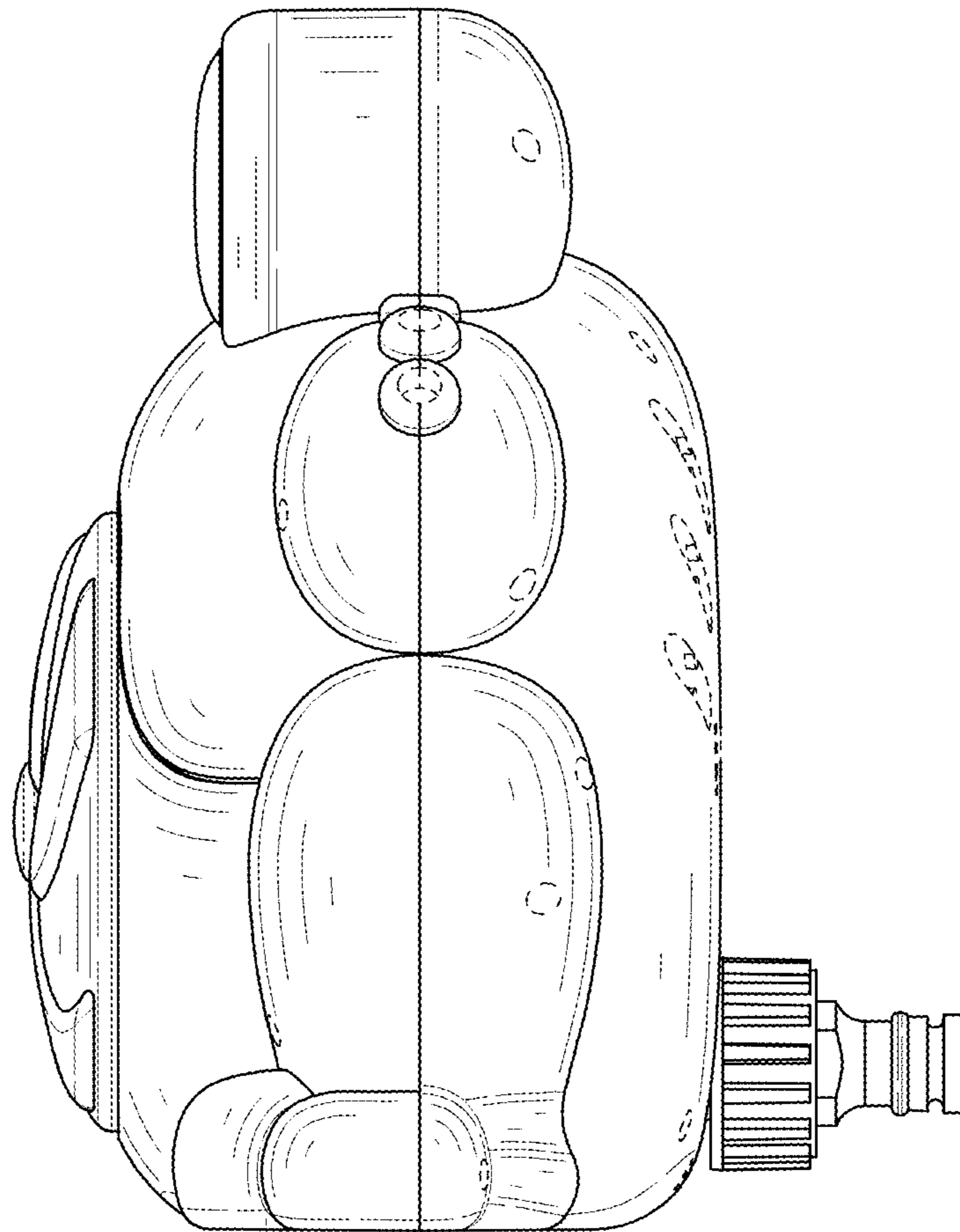

FIG. 6

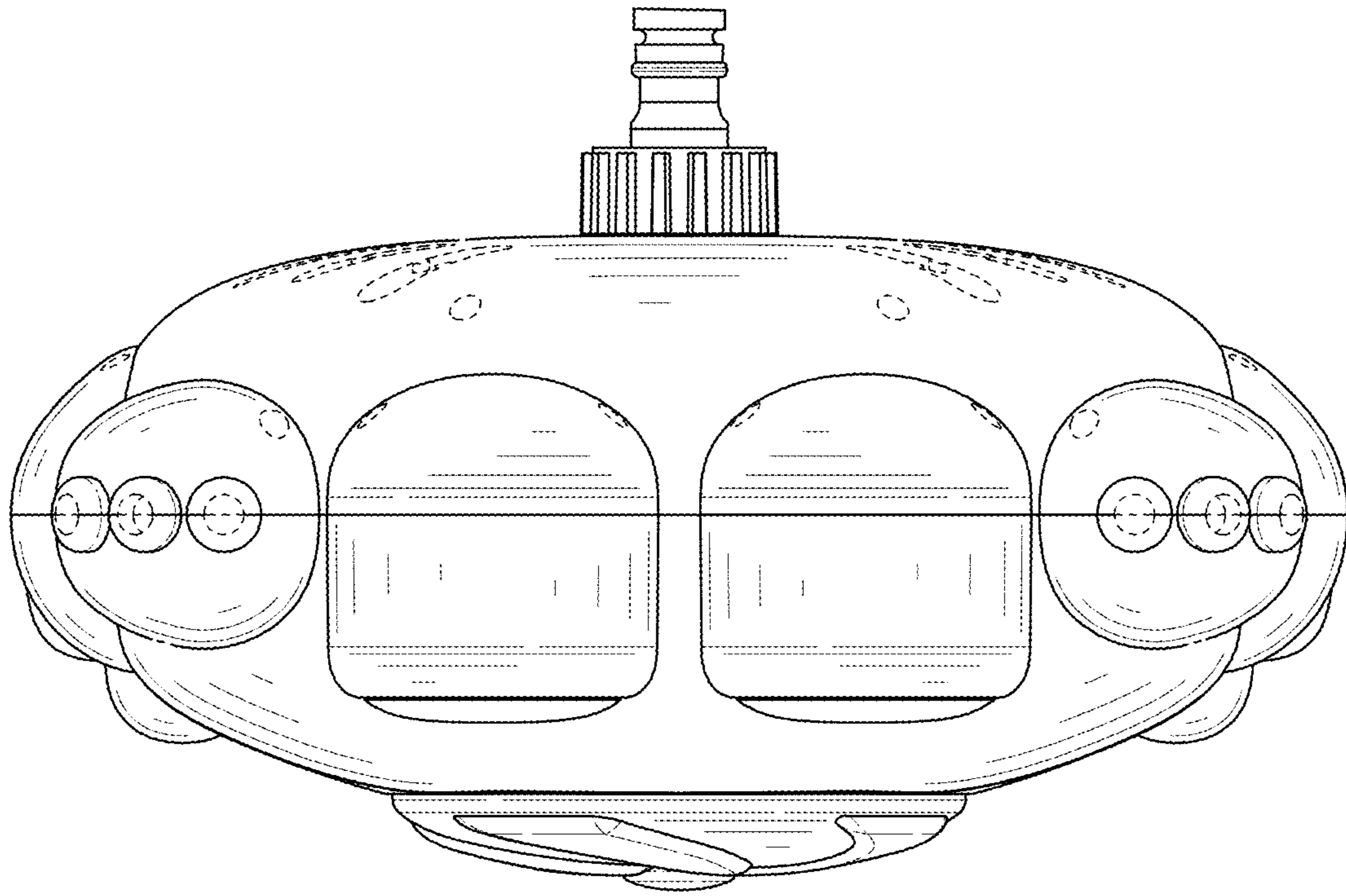

FIG. 7

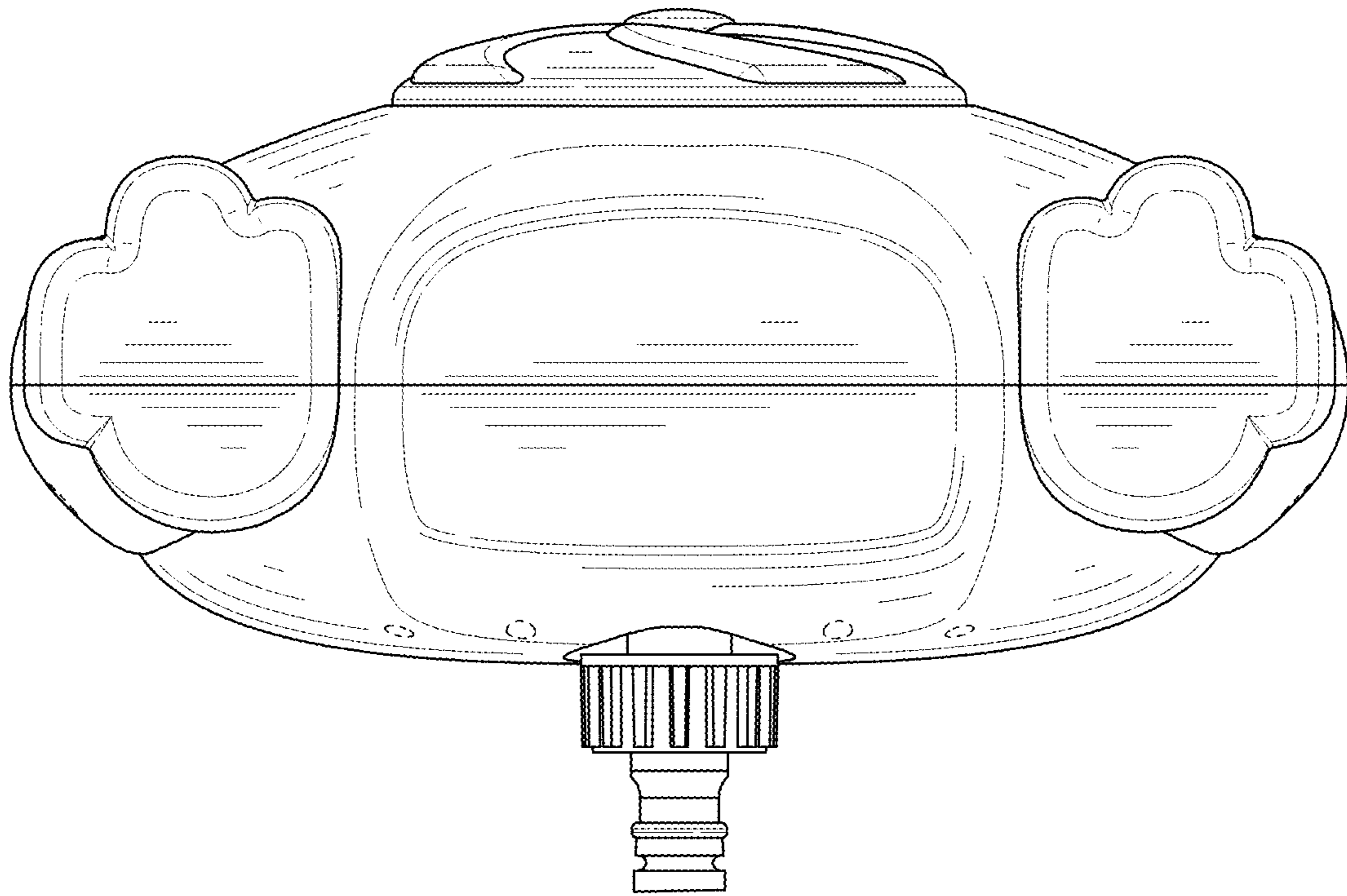

FIG. 8

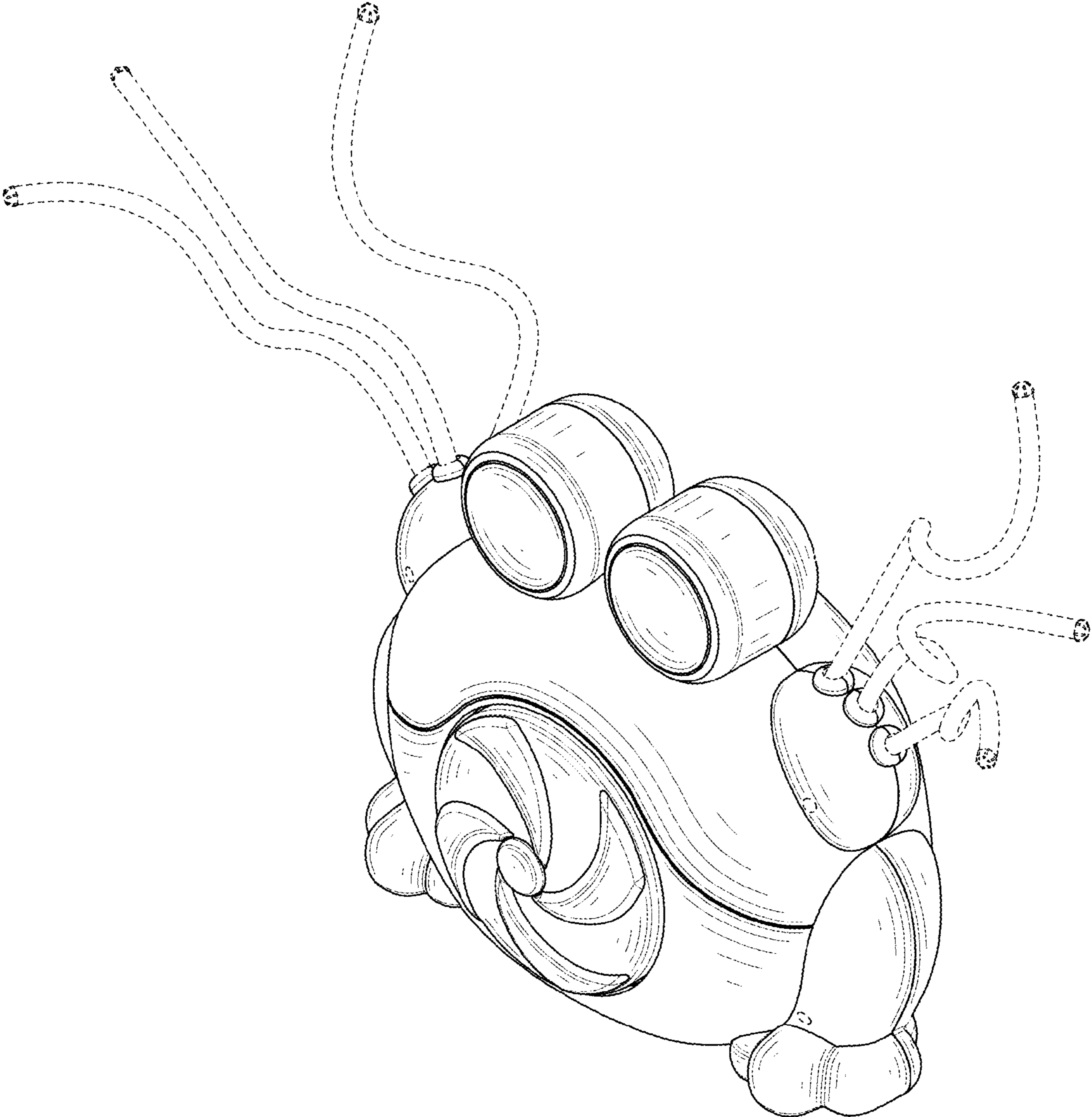

FIG. 9