

US00D960117S

(12) **United States Design Patent** (10) **Patent No.:** **US D960,117 S**
Wilcox et al. (45) **Date of Patent:** **** *Aug. 9, 2022**

(54) **OUTDOOR CABINET WITH SURFACE ORNAMENTATION**

(71) Applicant: **Corning Optical Communications LLC**, Hickory, NC (US)

(72) Inventors: **Dayne Wilcox**, Menlo Park, CA (US); **Lea Kobeli**, San Francisco, CA (US); **Marie Noury**, Croix (FR); **Marcelle Van Beusekom**, San Francisco, CA (US)

(73) Assignee: **Corning Optical Communications LLC**, Charlotte, NC (US)

(*) Notice: This patent is subject to a terminal disclaimer.

(**) Term: **15 Years**

(21) Appl. No.: **29/577,606**

(22) Filed: **Sep. 14, 2016**

(51) **LOC (13) Cl.** **13-03**

(52) **U.S. Cl.**
USPC **D13/184**

(58) **Field of Classification Search**
USPC D13/184, 131, 132, 133; D14/353, 441, D14/440, 444, 181; 385/135
(Continued)

(56) **References Cited**

U.S. PATENT DOCUMENTS

D81,554 S 7/1930 Scharf
2,344,302 A * 3/1944 Harza E02B 3/14
405/16

(Continued)

FOREIGN PATENT DOCUMENTS

GB 2055955 9/1995
GB 4023637 2/2012

(Continued)

OTHER PUBLICATIONS

Corning, OptiTect Indoor CE Cabinet, Family Spec Sheet, 2015, 1-8, Corning Optical Communications LLC.

(Continued)

Primary Examiner — Janice Hallmark

Assistant Examiner — Harold E Blackwell, II

(74) *Attorney, Agent, or Firm* — Adam R. Weeks

(57) **CLAIM**

The ornamental design for outdoor cabinet with surface ornamentation, as shown and described.

DESCRIPTION

FIG. 1 is a front perspective view of an outdoor cabinet with surface ornamentation illustrating an embodiment of our new design;

FIG. 2 is a front view thereof;

FIG. 3 is a rear view thereof;

FIG. 4 is a left view thereof;

FIG. 5 is a right view thereof;

FIG. 6 is a top view thereof; and

FIG. 7 is a bottom view thereof;

FIG. 8 is a front perspective view of an outdoor cabinet with surface ornamentation illustrating an embodiment of our new design;

FIG. 9 is a front view thereof;

FIG. 10 is a rear view thereof;

FIG. 11 is a left view thereof;

FIG. 12 is a right view thereof;

FIG. 13 is a top view thereof; and

FIG. 14 is a bottom view thereof;

FIG. 15 is a front perspective view of an outdoor cabinet with surface ornamentation illustrating another embodiment of our new design;

FIG. 16 is a front view thereof;

FIG. 17 is a rear view thereof;

FIG. 18 is a left view thereof;

FIG. 19 is a right view thereof;

FIG. 20 is a top view thereof; and

FIG. 21 is a bottom view thereof.

(Continued)

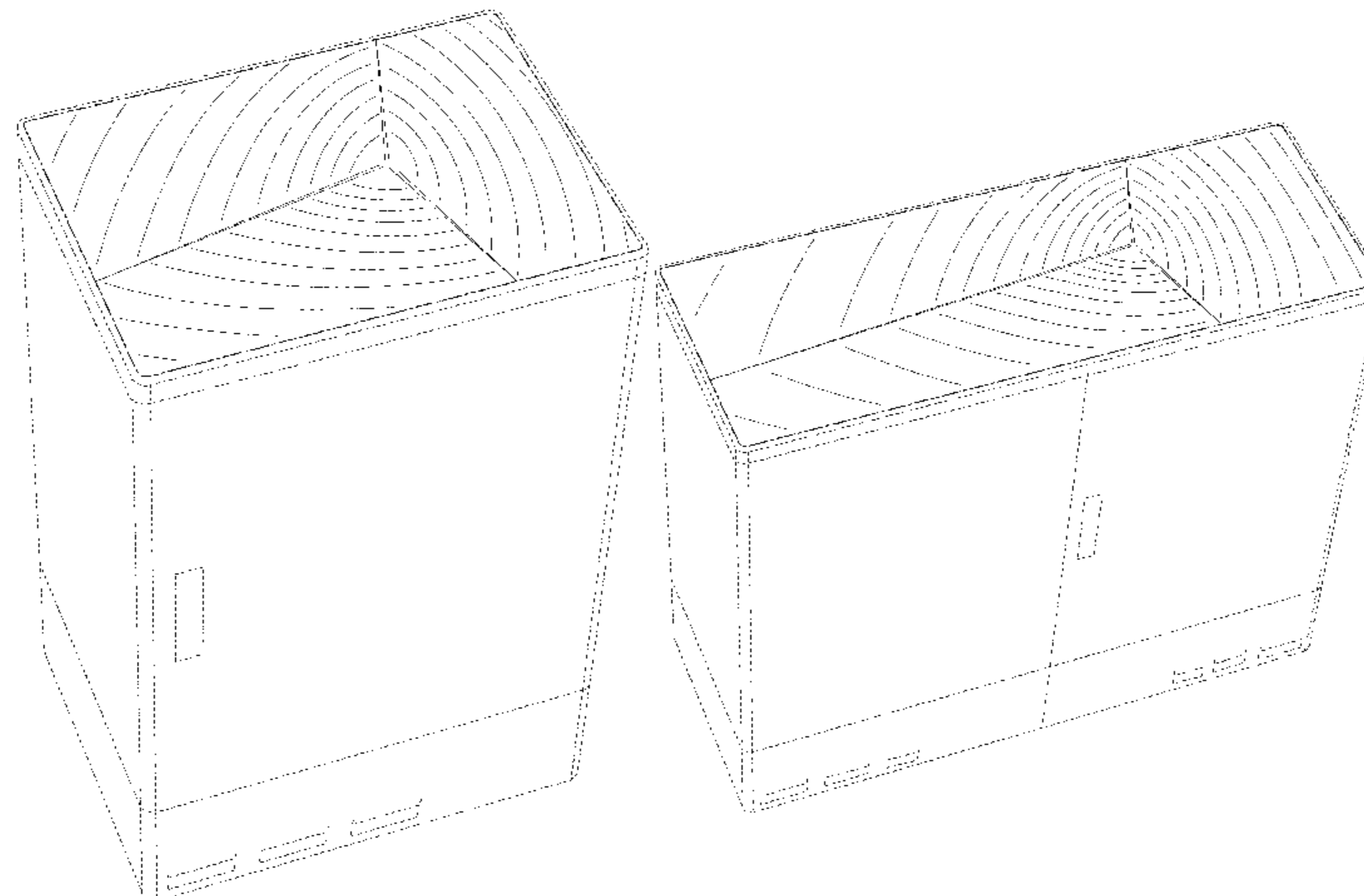

FIG. 22 is a front perspective view of an outdoor cabinet with surface ornamentation illustrating another embodiment of our new design;
 FIG. 23 is a front view thereof;
 FIG. 24 is a rear view thereof;
 FIG. 25 is a left view thereof;
 FIG. 26 is a right view thereof;
 FIG. 27 is a top view thereof; and,
 FIG. 28 is a bottom view thereof.

The dash-dash broken lines in the drawings are included for the purpose of illustrating portions of the outdoor cabinet with surface ornamentation and the dash-dot-dash broken lines in the drawings depict the bounds of the claimed design. All broken lines form no part of the claimed design.

1 Claim, 22 Drawing Sheets

(58) **Field of Classification Search**

CPC G02B 6/4463; G02B 6/443; G02B 6/44
 See application file for complete search history.

(56) **References Cited**

U.S. PATENT DOCUMENTS

D165,559	S	12/1951	Spence	
D208,054	S	7/1967	Mulder et al.	
4,362,432	A *	12/1982	Conover	E02B 3/06 405/33
4,458,936	A *	7/1984	Mulholland	B62D 35/001 296/180.4
4,698,727	A	10/1987	Hibbert et al.	
D403,888	S	1/1999	Hutton	
D403,894	S	1/1999	Hutton	
D418,114	S	12/1999	Hayduke et al.	
6,133,531	A	10/2000	Hayduke et al.	
D433,418	S *	11/2000	Newman	D14/444
D436,945	S *	1/2001	Tanaka	D14/214

6,467,833	B1 *	10/2002	Travers	B62D 35/004 296/180.1
D514,849	S	2/2006	Dortch	
D528,537	S *	9/2006	Wang	D14/230
7,346,253	B2 *	3/2008	Bloodworth	G02B 6/4453 385/134
D595,292	S *	6/2009	Harden	D14/240
D646,954	S	10/2011	Azelton et al.	
D705,555	S	5/2014	Adjaye	
D724,079	S *	3/2015	Probst	D14/348
D782,536	S *	3/2017	Chu	D14/203.3
D791,774	S *	7/2017	Wilcox	D14/444
D795,079	S *	8/2017	Wilcox	D9/703
D802,415	S *	11/2017	Wilcox	D9/432
D815,642	S *	4/2018	Wilcox	D14/441
D818,952	S *	5/2018	Wilcox	D13/110
D821,325	S *	6/2018	Duran	D13/124
D824,333	S *	7/2018	Wilcox	D13/133
D824,335	S *	7/2018	Wilcox	D13/147
D824,337	S *	7/2018	Wilcox	D13/147

FOREIGN PATENT DOCUMENTS

GB	4023638	2/2012
GB	4023639	2/2012

OTHER PUBLICATIONS

Corning, OptiTect Indoor Local Convergence Cabinet, Gen III Series, Family Spec Sheet, 2015, 1-8, Corning Optical Communications LLC.
 Corning, Wall-Mountable Building Terminal (WBT), Family Spec Sheet, 2016, 1-3, Corning Optical Communications LLC.
 Corning, OptiTect Indoor Local Convergence Cabinet, LS Series, Family Spec Sheet, 2016, 1-7, Corning Optical Communications LLC.
 Corning, LS Series Outdoor Cabinets, Family Spec Sheet, 2016, 3-9, Corning Optical Communications LLC.
<https://www.youtube.com/watch?v=XUNYr-XAbVc>, Jul. 20, 2016.

* cited by examiner

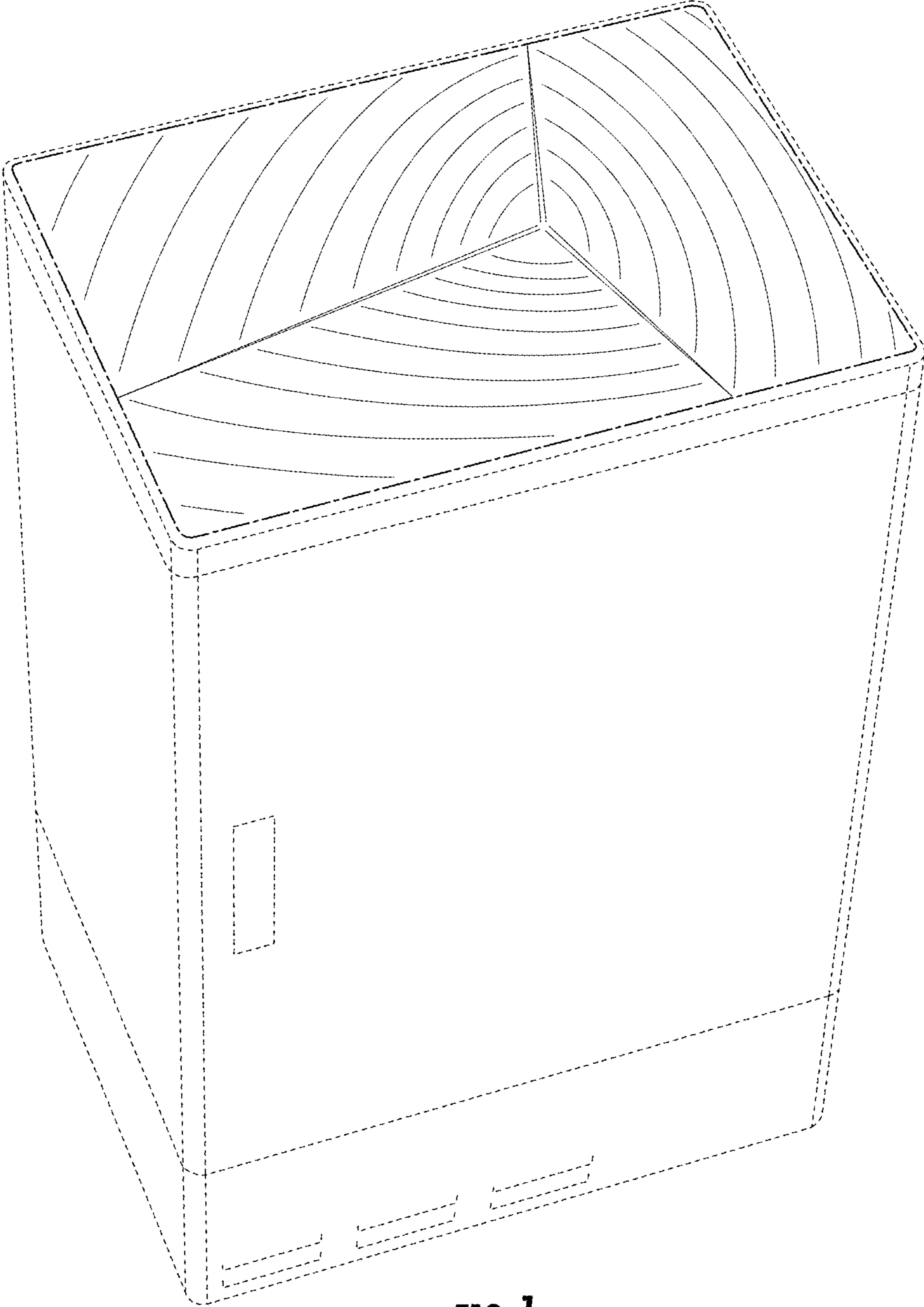

FIG. 1

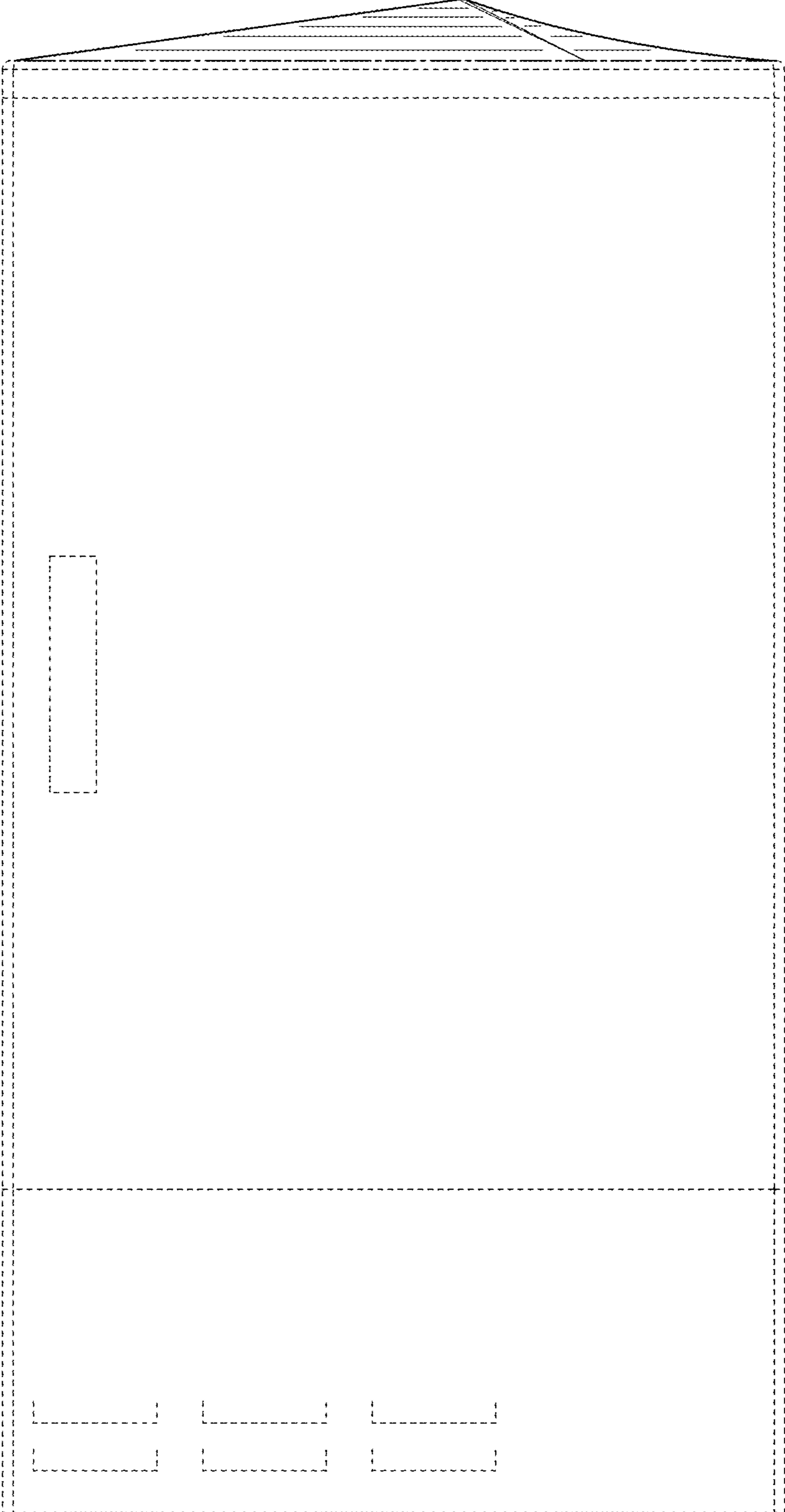

FIG. 2



FIG. 3

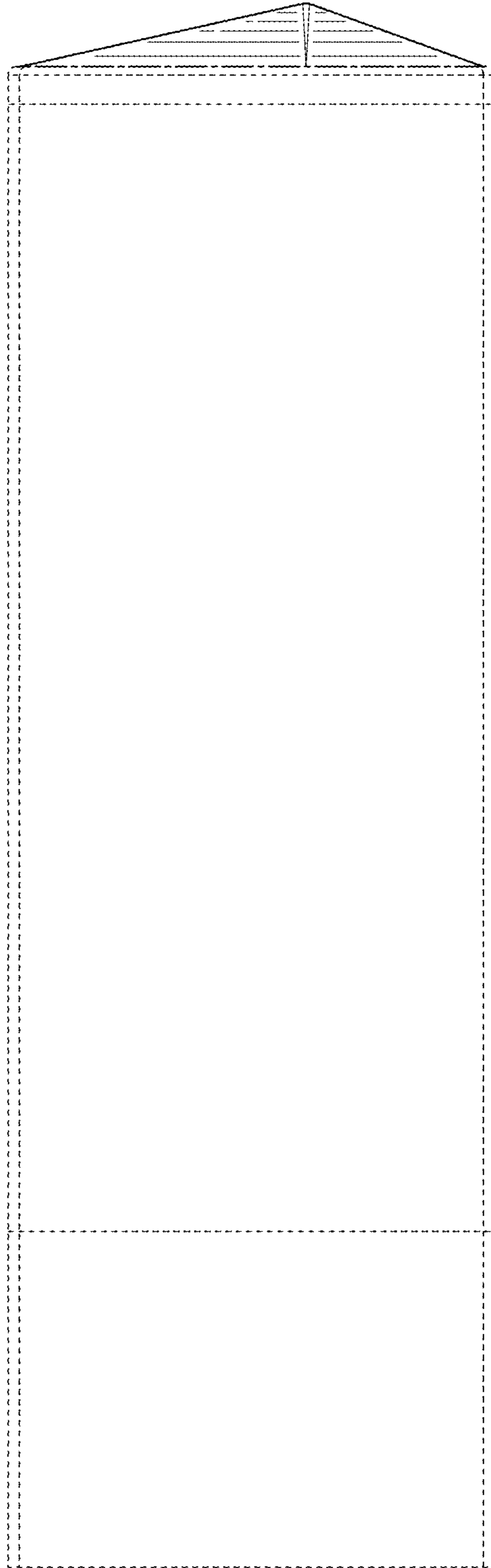

FIG. 4

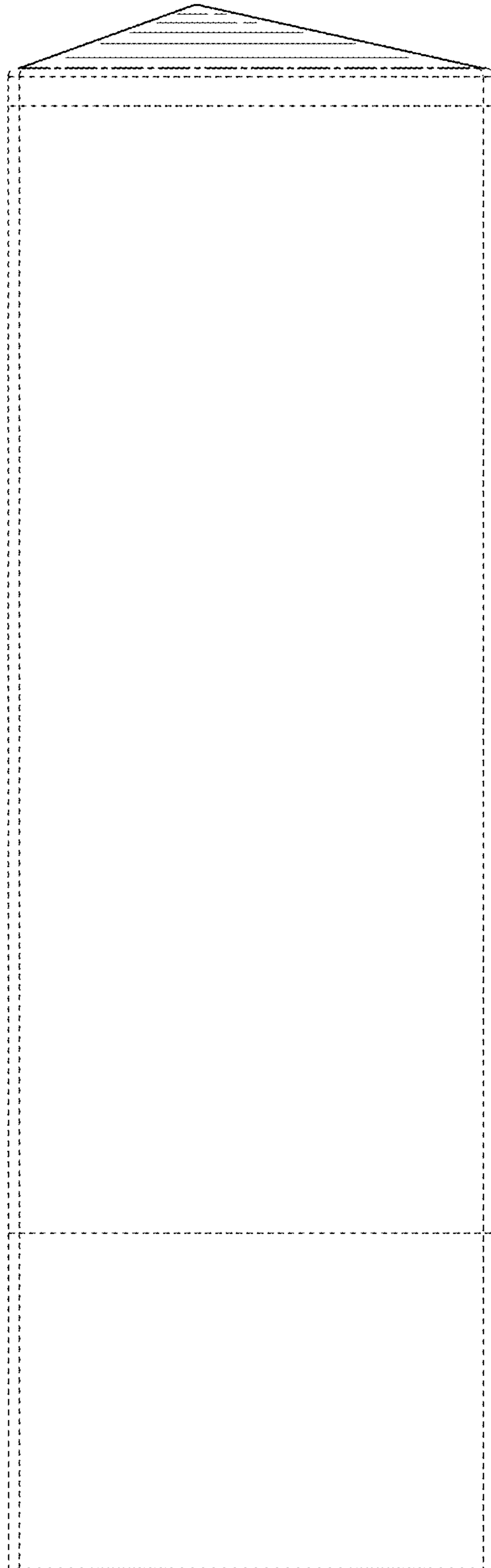

FIG. 5

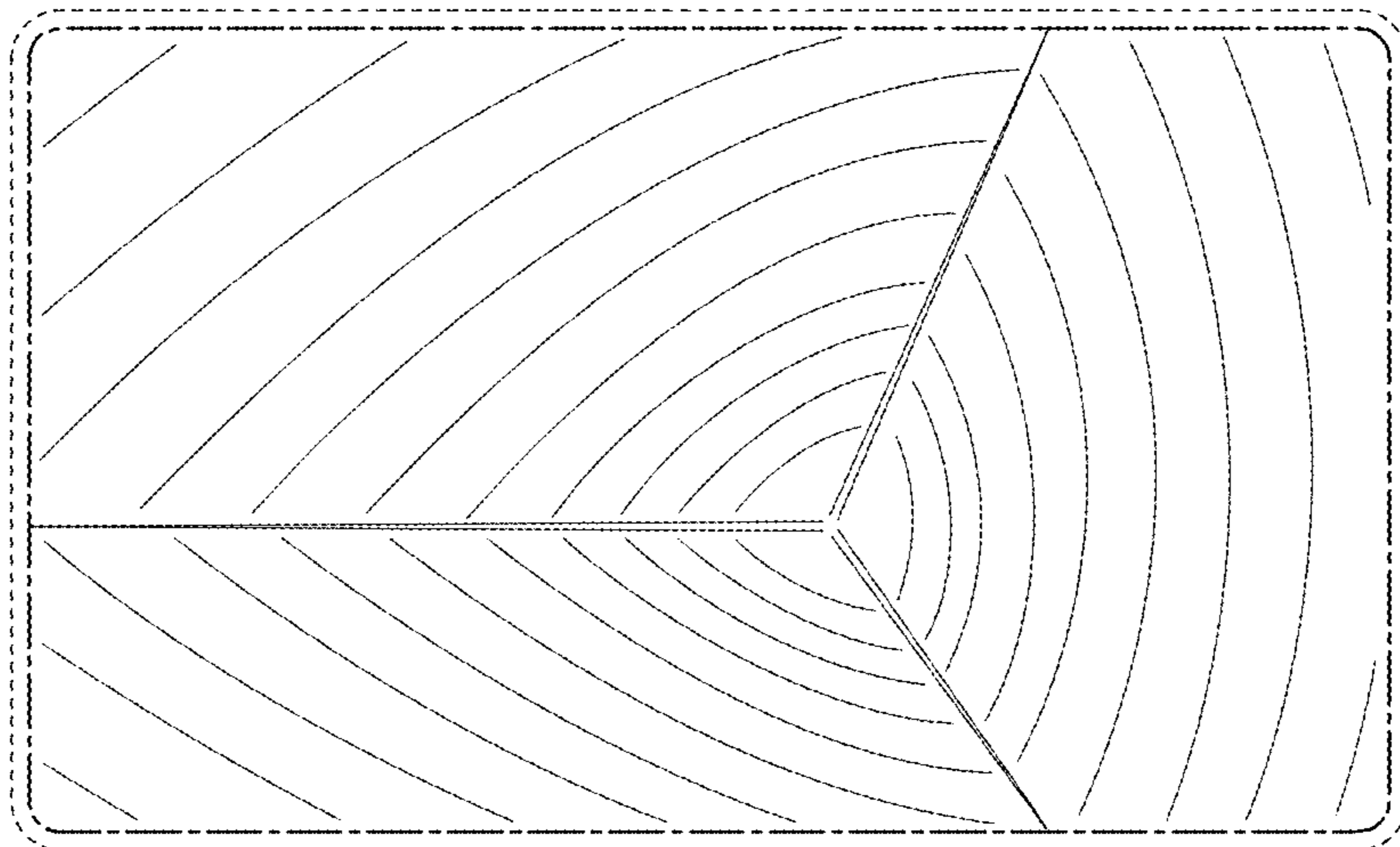

FIG. 6



FIG. 7

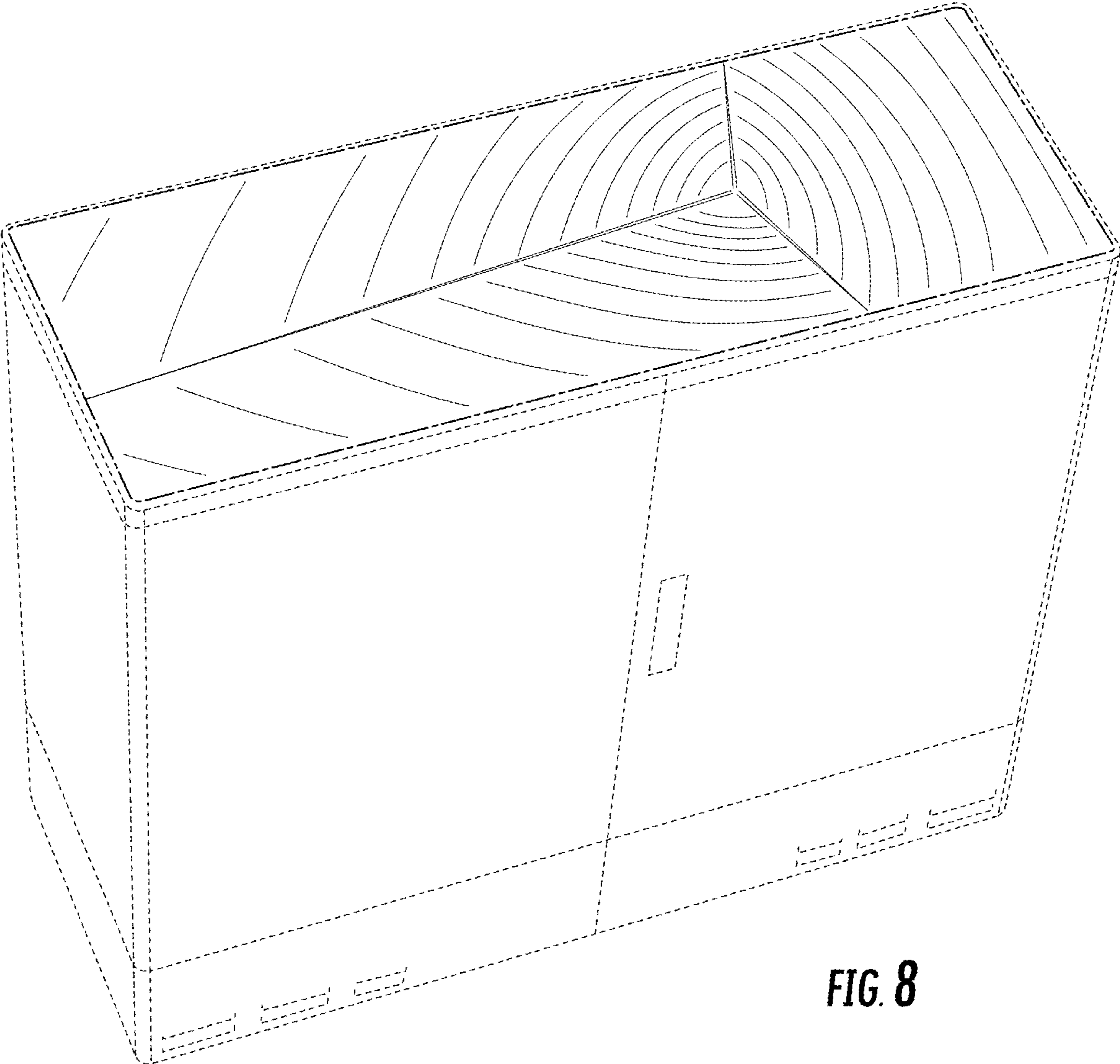

FIG. 8

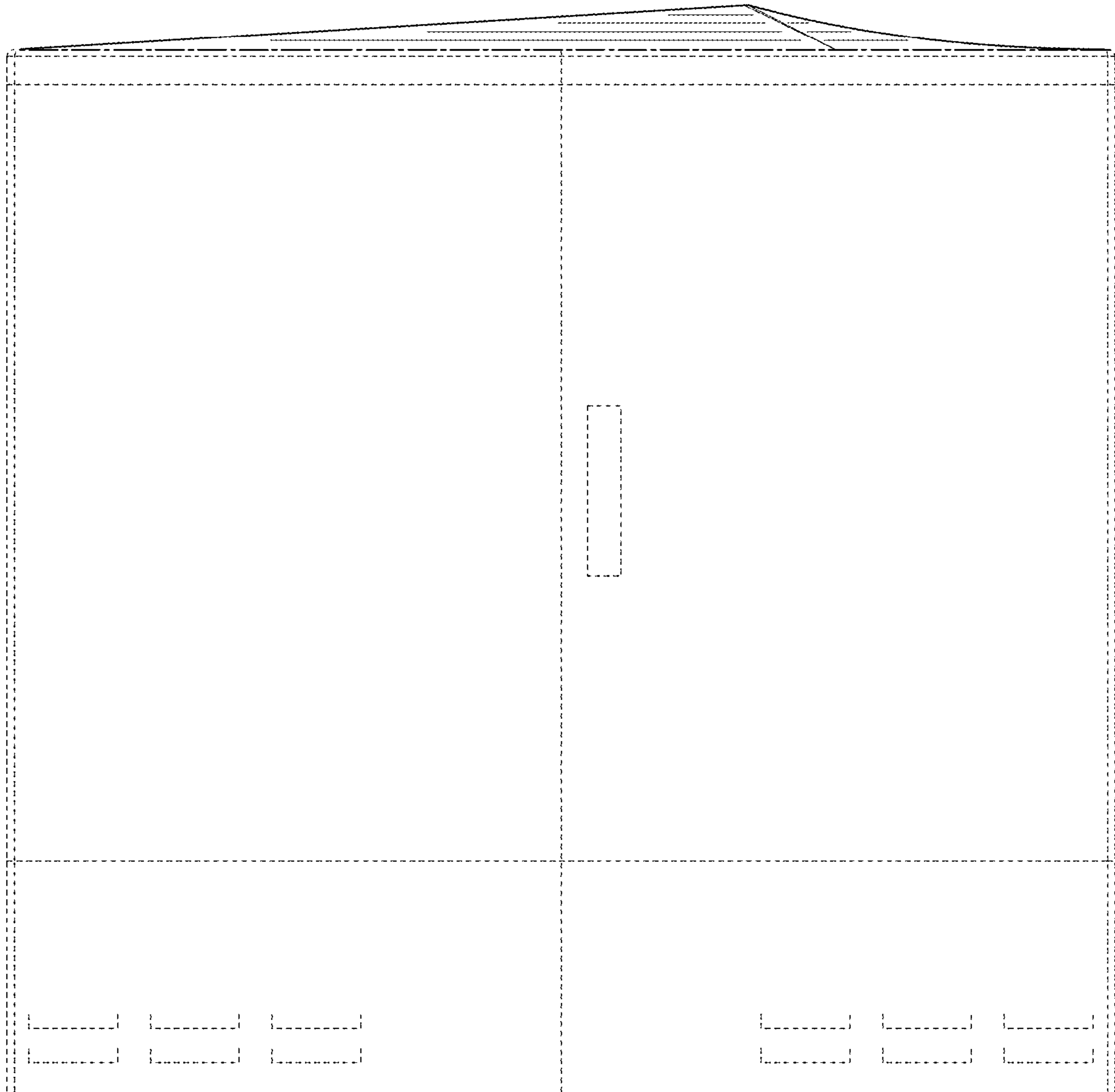

FIG. 9

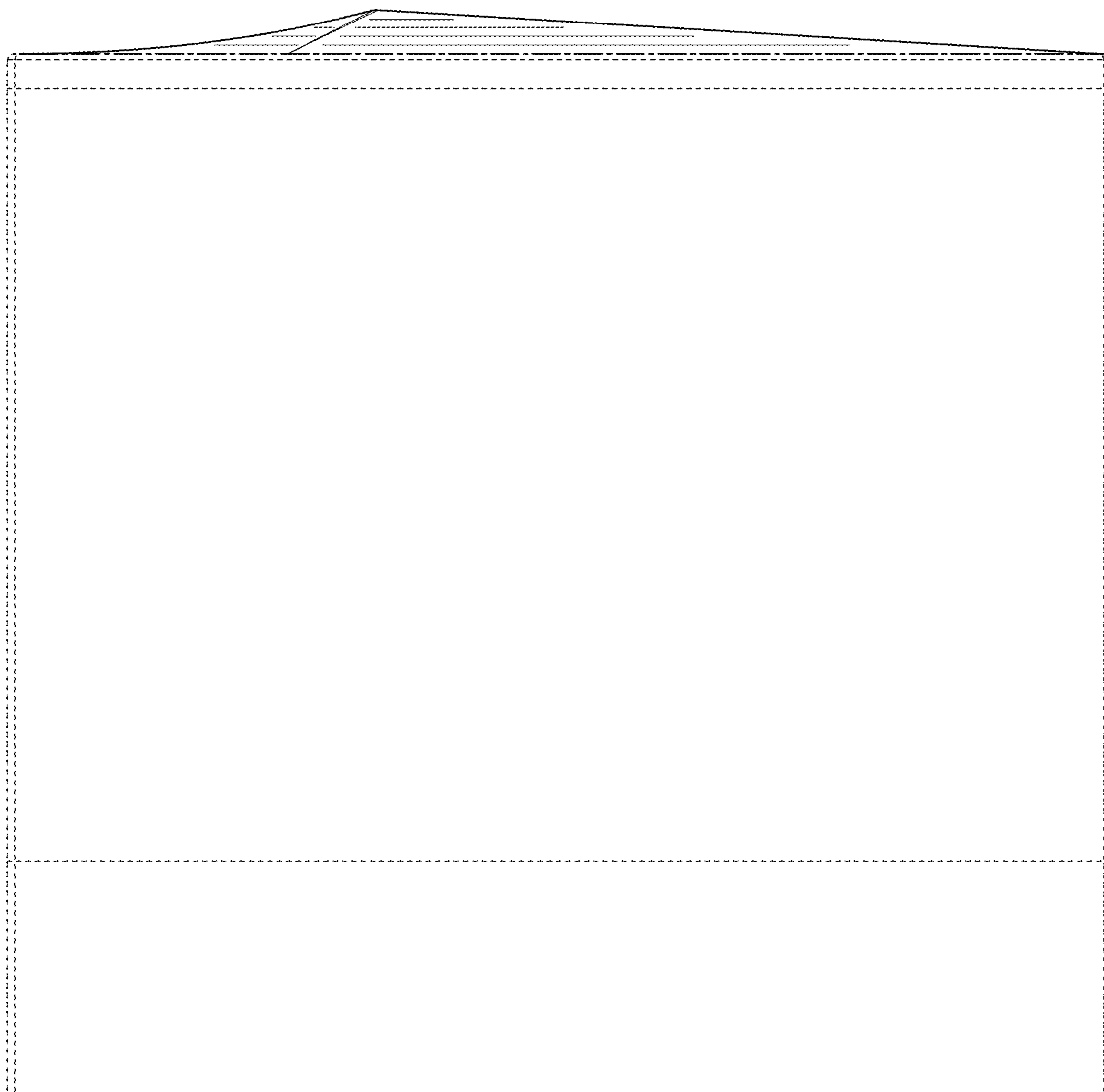

FIG. 10



FIG. 12



FIG. 11

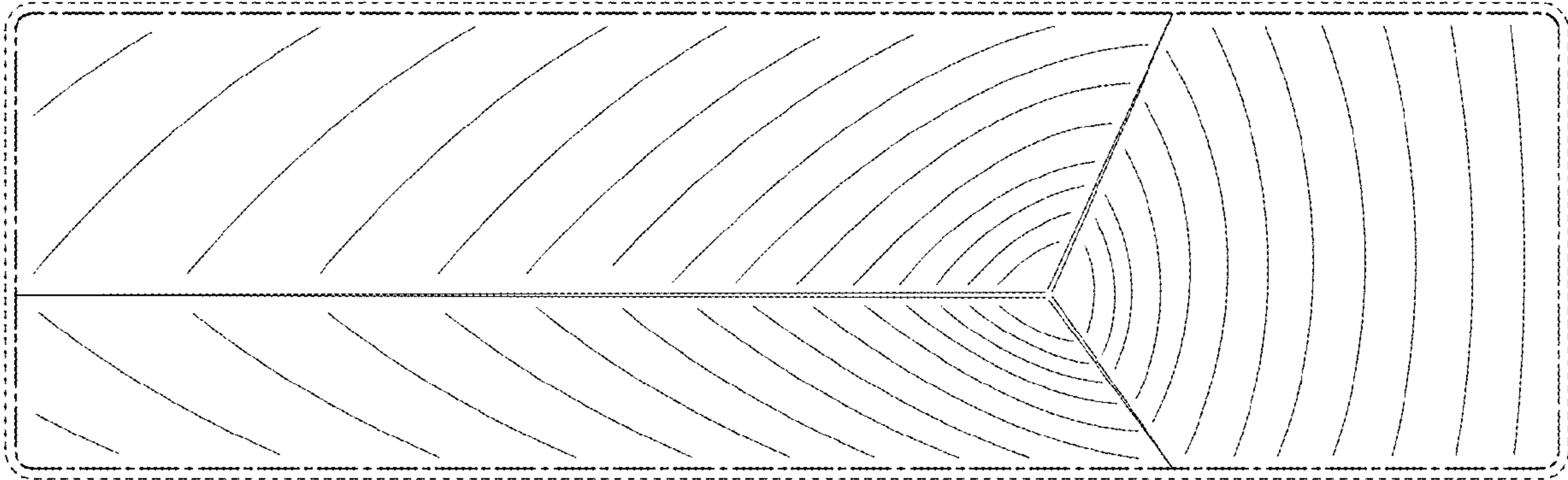

FIG. 13



FIG. 14

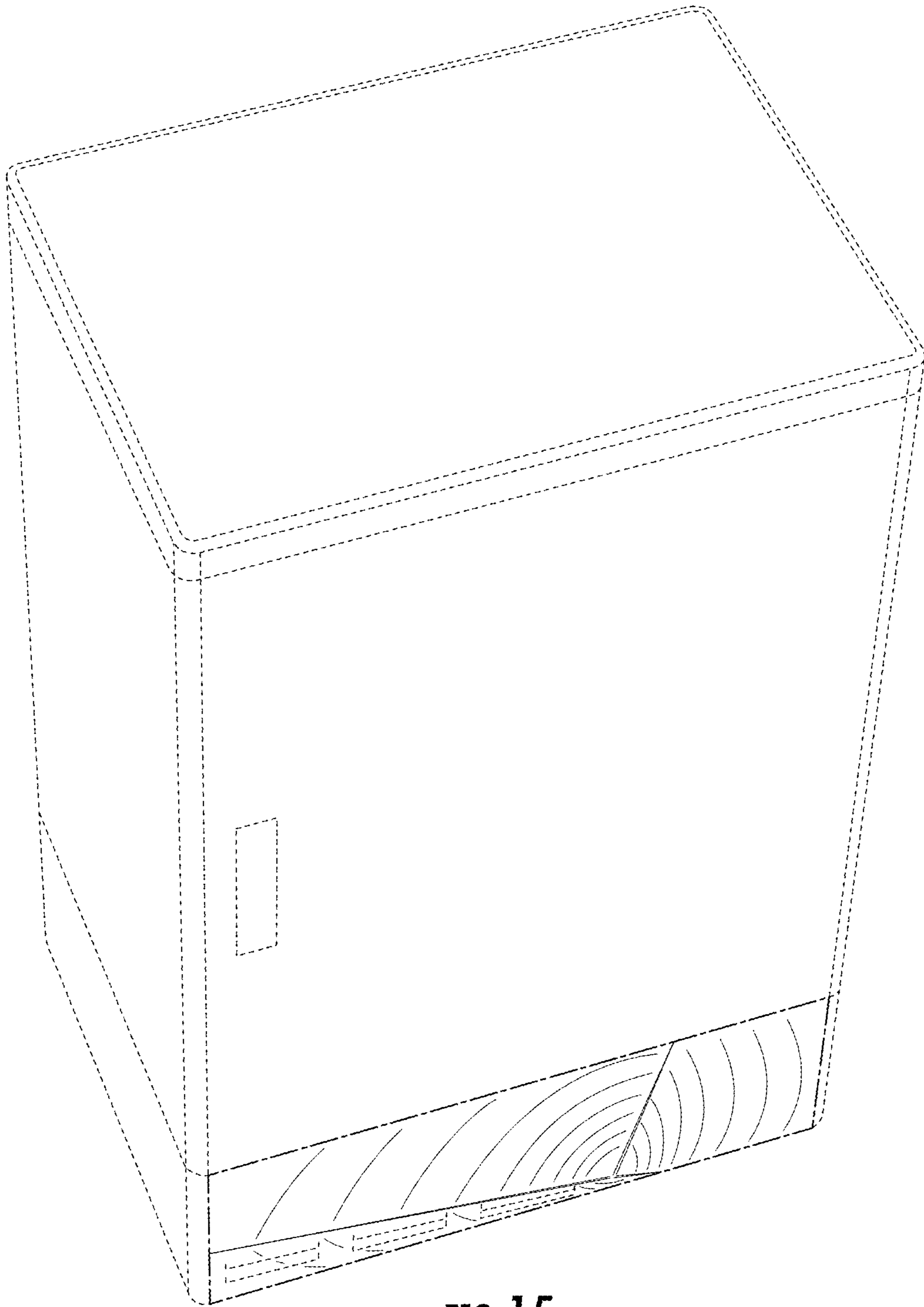

FIG. 15

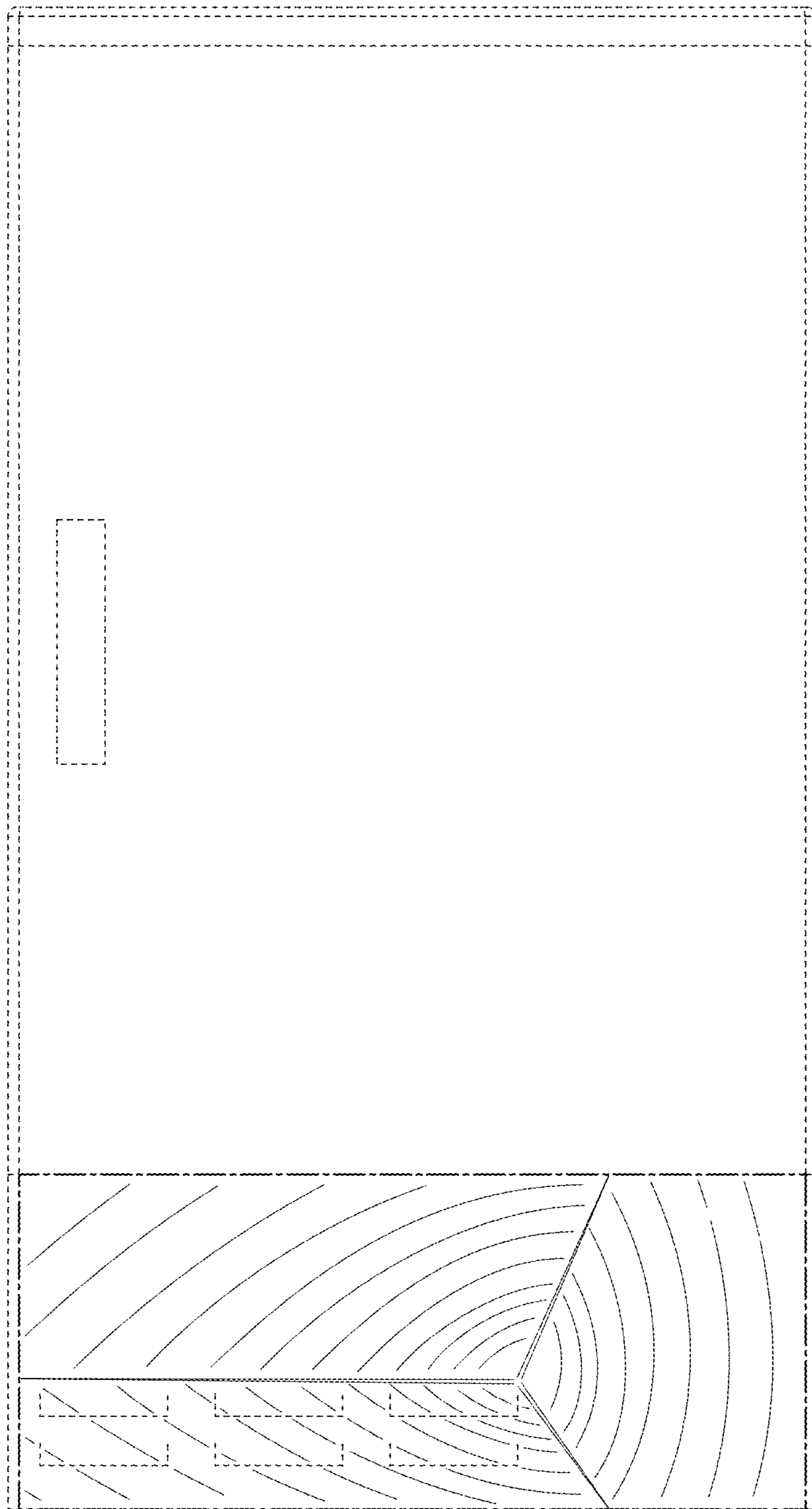

FIG. 16



FIG. 17

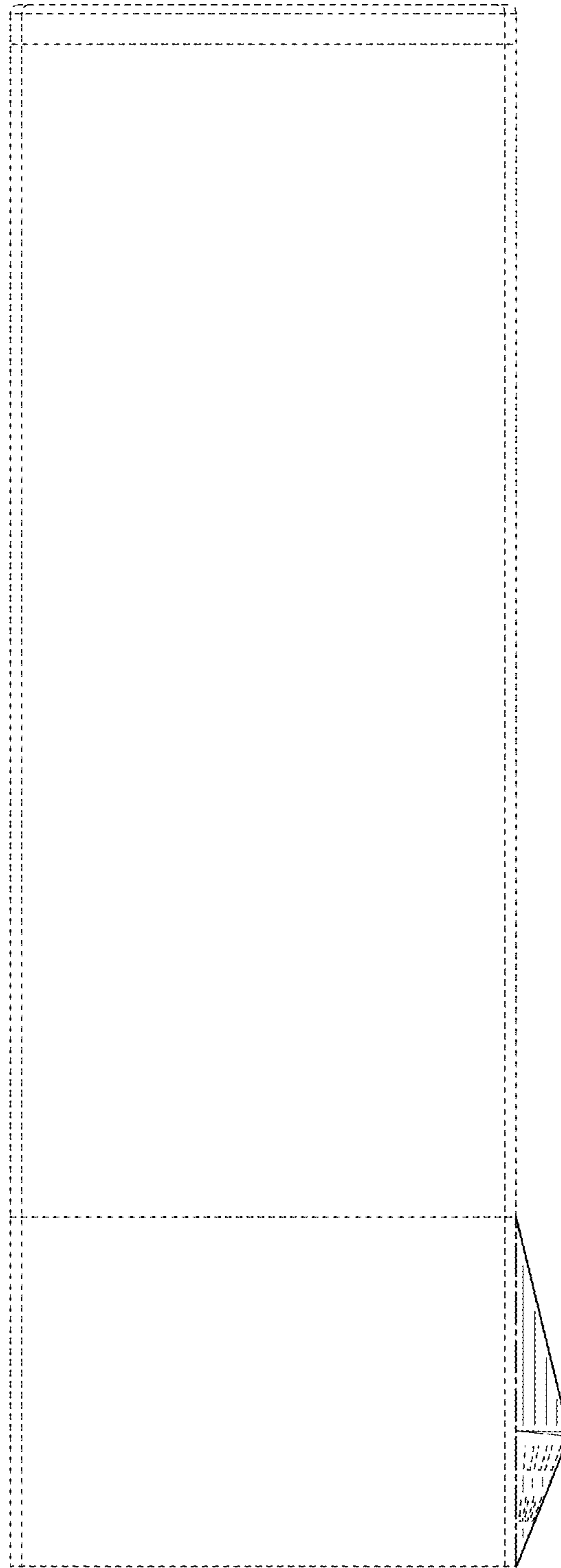

FIG. 18

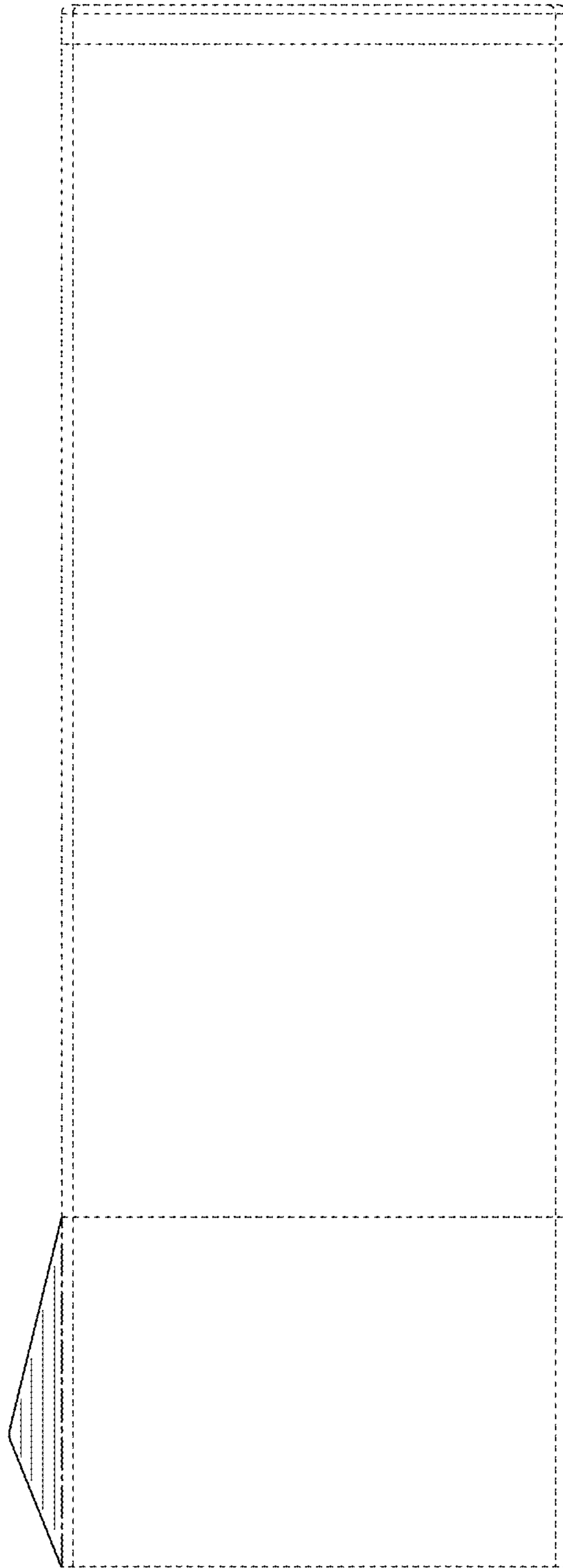

FIG. 19

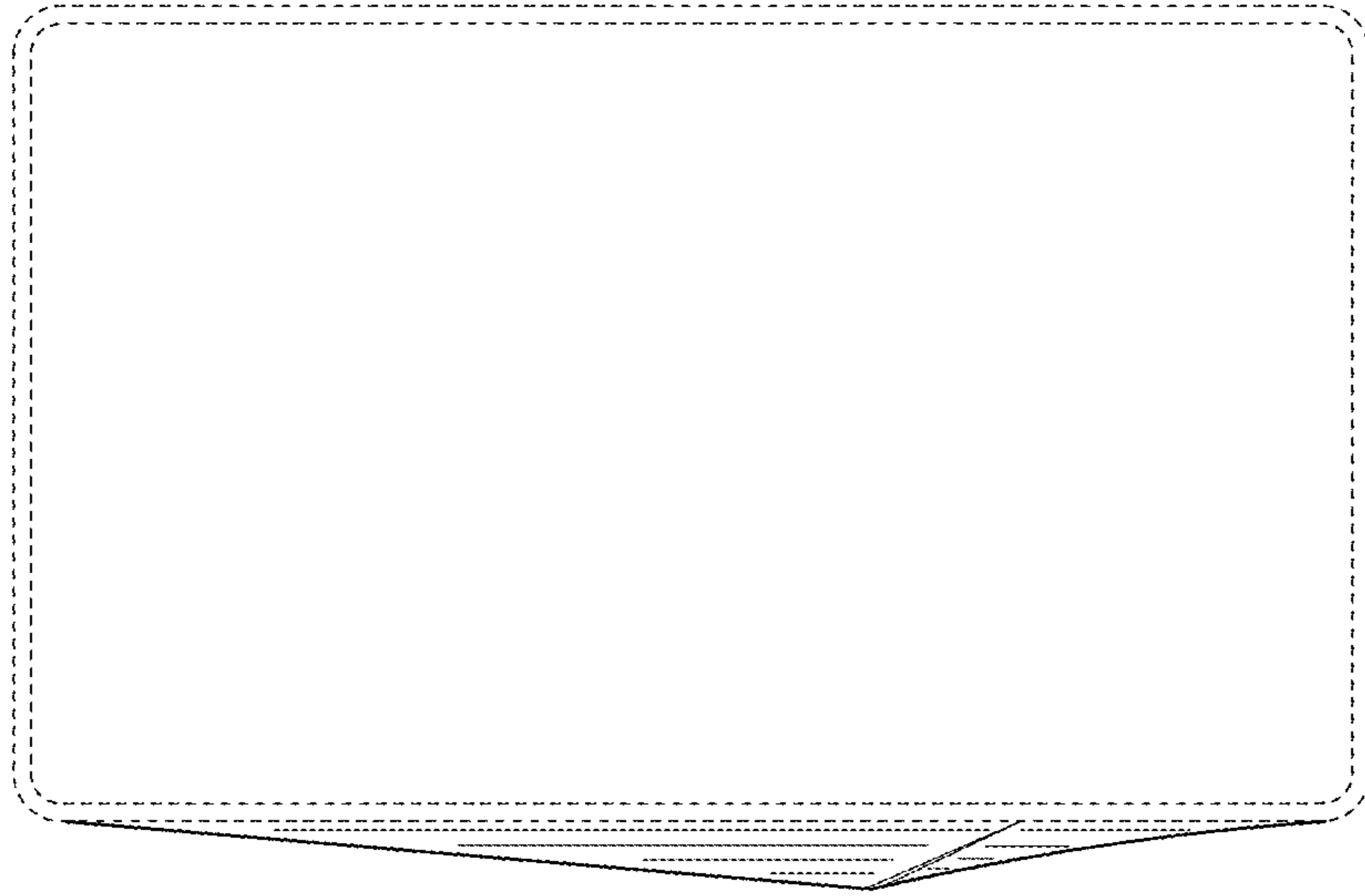

FIG. 20

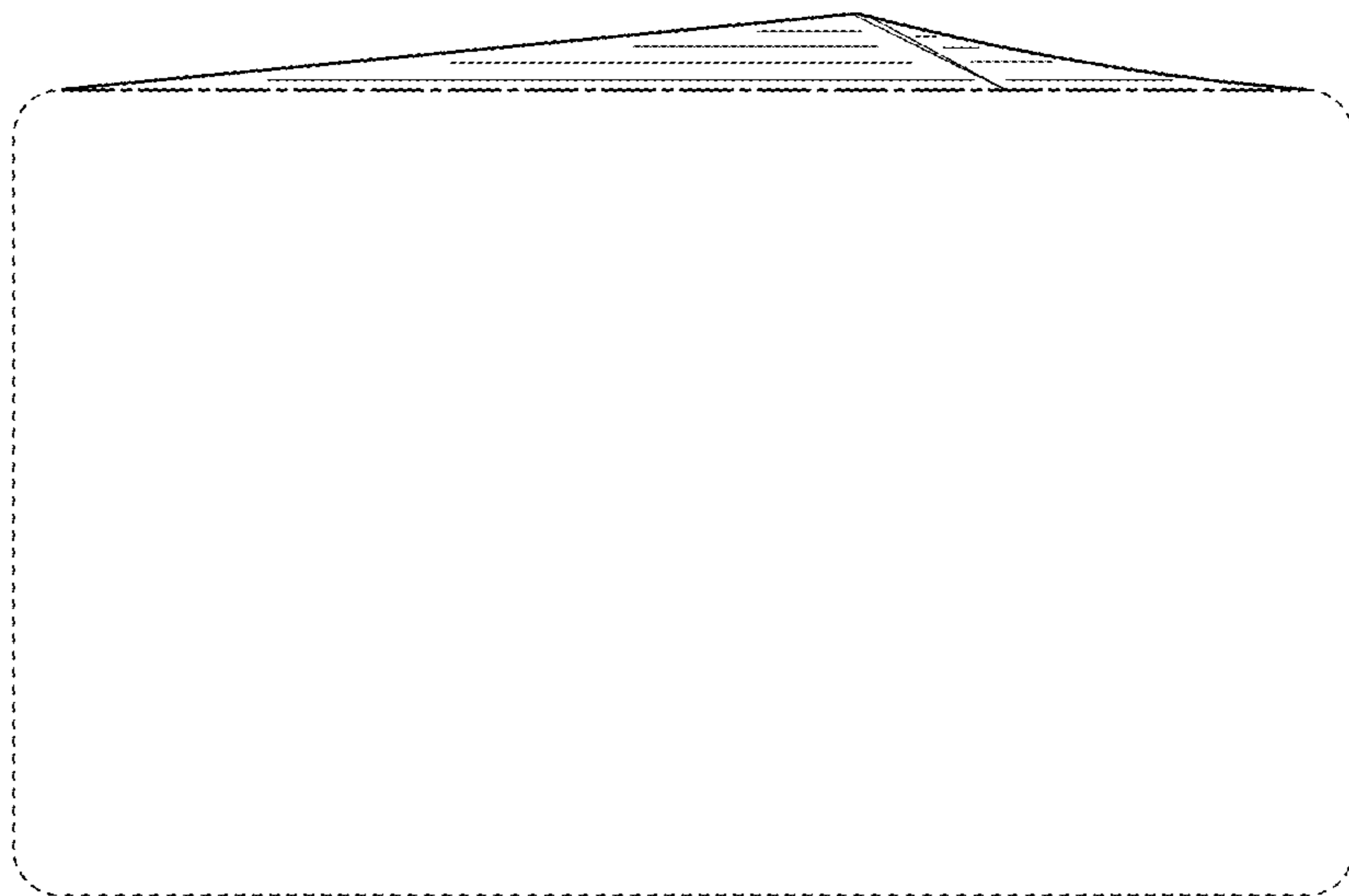

FIG. 21

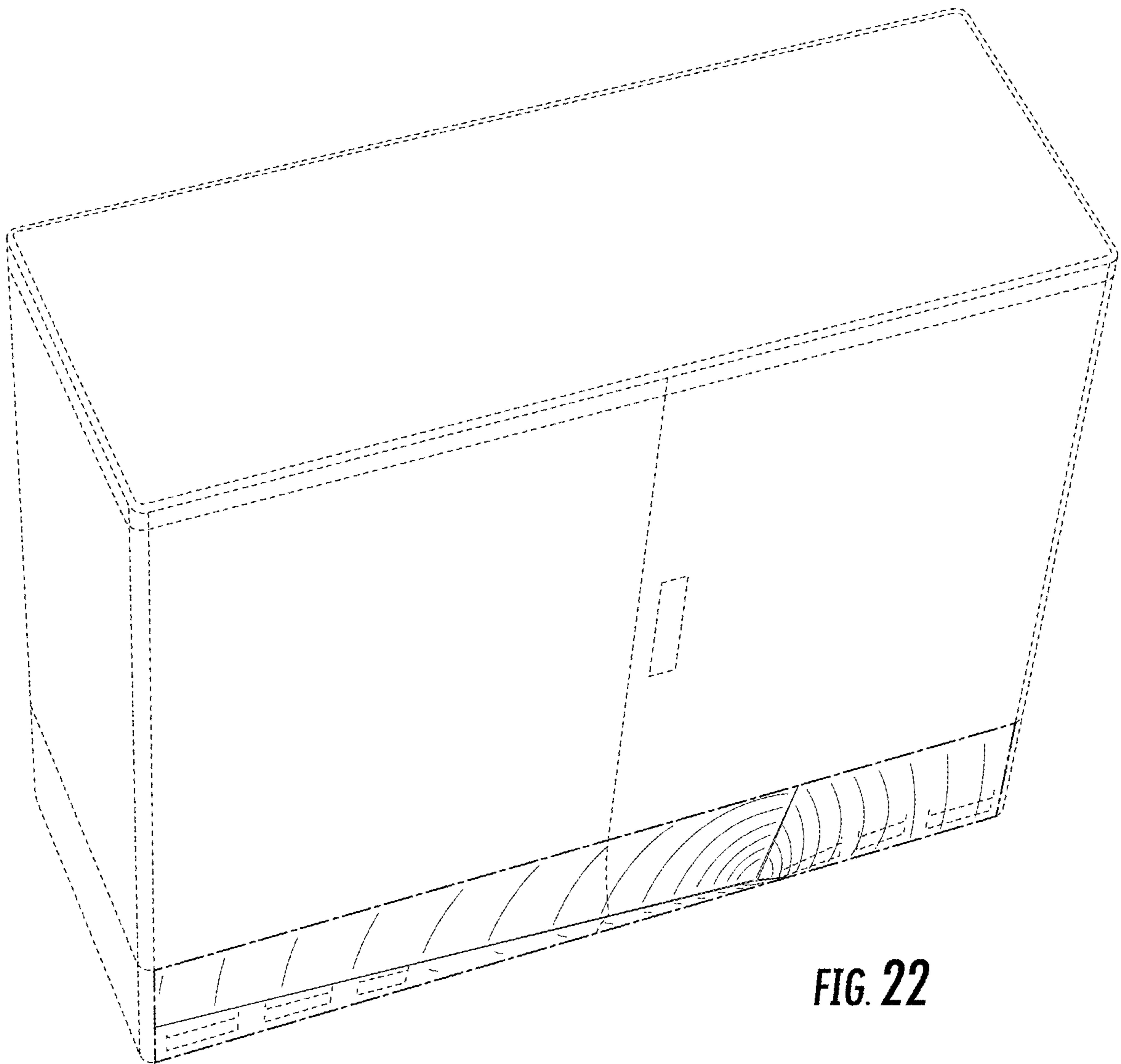

FIG. 22

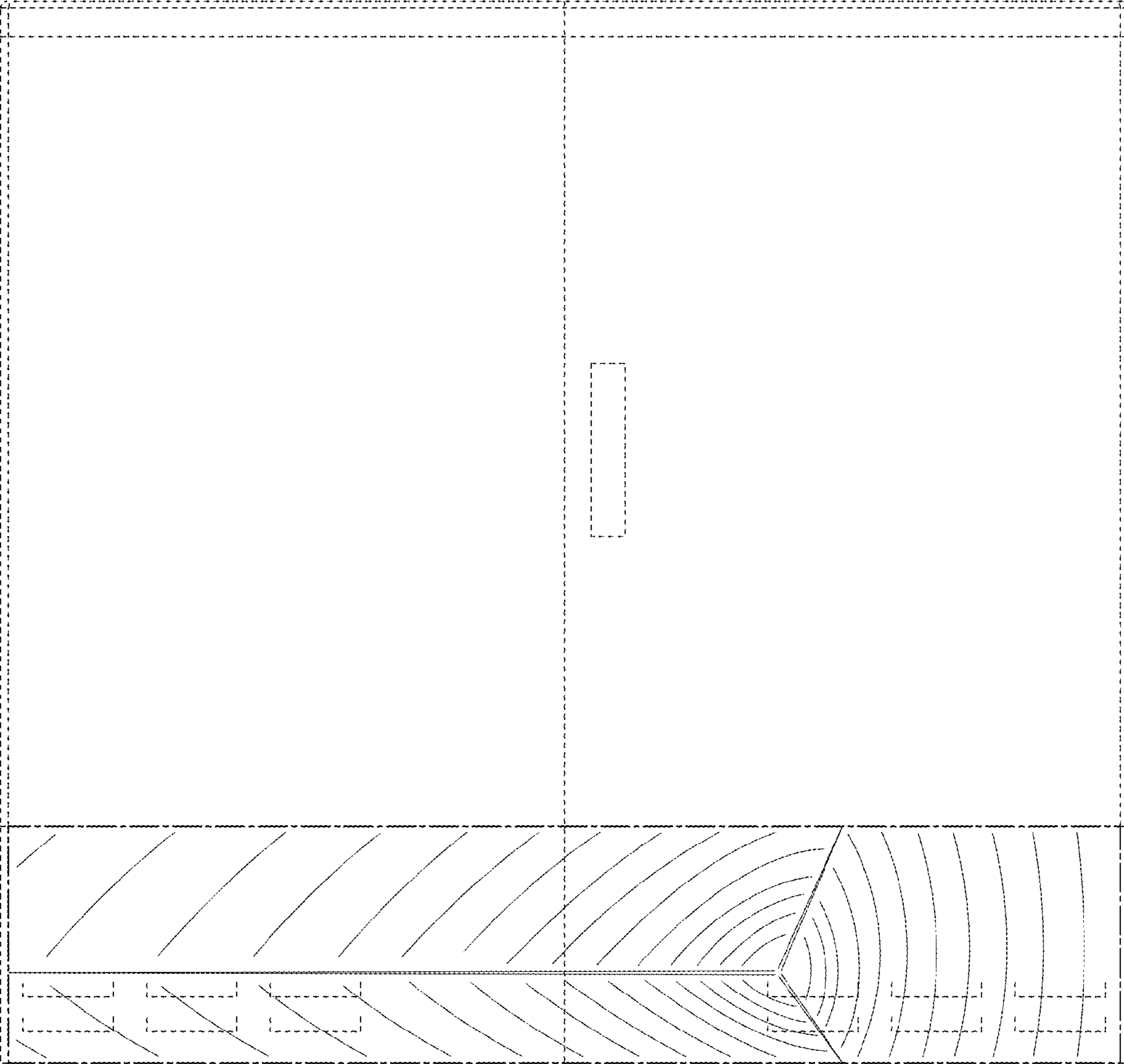

FIG. 23



FIG. 24

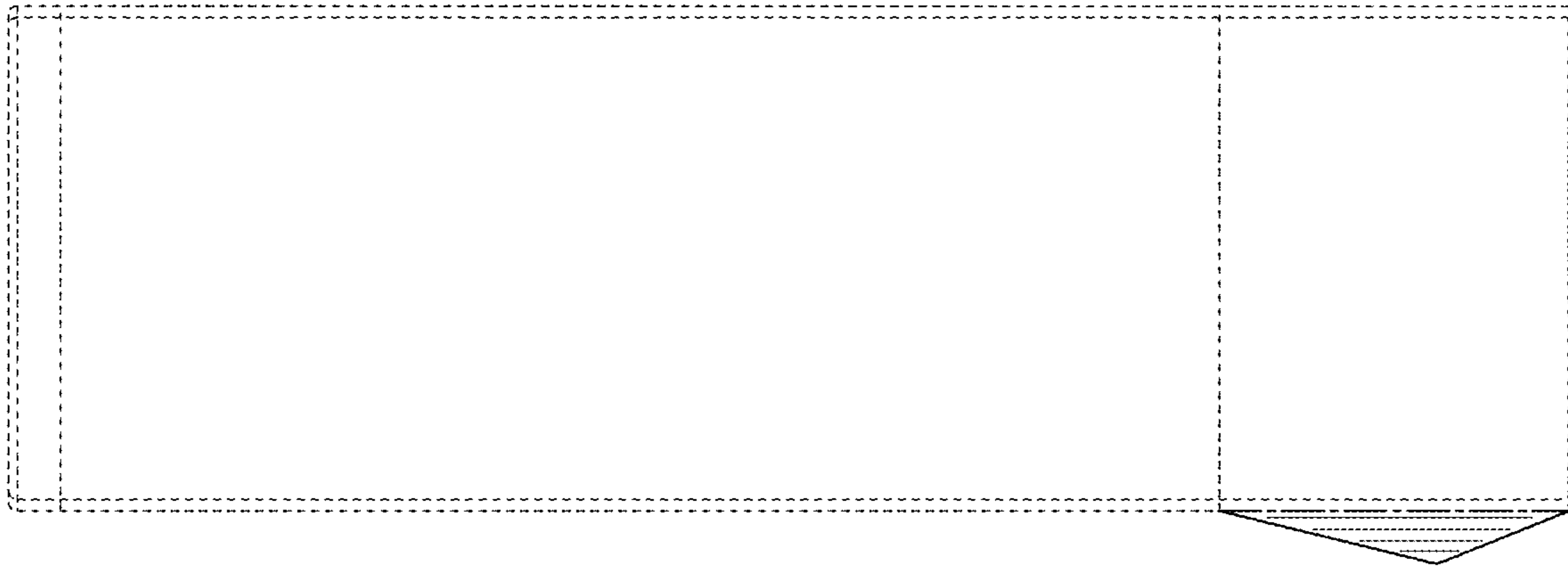

FIG. 26



FIG. 25

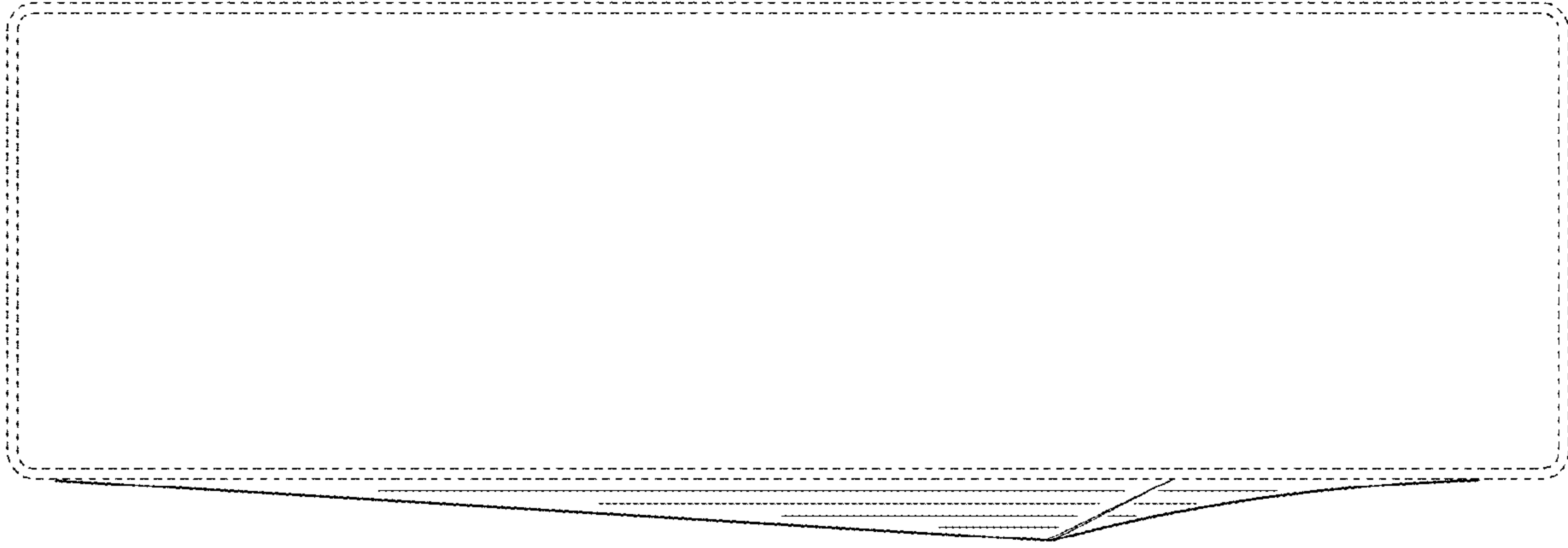

FIG. 27

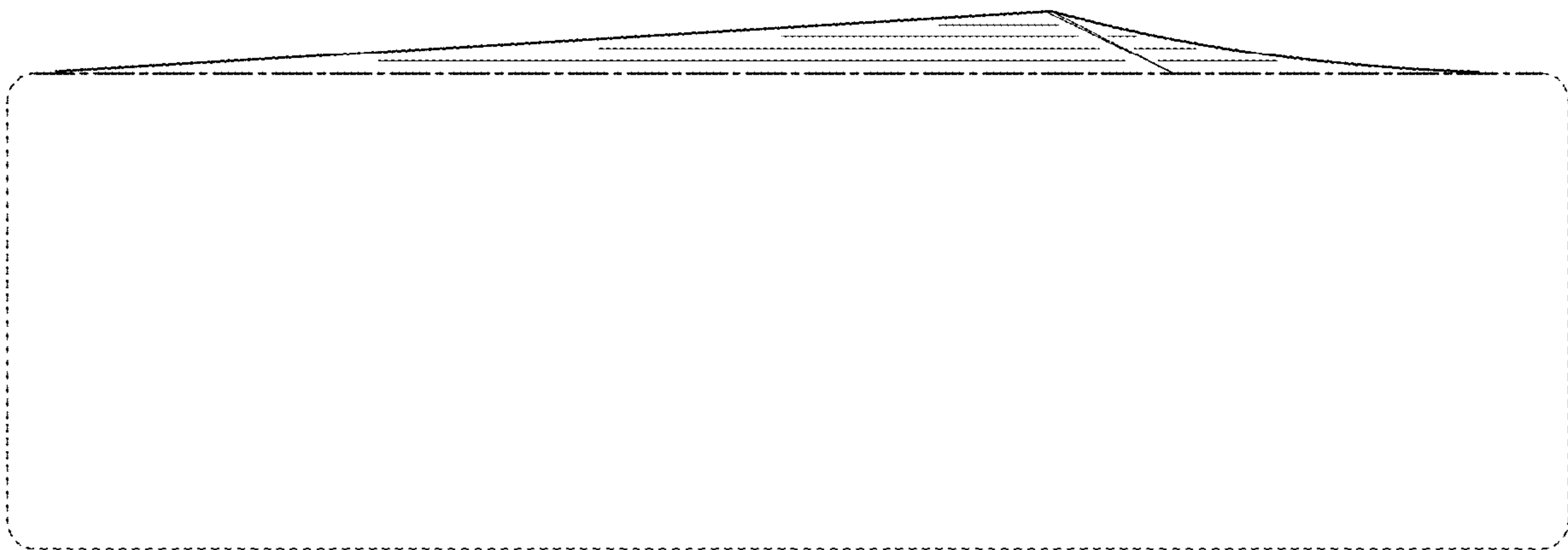

FIG. 28