

US00D960096S

(12) **United States Design Patent**  
**Li**

(10) **Patent No.:** **US D960,096 S**

(45) **Date of Patent:** **\*\* Aug. 9, 2022**

- (54) **PORTABLE POWER STATION**
- (71) Applicant: **TENERGY CORPORATION**,  
Fremont, CA (US)
- (72) Inventor: **Xiangbing Li**, Palo Alto, CA (US)
- (73) Assignee: **Tenergy Corporation**, Fremont, CA  
(US)
- (\*\*) Term: **15 Years**
- (21) Appl. No.: **29/733,680**
- (22) Filed: **May 5, 2020**
- (51) **LOC (13) Cl.** ..... **13-02**
- (52) **U.S. Cl.**  
USPC ..... **D13/110**
- (58) **Field of Classification Search**  
USPC ..... D13/103, 107–108, 110, 118–119, 184,  
D13/199, 106  
CPC ..... H02J 7/0013; H02J 7/0014; H02J 7/0019;  
H05K 5/0086; H01M 10/4257; H01M  
10/441; H01M 10/46  
See application file for complete search history.

- D911,935 S \* 3/2021 Alexander ..... D13/107
- D911,953 S \* 3/2021 Yin ..... D13/103
- D930,585 S \* 9/2021 Yu ..... D13/110
- D931,800 S \* 9/2021 Fang ..... D13/103
- D936,007 S \* 11/2021 Huang ..... D13/110
- D938,355 S \* 12/2021 Xiong ..... D13/110
- D942,932 S \* 2/2022 Yin ..... D13/107

\* cited by examiner

*Primary Examiner* — Rosemary K Tarcza

(74) *Attorney, Agent, or Firm* — Sheppard Mullin Richter  
& Hampton LLP

(57) **CLAIM**

The ornamental design for a portable power station, as shown and described.

**DESCRIPTION**

FIG. 1 is a perspective view showing an embodiment of a portable power station showing our new design;  
 FIG. 2 is a front view thereof;  
 FIG. 3 is a rear view thereof;  
 FIG. 4 is a left-side view thereof;  
 FIG. 5 is a right-side view thereof;  
 FIG. 6 is a top view thereof; and,  
 FIG. 7 is a bottom view thereof.  
 The broken lines in FIGS. 1 through 7 depict parts of the portable power station that form no part of the claimed design.

(56) **References Cited**

U.S. PATENT DOCUMENTS

- D815,039 S \* 4/2018 Wen ..... D13/110
- D874,398 S \* 2/2020 Sun ..... D13/107
- D883,206 S \* 5/2020 Bai ..... D13/110
- D911,273 S \* 2/2021 Sun ..... D13/103

**1 Claim, 7 Drawing Sheets**

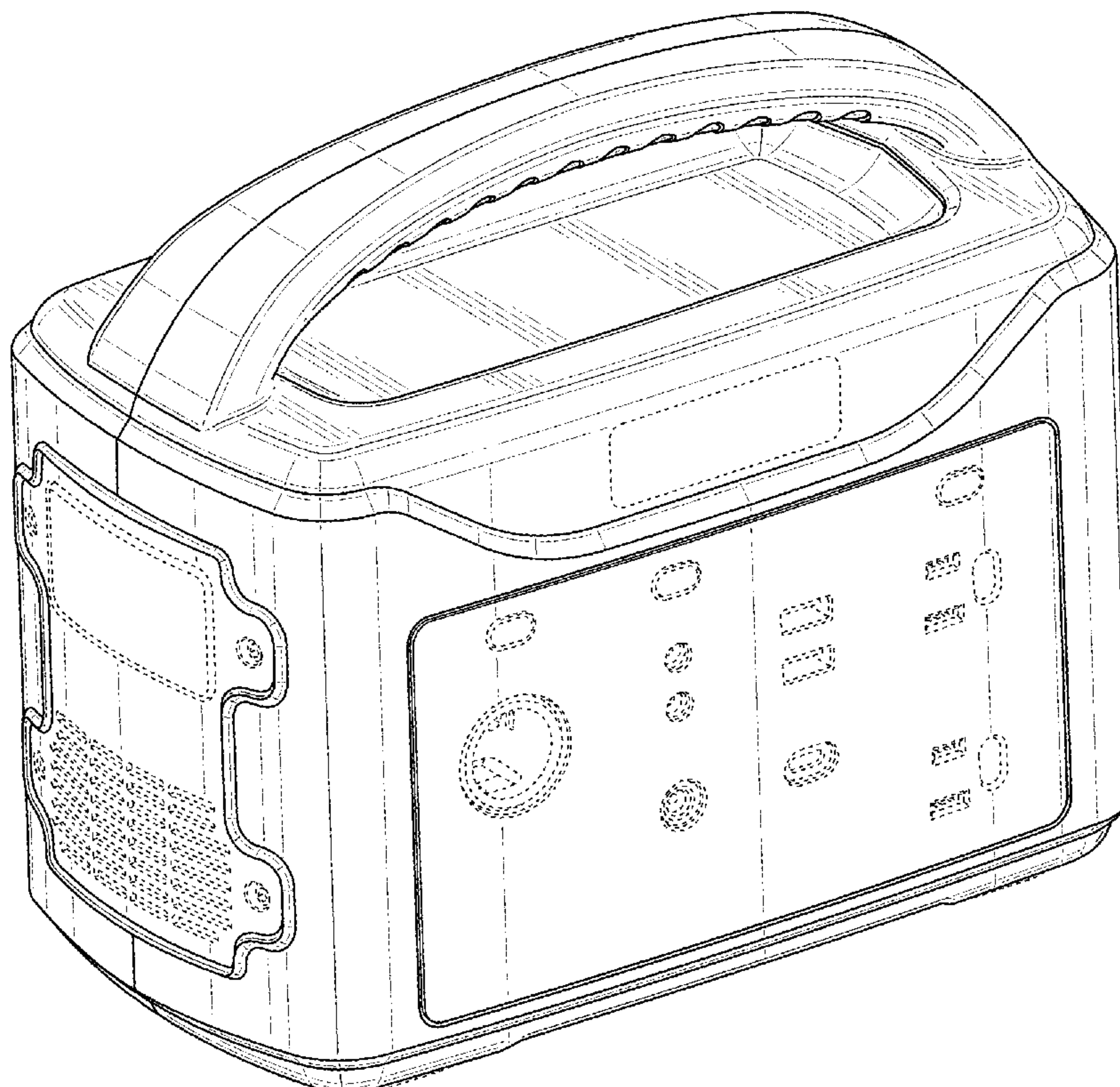

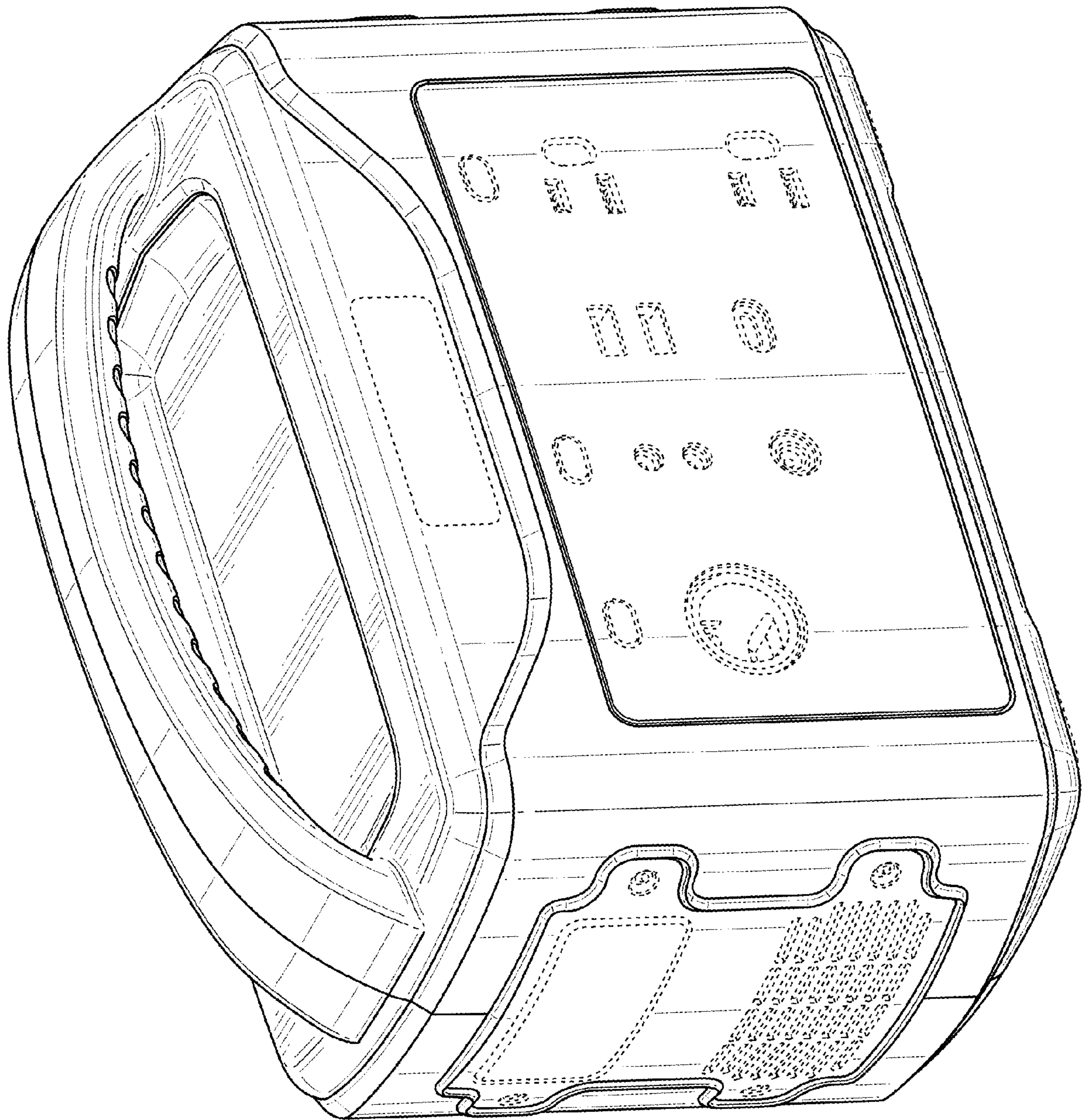

**FIG. 1**



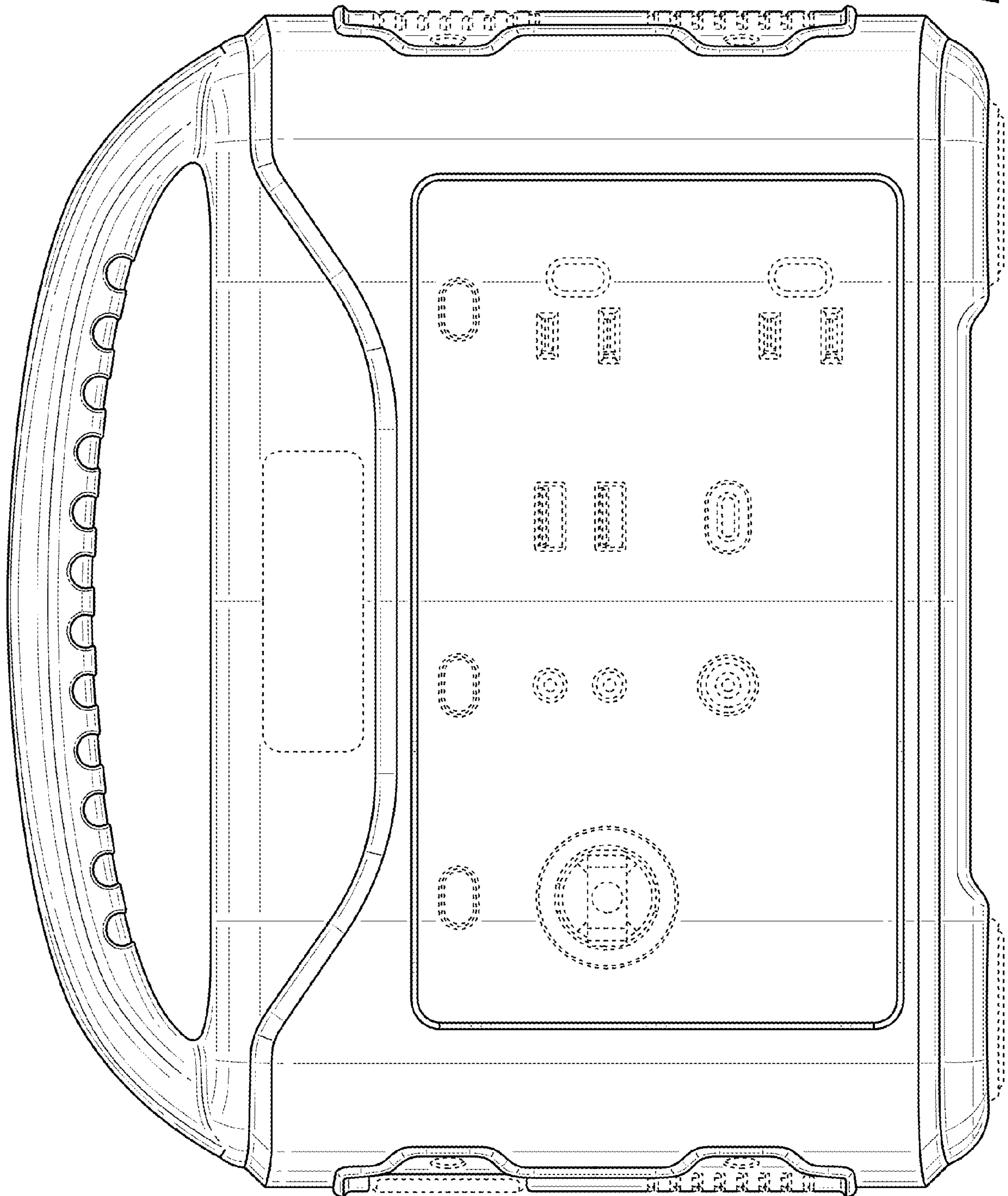

FIG. 2

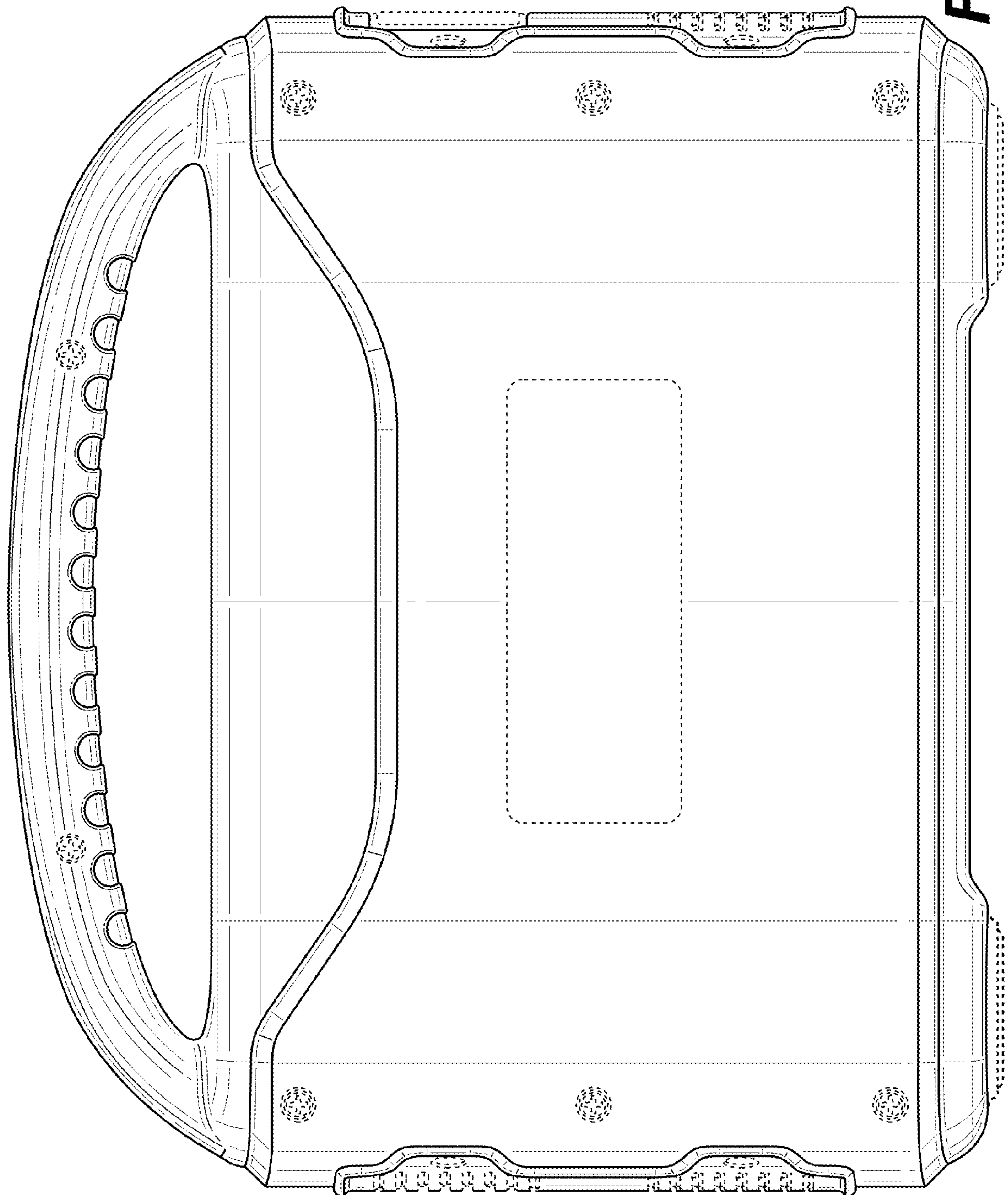
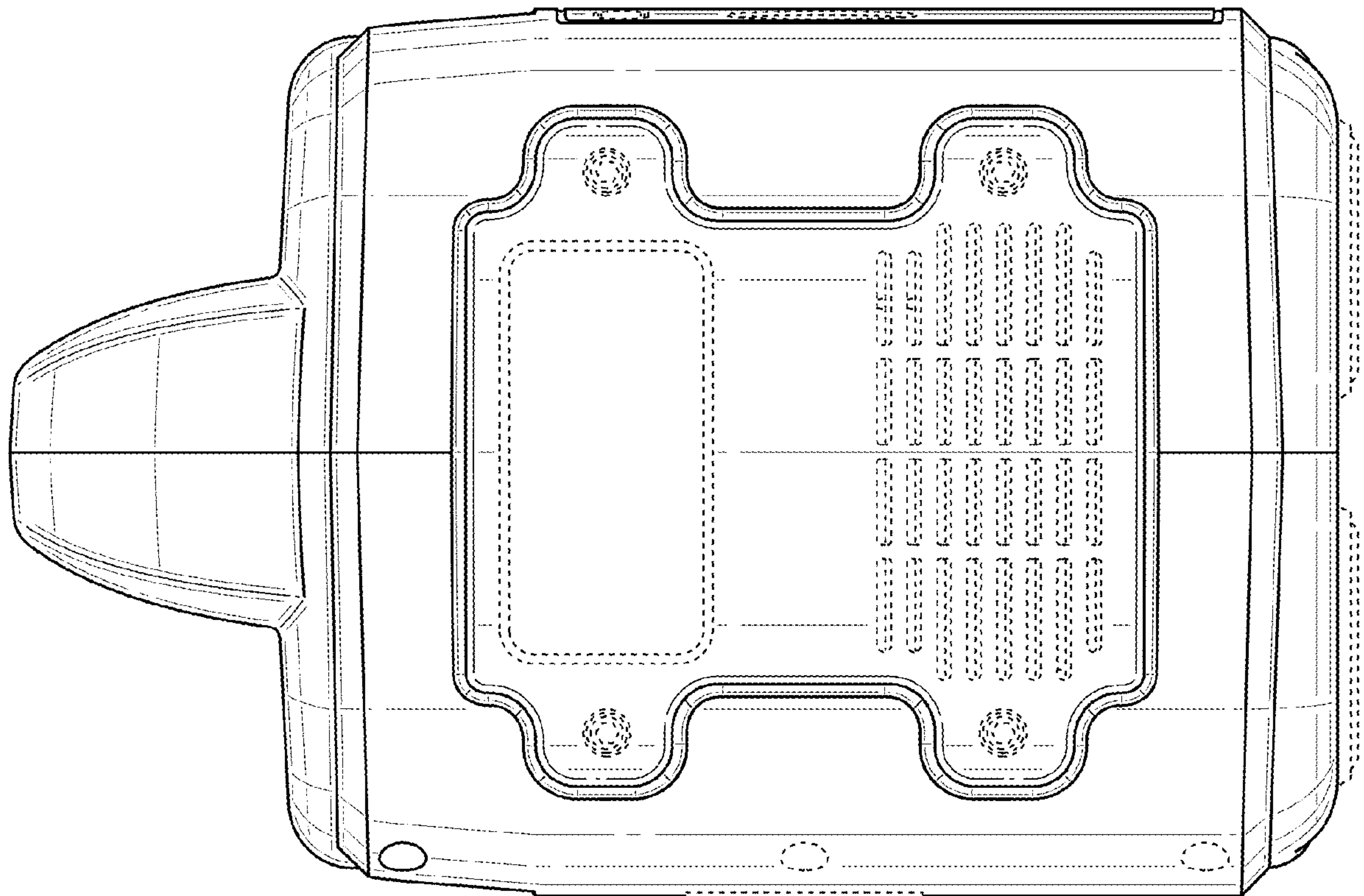
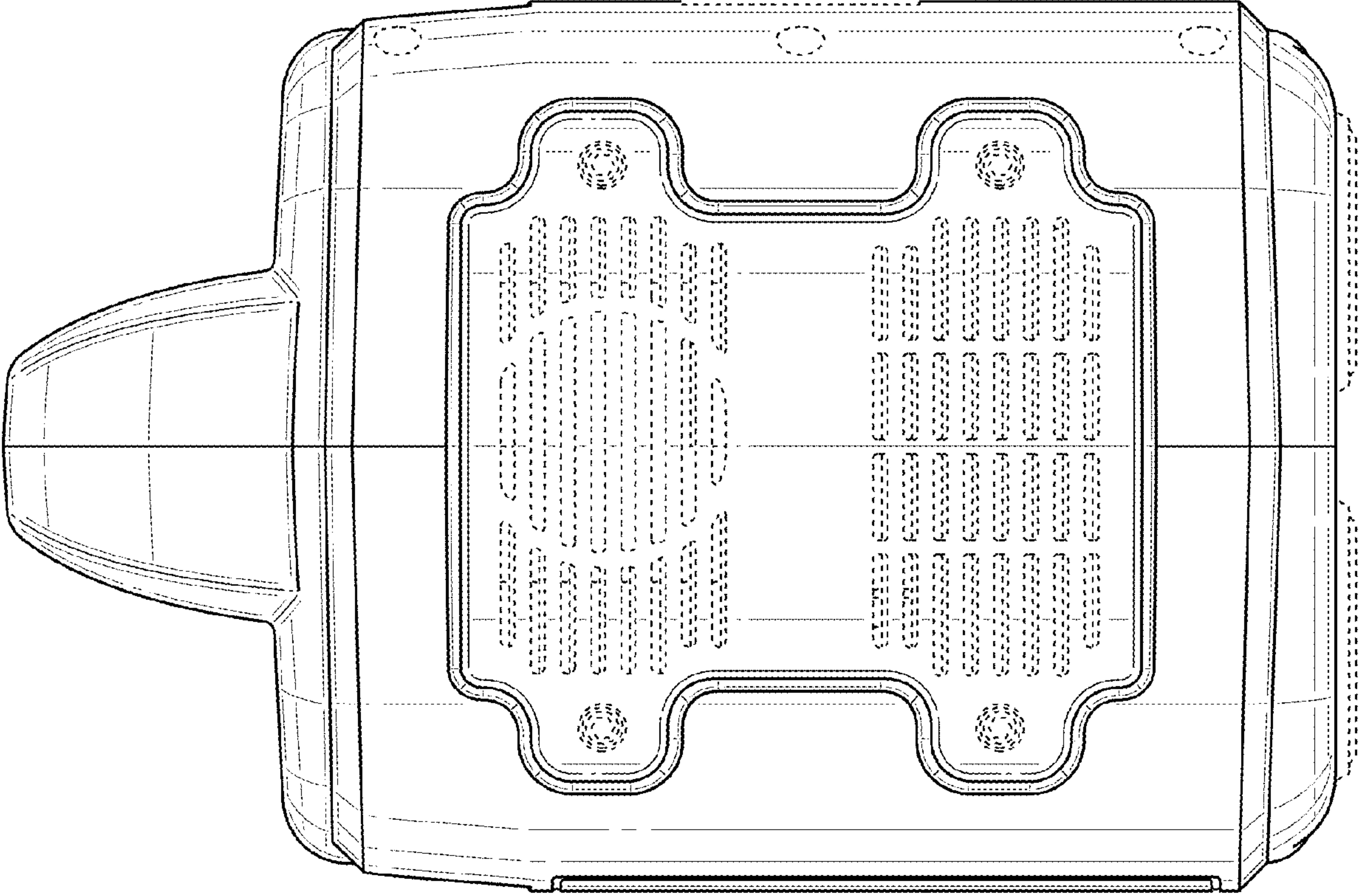

FIG. 3

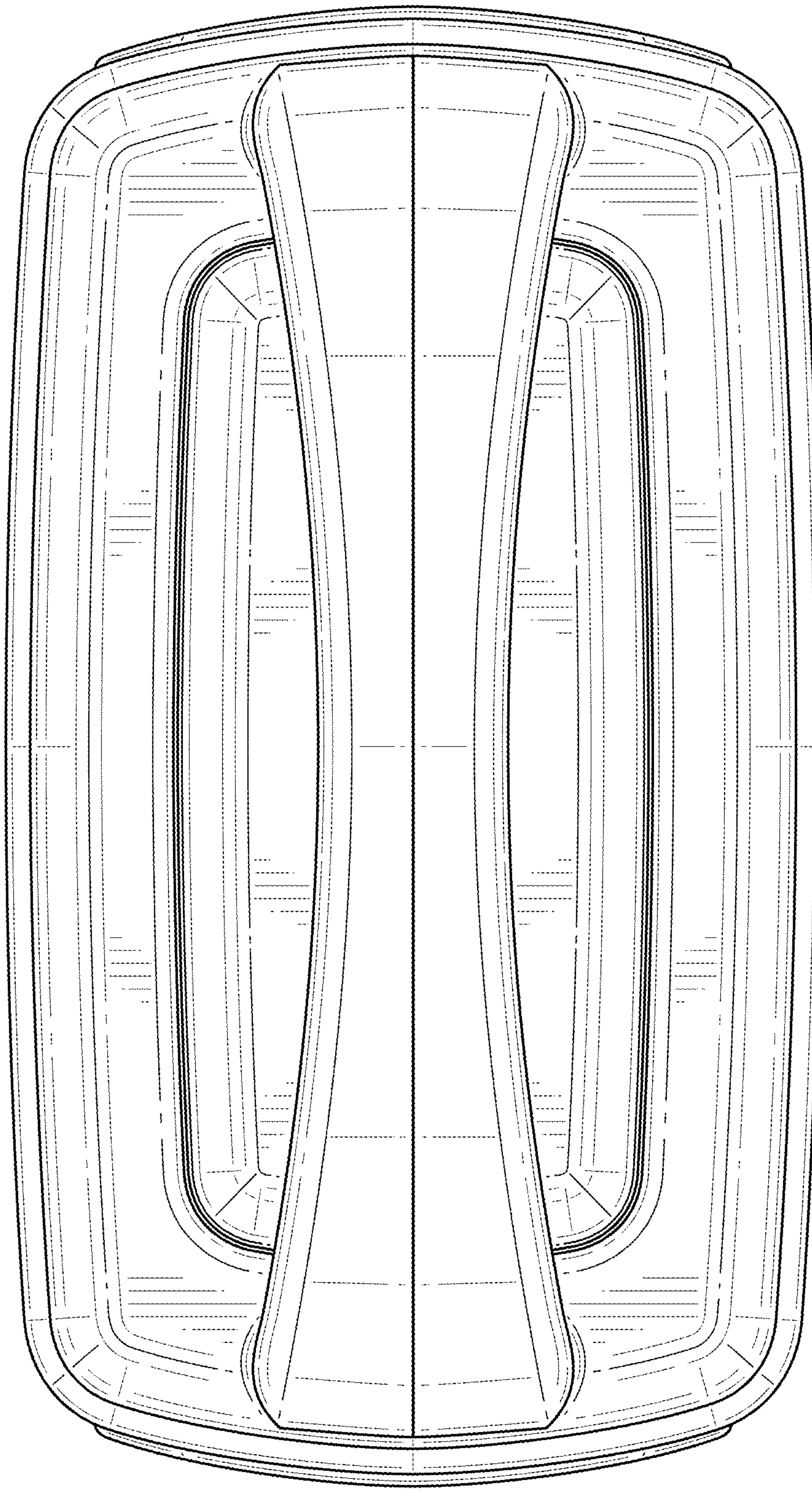

**FIG. 4**

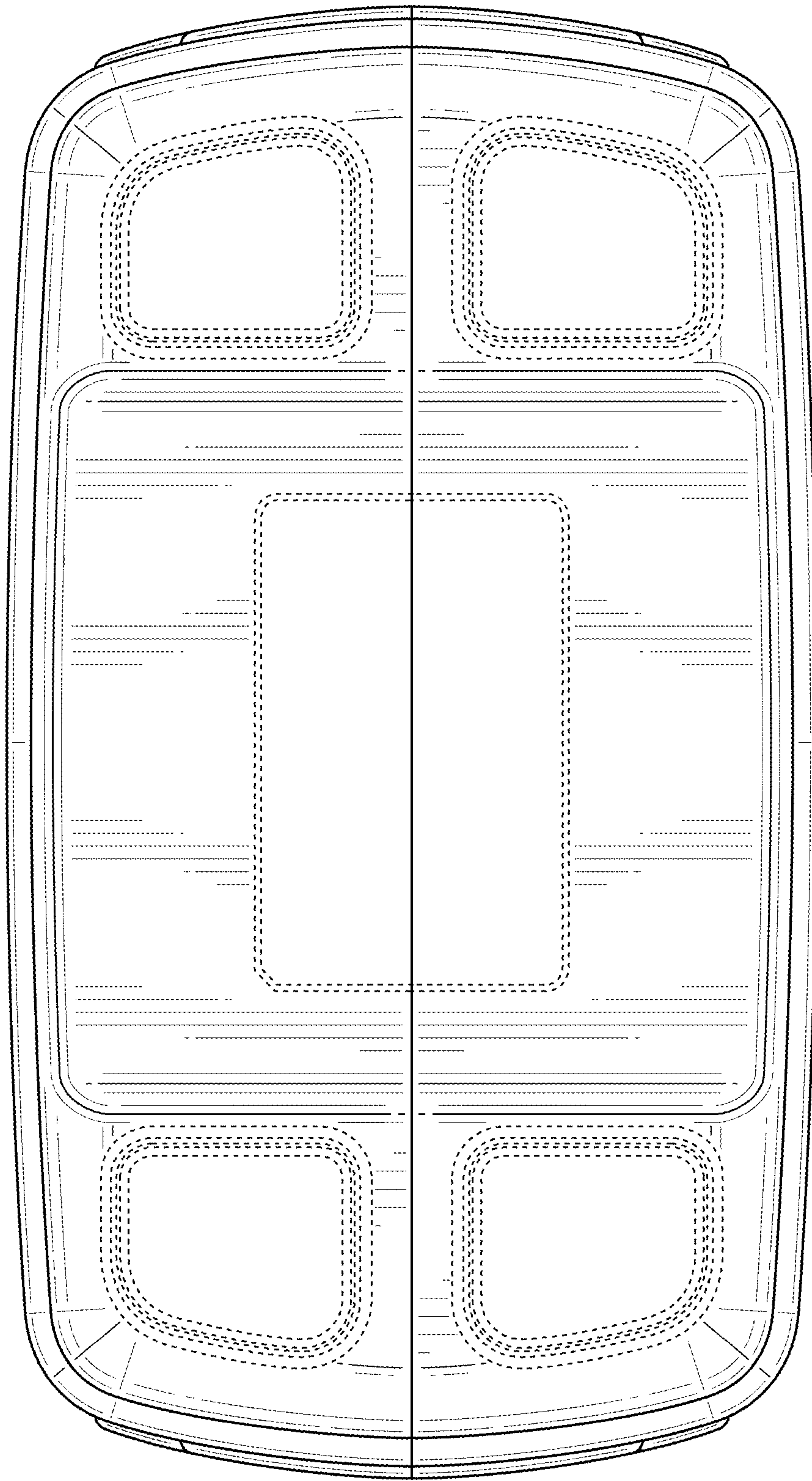

**FIG. 5**





**FIG. 6**



**FIG. 7**