



US00D959955S

(12) **United States Design Patent** (10) **Patent No.:** **US D959,955 S**
Tuetken et al. (45) **Date of Patent:** **** Aug. 9, 2022**

(54) **LOCK LEVER**

(71) Applicant: **Pella Corporation**, Pella, IA (US)

(72) Inventors: **Jennifer A. Tuetken**, Des Moines, IA (US); **Mark A. Hetrick**, Akeny, IA (US); **William R. Parcels**, Des Moines, IA (US)

(73) Assignee: **Pella Corporation**, Pella, IA (US)

(**) Term: **15 Years**

(21) Appl. No.: **29/765,286**

(22) Filed: **Jan. 7, 2021**

(51) **LOC (13) Cl.** **08-07**

(52) **U.S. Cl.**
USPC **D8/338**; D8/343

(58) **Field of Classification Search**
USPC D8/300–302, 307–309, 310, 311, 331, D8/336, 337, 338, 343, 400
CPC E05Y 2900/148; E05Y 2900/55; E05F 2700/04; E05F 11/00; E05C 17/443; E05C 17/345; E05C 3/041
See application file for complete search history.

(56) **References Cited**

U.S. PATENT DOCUMENTS

D304,994 S *	12/1989	Harold	D8/308
D334,132 S *	3/1993	Wobschall	D8/337
5,489,131 A *	2/1996	Blom	E05C 3/047 292/DIG. 20
D388,689 S *	1/1998	Bauman	D8/337
D390,445 S *	2/1998	Johnson	D8/337
5,741,031 A *	4/1998	Bauman	E05B 63/0052 292/DIG. 7
5,839,767 A *	11/1998	Piltingsrud	E05C 9/02 292/336.3
6,142,541 A *	11/2000	Rotondi	E05C 3/046 292/DIG. 20

(Continued)

Primary Examiner — Lauren R Calve

(74) *Attorney, Agent, or Firm* — Faegre Drinker Biddle & Reath LLP

(57) **CLAIM**

The ornamental design for a lock lever, as shown and described.

DESCRIPTION

FIG. 1 is a front and top perspective view of a first embodiment of a lock lever, embodying our new design; FIG. 2 is a front and bottom perspective view of the first embodiment; FIG. 3 is a left side elevational view of the first embodiment; FIG. 4 is a right side elevational view of the first embodiment; FIG. 5 is a back elevational view of the first embodiment; FIG. 6 is a front elevational view of the first embodiment; FIG. 7 is a top plan view of the first embodiment; FIG. 8 is a bottom plan view of the first embodiment; FIG. 9 is a front and top perspective view of a second embodiment of a lock lever, embodying our new design; FIG. 10 is a front and bottom perspective view of the second embodiment; FIG. 11 is a left side elevational view of the second embodiment; FIG. 12 is a right side elevational view of the second embodiment; FIG. 13 is a back elevational view of the second embodiment; FIG. 14 is a front elevational view of the second embodiment; FIG. 15 is a top plan view of the second embodiment; and, FIG. 16 is a bottom plan view of the second embodiment. The broken lines shown represent portions of the lock lever that form no part of the claimed design.

1 Claim, 12 Drawing Sheets

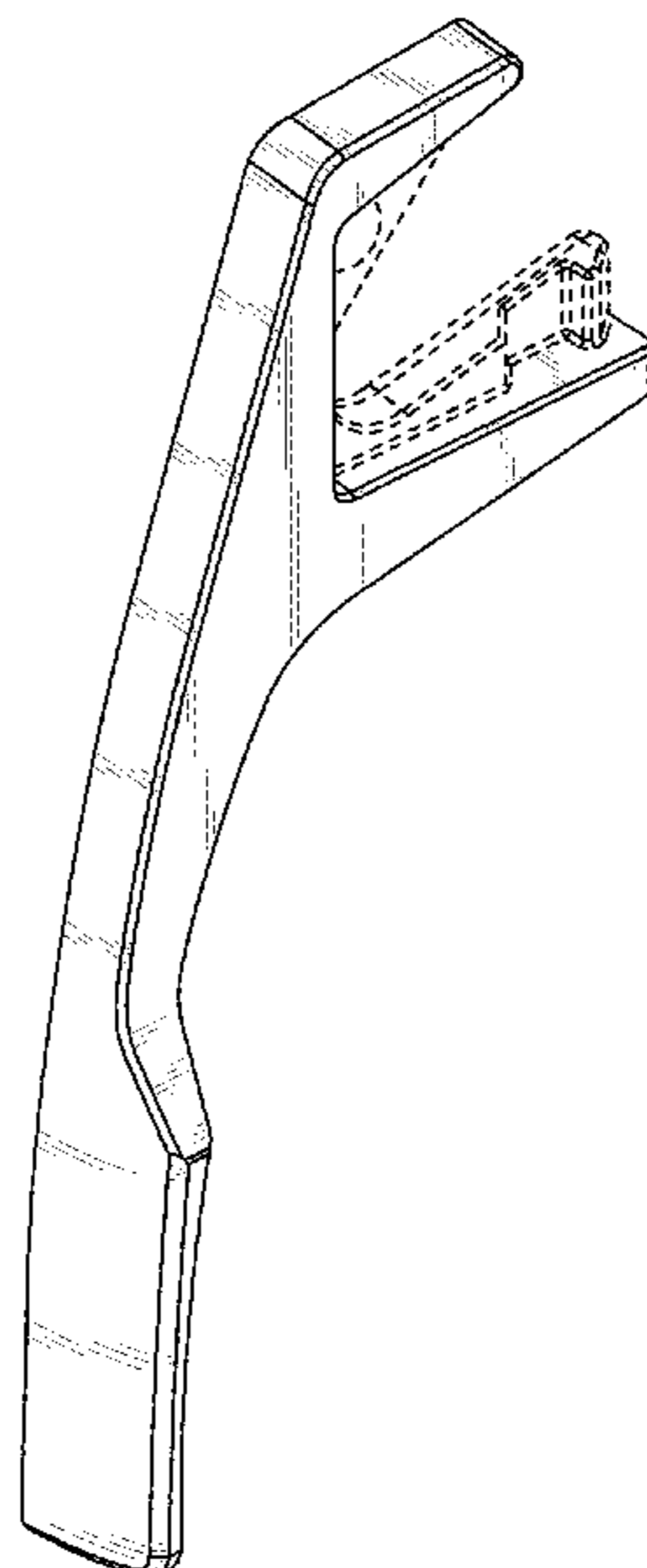

(56)

References Cited

U.S. PATENT DOCUMENTS

D435,429 S * 12/2000 Barnett D8/338
6,367,853 B1 * 4/2002 Briggs E05C 9/025
74/544
D496,246 S * 9/2004 Nguyen D8/338
D554,971 S * 11/2007 Flory D8/308
D572,112 S * 7/2008 Schlumbom D8/337
D583,211 S * 12/2008 Grohmann D8/300
D762,445 S * 8/2016 Thomson D8/343
2004/0262929 A1 * 12/2004 Trickel E05B 65/0841
292/241
2008/0012358 A1 * 1/2008 Liang E05C 3/043
292/241

* cited by examiner

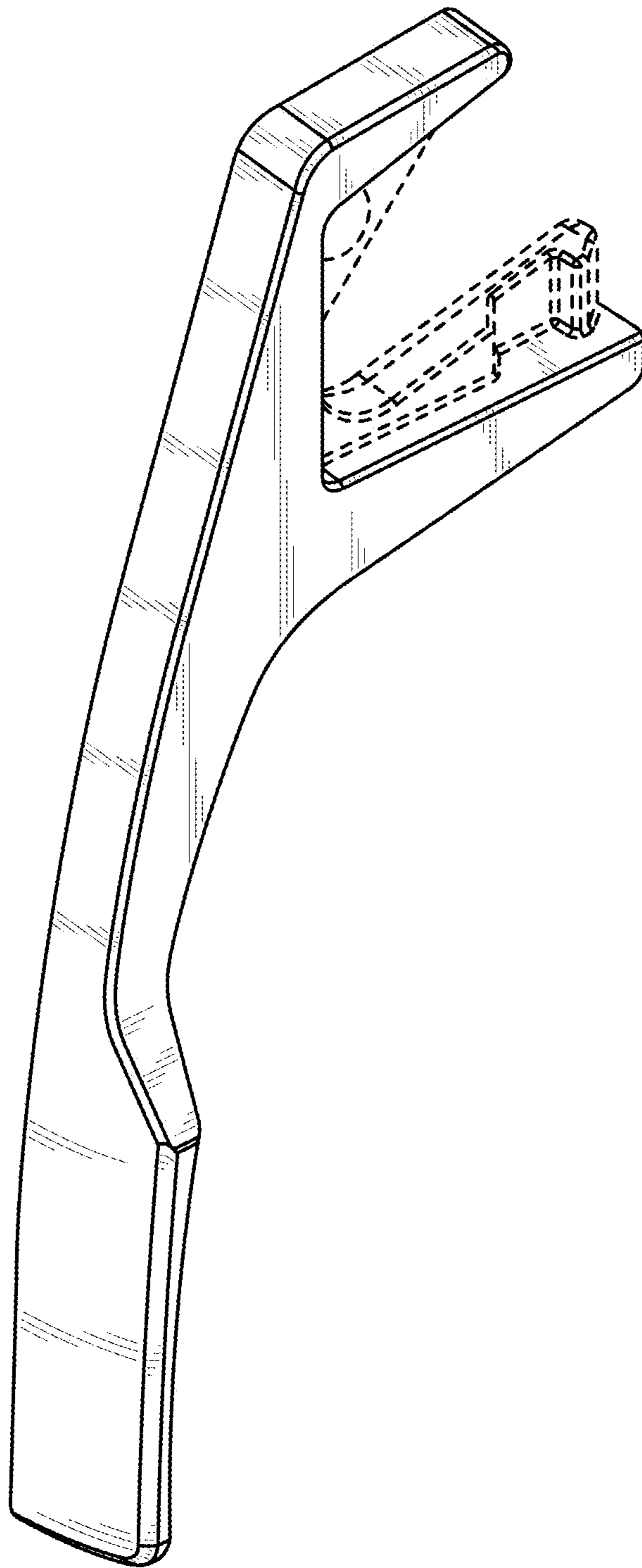

FIG. 1

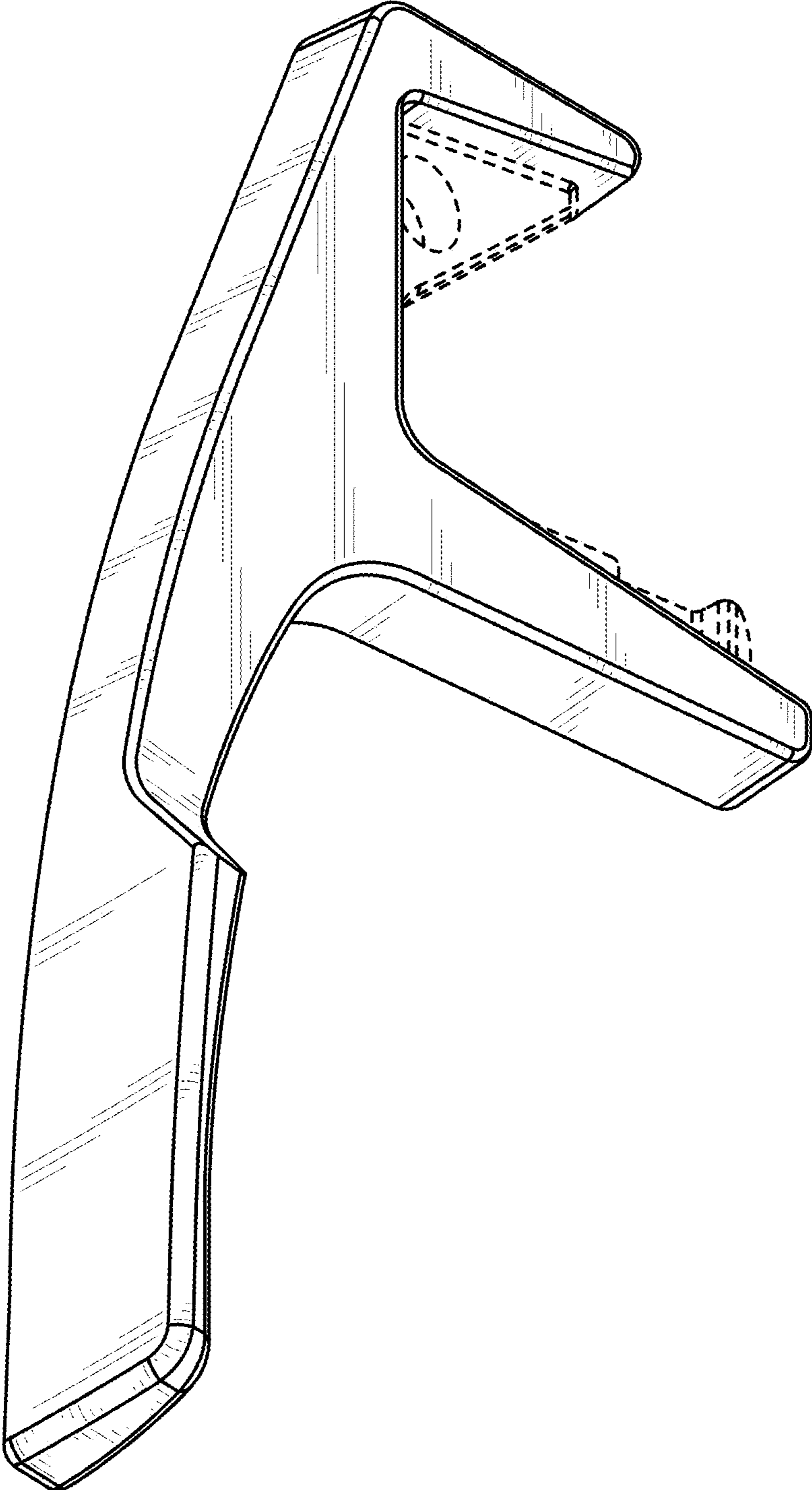

FIG. 2

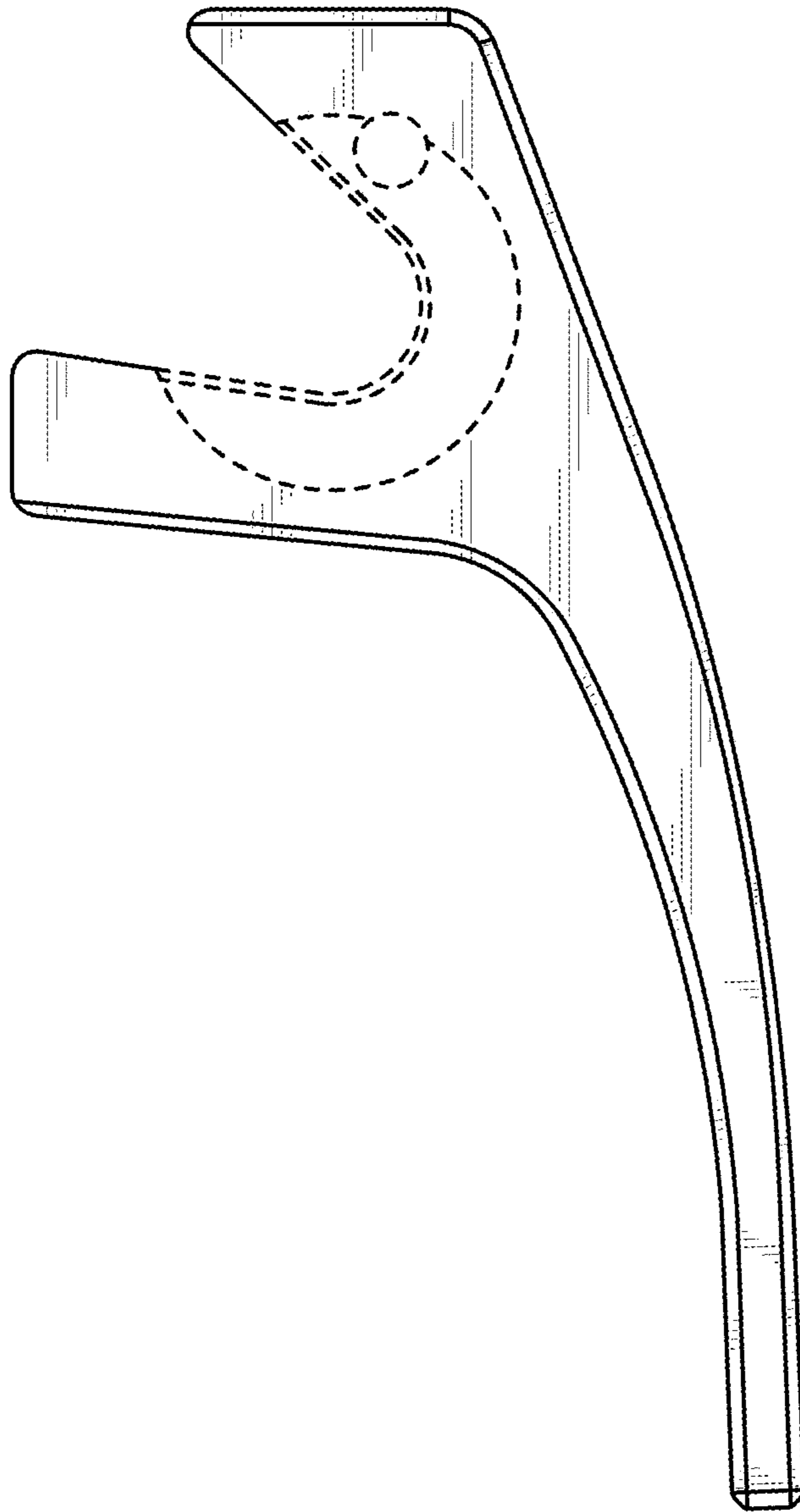

FIG. 3

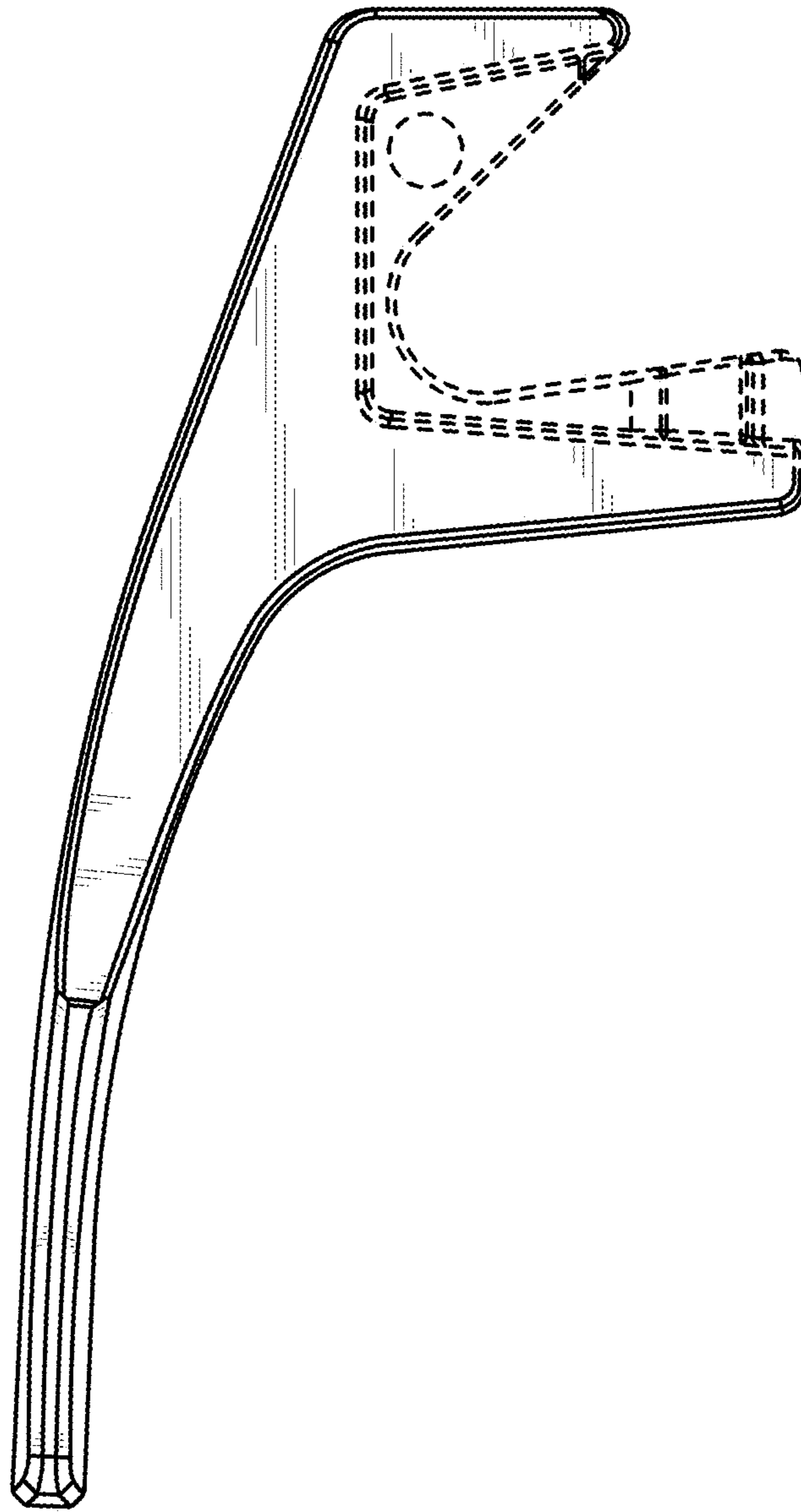

FIG. 4

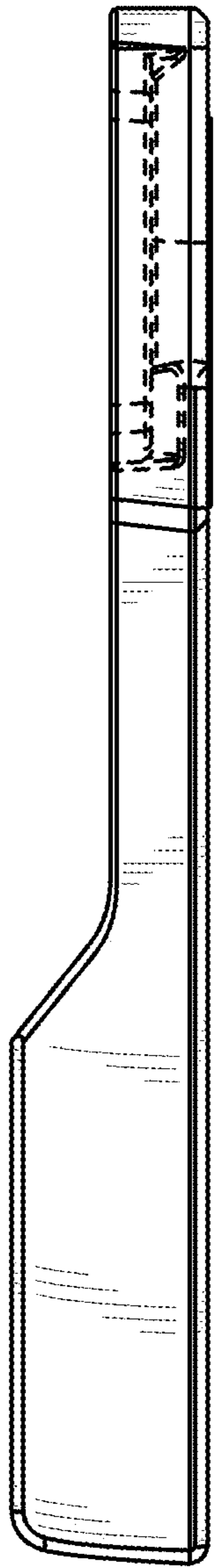

FIG. 5

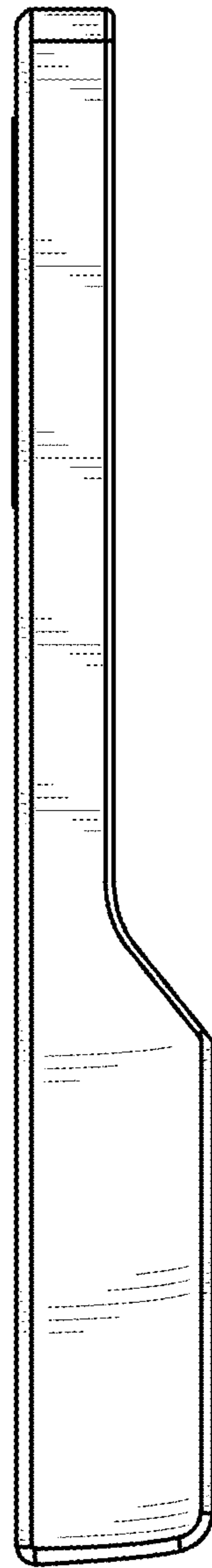

FIG. 6

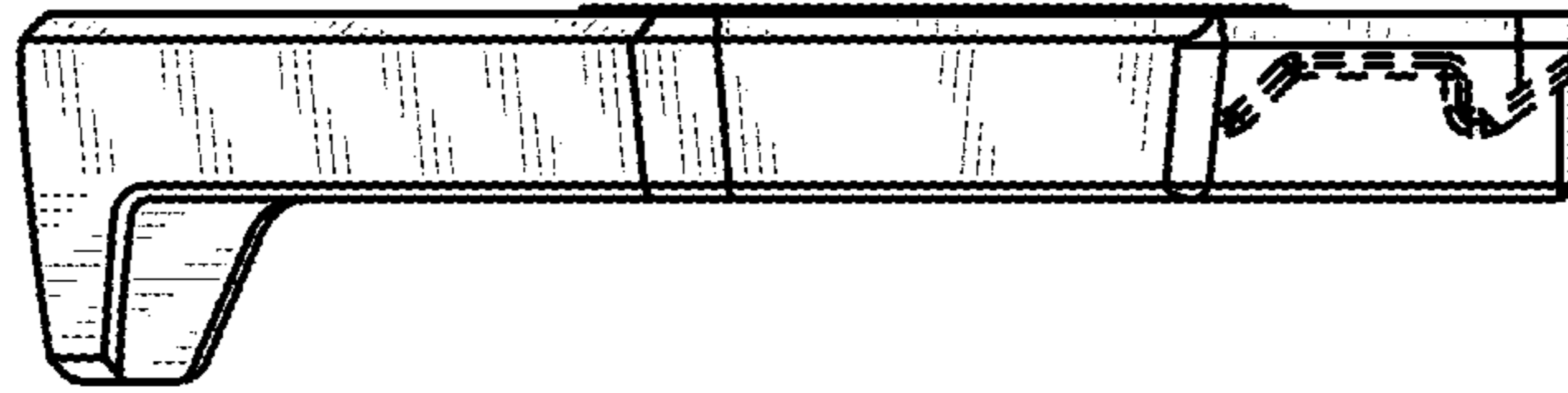

FIG. 7

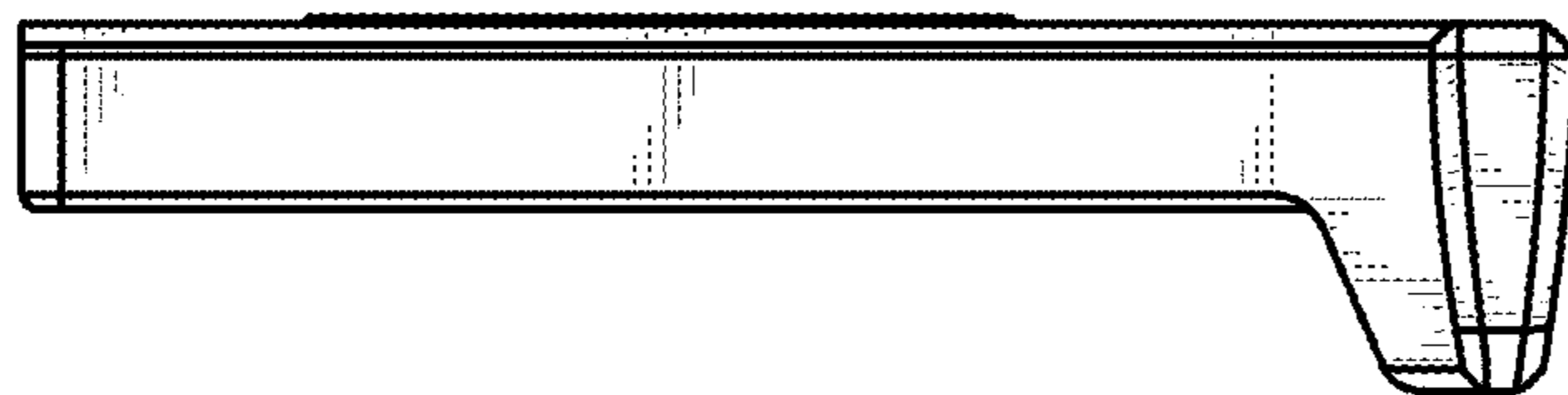

FIG. 8

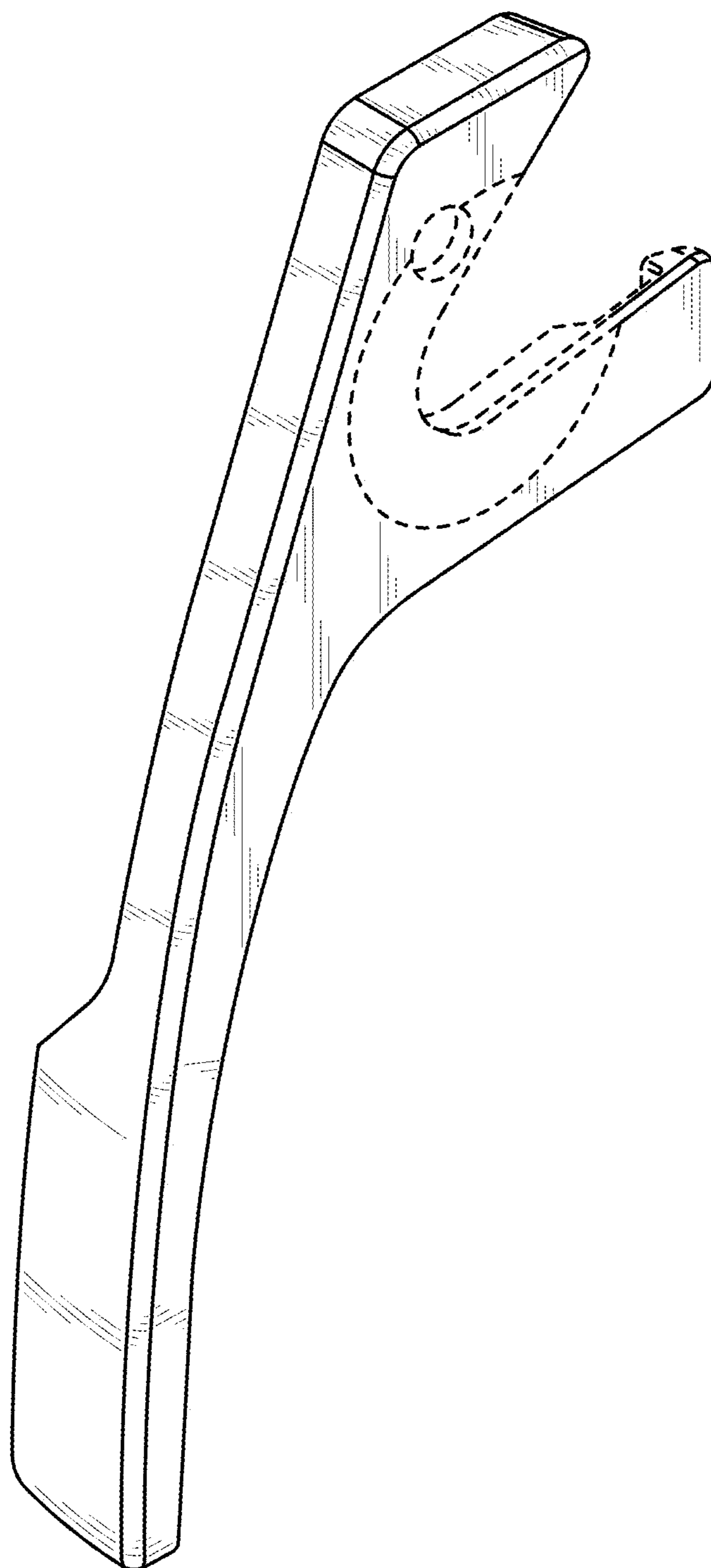

FIG. 9

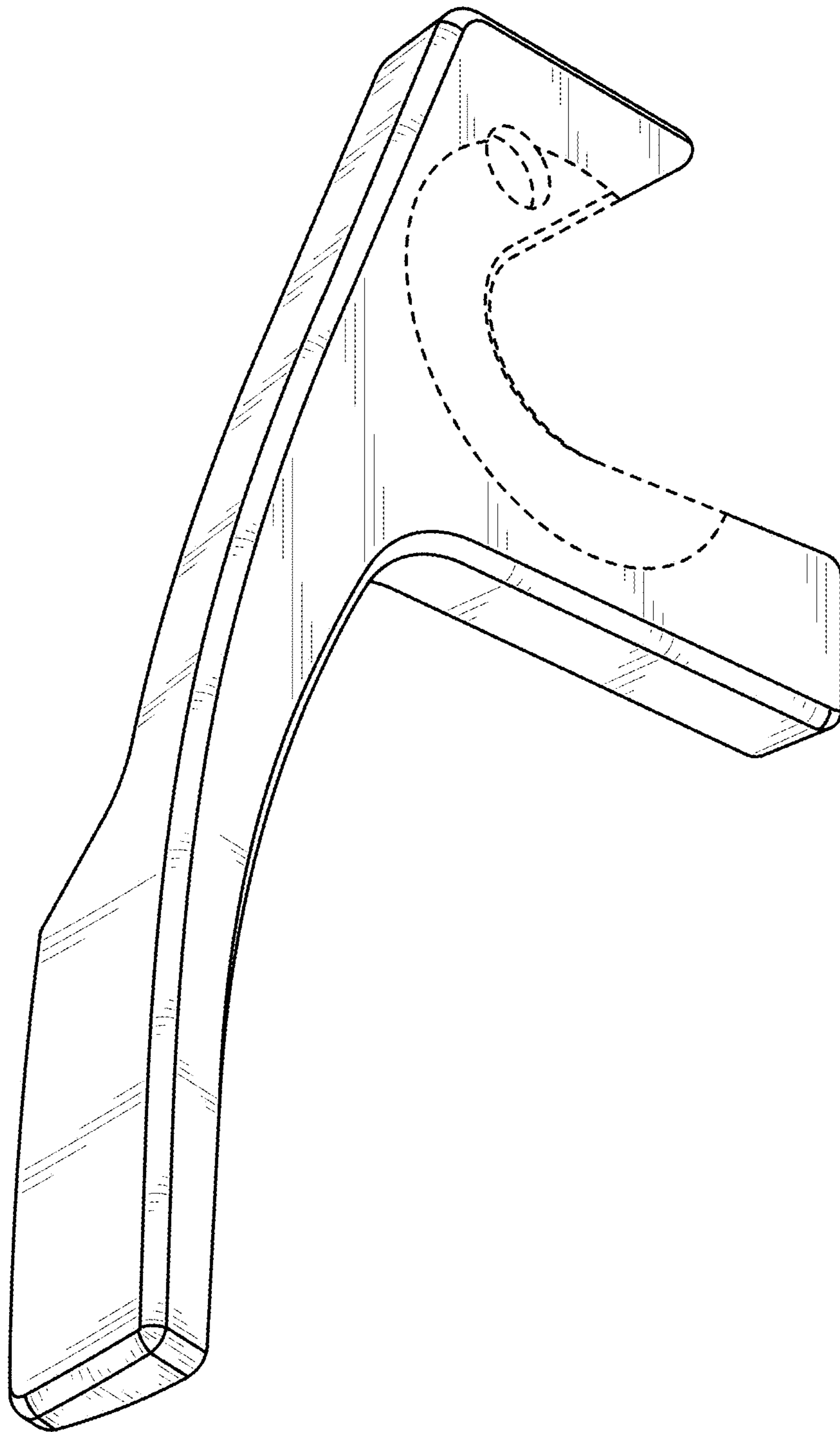

FIG. 10

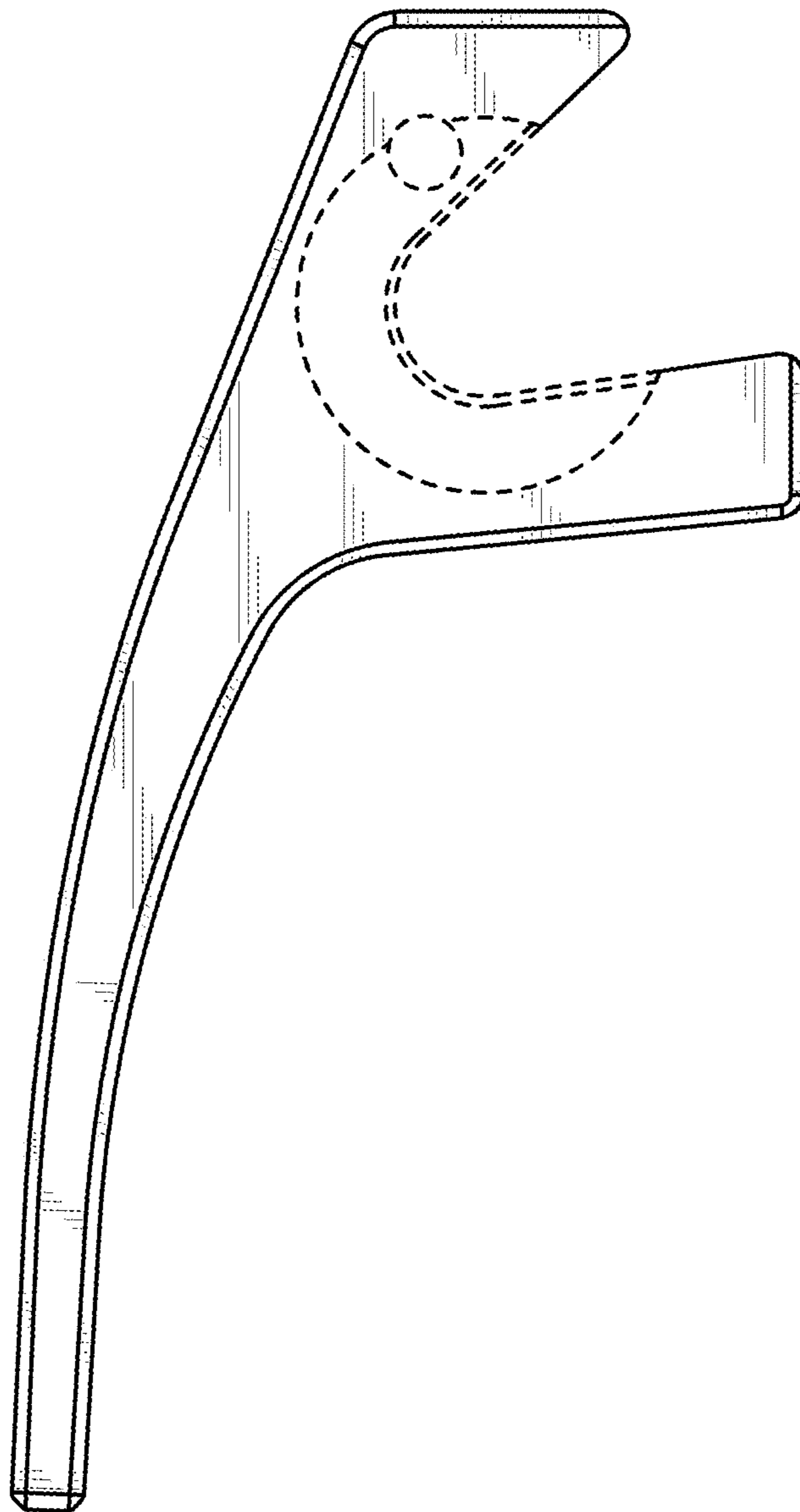

FIG. 11

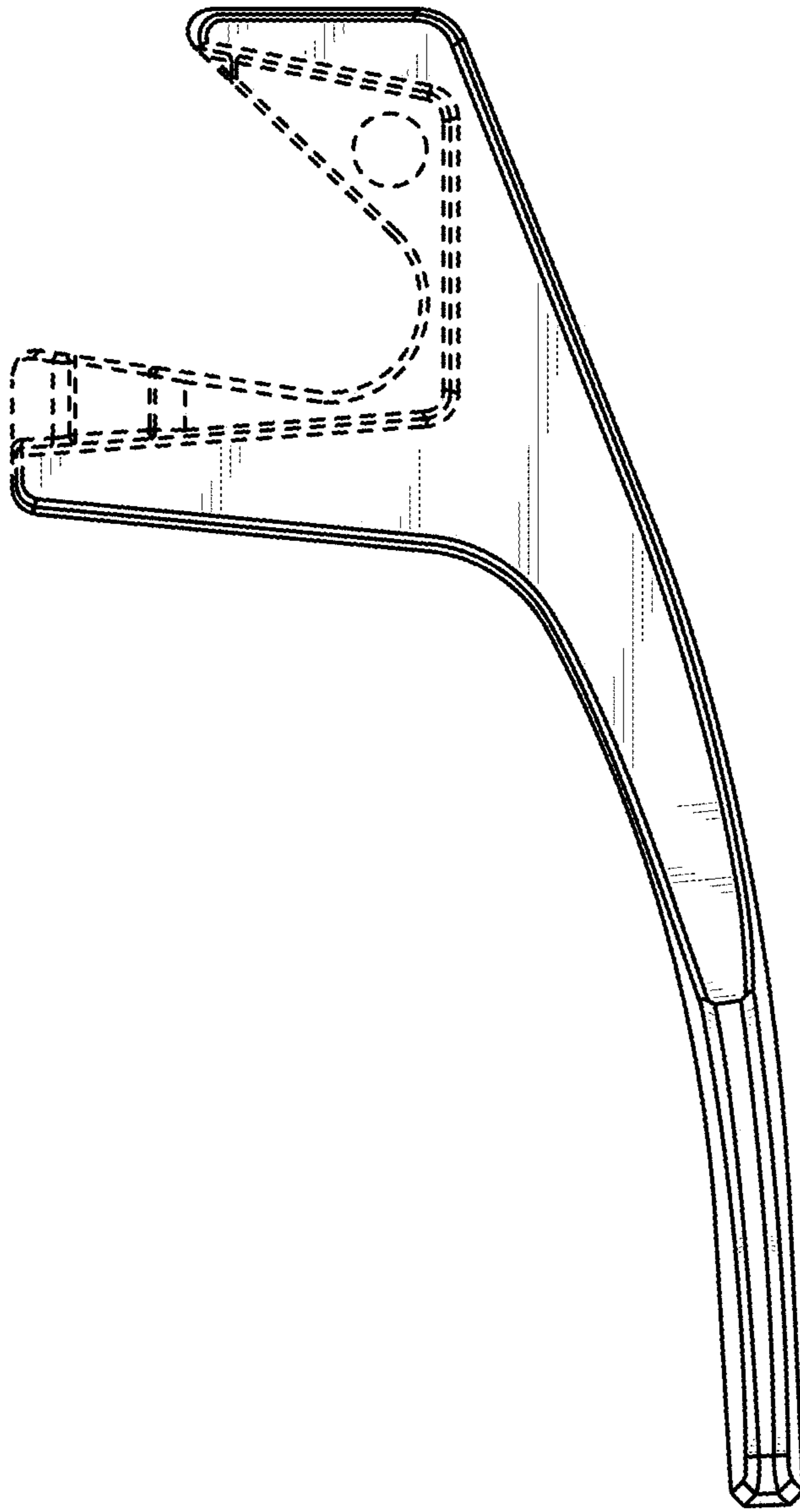

FIG. 12

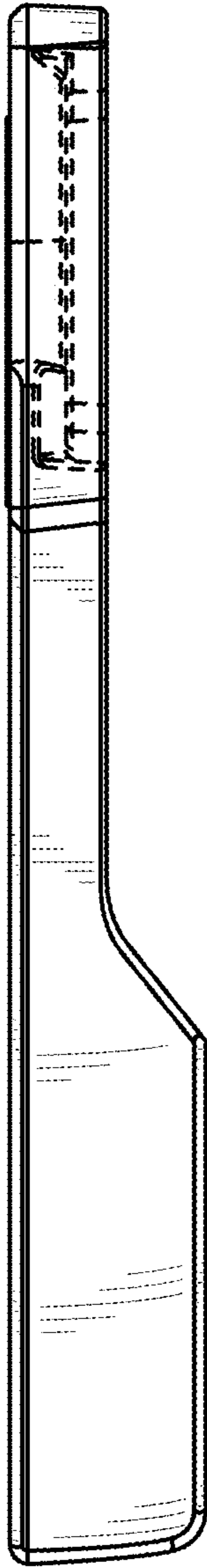

FIG. 13

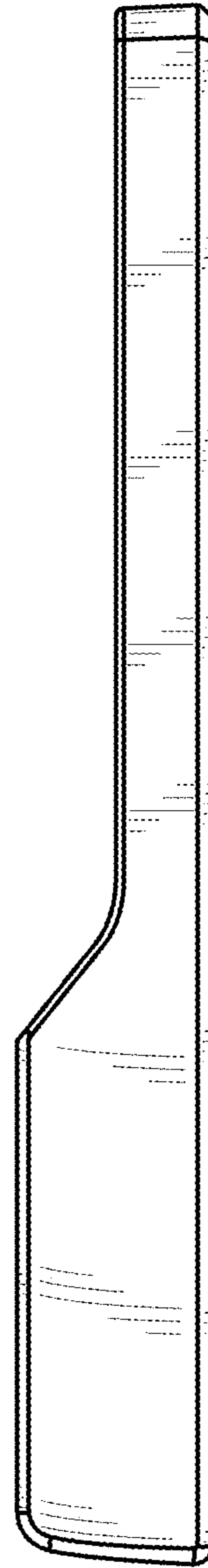

FIG. 14

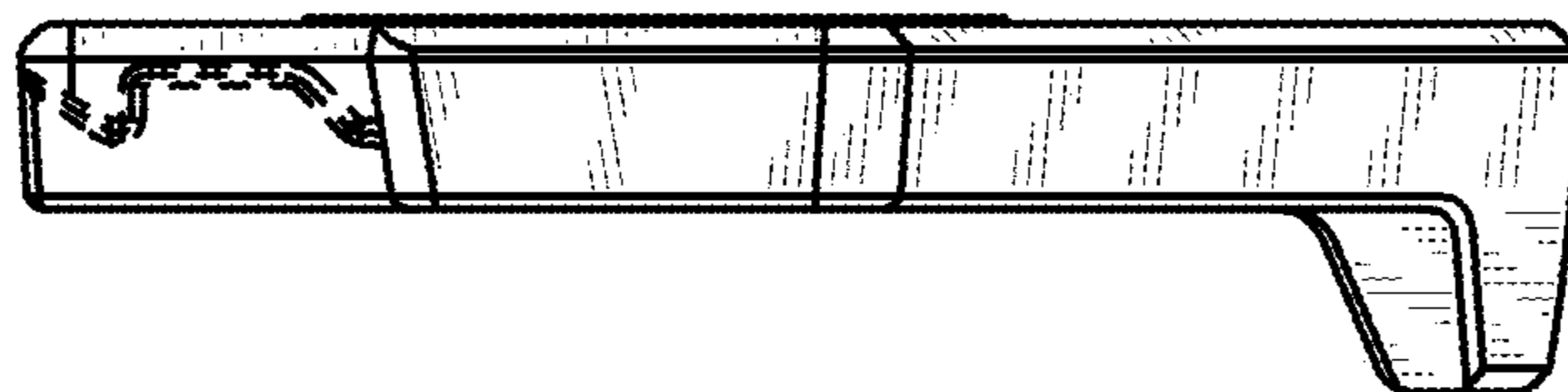

FIG. 15

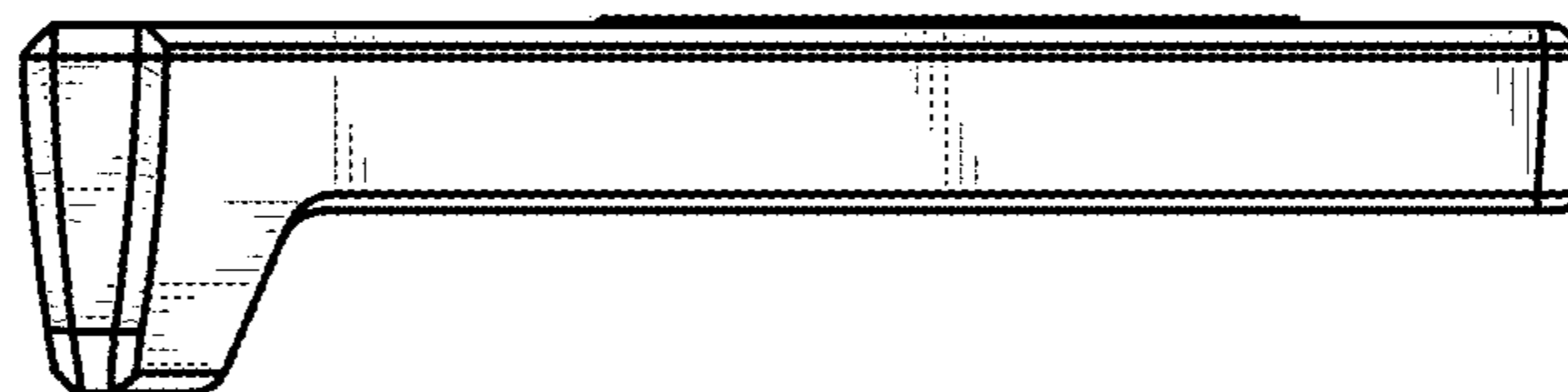

FIG. 16