



US00D959950S

(12) **United States Design Patent** (10) **Patent No.:** **US D959,950 S**
Lin (45) **Date of Patent:** **** Aug. 9, 2022**

(54) **MULTIFUNCTION TOOL**

OTHER PUBLICATIONS

(71) Applicant: **YANGDONG HAOXIANG
INDUSTRY AND TRADE CO., LTD.,
Yangjiang (CN)**

Amazon search results from search for axe multi tool. Jun. 13, 2022.*

* cited by examiner

(72) Inventor: **Miao Lin, Yangjiang (CN)**

Primary Examiner — Philip S Hyder

(73) Assignee: **YANGDONG HAOXIANG
INDUSTRY AND TRADE CO., LTD.,
Yangjiang (CN)**

(57) **CLAIM**

(**) Term: **15 Years**

The ornamental design for a multifunction tool, as shown and described.

(21) Appl. No.: **29/816,910**

(22) Filed: **Nov. 26, 2021**

(51) **LOC (13) Cl.** **D8/105**

(52) **U.S. Cl.**

USPC **D8/105; D8/76; D8/81**

(58) **Field of Classification Search**

USPC **D8/14, 51, 75, 76, 77, 80, 81, 105**

CPC .. **B25F 1/00; B25F 1/003; B25F 1/006; B25F
1/04**

See application file for complete search history.

DESCRIPTION

FIG. 1 is a perspective view of a multifunction tool showing my new design;
FIG. 2 is another perspective view thereof;
FIG. 3 is a front elevational view thereof;
FIG. 4 is a rear elevational view thereof;
FIG. 5 is a left side elevational view thereof;
FIG. 6 is a right side elevational view thereof;
FIG. 7 is a top plan view thereof;
FIG. 8 is a bottom plan view thereof;
FIG. 9 is a perspective view of the multifunction tool, wherein the two main components are separated;
FIG. 10 is a perspective view of the multifunction tool, wherein the two main components are separated, and the tool parts are shown in the open condition; and,
FIG. 11 is an enlarged view of portion 11 shown in FIG. 2.
The broken lines in the drawings depict portions of the multifunction tool that form no part of the claimed design. The dot-dash broken lines represent the boundary of the enlarged portion and form no part of the claimed design.

(56) **References Cited**

U.S. PATENT DOCUMENTS

D384,264 S *	9/1997	Liou	D8/55
D419,050 S *	1/2000	Lin	D8/55
D419,418 S *	1/2000	Lin	D8/55
D429,987 S *	8/2000	Hung	D8/81
D747,638 S	1/2016	Hernandez et al.		
D747,947 S	1/2016	Ma		
D808,764 S *	1/2018	Weinberger	D8/105
D826,666 S *	8/2018	Zhang	D8/55
D915,861 S *	4/2021	Zhong	D8/75
D933,446 S *	10/2021	Liu	D8/81
D950,351 S *	5/2022	Li	D8/81
D951,056 S *	5/2022	Li	D8/105

1 Claim, 11 Drawing Sheets

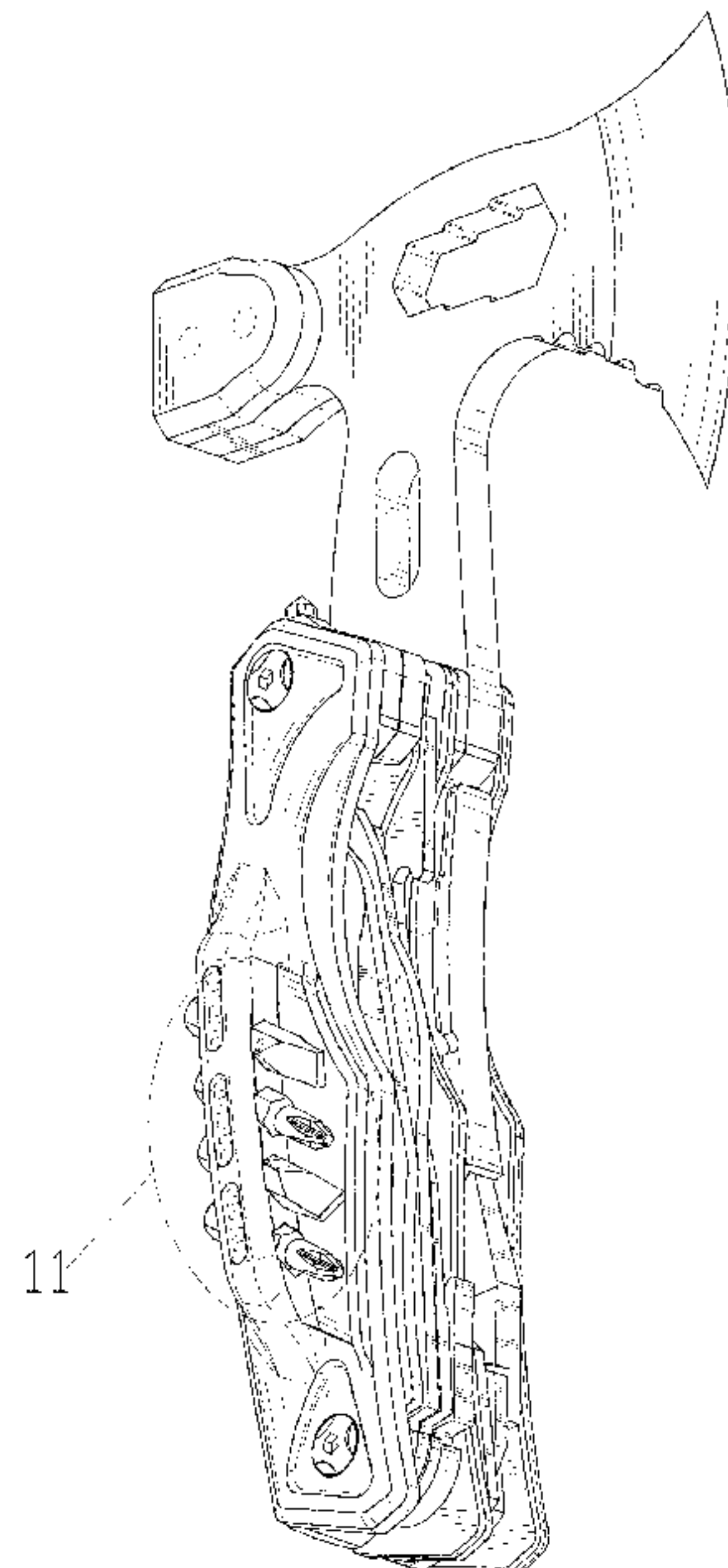

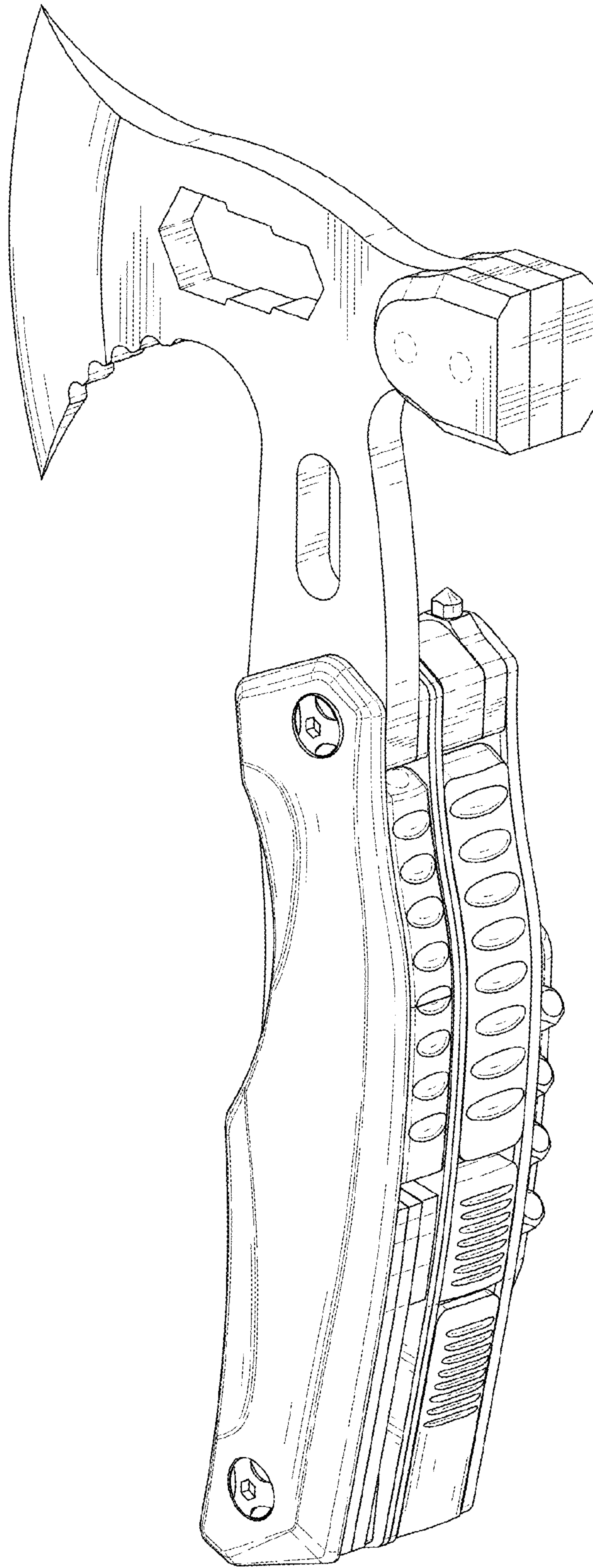

FIG. 1

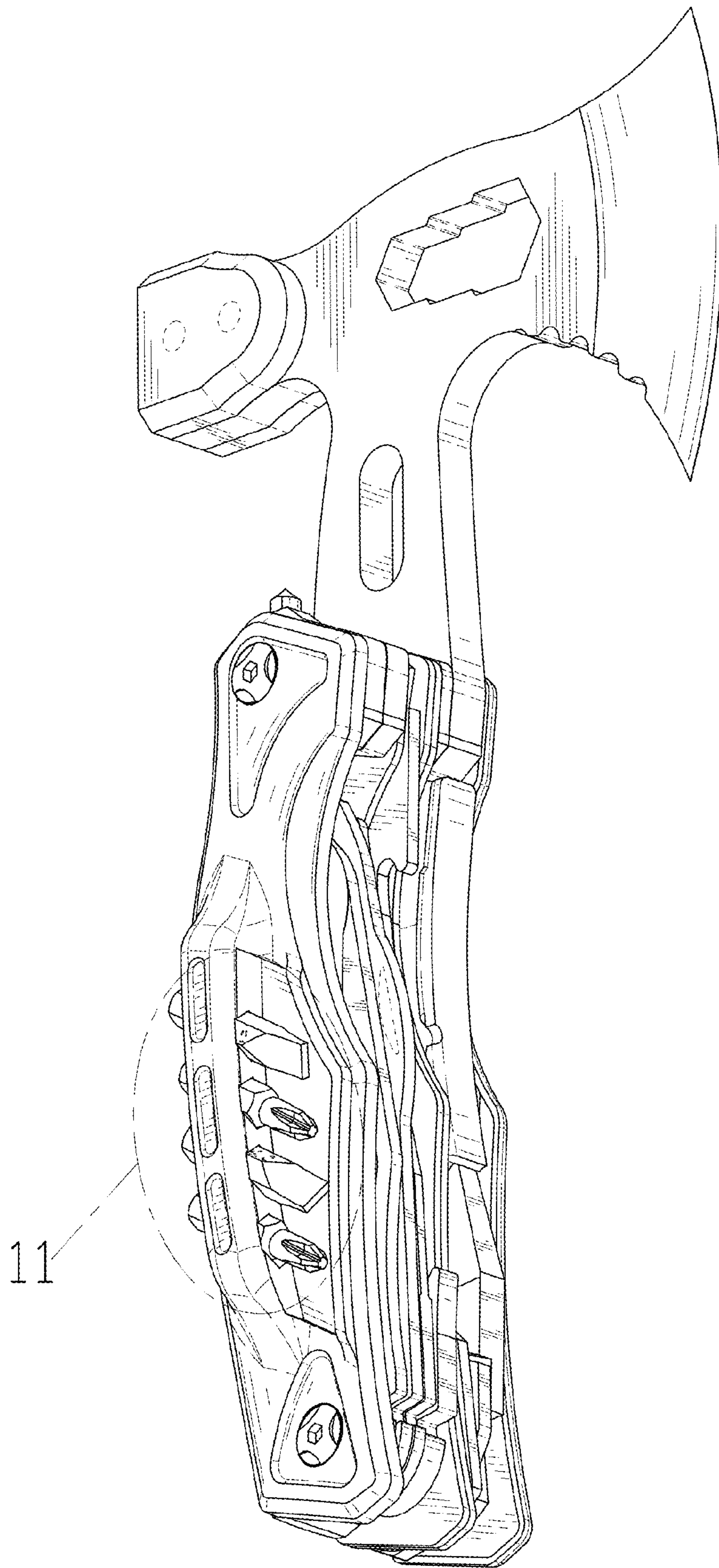

FIG. 2

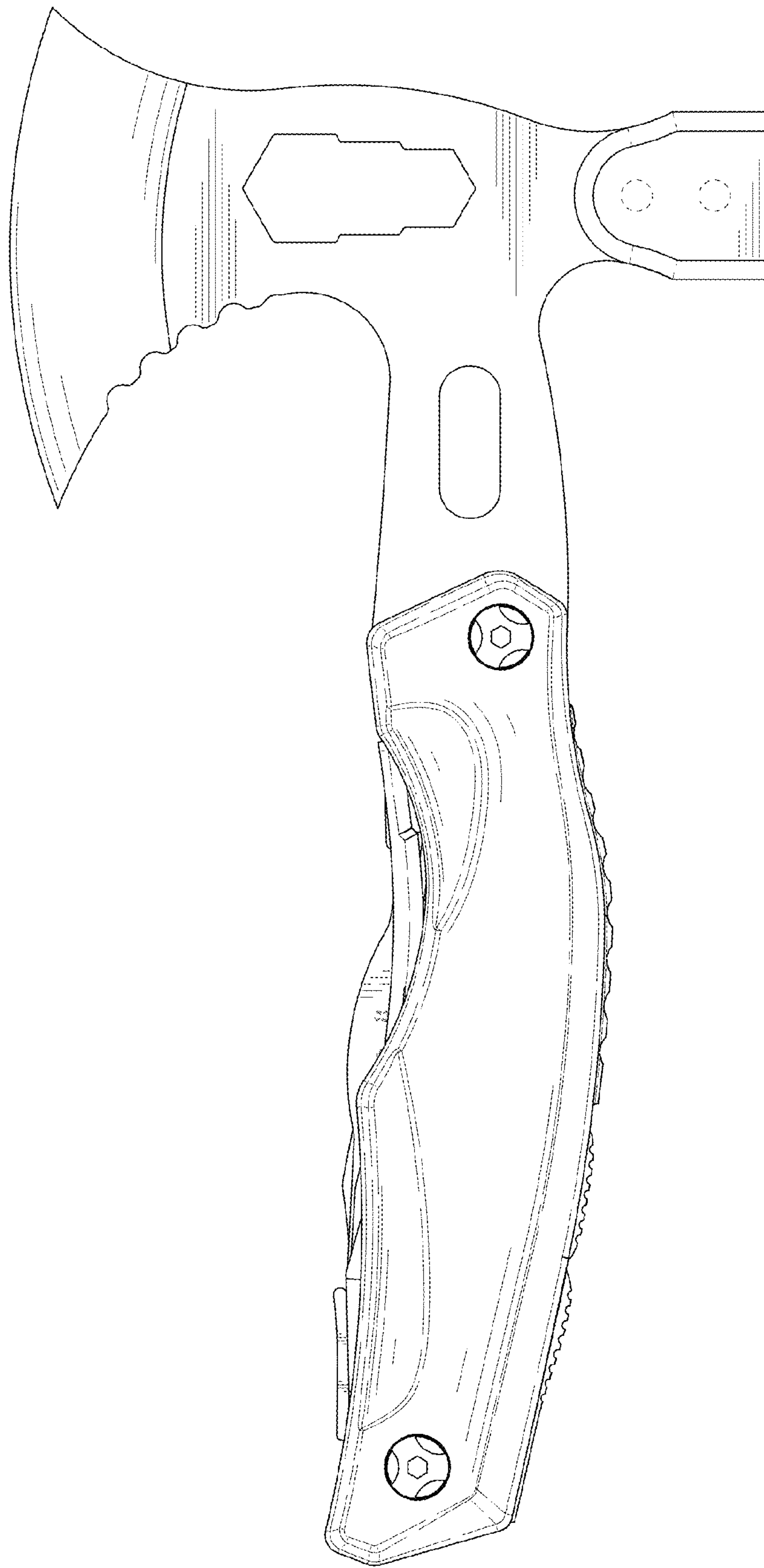

FIG. 3

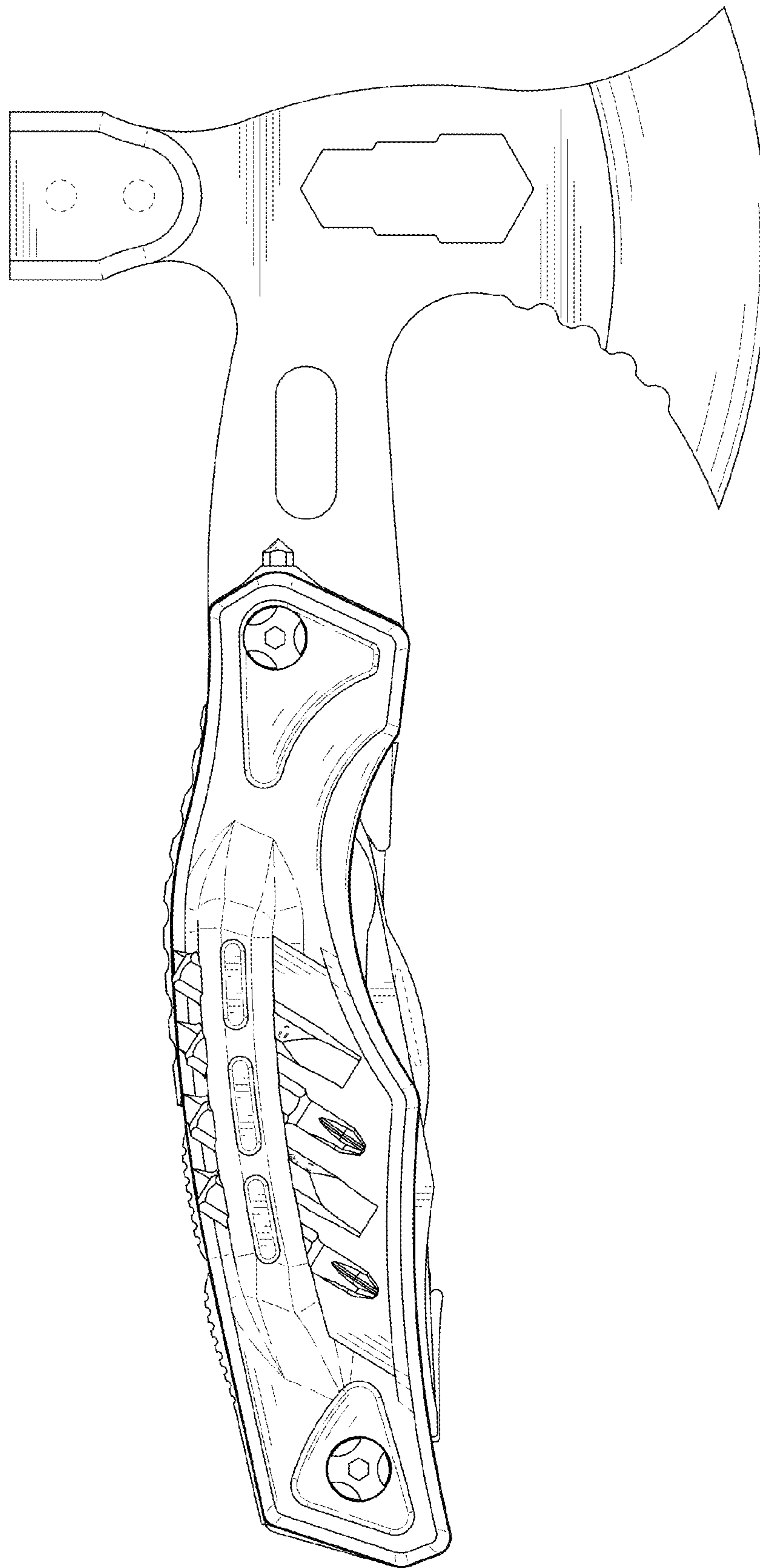

FIG. 4

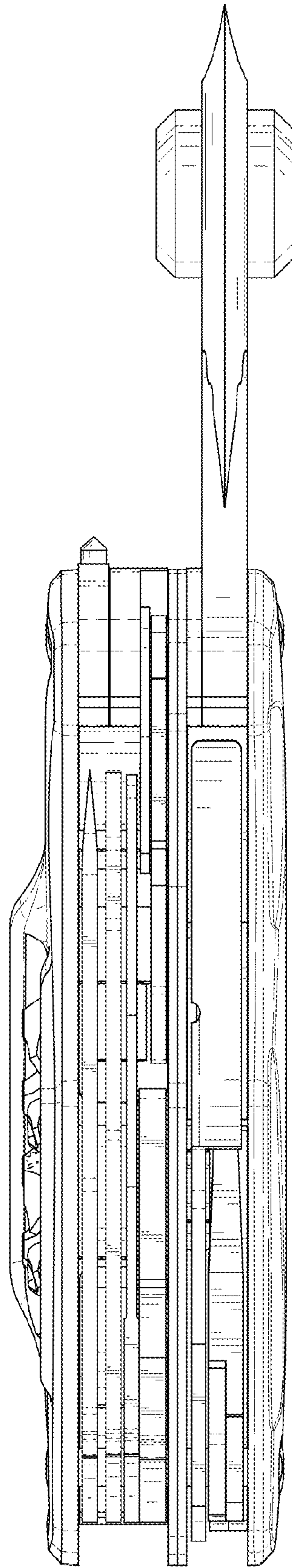

FIG. 5

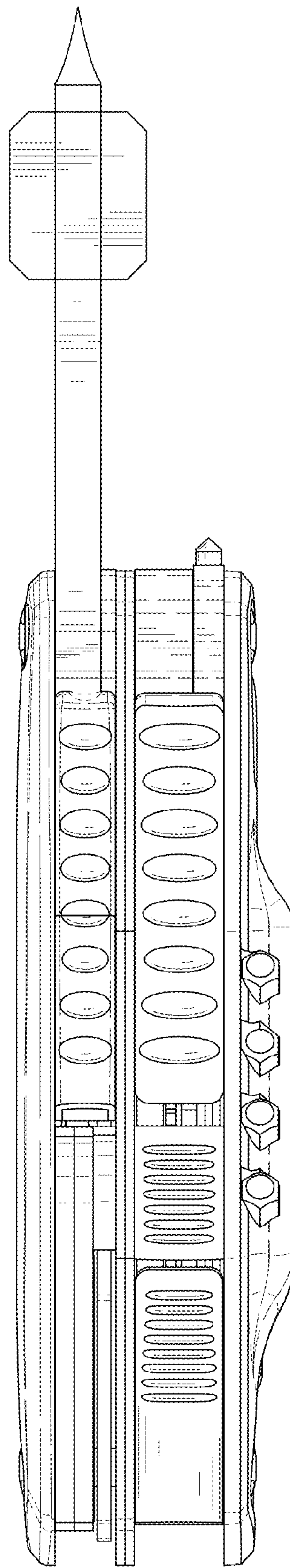

FIG. 6

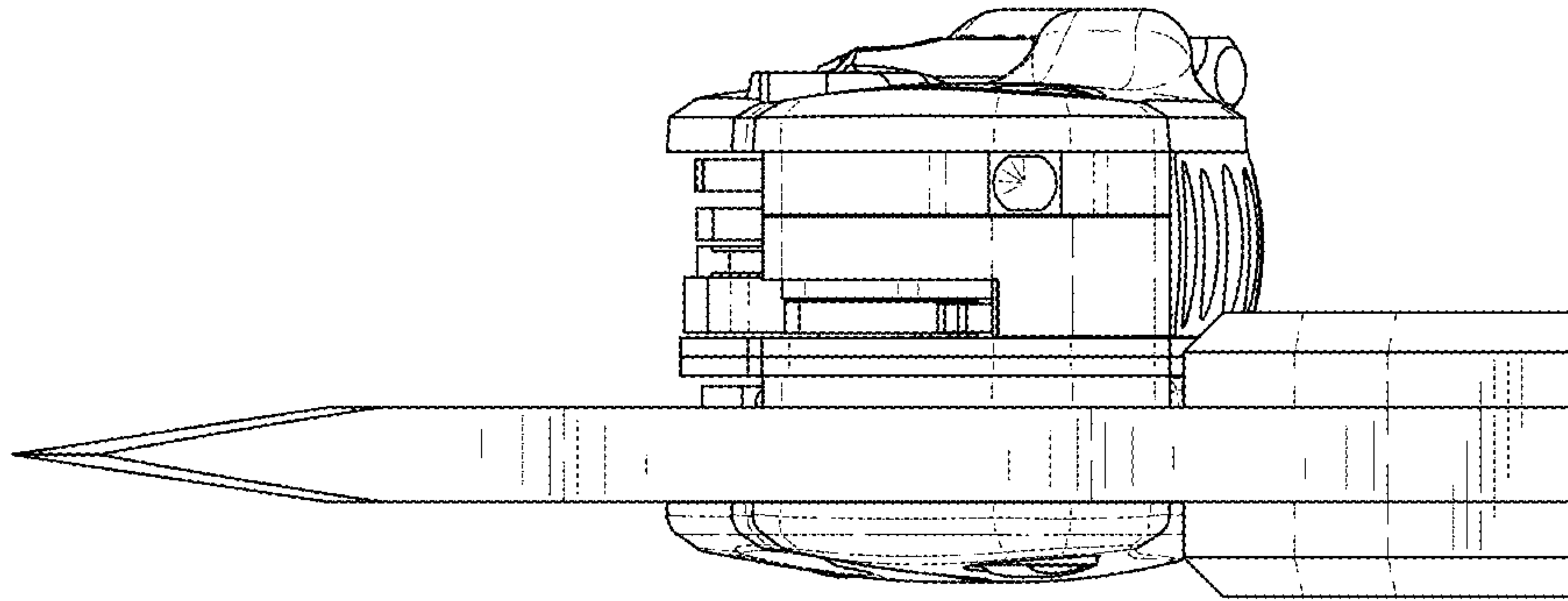

FIG. 7

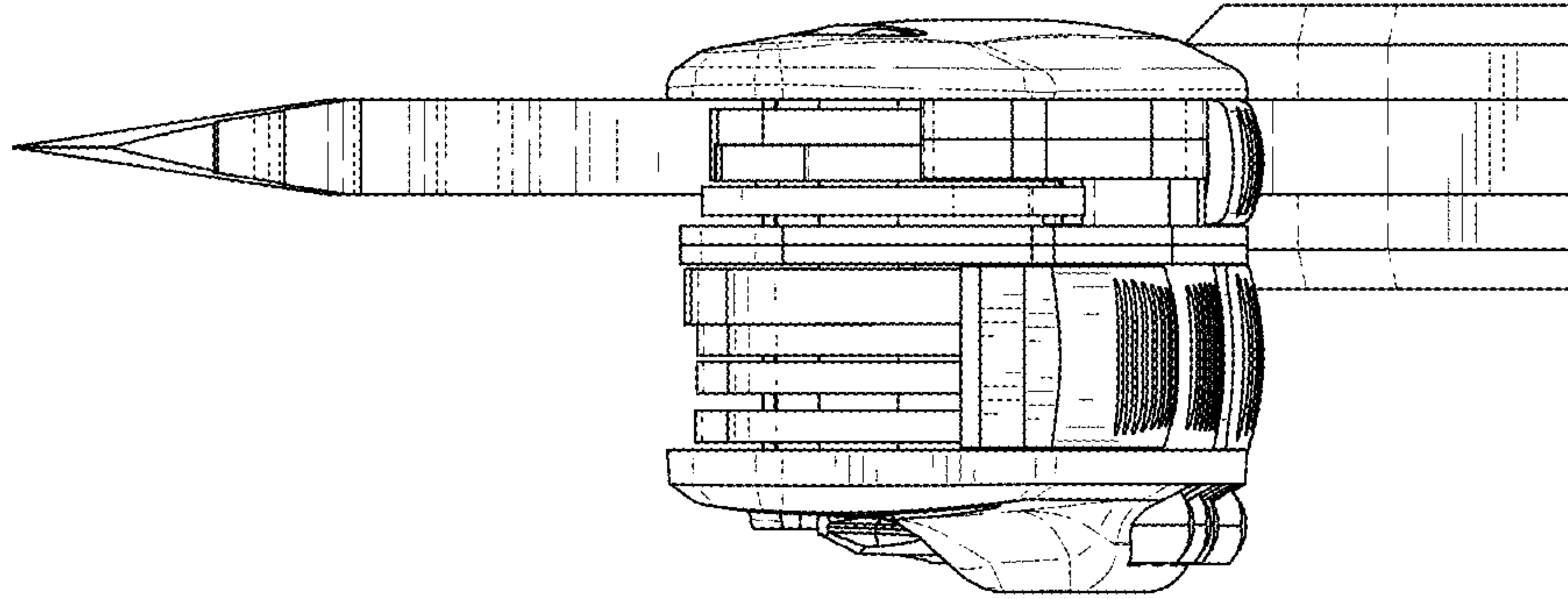

FIG. 8

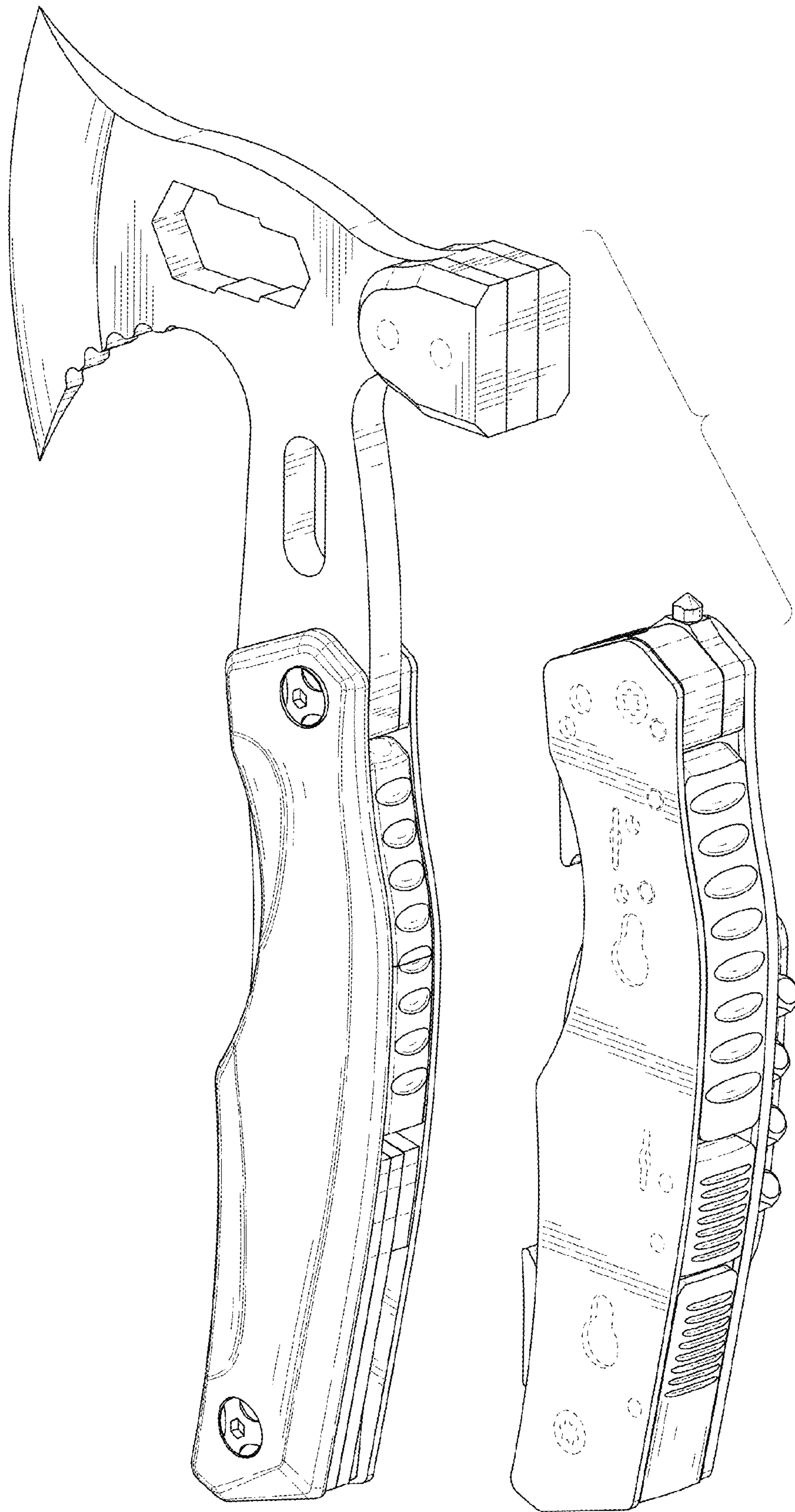

FIG. 9

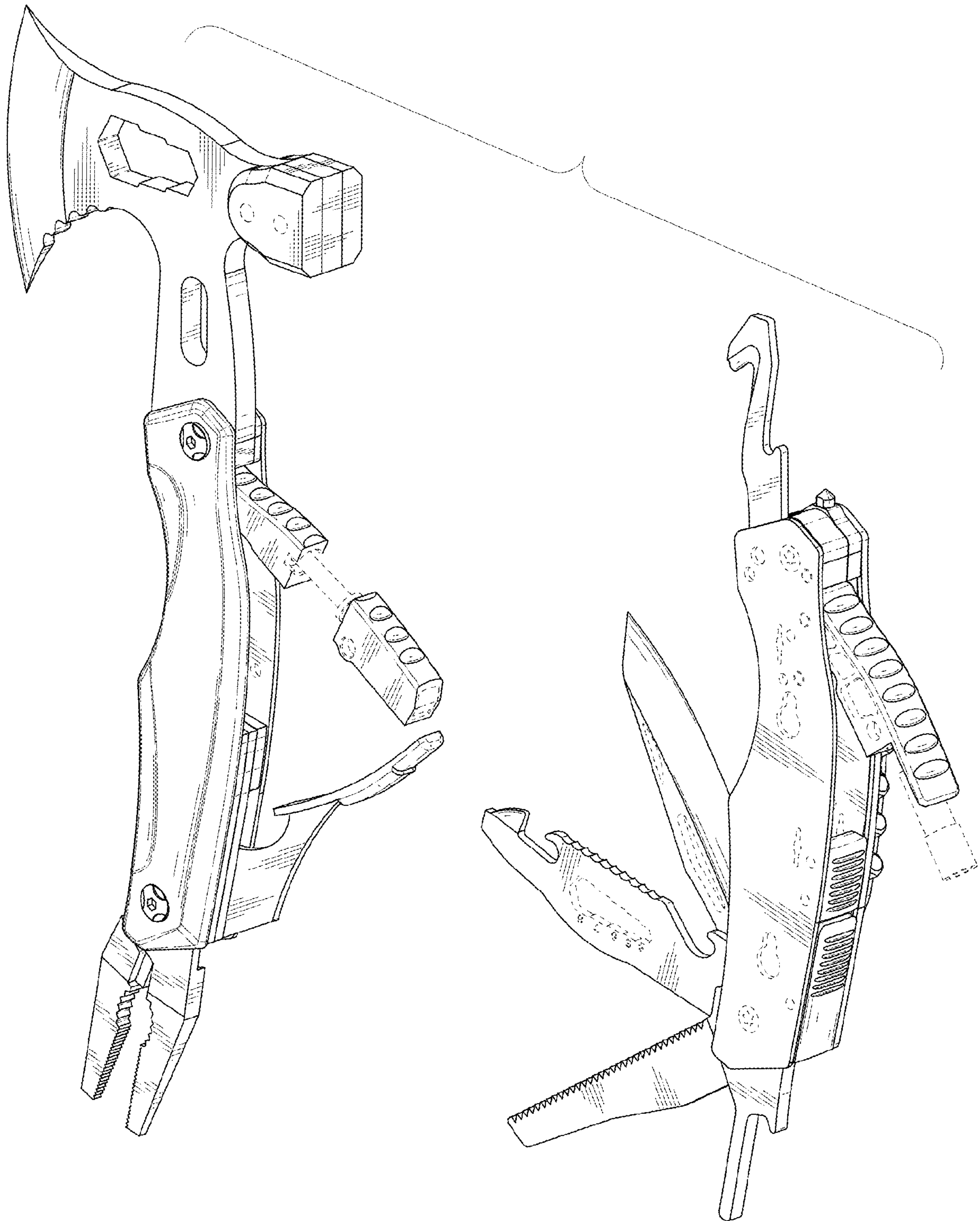

FIG. 10

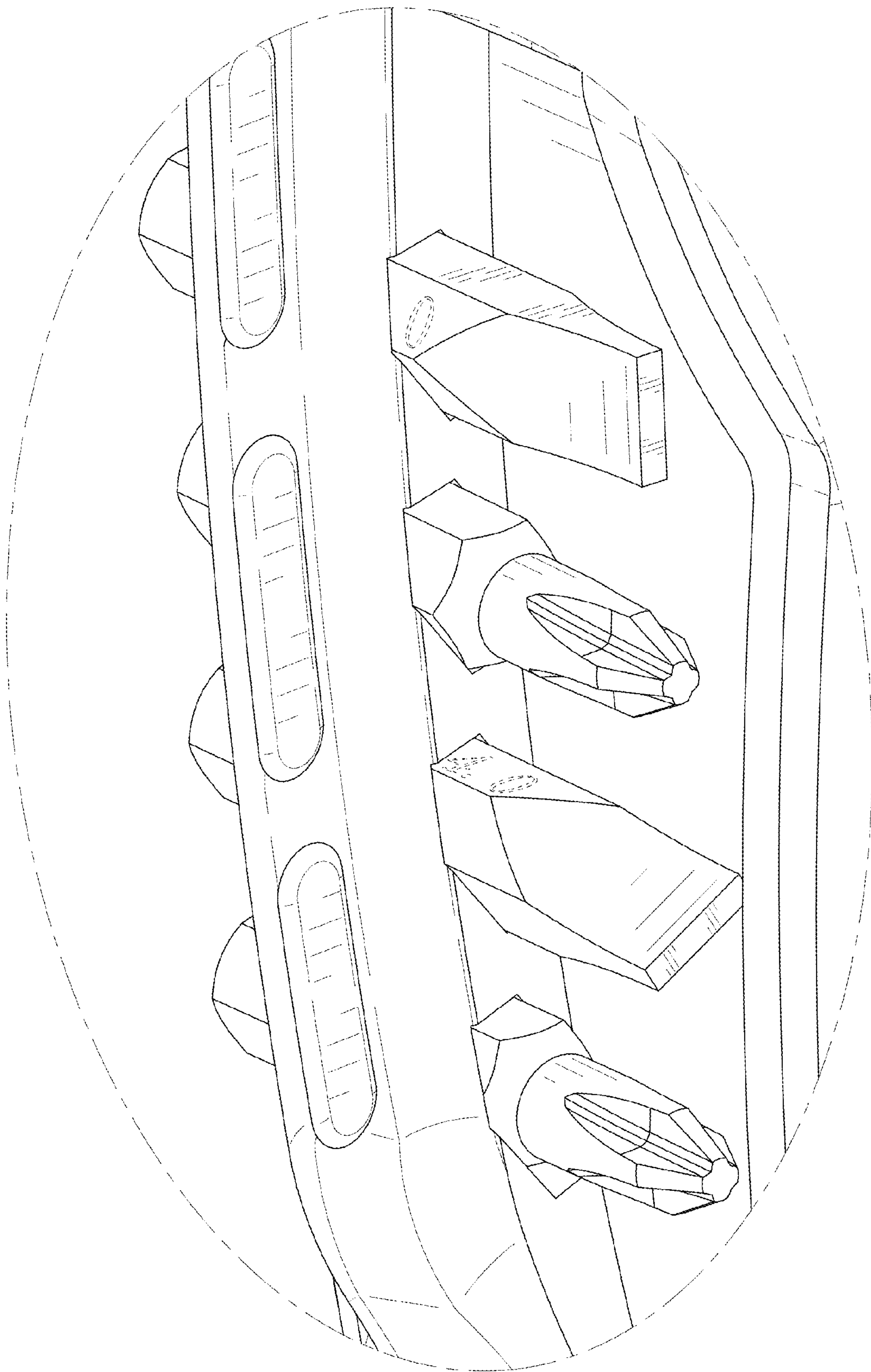

FIG. 11