



US00D959926S

(12) **United States Design Patent** (10) **Patent No.:** **US D959,926 S**
Hong et al. (45) **Date of Patent:** **** Aug. 9, 2022**

(54) **DISPOSABLE KNIFE**

D303,603 S * 9/1989 Zimmerman D7/696
D385,159 S * 10/1997 Gagnon D7/650
D516,392 S * 3/2006 de Vries D7/688

(71) Applicant: **URIPACKAGE CO., LTD.**,
Gyeonggi-do (KR)

(Continued)

(72) Inventors: **In Pyo Hong**, Gyeonggi-do (KR); **Se Hwan Shin**, Incheon (KR)

FOREIGN PATENT DOCUMENTS

EM 007839014-0015 * 4/2020
KR 301077537.0000 * 9/2020
WO WOD065432-005 * 11/2013

(73) Assignees: **URIPACKAGE CO., LTD.**,
Gyeonggi-Do (KR); **Se Hwan Shin**,
Incheon (KR)

OTHER PUBLICATIONS

Faithful Supply Cutlery Set, posted at Amazon.com on Jun. 8, 2018
, [site visited Feb. 25, 2022], Available from internet, URL: <https://
www.amazon.com/Faithful-Supply-Individually-Utensils-Silverware/
dp/B07GKF8PP9/> (Year: 2018).*

(**) Term: **15 Years**

(Continued)

(21) Appl. No.: **29/749,840**

(22) Filed: **Sep. 9, 2020**

(51) **LOC (13) Cl.** **07-03**

Primary Examiner — Andrew Kerr

(52) **U.S. Cl.**
USPC **D7/650**

Assistant Examiner — Chariton Alexakis

(58) **Field of Classification Search**

(74) *Attorney, Agent, or Firm* — IPLA P.A.

USPC D7/213, 381, 393, 394, 395, 396.1,
D7/401.2, 589, 642, 643, 644, 645, 646,
D7/647, 648, 649, 650, 651, 652, 664,
D7/669, 670, 673, 693, 696; D8/93, 97,
D8/98, 99, 100, 107, 300, 321;
D10/46.2; D21/532, 567, 568; D22/117,
D22/118
CPC A22C 25/006; A47G 21/02; A47G 21/06;
A47G 21/065; A47G 21/08; B21D 53/64;
B26B 1/00; B26B 1/08; B26B 1/10;
B26B 3/00; B26B 3/02; B26B 3/03;
B26B 3/04; B26B 3/06; B26B 5/00;
B26B 9/00; B26B 9/02

(57) **CLAIM**

The ornamental design for a disposable knife, as shown and
described.

See application file for complete search history.

DESCRIPTION

FIG. 1 is a perspective view of my new design showing a
disposable knife;
FIG. 2 is another perspective view of my new design
showing a disposable knife;
FIG. 3 is a front elevation view of FIG. 1;
FIG. 4 is a rear elevation view of FIG. 1;
FIG. 5 is an enlarged elevation view of V in FIG. 1;
FIG. 6 is an enlarged cross section taken along VI-VI in FIG.
3; and,
FIG. 7 is an enlarged cross section taken along VII-VII in
FIG. 3.

The short dash-long dash broken lines in FIGS. 1 and 5,
designating the boundary of the enlarged view, form no part
of the claimed design.

(56) **References Cited**

U.S. PATENT DOCUMENTS

D219,859 S * 2/1971 Abel D7/650
D252,315 S * 7/1979 Dart D7/650

1 Claim, 5 Drawing Sheets

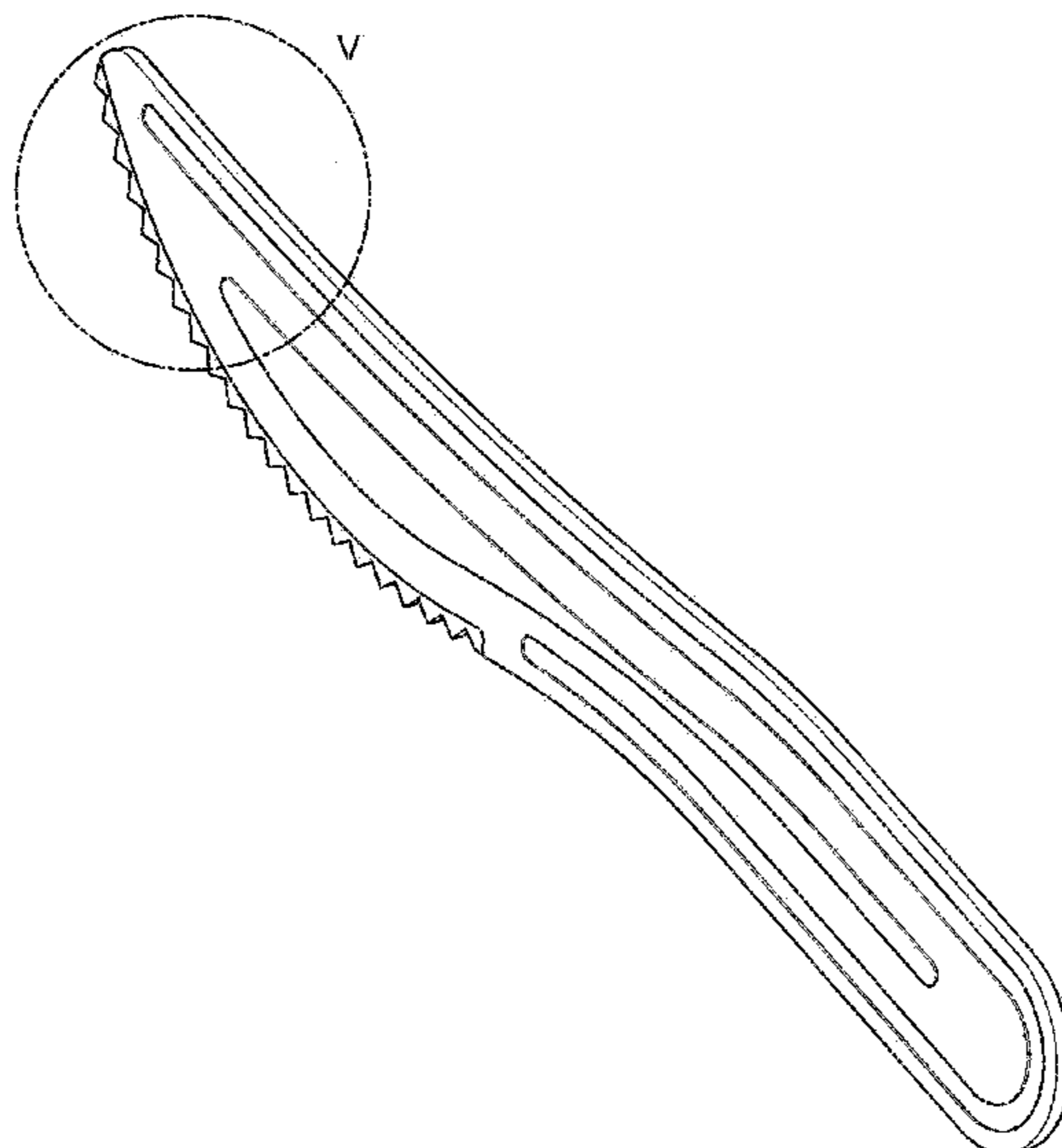

(56)

References Cited

U.S. PATENT DOCUMENTS

D623,907 S * 9/2010 Lenge D7/649
D634,577 S * 3/2011 Oakes D7/649
D634,974 S * 3/2011 Oakes D7/649
D663,581 S * 7/2012 Oakes D7/649
D700,811 S * 3/2014 Lin D7/645
D795,656 S * 8/2017 McFarland D7/645
D849,475 S * 5/2019 Liming D7/649
D852,006 S * 6/2019 Oakes D7/645
D911,785 S * 3/2021 Gallop D7/645
D915,836 S * 4/2021 Henderson D7/645

OTHER PUBLICATIONS

Eqoware Compostable Knives, posted at Amazon.com on Apr. 8, 2019, [site visited Feb. 25, 2022], Available from internet, URL:<<https://www.amazon.com/Certified-Compostable-Convenient-Design-led-Disposable/dp/B07QJ2CPCQ/Eqoware>> (Year: 2019).*

Compostable Disposable Knives, posted at Amazon.com on May 27, 2020, [site visited Feb. 25, 2022], Available from internet, URL:<<https://www.amazon.com/dp/B0868WDW4G/>> (Year: 2020).*

Sugarcane Bagasse Disposable Cutlery Set, posted at m.made-in-china.com (Date Not Available), [site visited Feb. 25, 2022], Available from internet, URL:<<https://m.made-in-china.com/product/Biodegradable-Sugarcane-Bagasse-Disposable-Cutlery-Set-Compostable-Knife-1918553872.html#>> (Year: NA).*

* cited by examiner

FIG. 1

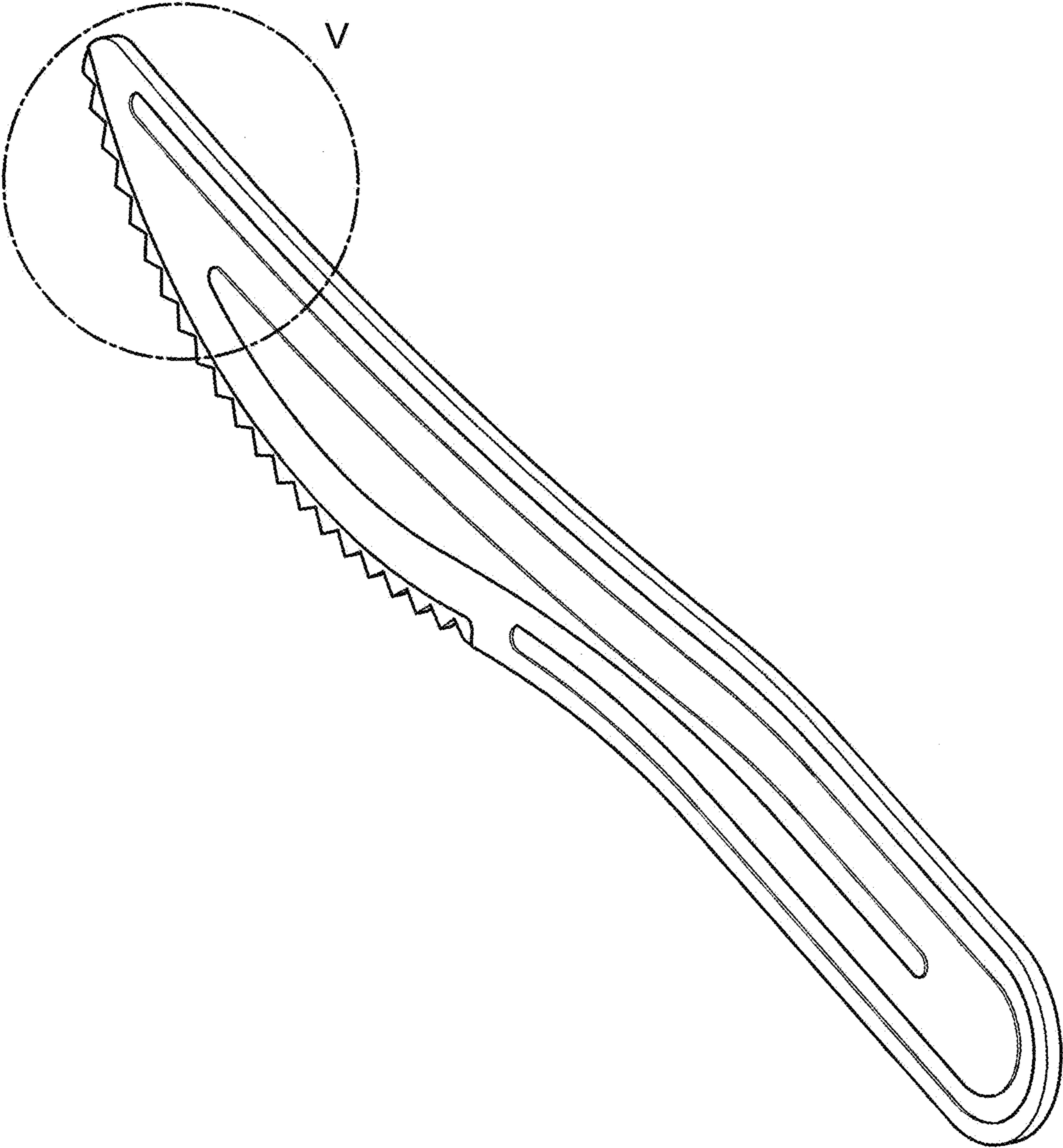

FIG. 2

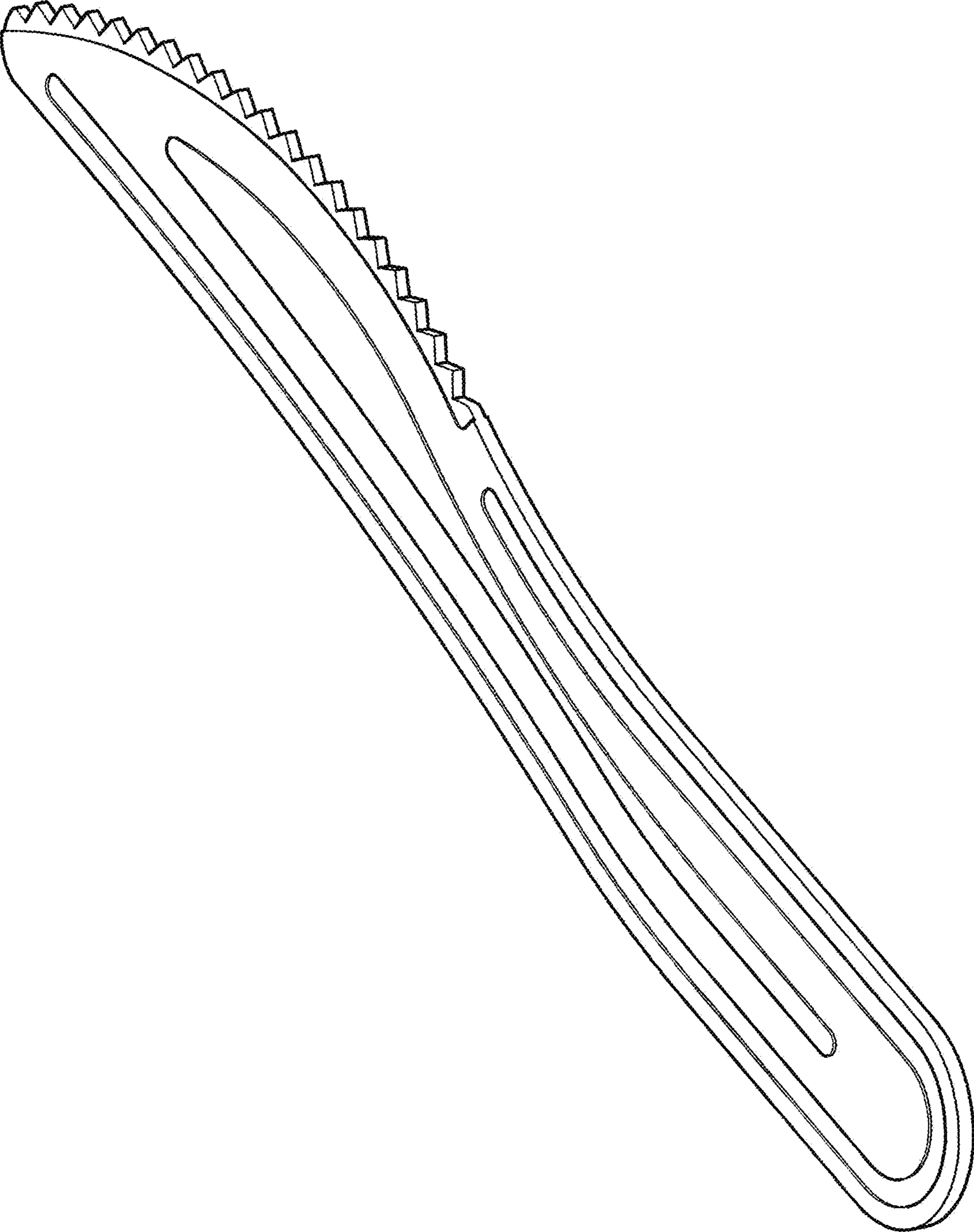

FIG. 3

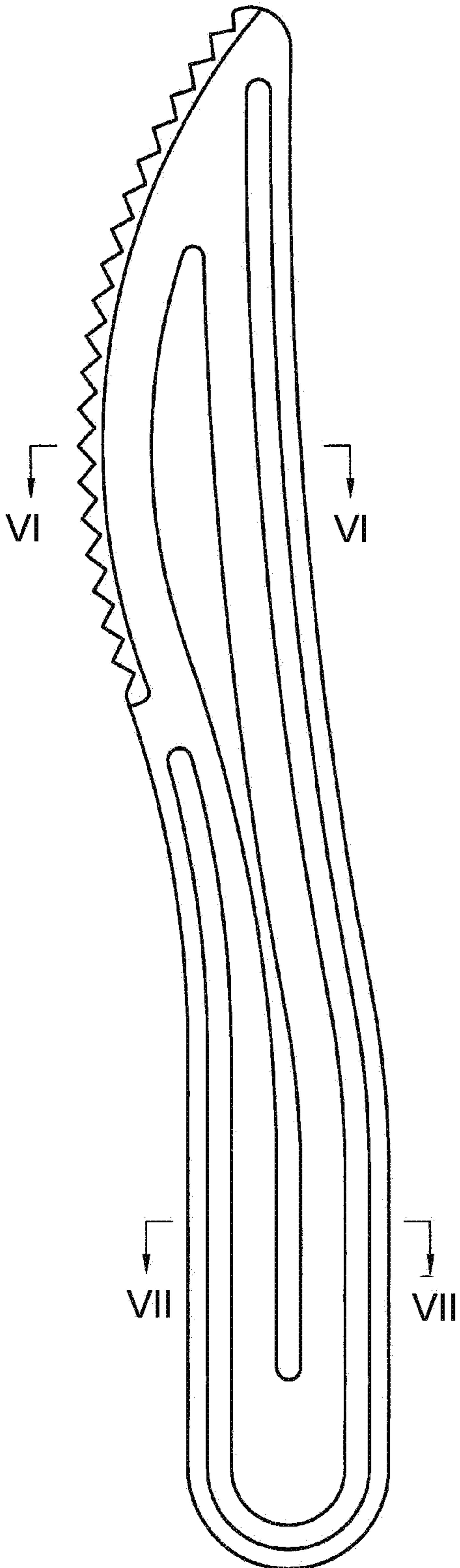

FIG. 4

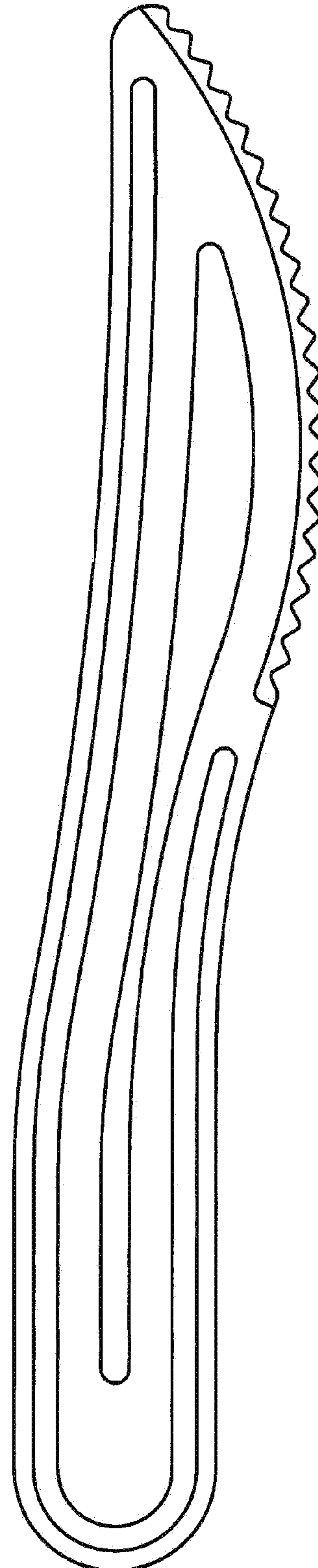

FIG. 5

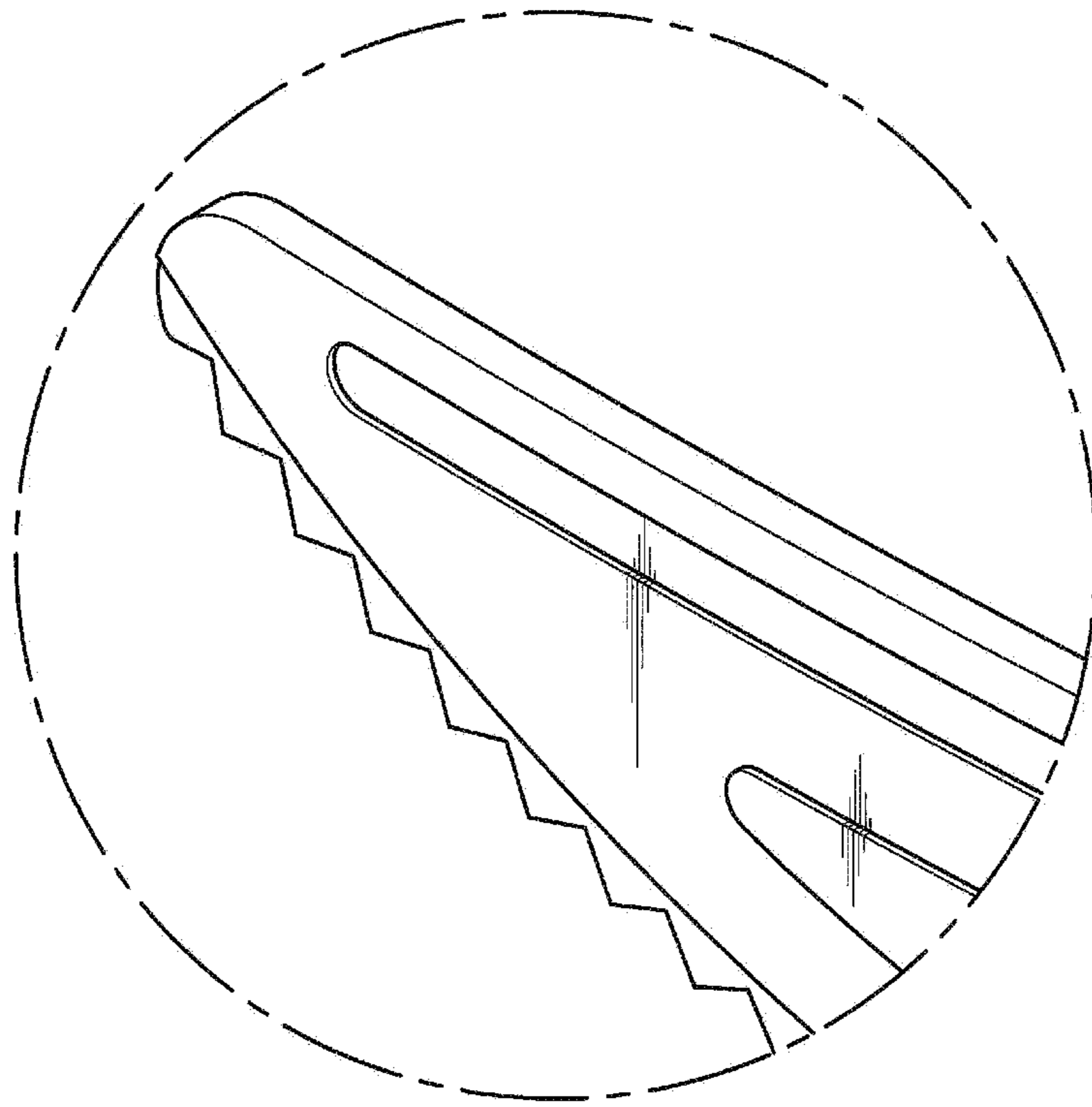

FIG. 6

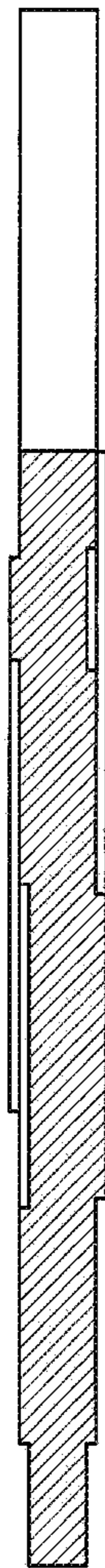

FIG. 7

