



US00D959920S

(12) **United States Design Patent**
Nassanian

(10) **Patent No.:** **US D959,920 S**

(45) **Date of Patent:** **** Aug. 9, 2022**

(54) **COOLER**

(71) Applicant: **Earth Pak, LLC**, Alhambra, CA (US)

(72) Inventor: **Hrag Nassanian**, Portland, OR (US)

(73) Assignee: **Earth Pak, LLC**, Alhambra, CA (US)

(**) Term: **15 Years**

(21) Appl. No.: **29/802,641**

(22) Filed: **Aug. 6, 2021**

(51) **LOC (13) Cl.** **07-01**

(52) **U.S. Cl.**
USPC **D7/607; D3/216**

(58) **Field of Classification Search**

USPC D3/215–217, 315, 318, 233, 267, 283,
D3/289, 276, 268; D7/605–607, 709, 710
CPC F25D 3/08; F25D 3/02; F25D 3/04; F25D
3/06; F25D 3/14; F25D 3/107; F25D
2331/804; F25D 2331/801; B65D 81/38;
B65D 81/3813; B65D 81/3816; B65D
81/3818; B65D 81/382; B65D 81/3825;
B65D 81/3827; B65D 81/383; B65D
81/3848; B65D 81/3851; B65D 81/3853;
B65D 81/3855; B65D 81/3858; B65D
81/386; B65D 81/3862; A45C 11/20;
A45C 3/00; A45C 3/001; A45C
2003/008; A45C 5/06; A45F 3/04

See application file for complete search history.

(56) **References Cited**

U.S. PATENT DOCUMENTS

D465,134 S * 11/2002 Joss D3/289
D764,873 S * 8/2016 Collie D7/607
D772,562 S 11/2016 Petre
D824,660 S * 8/2018 Ross D3/217
D828,112 S 9/2018 Furneaux et al.
D834,895 S 12/2018 Triska et al.

(Continued)

OTHER PUBLICATIONS

Amazon.com, Earth Pak Heavy Duty Waterproof 20-Can Soft Cooler Bag, Brand: Earth Pak, ASIN: B09D93HDCJ, pp. 1-8, earliest date available Aug. 10, 2020. (Year: 2020).*

(Continued)

Primary Examiner — Terry A Wallace

(74) *Attorney, Agent, or Firm* — Downs Rachlin Martin PLLC

(57) **CLAIM**

The ornamental design for a cooler, as shown and described.

DESCRIPTION

FIG. 1 is a perspective view of a first embodiment of a cooler showing my new design;
FIG. 2 is a front view thereof;
FIG. 3 is a rear view thereof;
FIG. 4 is a right side view thereof;
FIG. 5 is a left side view thereof;
FIG. 6 is a top view thereof;
FIG. 7 is a front view of a second embodiment of a cooler showing my new design;
FIG. 8 is a rear view thereof;
FIG. 9 is a right side view thereof;
FIG. 10 is a left side view thereof; and,
FIG. 11 is a top view thereof.

The dash-dash-dash broken lines in the Figures are for the purpose of illustrating unclaimed portions of the cooler and form no part of the claimed design.

The dash-dot-dash broken lines are boundary lines. It is understood that the claimed design extends to the boundary lines but the boundary lines form no part of the claimed design.

The bottom view forms no part of the claimed design.

The stippling in the Figures are not surface ornamentation and do not indicate a particular material, color, or surface finish.

1 Claim, 11 Drawing Sheets

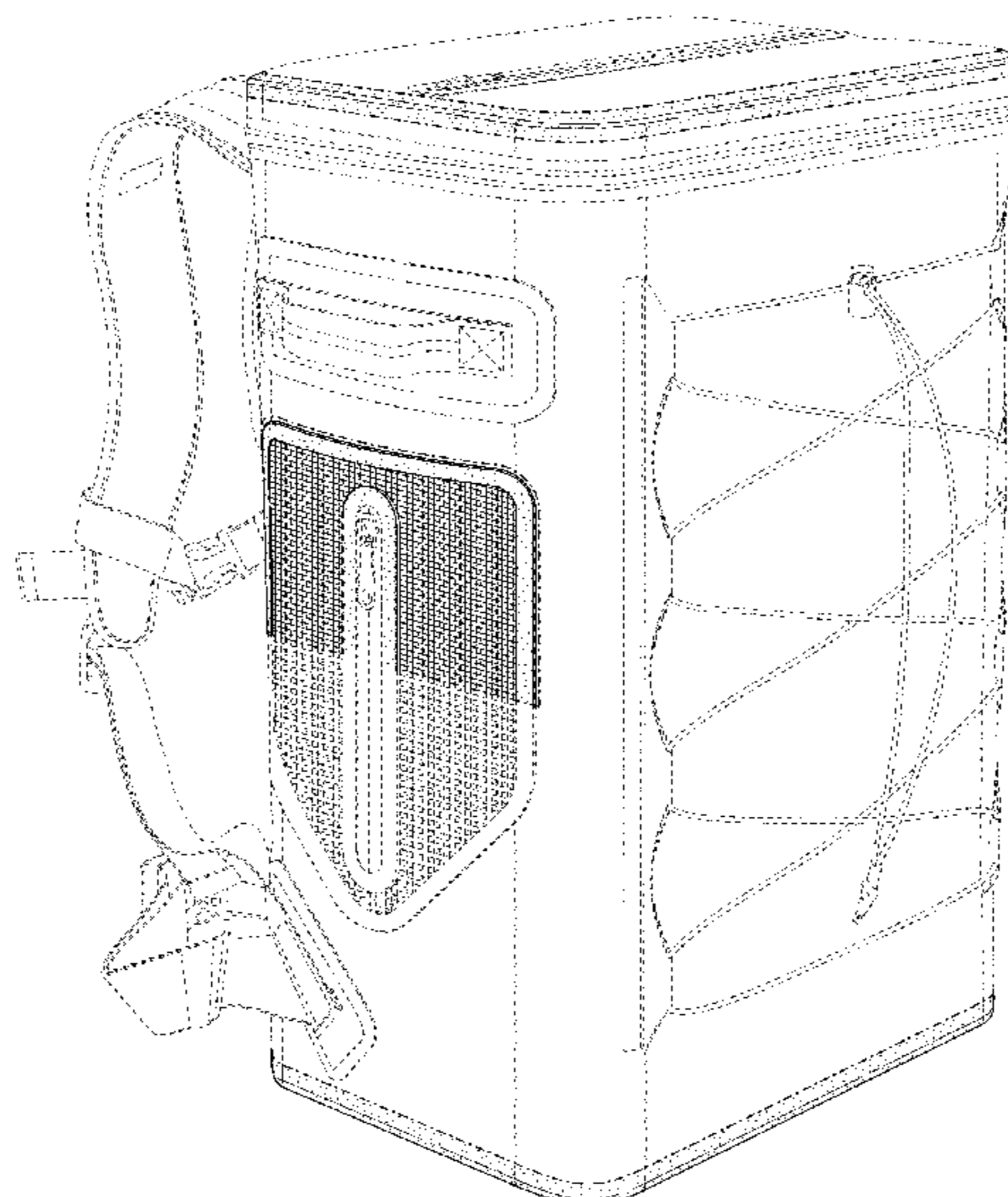

(56)

References Cited

U.S. PATENT DOCUMENTS

D840,194 S	2/2019	Furneaux et al.	
D848,220 S	5/2019	Munie et al.	
D848,221 S	5/2019	Munie et al.	
D848,222 S	5/2019	Munie et al.	
D848,223 S	5/2019	Munie et al.	
D848,798 S	5/2019	Munie et al.	
D849,486 S	5/2019	Munie et al.	
D855,310 S *	8/2019	Gonzales	A45F 3/04 D3/217
D871,163 S	12/2019	Jacobsen	
D921,440 S	6/2021	Munie et al.	
2005/0056669 A1 *	3/2005	Lavelle	A41D 15/04 224/153
2005/0133399 A1 *	6/2005	Fidrych	A45F 3/04 206/545
2007/0237432 A1 *	10/2007	Mogil	A45C 7/0077 383/38
2018/0087819 A1 *	3/2018	Triska	A45C 13/008

OTHER PUBLICATIONS

<https://www.hydroflask.com/22-l-soft-cooler-pack>; Hydro Flask Cooler Backpack; as downloaded on Jul. 29, 2021.

https://www.tourit.com/products/voyager-backpack?currency=USD&variant=28165019664477&utm_medium=cpc&utm_source=google&utm_campaign=Google%20Shopping&gclid=Cj0KCCQjw6NmHBhD2ARIsAI3hrM1U16kW2p6bf3XL8MMvKwES8x0bWiO-twP4lulDZYSHRHA8mL-Wnn0aAoMKEALw_wcB; Tourit Cooler Backpack; as downloaded on Jul. 29, 2021.

https://www.yeti.com/en_US/coolers/soft-coolers/backpack/18050125000.html#pos=4; Yeti Cooler Backpack; as downloaded on Jul. 29, 2021.

Instagram Post from Jun. 26, 2020; theearthpak; Earth Pak; Loch Series Cooler.

Instagram Post from Jun. 11, 2020; theearthpak; Earth Pak; Loch Series Soft Cooler.

* cited by examiner

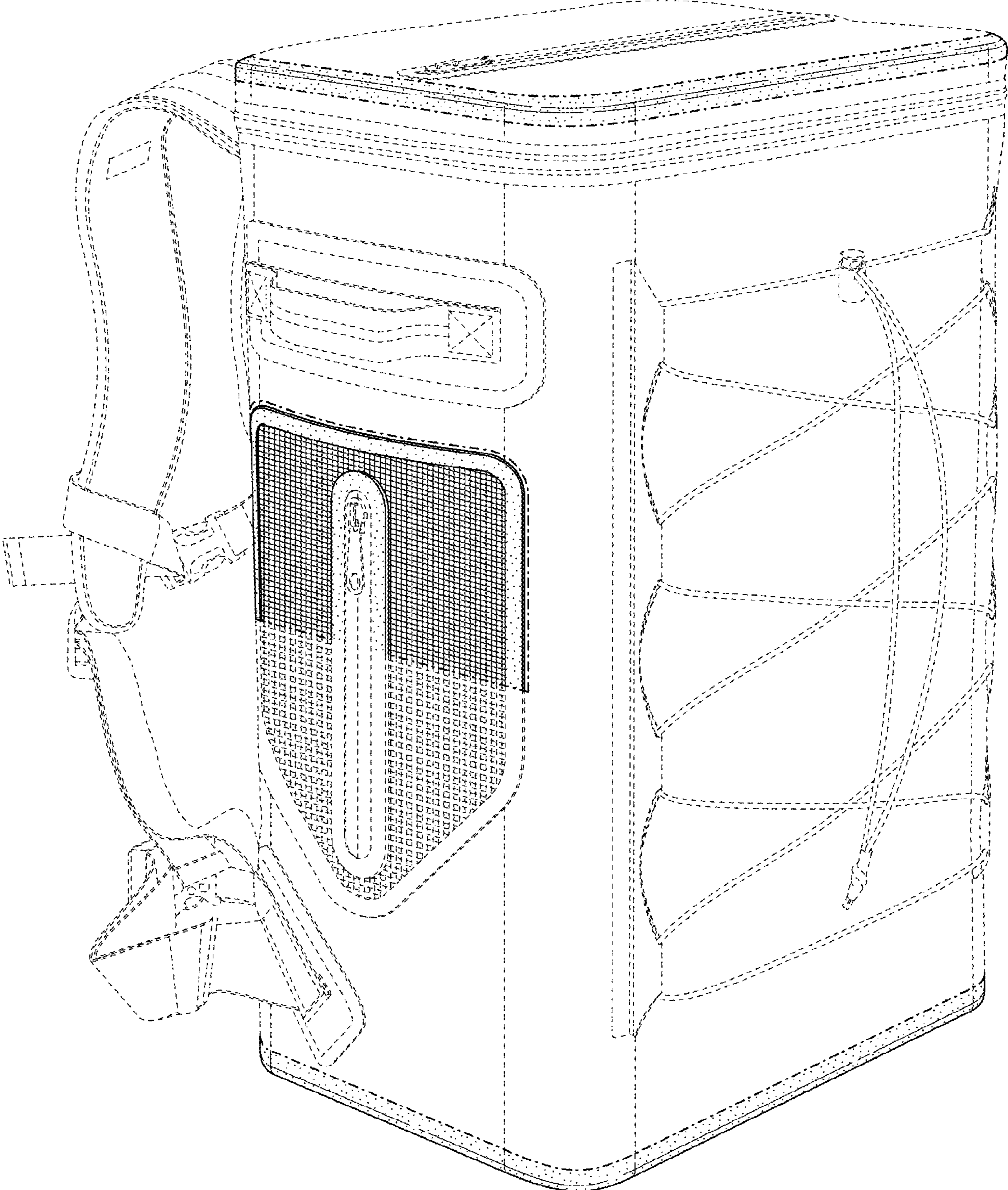

FIG. 1

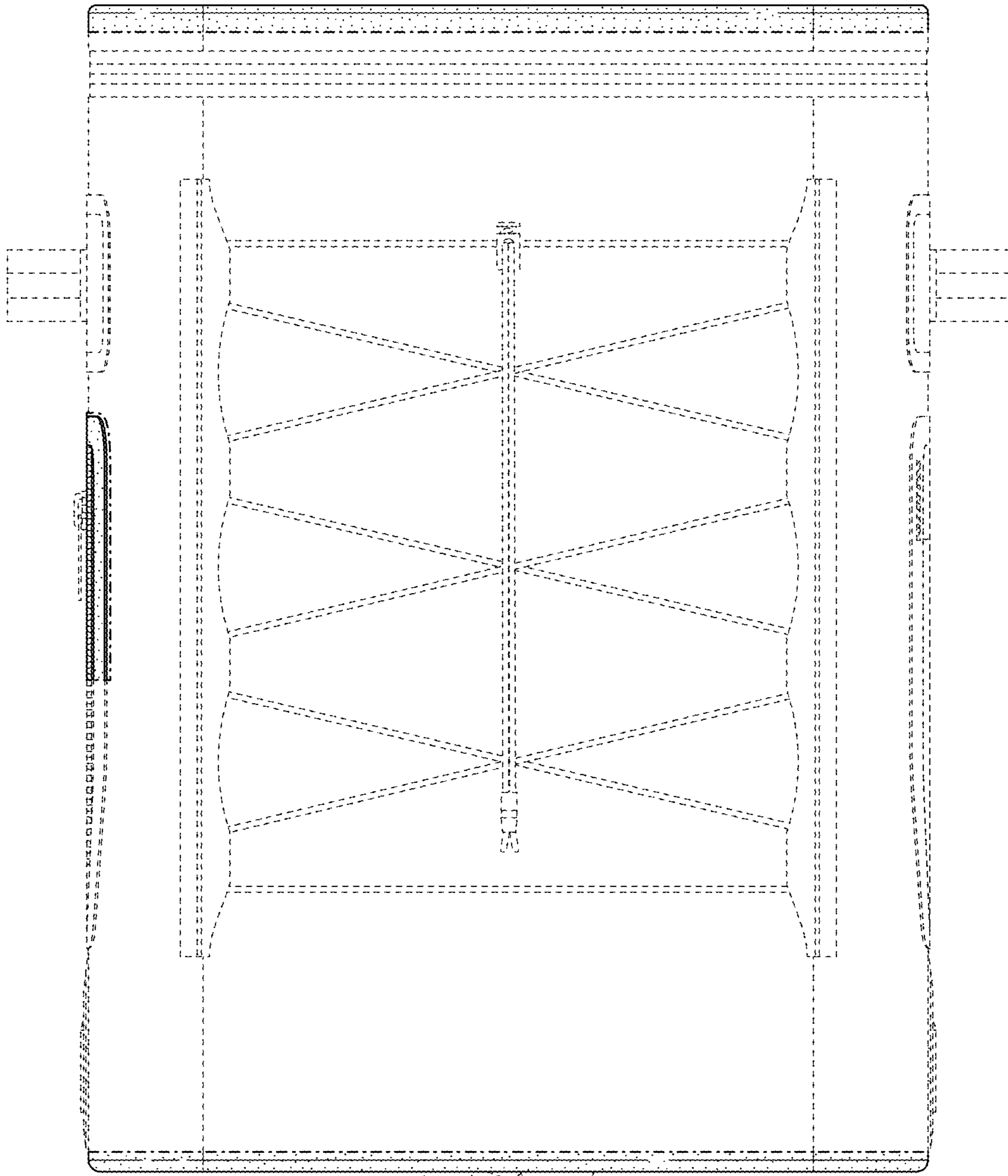

FIG. 2

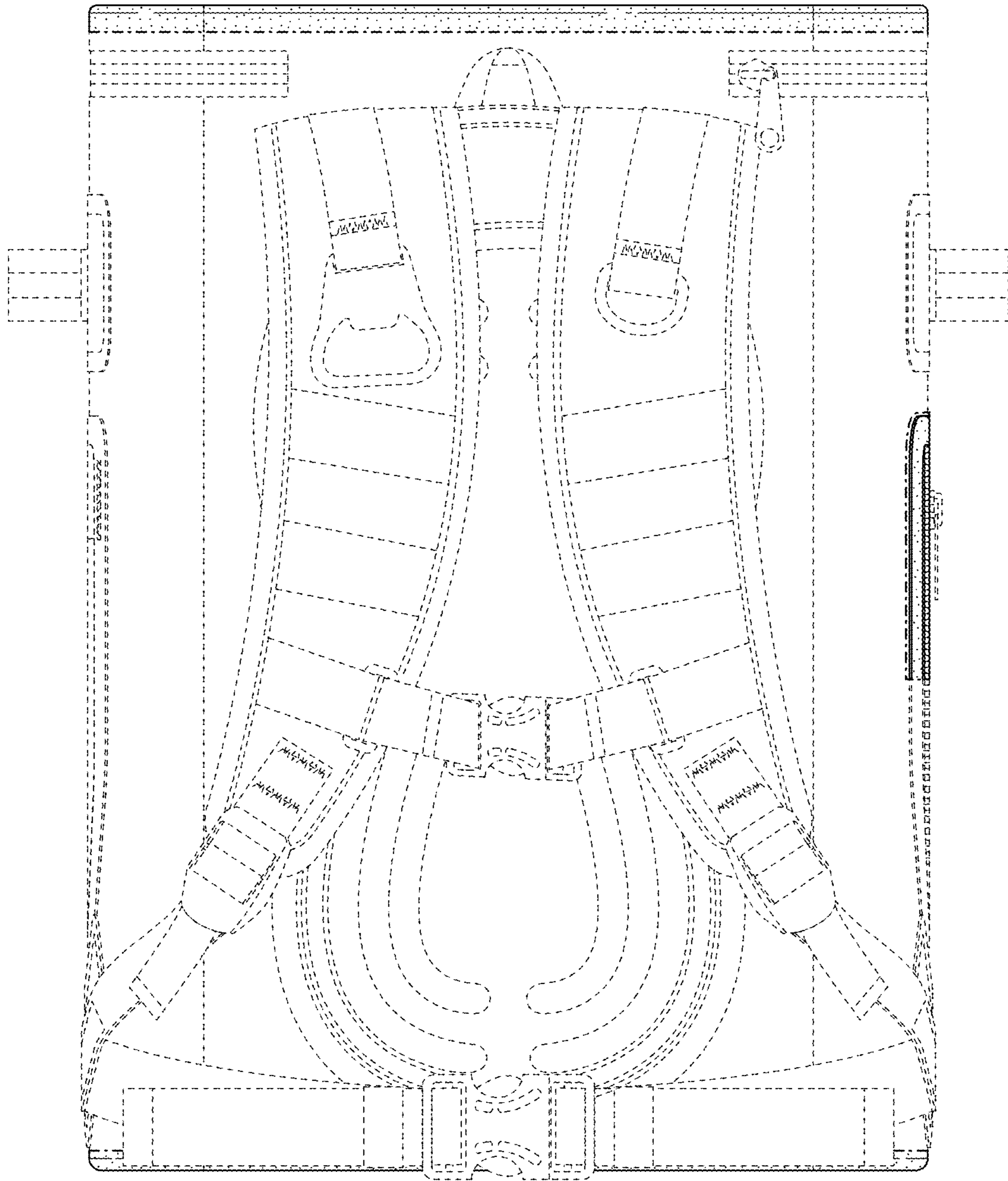

FIG. 3

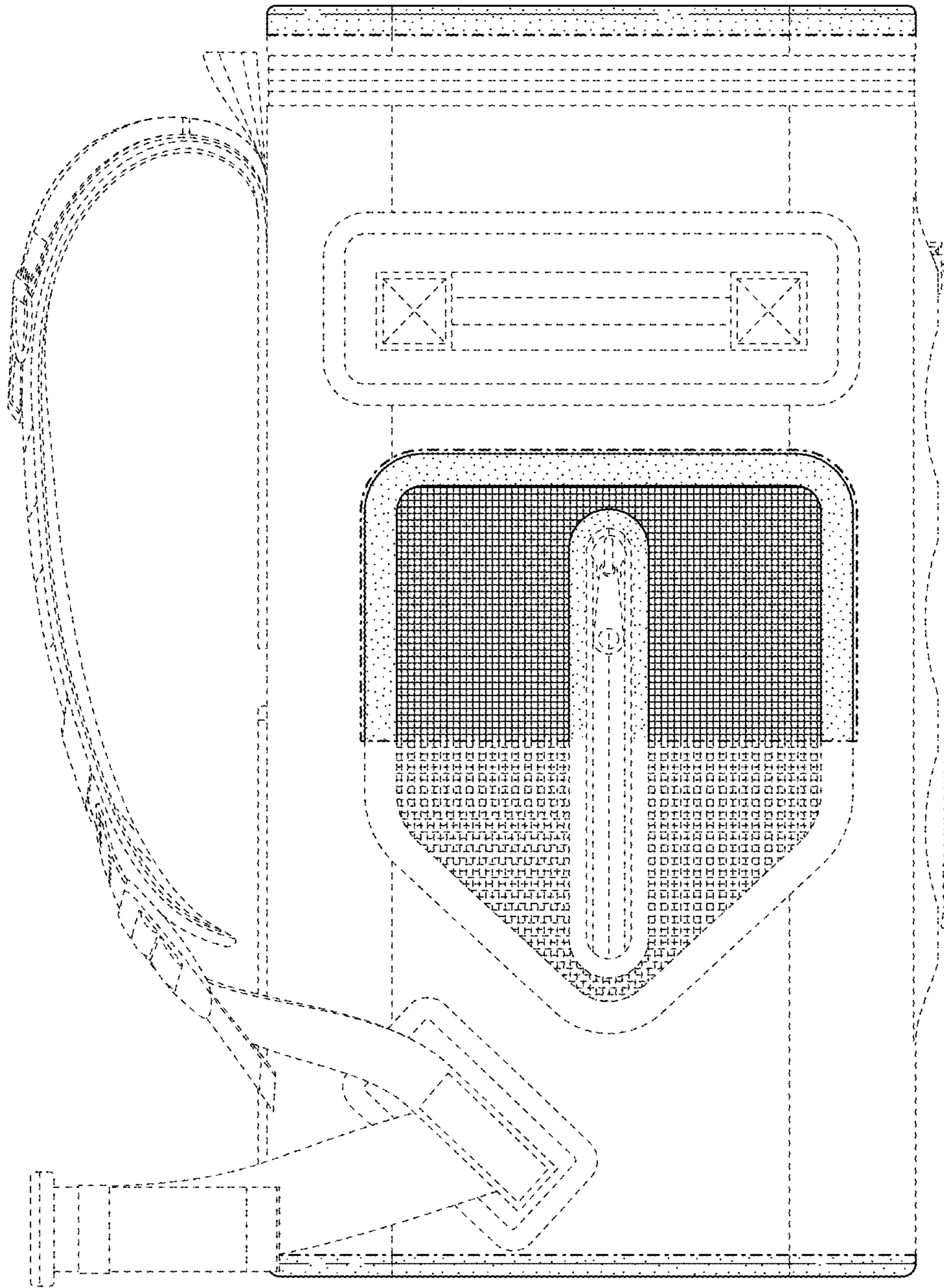

FIG. 4

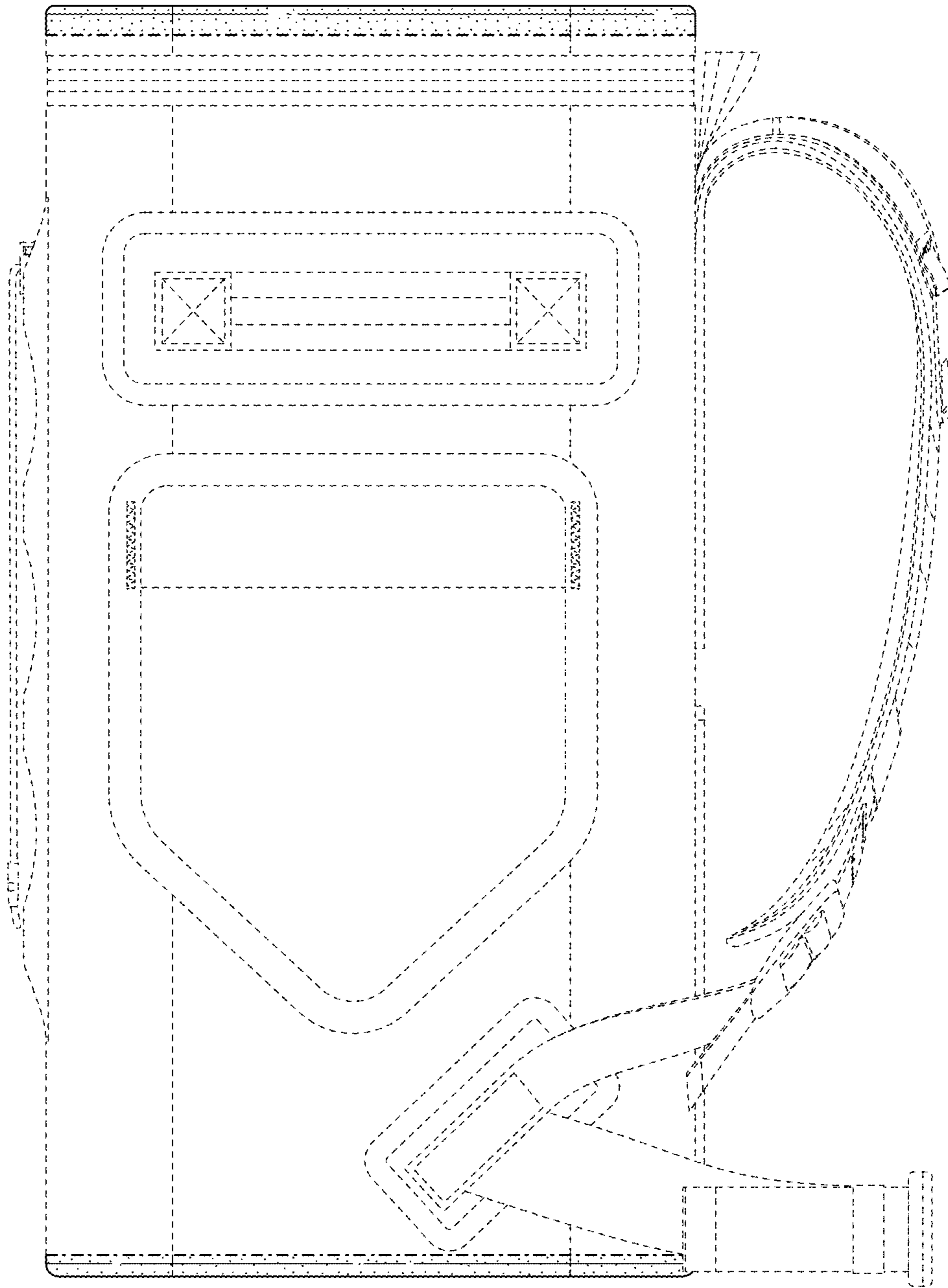

FIG. 5

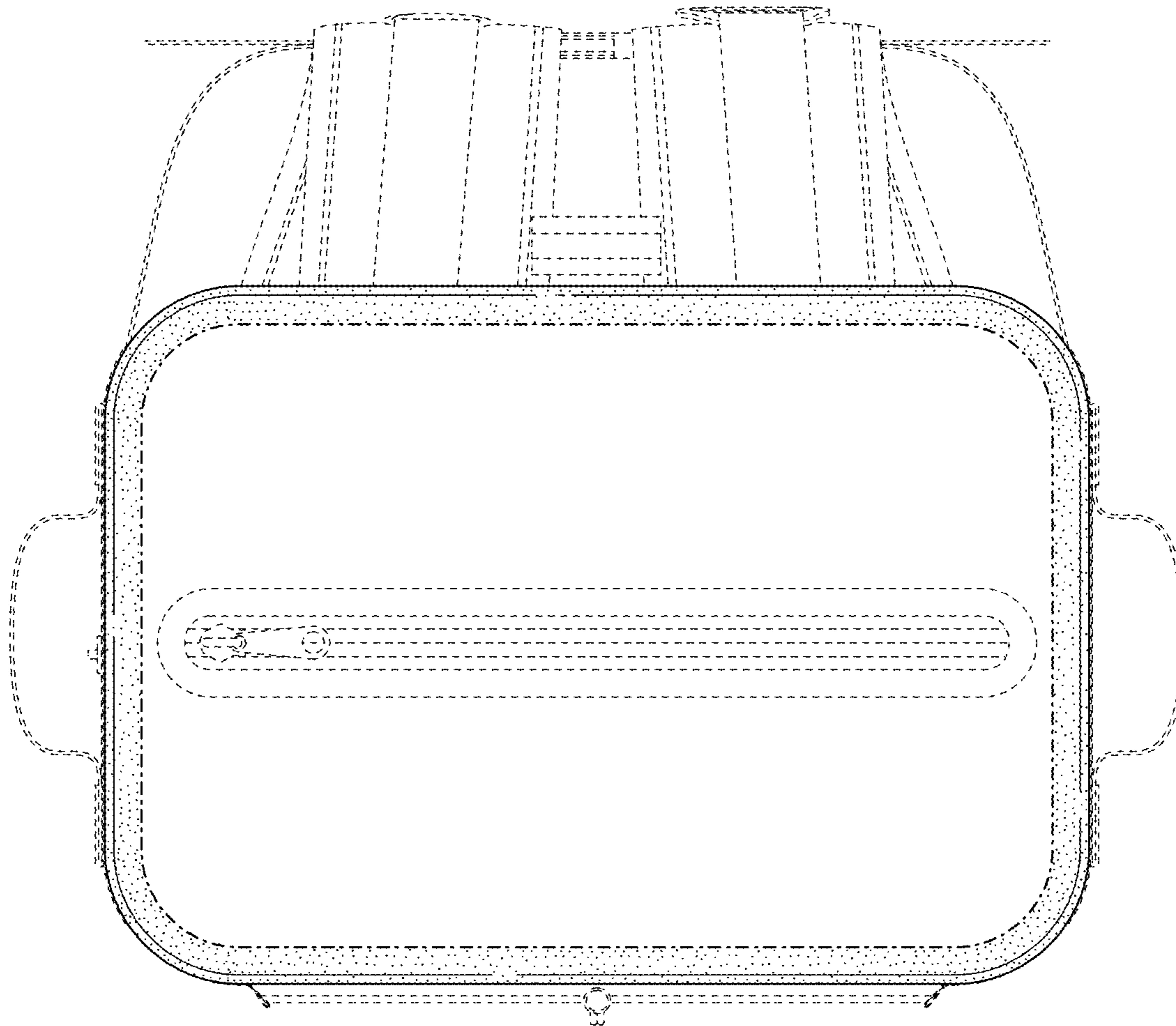

FIG. 6

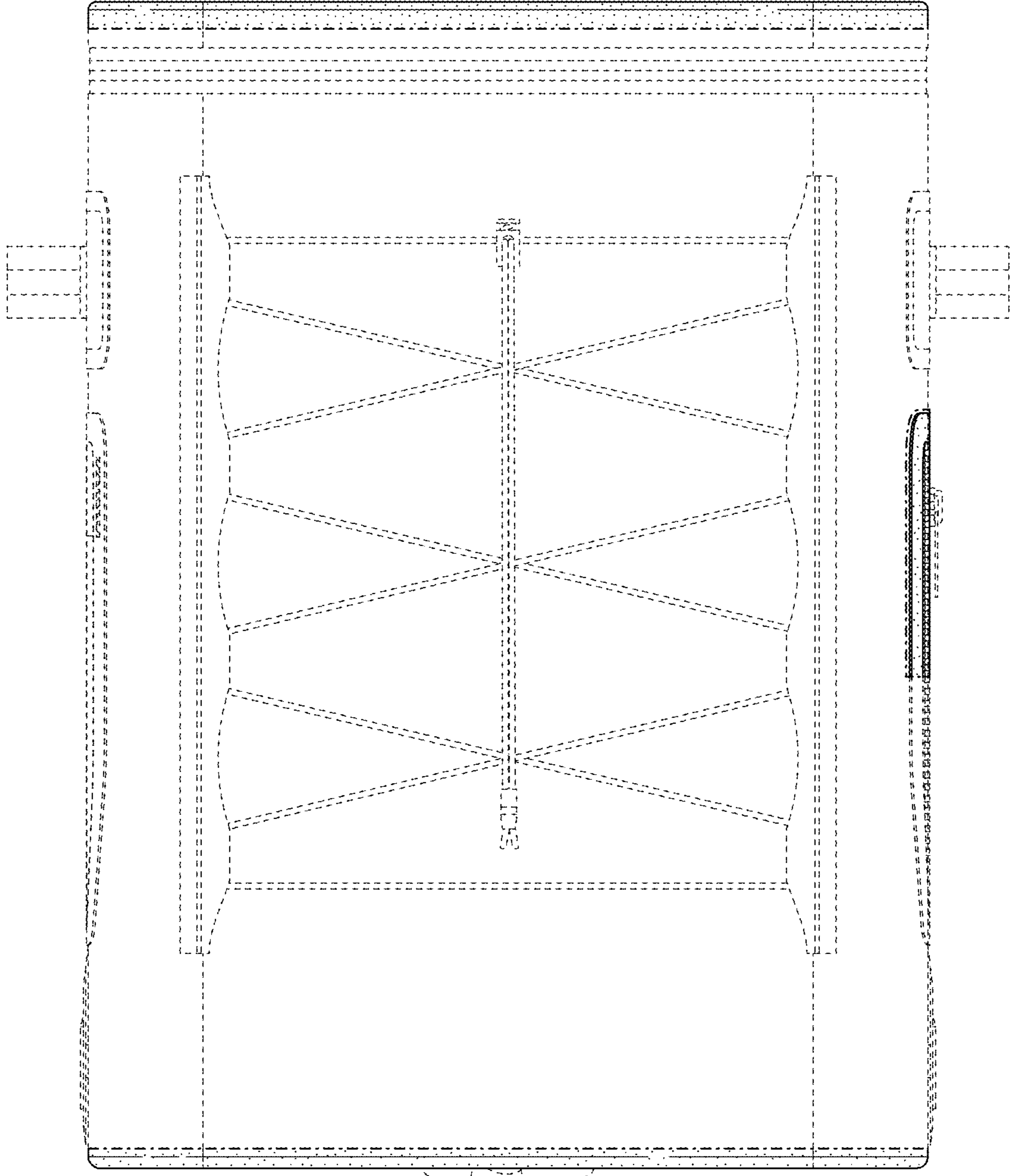

FIG. 7

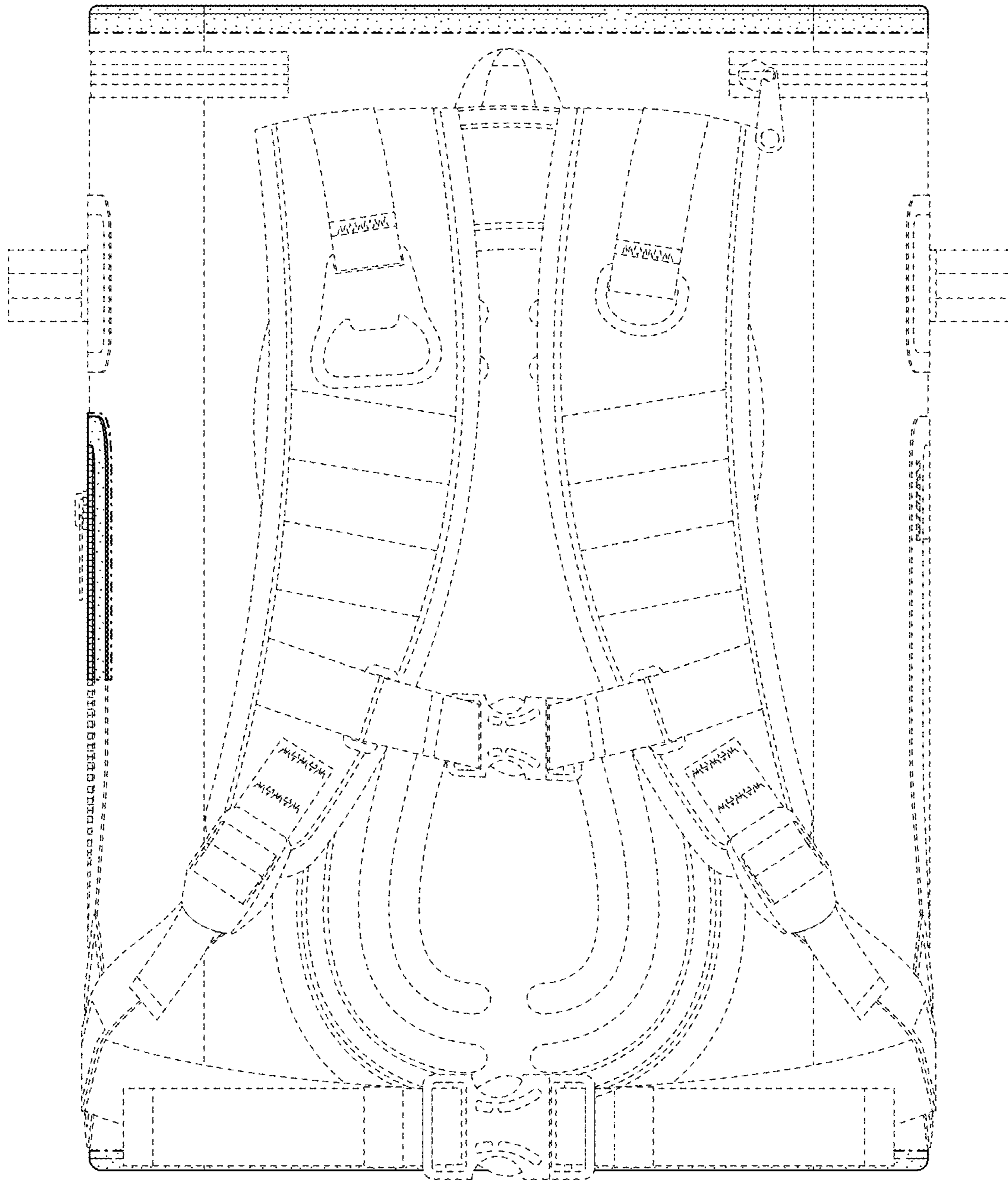

FIG. 8

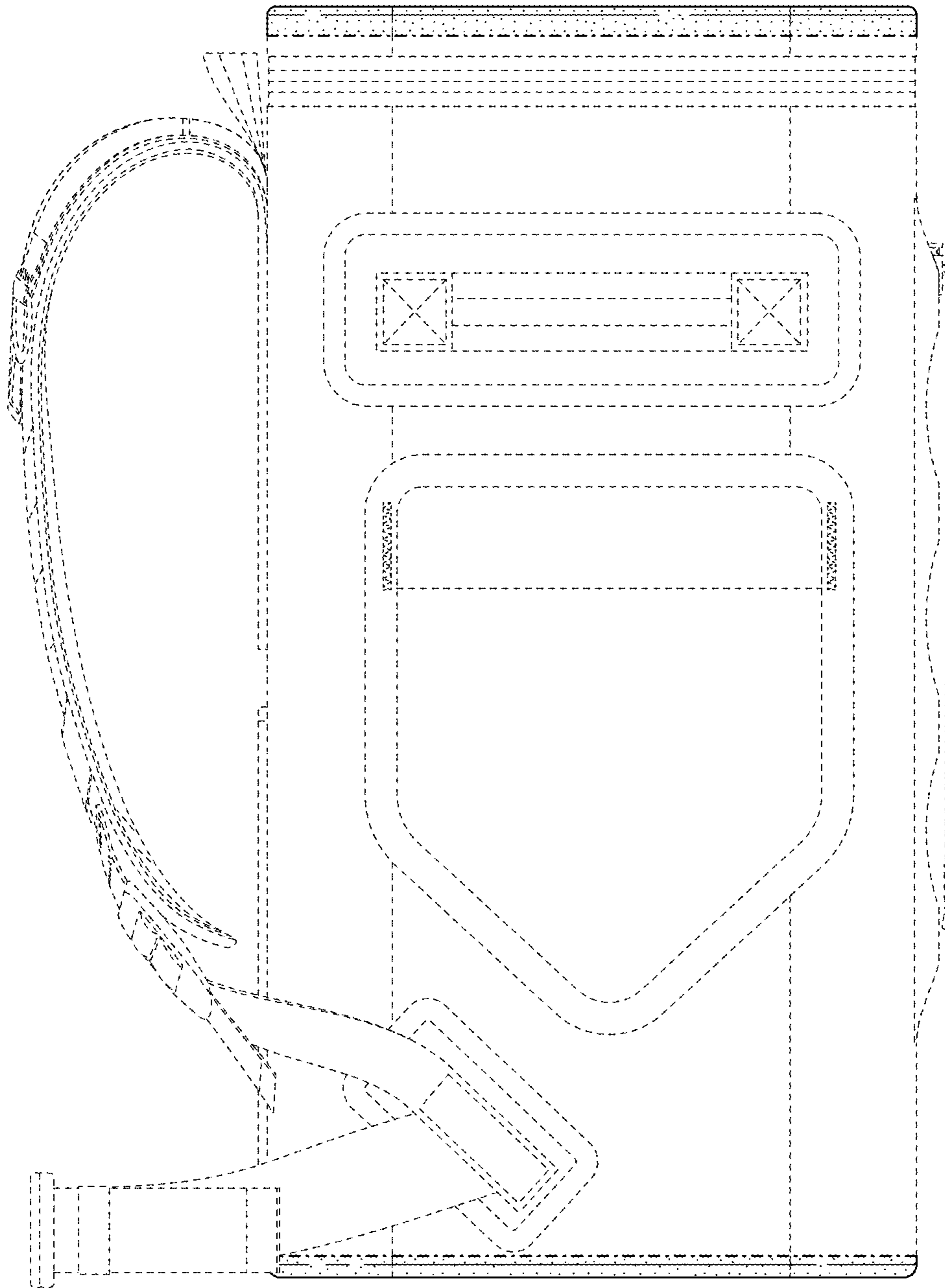

FIG. 9

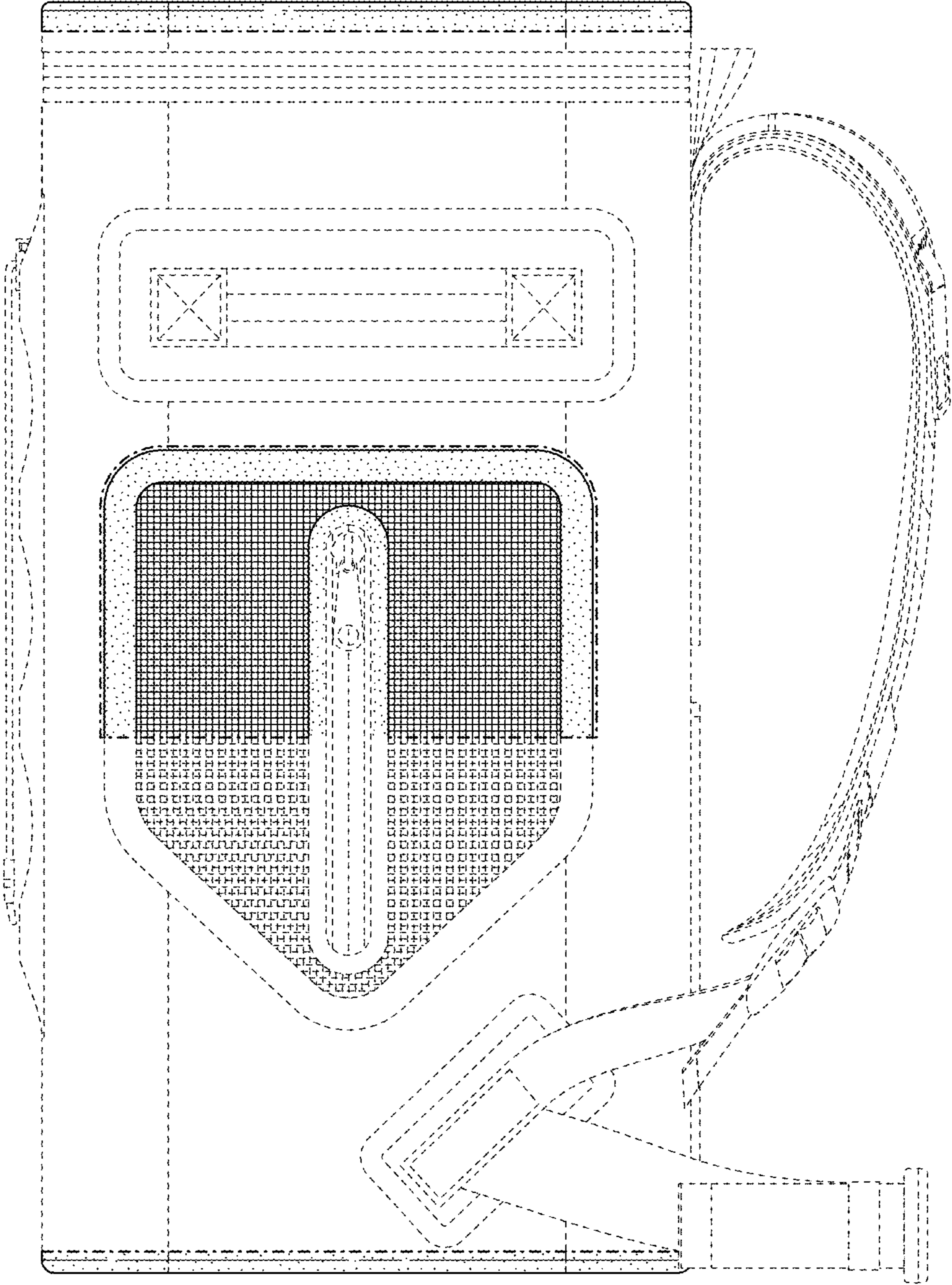

FIG. 10

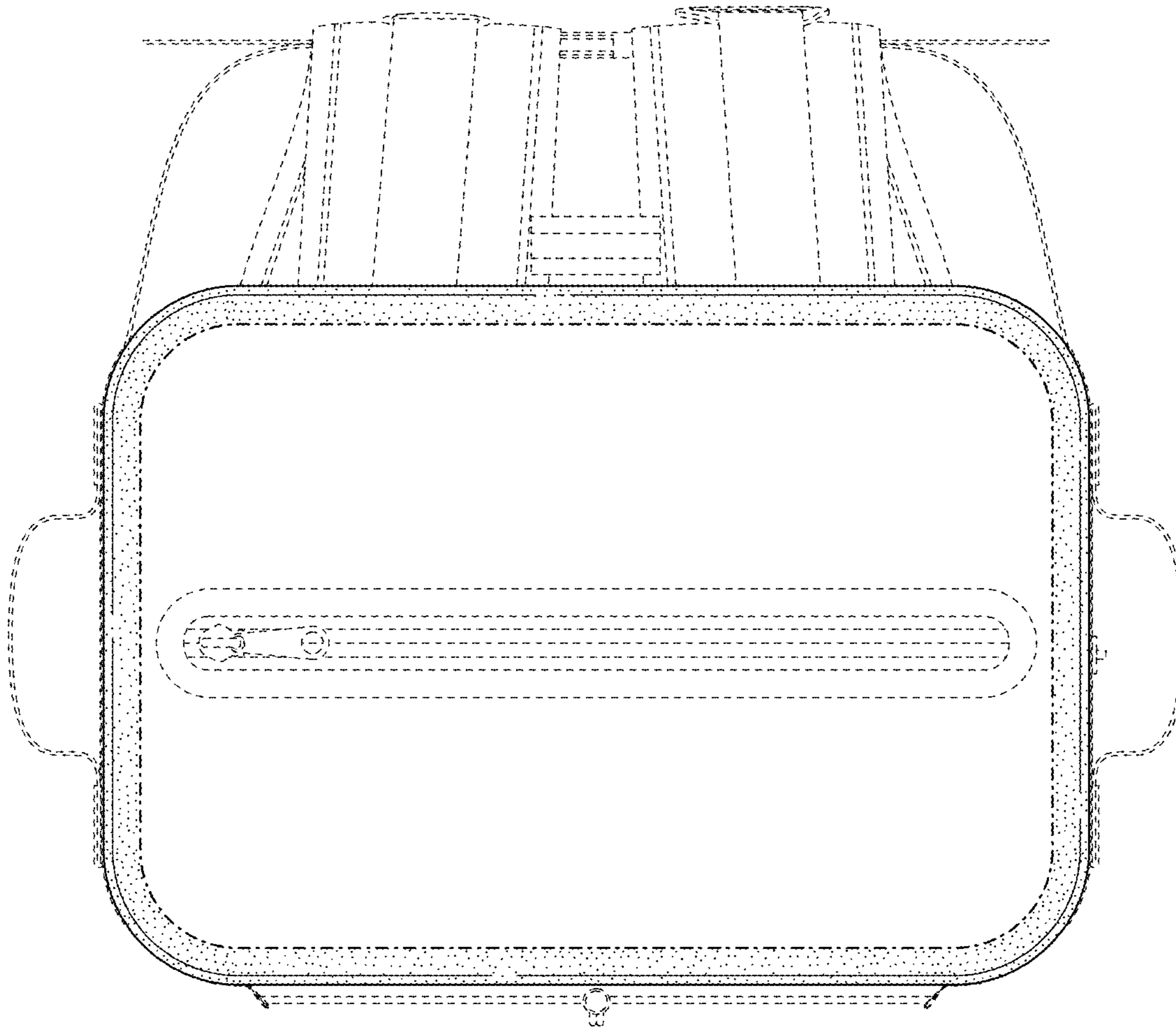

FIG. 11