



US00D959916S

(12) **United States Design Patent** (10) **Patent No.:** **US D959,916 S**
Koide (45) **Date of Patent:** **** Aug. 9, 2022**

(54) **WATER BOTTLE**
(71) Applicant: **KINTO Co., Ltd.**, Hikone (JP)
(72) Inventor: **Miki Koide**, Tokyo (JP)
(73) Assignee: **KINTO CO., LTD.**, Hikone (JP)
(**) Term: **15 Years**
(21) Appl. No.: **29/753,453**

D814,928 S * 4/2018 Seiders D9/443
D816,398 S * 5/2018 Fleischhut D7/392.1
D831,436 S * 10/2018 Seiders D7/608
D835,394 S * 12/2018 Rothbucher D3/10
D839,683 S * 2/2019 Wong D7/608
(Continued)

FOREIGN PATENT DOCUMENTS

CN 302540507 * 8/2013
CN 303449124 * 11/2015
(Continued)

OTHER PUBLICATIONS

Bindle [online] URL: <https://www.amazon.com/Bindle-Stainless-Integrated-Compartment-Eco-Friendly/dp/B07CHVW9SZ> (site visited: Nov. 26, 2021) (Year: 2018).*
(Continued)

Primary Examiner — Jae Liang
Assistant Examiner — Tia Ruth-Renee Polidori
(74) *Attorney, Agent, or Firm* — Stetina Brunda Garred and Brucker

(57) **CLAIM**

The ornamental design for a water bottle, as shown and described.

DESCRIPTION

FIG. 1 is a top perspective view of my new design for a water bottle;
FIG. 2 is a top plan view thereof;
FIG. 3 is a bottom plan view thereof;
FIG. 4 is a front elevation view thereof;
FIG. 5 is a back elevation view thereof;
FIG. 6 is a left side elevation view thereof; and,
FIG. 7 is a right side elevation view thereof.
The portions of the water bottle shown in broken lines in FIG. 3 form no part of the claimed design.

1 Claim, 3 Drawing Sheets

(56) **References Cited**

U.S. PATENT DOCUMENTS

D626,416 S * 11/2010 Cresswell D9/503
D627,227 S * 11/2010 Andis D9/503
D628,486 S * 12/2010 Lane D9/503
D633,338 S * 3/2011 Rosbach D7/511
D635,457 S * 4/2011 Lane D7/511
D675,100 S * 1/2013 Herbst D9/504
D702,506 S * 4/2014 Mettler D7/608
D708,954 S * 7/2014 Barnes D9/504
D712,255 S * 9/2014 Geis D9/436
9,505,527 B1 * 11/2016 Campbell A47G 19/2205
D782,881 S * 4/2017 Seiders D7/608

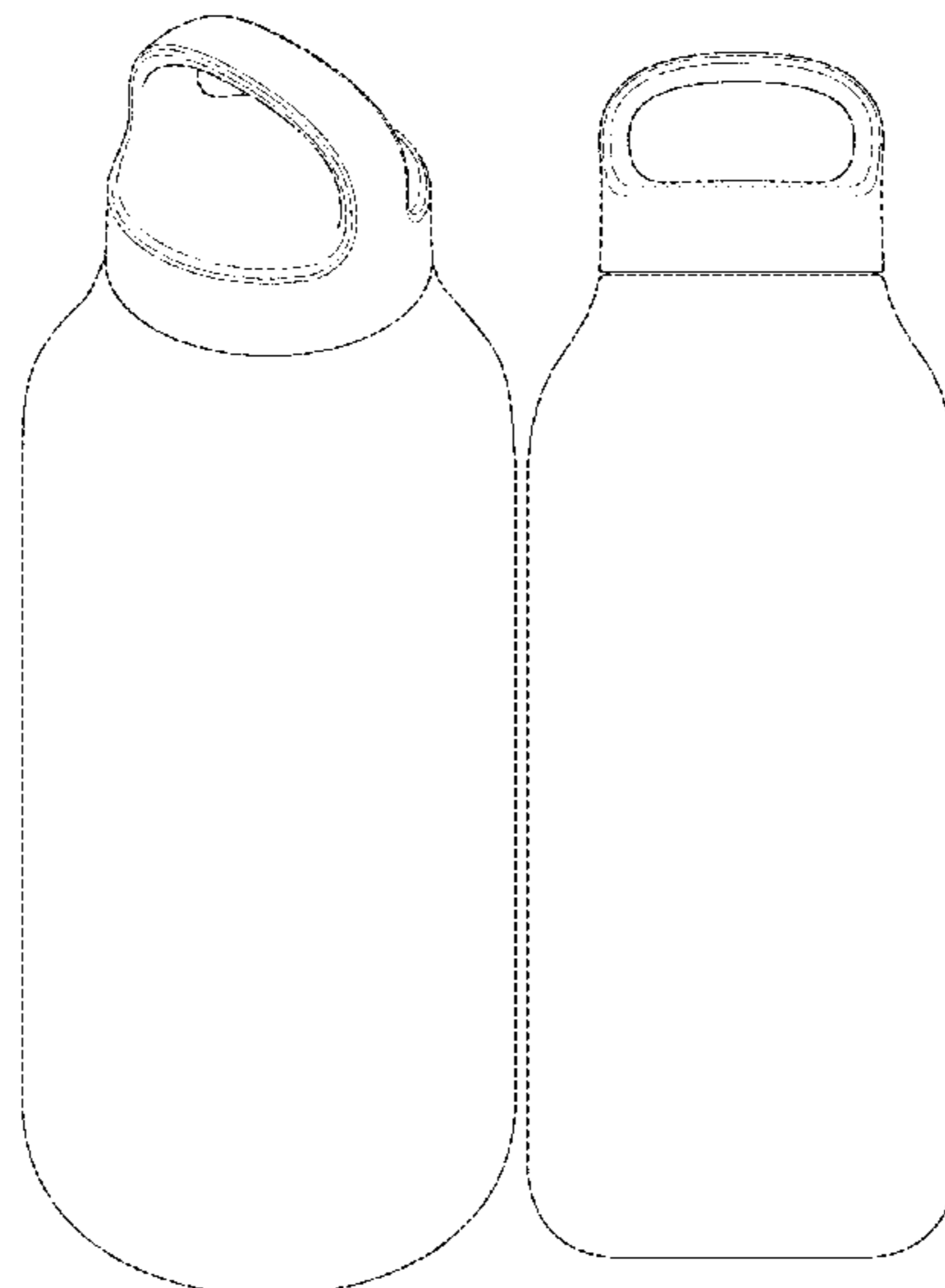

(56)

References Cited

U.S. PATENT DOCUMENTS

D842,027 S * 3/2019 Boroski D7/392.1
 D843,212 S * 3/2019 Seiders D9/443
 D856,757 S * 8/2019 Seiders D7/608
 D862,992 S * 10/2019 Wong D7/608
 D865,450 S * 11/2019 Jacobsen D7/511
 D878,874 S * 3/2020 Seiders D7/608
 D880,230 S * 4/2020 Jacobsen D7/396.2
 D897,158 S * 9/2020 Gilmore, III D7/510
 D899,859 S * 10/2020 Jacobsen D7/511
 D899,860 S * 10/2020 Jacobsen D7/511
 D901,976 S * 11/2020 Sibbert D7/511
 D917,225 S * 4/2021 Huang D7/392.1
 D919,377 S * 5/2021 Seiders D7/608
 D922,152 S * 6/2021 Seiders D7/608
 D923,406 S * 6/2021 Tsigounis D7/507
 D923,409 S * 6/2021 Backs D7/511
 D926,579 S * 8/2021 Sanders D9/500
 D930,437 S * 9/2021 Paparao D7/510
 D931,060 S * 9/2021 Volkoff D7/608
 D931,687 S * 9/2021 Volkoff D7/608
 D943,357 S * 2/2022 Seiders D7/608
 D945,215 S * 3/2022 Lowette D7/396.2
 D945,219 S * 3/2022 Petersson D7/511
 D945,220 S * 3/2022 Petersson D7/511
 D946,347 S * 3/2022 Zhang D7/392.1
 D948,286 S * 4/2022 Lin D7/533
 D950,316 S * 5/2022 Wang D7/511
 D951,023 S * 5/2022 Bodum D7/510
 2013/0153591 A1 * 6/2013 Grimes A01K 89/08
 2016/0003615 A1 * 1/2016 Biswas G16H 20/10
 2017/0119212 A1 * 5/2017 Petrillo A47J 41/02

2018/0009576 A1 * 1/2018 Sullivan B65D 51/18
 2019/0375548 A1 * 12/2019 Campbell B65D 81/3876
 2020/0107667 A1 * 4/2020 Ayres A47J 31/005
 2020/0216212 A1 * 7/2020 Spaccarelli A47G 19/00
 2021/0086944 A1 * 3/2021 Hammond B65D 21/0233
 2021/0355000 A1 * 11/2021 Guduru B01D 29/11

FOREIGN PATENT DOCUMENTS

CN 305832837 * 6/2020
 CN 306954138 * 11/2021
 CN 307105175 * 2/2022
 JP D1646291 * 11/2019
 JP D1673104 * 11/2020
 KR 301101682.0000 * 3/2021
 KR 301127295.0000 * 9/2021

OTHER PUBLICATIONS

Kinto [online] URL: <https://www.amazon.com/KINTO-DAY-OFF-TUMBLER-500ml/dp/B07G4YXMNK> (site visited: Nov. 26, 2021) (Year: 2018).*

Kinto [online] URL: <https://www.amazon.com/Water-Bottle-Kinto-500ml-Smoke/dp/B08HV788P9> (site visited: Nov. 26, 2021) (Year: 2020).*

Bink [online] URL: <https://binkmade.com/products/mama-bottle> (site visited: May 16, 2022) (Year: 2020).*

Ikea [online] URL: <https://www.ikea.com/us/en/p/ikea-365-water-bottle-dark-gray-20480013/> (site visited: May 16, 2022) (Year: 2020).*

* cited by examiner

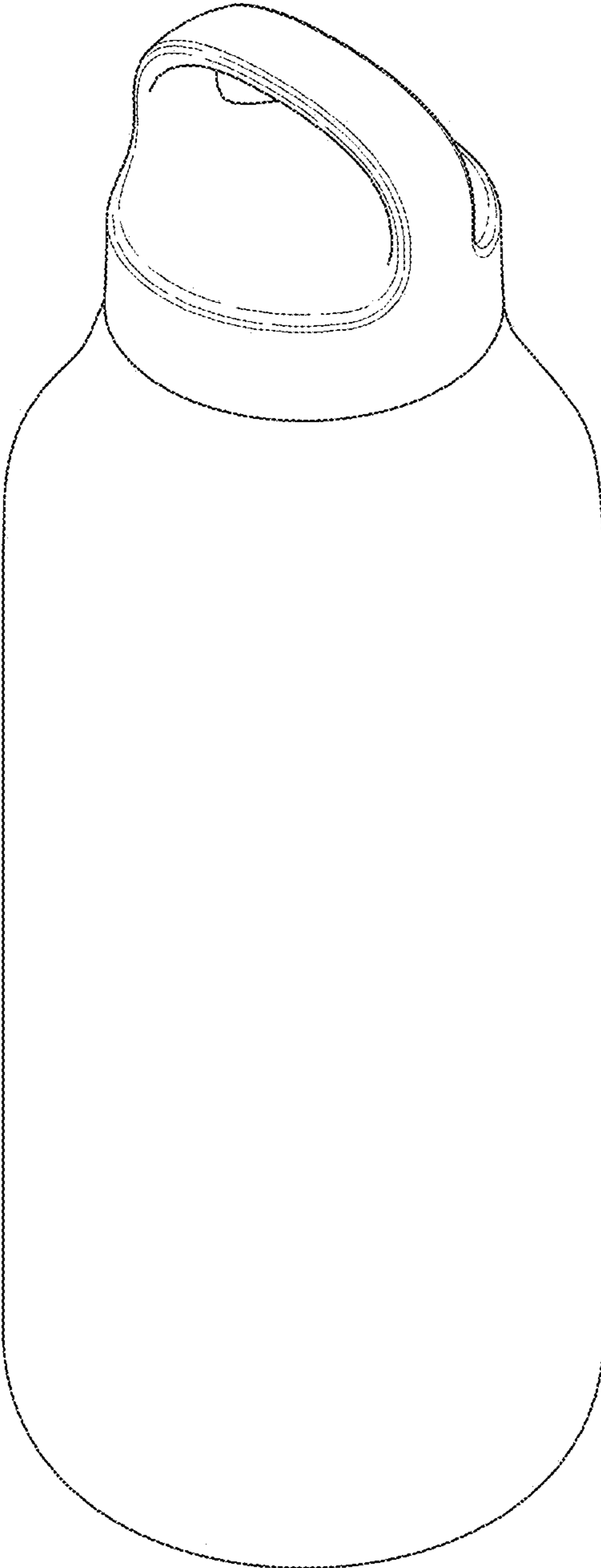

FIG. 1

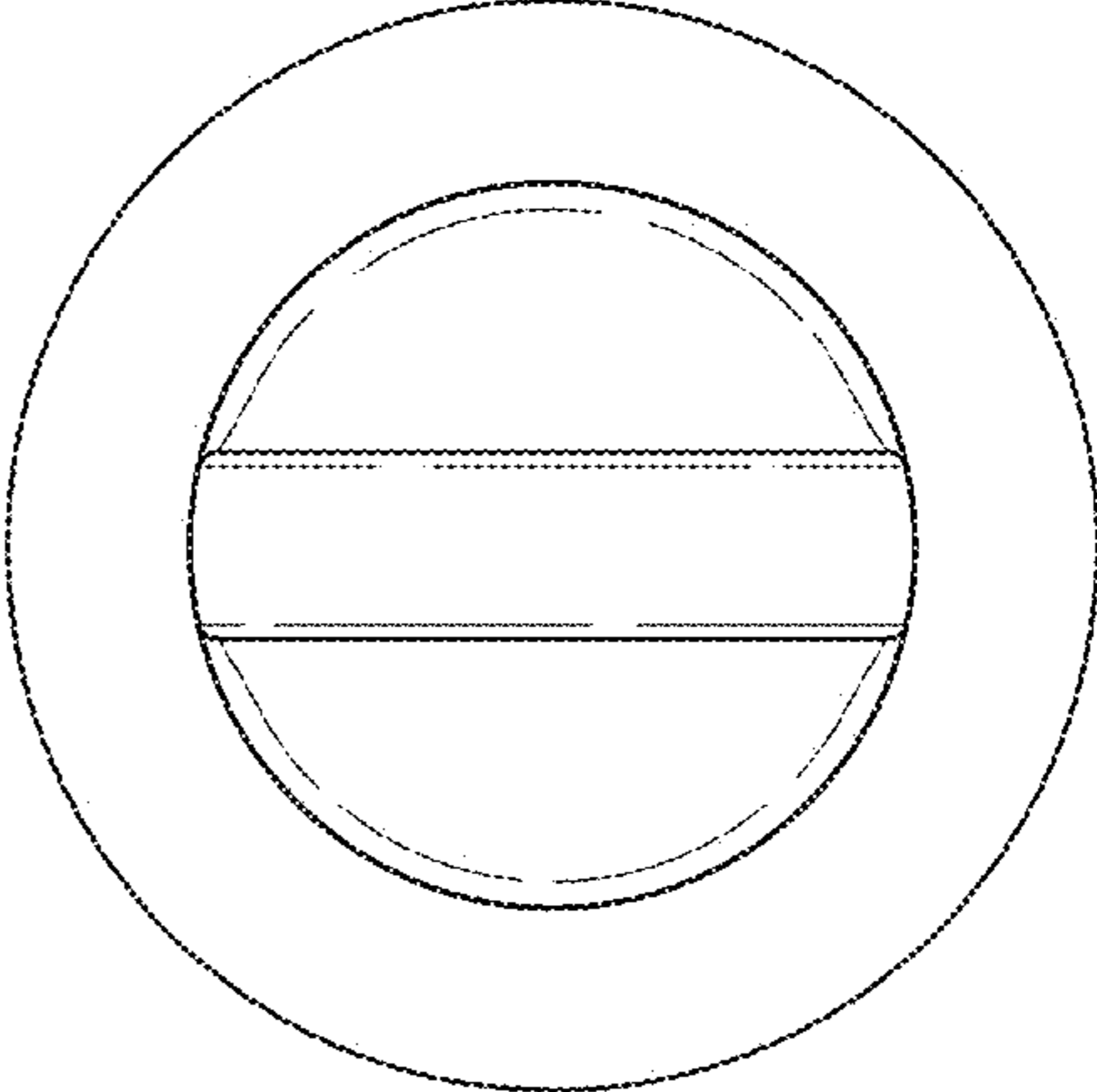

FIG. 2

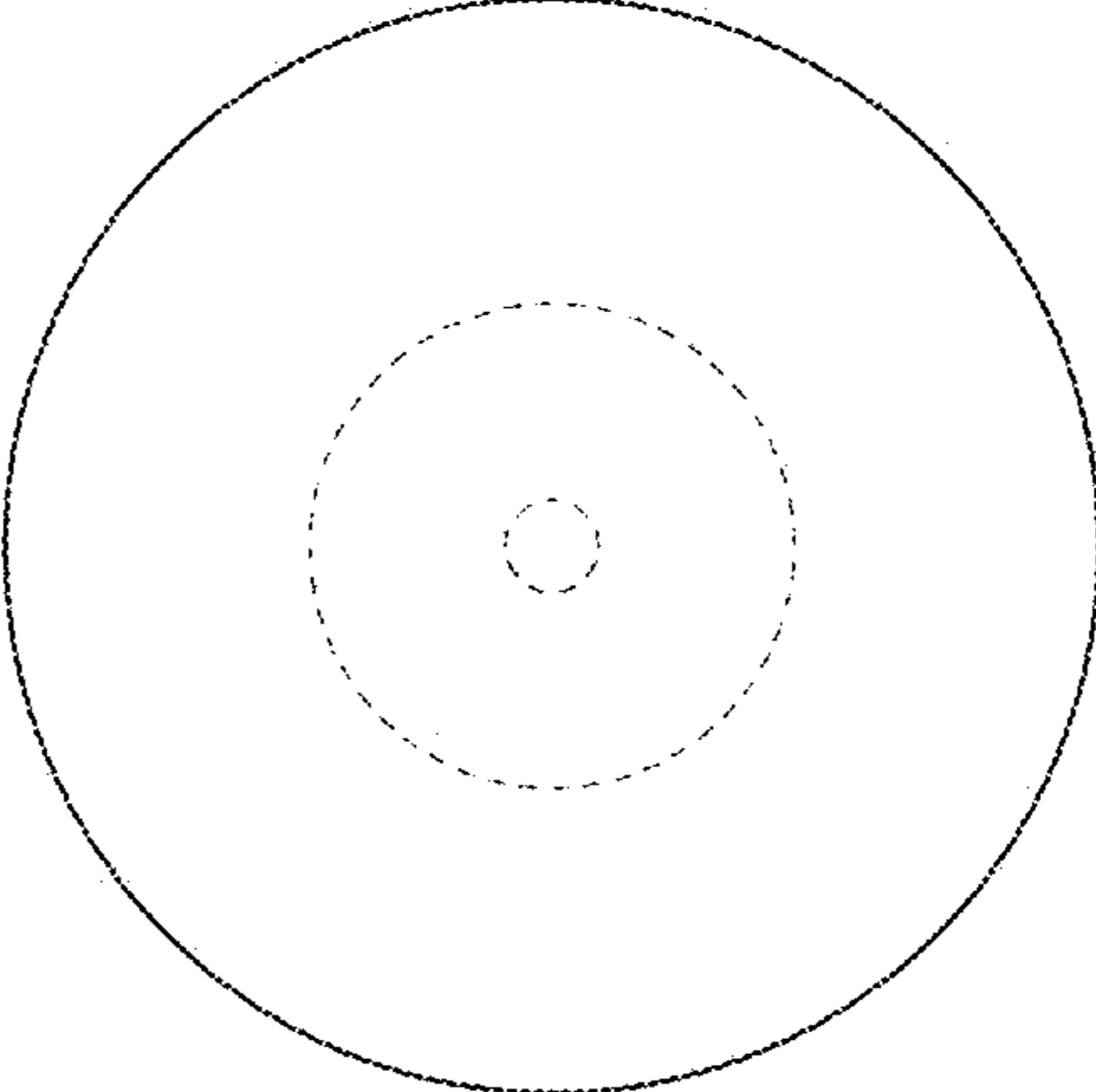

FIG. 3

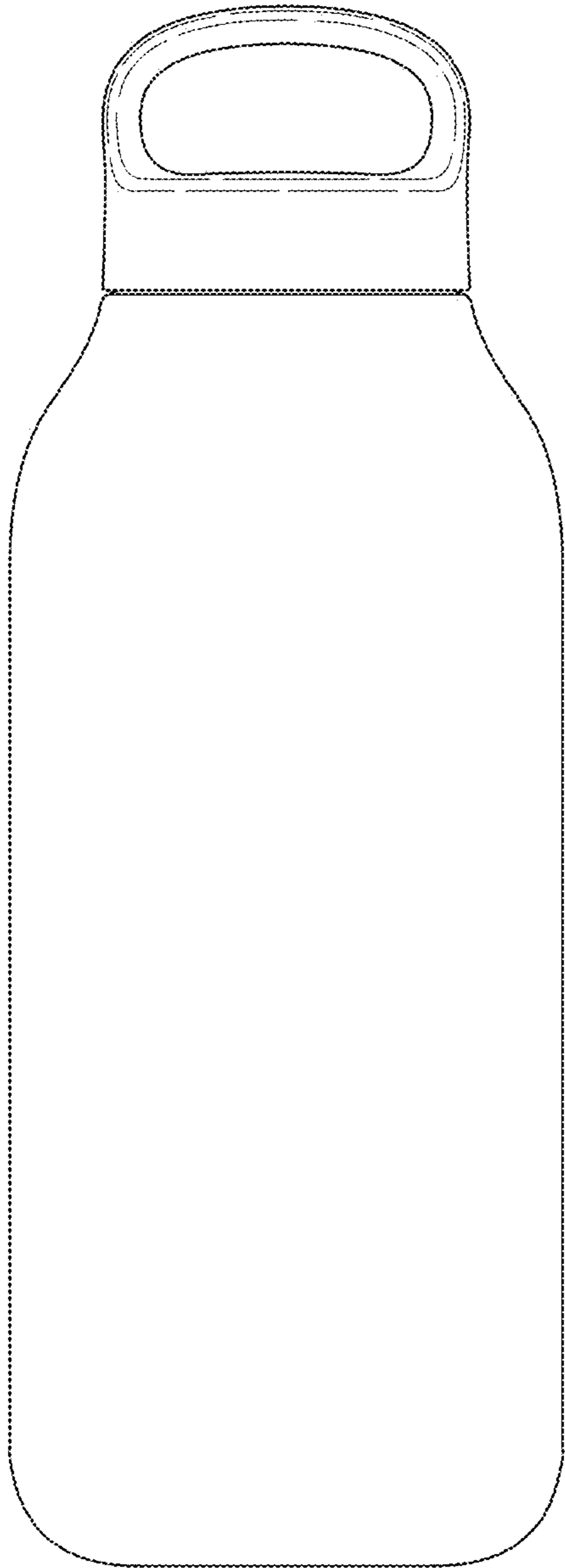

FIG. 4

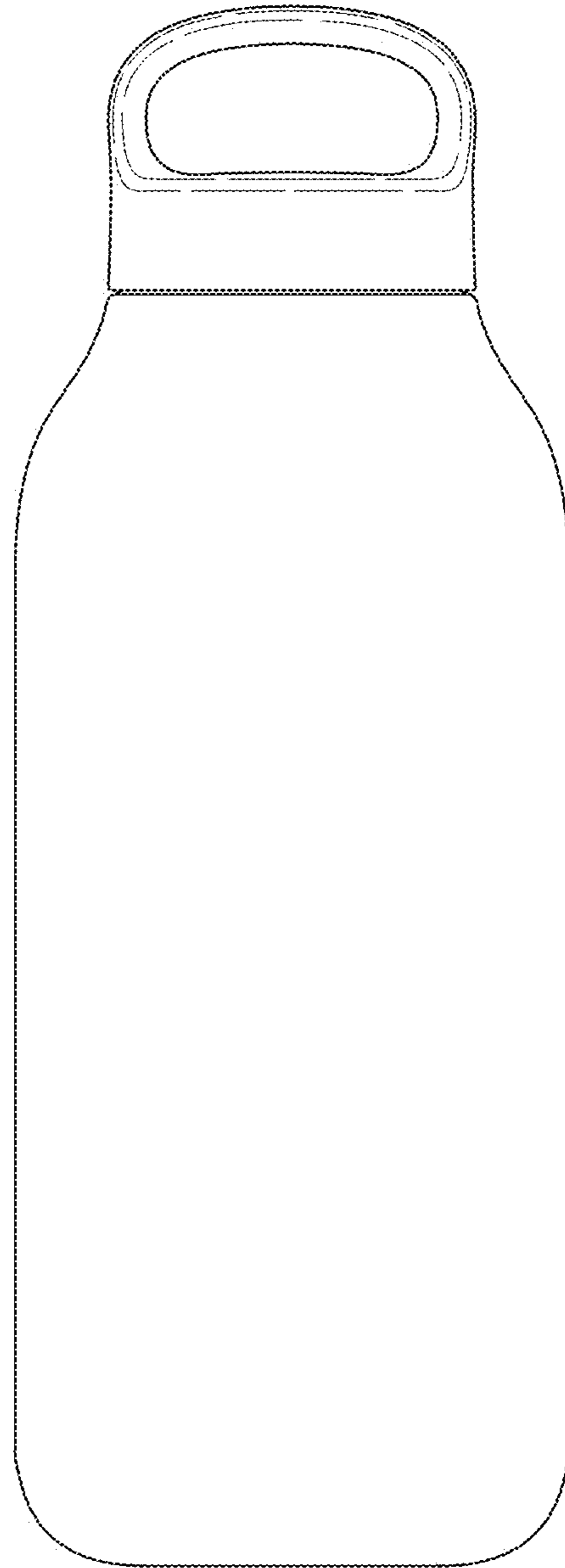

FIG. 5

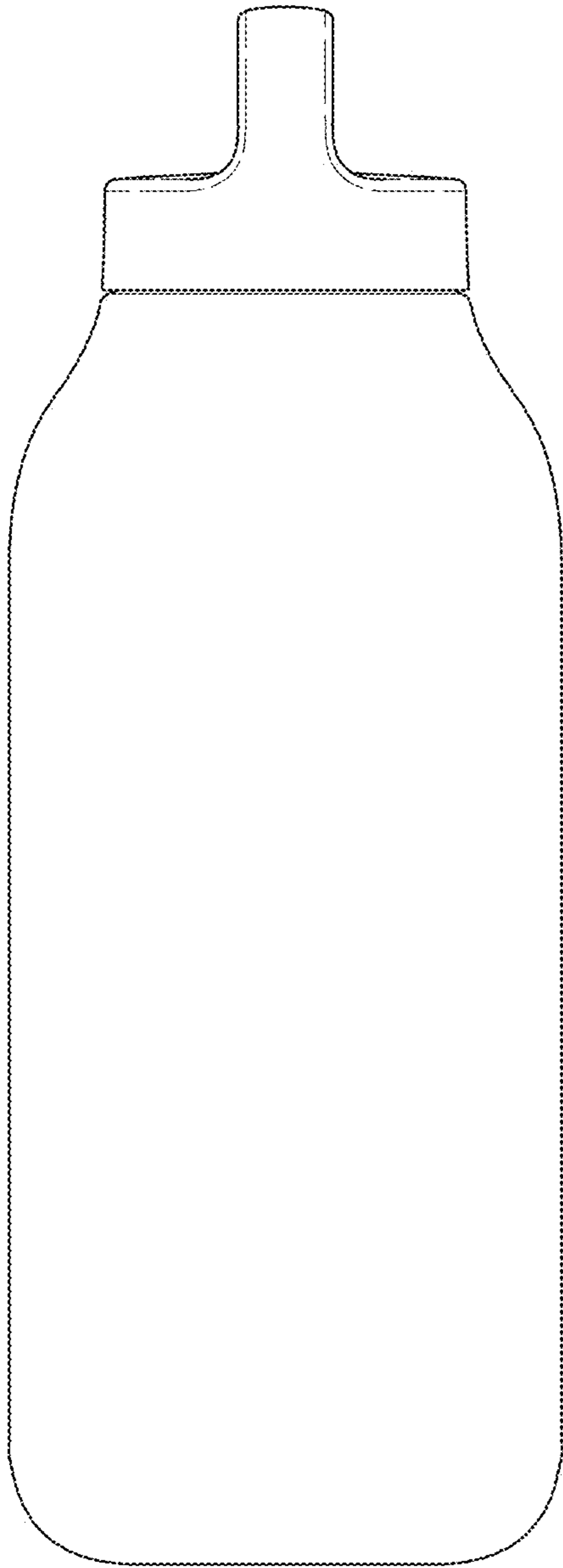

FIG. 6

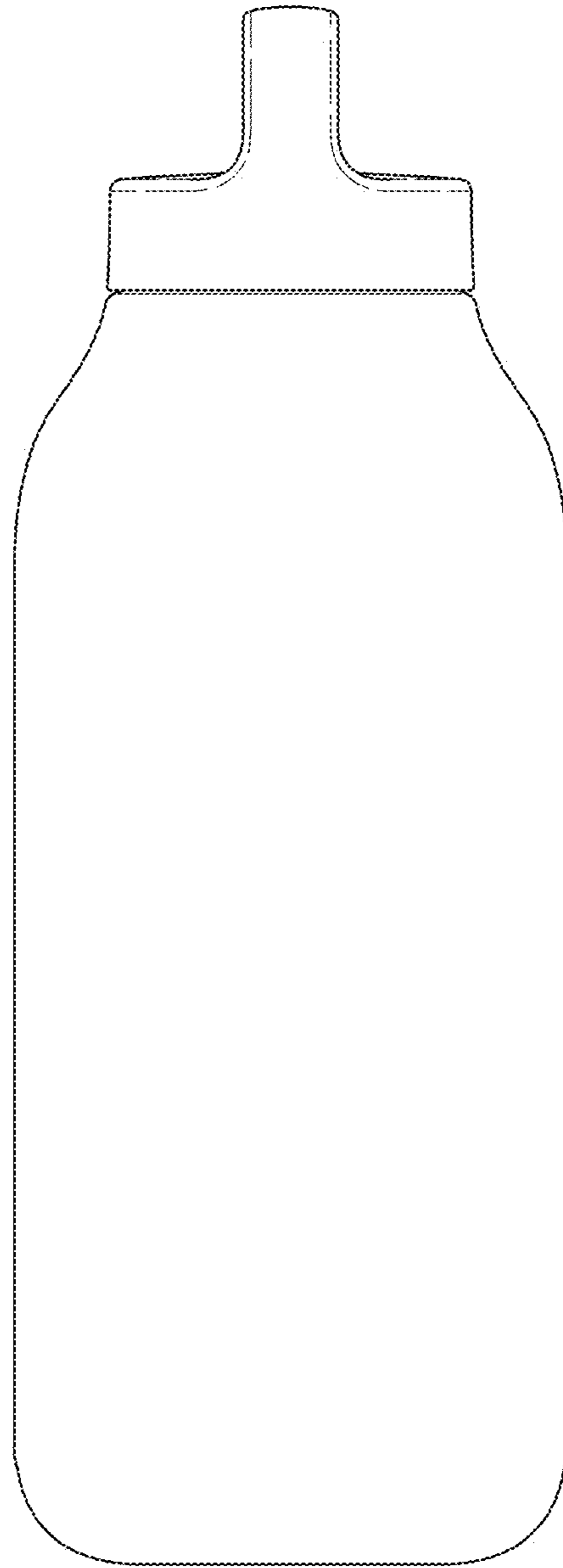

FIG. 7