



US00D959889S

(12) **United States Design Patent** (10) **Patent No.:** **US D959,889 S**  
**Mycroft** (45) **Date of Patent:** **\*\* Aug. 9, 2022**

(54) **BEVERAGE DISPENSER**  
(71) Applicant: **The Coca-Cola Company**, Atlanta, GA (US)

D832,021 S \* 10/2018 Yoon ..... D7/307  
D863,439 S \* 10/2019 Mycroft ..... D20/1  
D873,071 S \* 1/2020 Broen ..... D7/307  
D876,147 S \* 2/2020 Rubin ..... D7/307

(Continued)

(72) Inventor: **Damian James Reec Mycroft**, Decatur, GA (US)

**FOREIGN PATENT DOCUMENTS**

(73) Assignee: **The Coca-Cola Company**, Atlanta, GA (US)

CN 301508835 \* 4/2011  
CN 302722453 \* 1/2014

(Continued)

(\*\*) Term: **15 Years**

**OTHER PUBLICATIONS**

(21) Appl. No.: **29/738,846**

The Coca-Cola Company, "Freestyle 8000/9000 Cleaning," Jan. 25, 2016, p. 1. (Year: 2016).\*

(22) Filed: **Jun. 19, 2020**

(Continued)

(51) **LOC (13) Cl.** ..... **31-00**

(52) **U.S. Cl.** ..... **D7/306**  
USPC .....

(58) **Field of Classification Search**  
USPC ..... D7/306-313; D15/80, 82; D20/1; D23/207

CPC ..... A47J 31/0615; A47J 31/32; A47J 31/369; A47J 31/4482; A47J 31/46; A47J 31/467; B67D 1/0021

See application file for complete search history.

*Primary Examiner* — Joseph Kukella  
*Assistant Examiner* — Arva P Adams  
(74) *Attorney, Agent, or Firm* — Meunier Carlin & Curfman LLC

(57) **CLAIM**

I claim the ornamental design for a beverage dispenser, as shown and described.

**DESCRIPTION**

(56) **References Cited**

**U.S. PATENT DOCUMENTS**

D156,279 S \* 11/1949 Rasmusson ..... D7/311  
D176,460 S \* 12/1955 Hagman ..... D23/207  
D250,536 S \* 12/1978 Bourke ..... D7/308  
D265,203 S \* 6/1982 Lents ..... D15/80  
D347,347 S \* 5/1994 Erdman ..... D7/308  
D597,107 S \* 7/2009 Ohtake ..... D15/80  
D626,776 S \* 11/2010 Voron ..... D7/307  
D627,187 S \* 11/2010 Voron et al.  
D644,712 S \* 9/2011 Seo ..... D7/307  
D758,119 S \* 6/2016 Sanchez ..... D7/307  
D795,629 S \* 8/2017 Ullman ..... D7/311  
D813,346 S \* 3/2018 Lee ..... D23/207

FIG. 1 is a first perspective view of a beverage dispenser, showing a first embodiment in accordance with our new design;

FIG. 2 is a second perspective view thereof

FIG. 3 is a front elevational view thereof;

FIG. 4 is a back elevational view thereof;

FIG. 5 is a first side elevational view thereof;

FIG. 6 is a second side elevational view thereof; and,

FIG. 7 is a top view thereof.

The even-length broken lines showing the remainder of the beverage dispenser are for environmental purposes only and form no part of the claimed design.

**1 Claim, 7 Drawing Sheets**

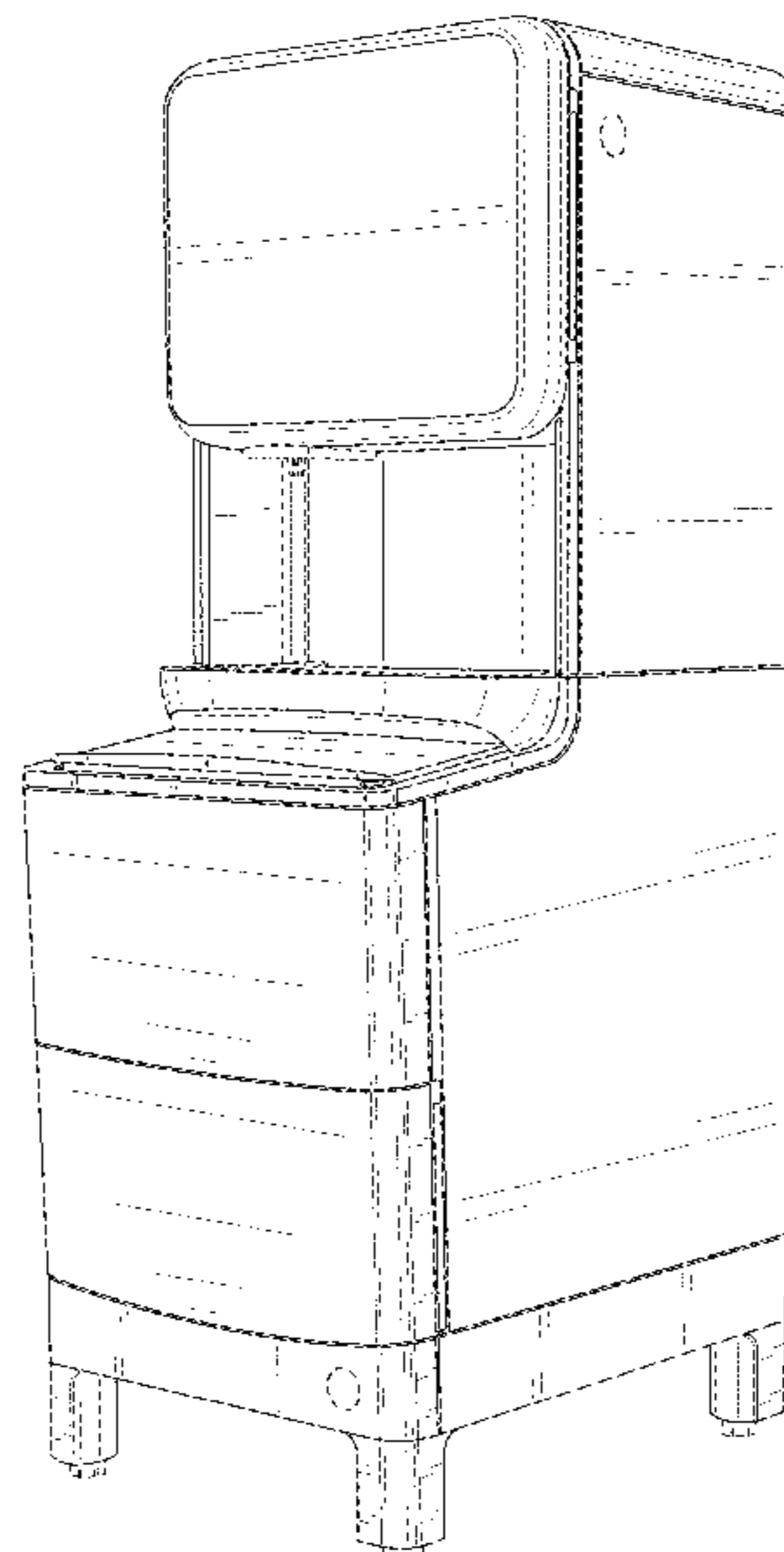

(56)

**References Cited**

U.S. PATENT DOCUMENTS

D886,522 S \* 6/2020 Lim ..... D7/307

FOREIGN PATENT DOCUMENTS

CN 305512498 \* 12/2019  
CN 305614322 \* 2/2020

OTHER PUBLICATIONS

Folett LLC, "Symphony Plus ice and water dispenser," Dec. 11, 2019, Folette, pp. 1-2. (Year: 2019).\*

Good Design, "Coca-Cola Freestyle 8100 | 2021," 2021, [www.good-designawards.com/award-details.html?award=41813](http://www.good-designawards.com/award-details.html?award=41813) (Year: 2021).\*

\* cited by examiner

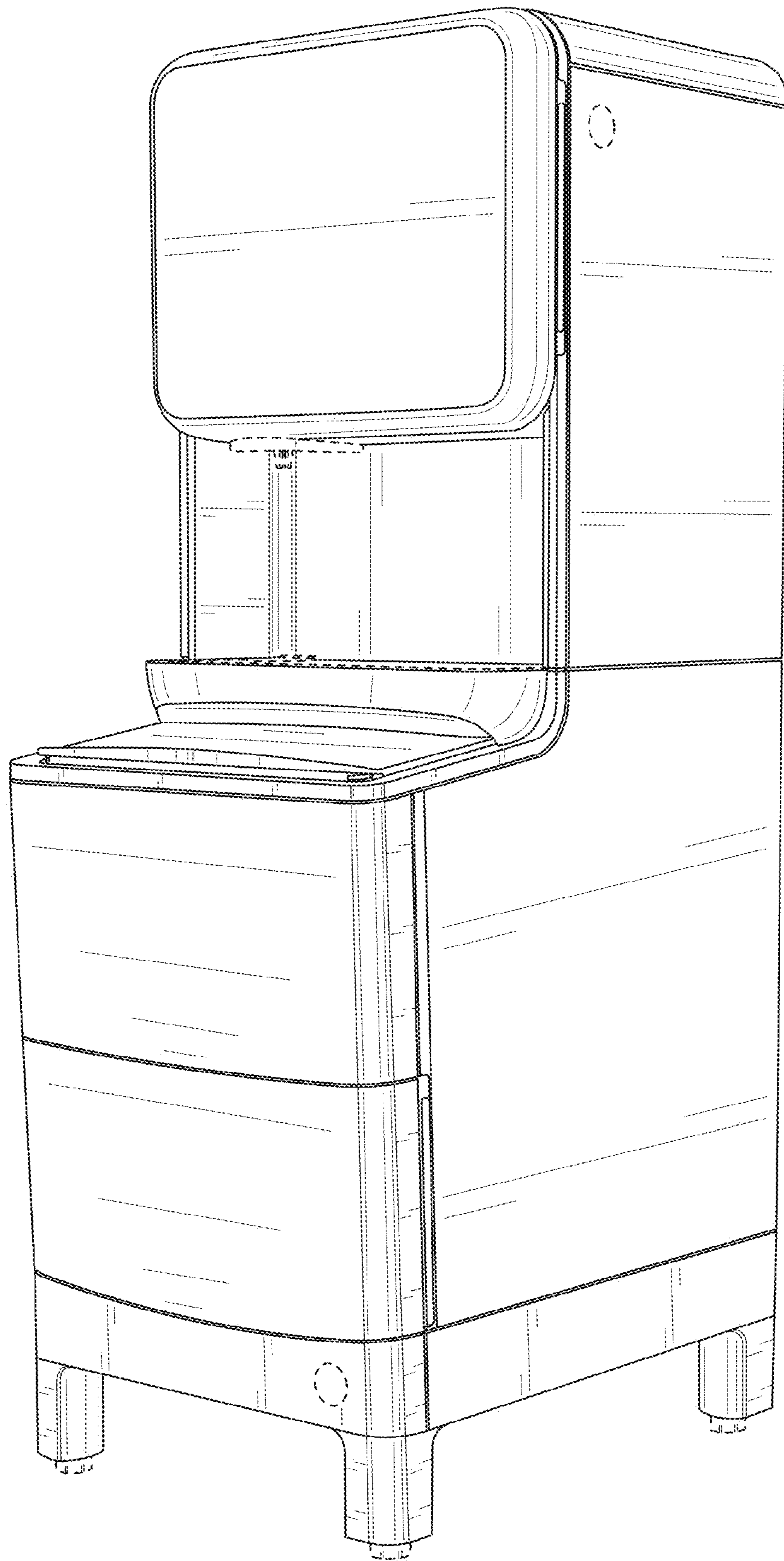

FIG. 1

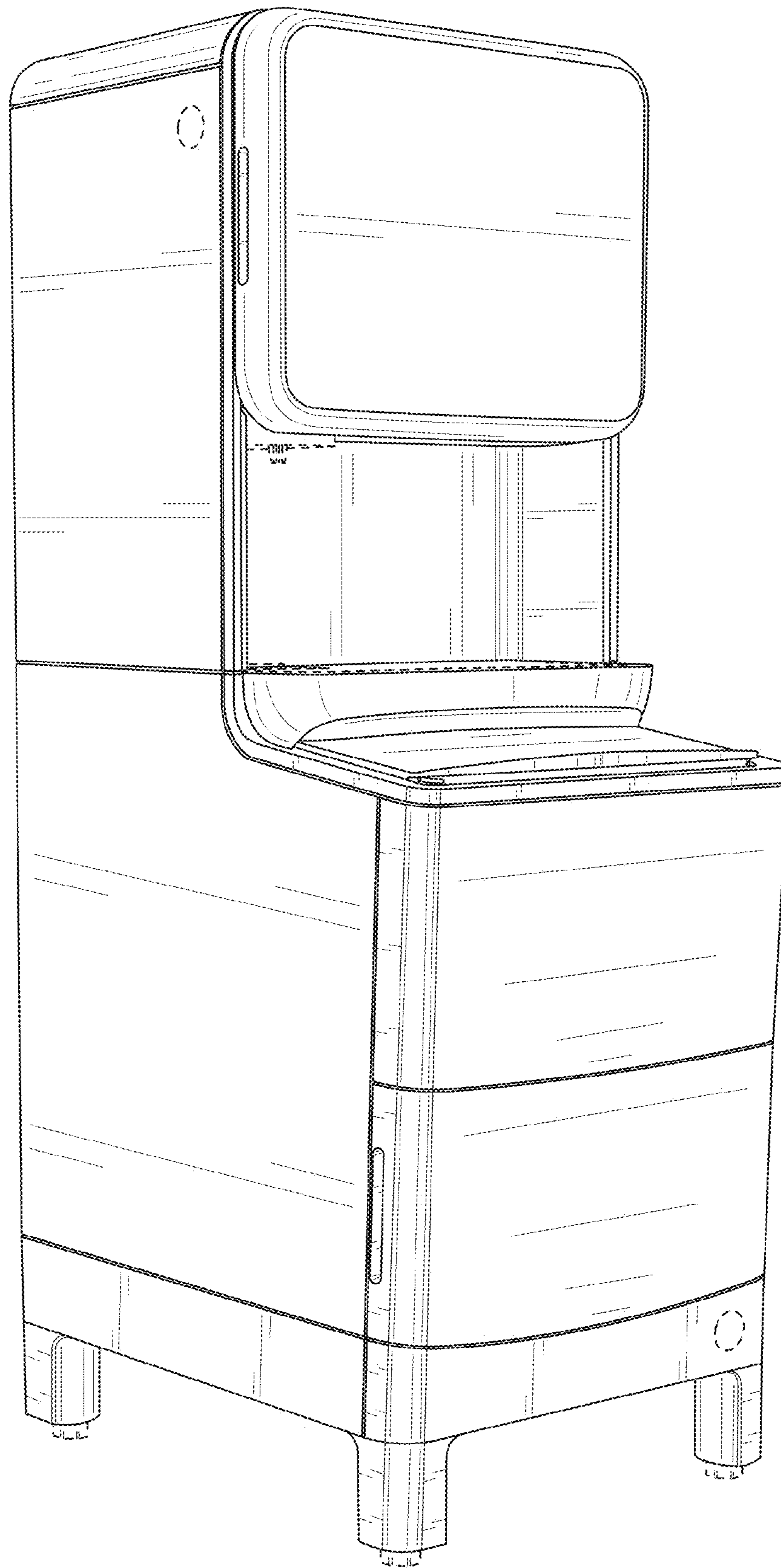

FIG. 2



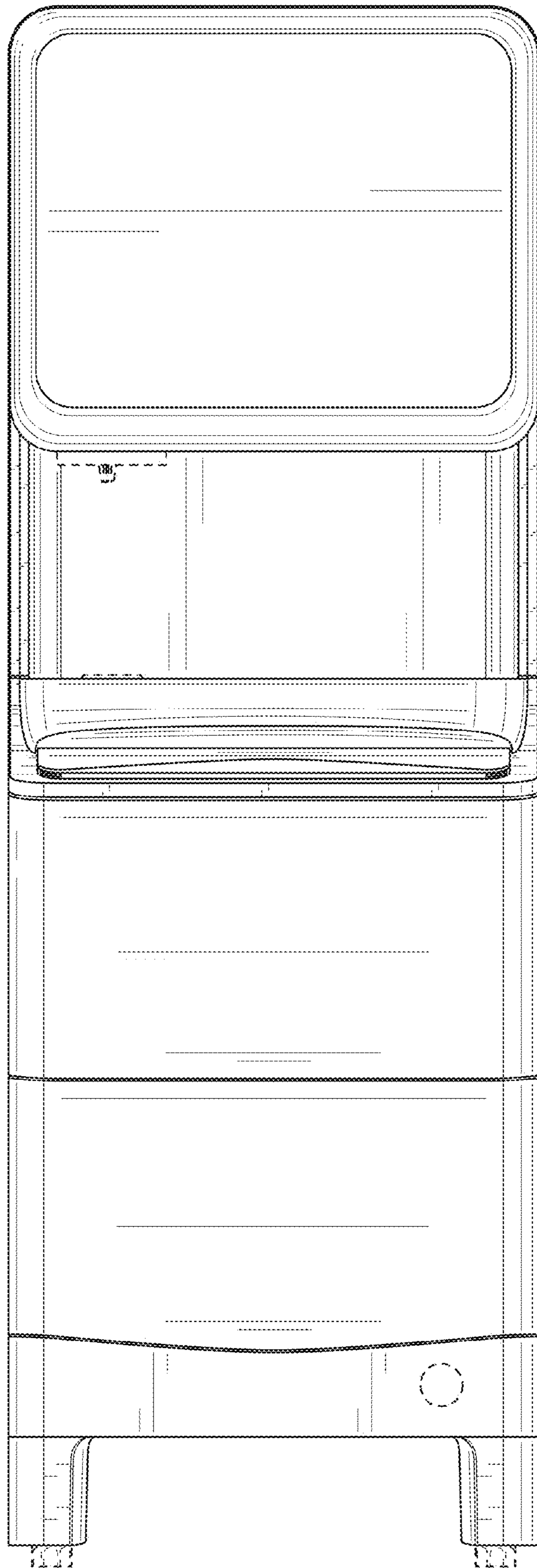

FIG. 3

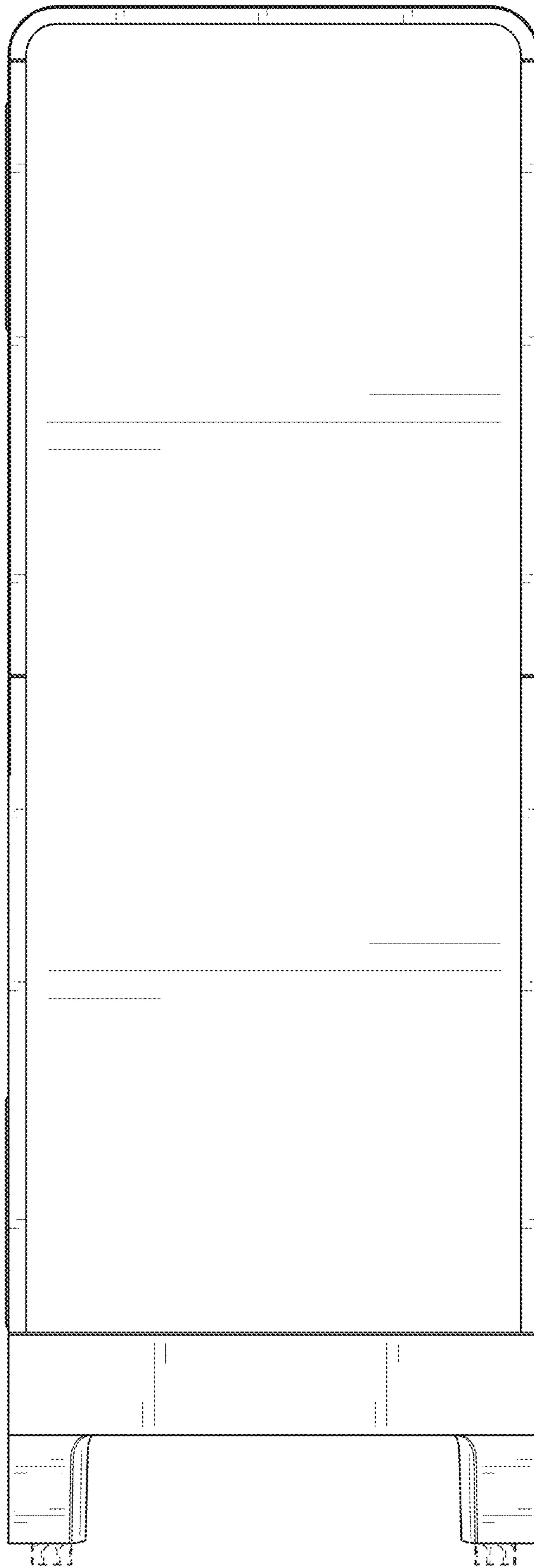

FIG. 4

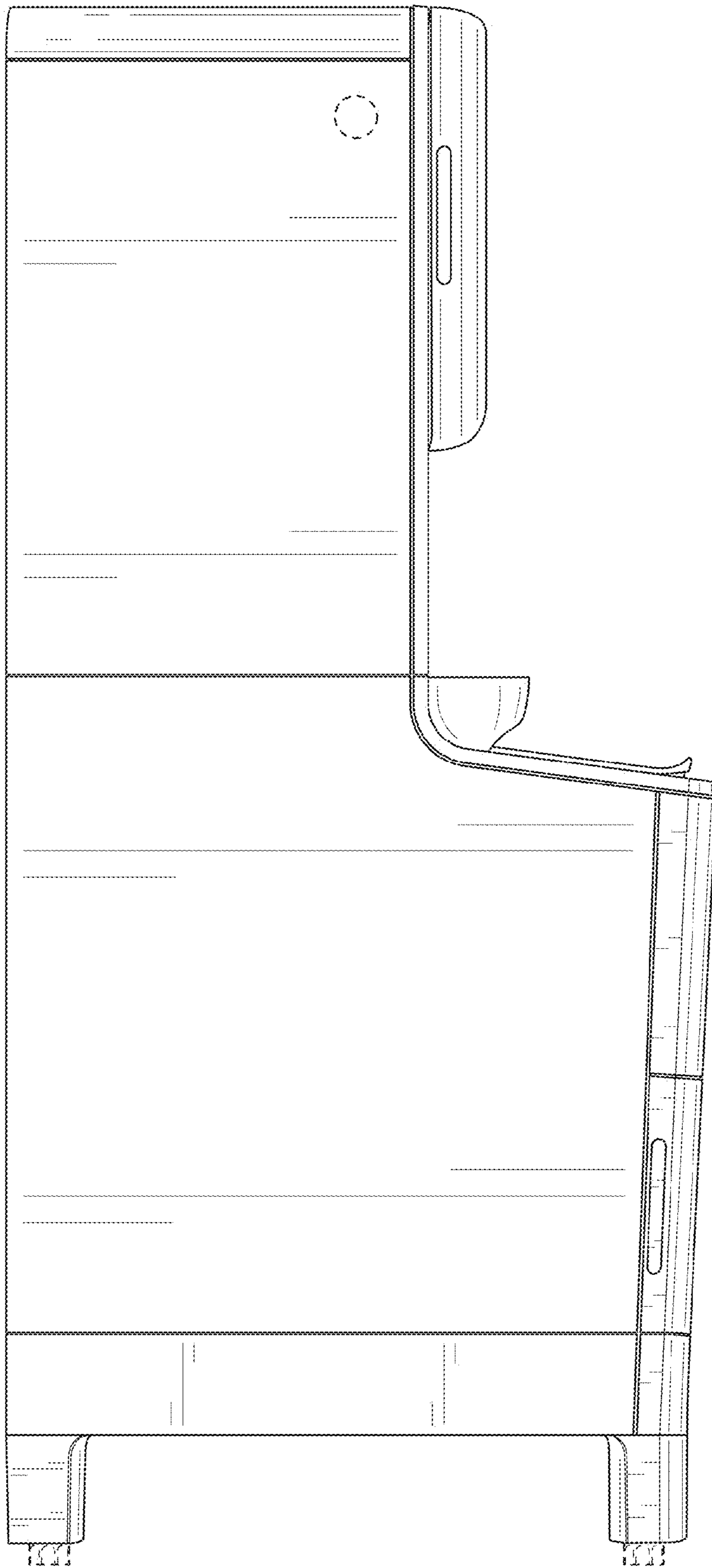

FIG. 5

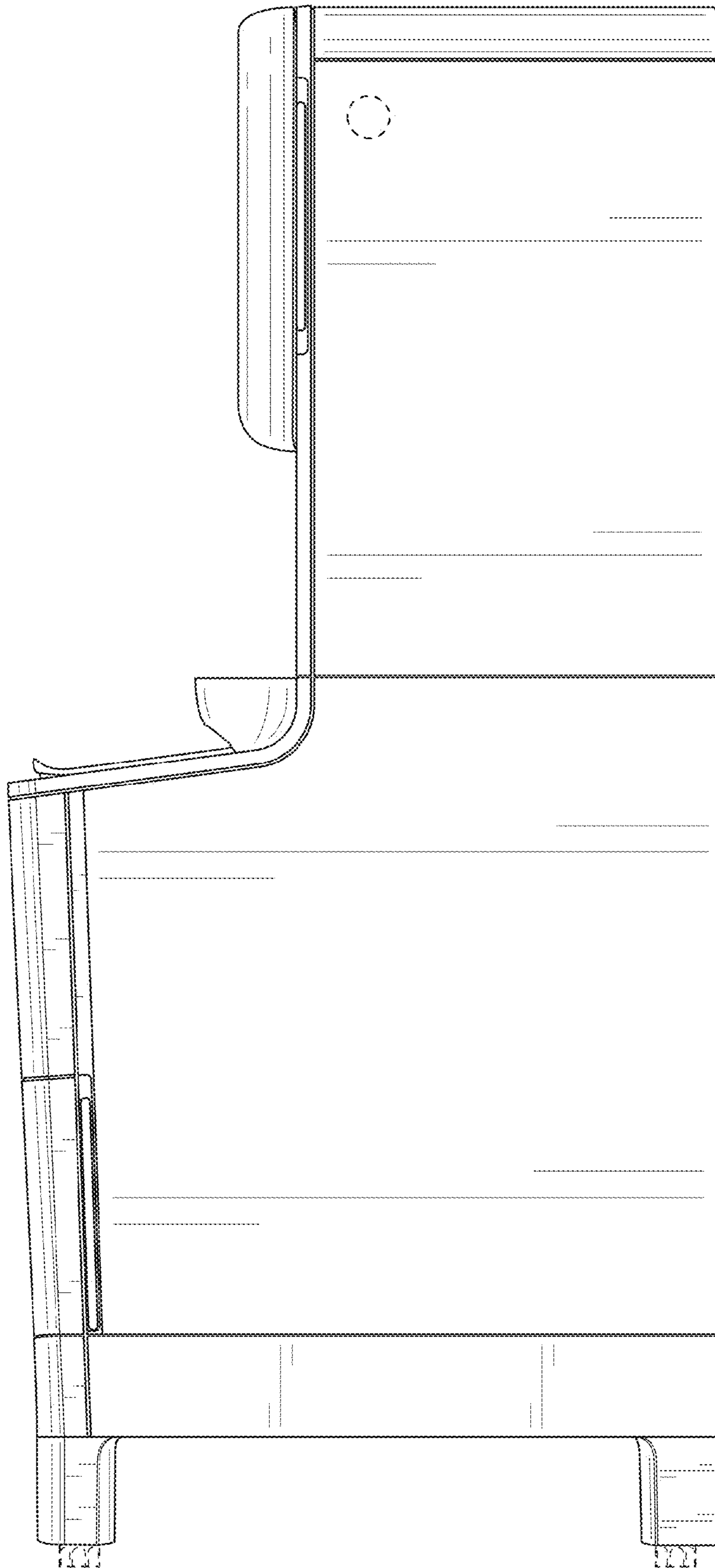

FIG. 6



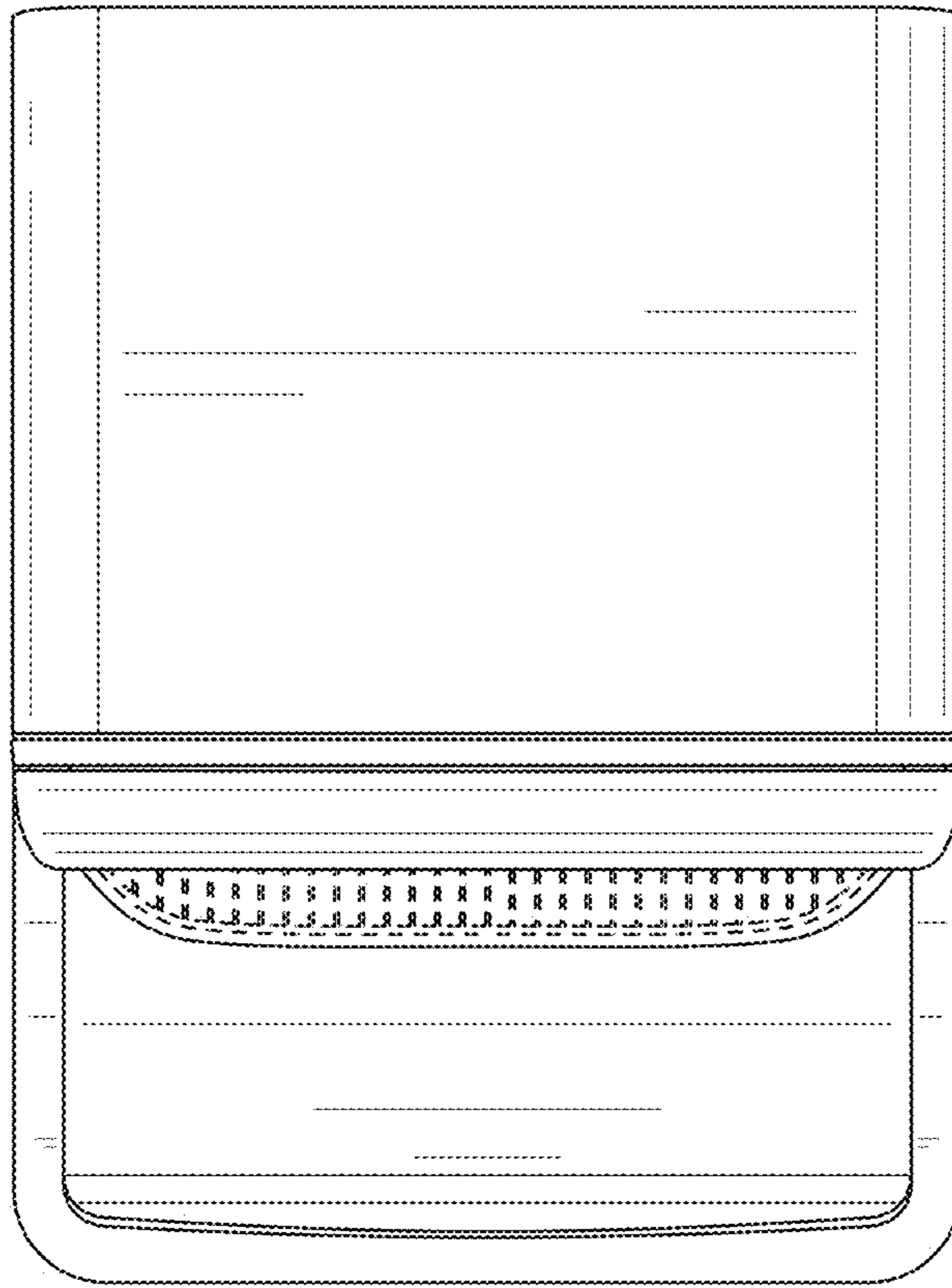

FIG. 7