



US00D959879S

(12) **United States Design Patent** (10) **Patent No.:** **US D959,879 S**
Boucard et al. (45) **Date of Patent:** **** Aug. 9, 2022**

- (54) **TABLE**
- (71) Applicant: **Tesseract Ventures, LLC**, Overland Park, KS (US)
- (72) Inventors: **John Boucard**, Overland Park, KS (US); **Jeffery Chiu**, Overland Park, KS (US); **David Starr**, Overland Park, KS (US)
- (73) Assignee: **Tesseract Ventures, LLC**, Overland Park, KS (US)
- (**) Term: **15 Years**
- (21) Appl. No.: **29/717,857**
- (22) Filed: **Dec. 19, 2019**
- (51) **LOC (13) Cl.** **06-03**
- (52) **U.S. Cl.**
USPC **D6/656.16**
- (58) **Field of Classification Search**
USPC D6/349, 641, 653.17, 654.17, 655.17, D6/656, 656.1, 656.13, 656.14, 656.16, D6/656.18, 675, 685, 686, 690, 691, D6/691.2, 691.5, 691.8, 694
CPC A47B 47/00; A47B 13/00; A47B 13/02; A47B 13/04; A47B 13/06; A47B 13/08; A47B 13/10; A47B 13/12; A47B 21/00; A47B 2200/0001; A47B 2200/0011; A47B 2200/002
See application file for complete search history.

(56) **References Cited**

U.S. PATENT DOCUMENTS

- D227,329 S * 6/1973 Grossman D6/690
- D233,971 S * 12/1974 Hodges D6/691.8
- D240,184 S * 6/1976 Neuschaefer D6/656.1
- D242,001 S * 10/1976 Carter D6/691.2
- D258,736 S * 3/1981 Genaro D14/472
- D258,789 S * 4/1981 Verdesca D6/655.17
- D270,217 S * 8/1983 Daventry D6/656.16

- D278,771 S * 5/1985 Koguma D6/656.1
- D281,746 S * 12/1985 Koguma D6/656
- D549,492 S * 8/2007 Sheppard D6/691.8
- D693,610 S * 11/2013 Denby D6/690
- D734,964 S * 7/2015 Ward D6/656.1
- D765,450 S * 9/2016 Biddle D6/691
- D774,807 S * 12/2016 Biddle D6/691
- D792,135 S * 7/2017 Wyman D6/691.1
- D810,482 S * 2/2018 Modlin D6/691
- D815,474 S * 4/2018 Modlin D6/691.2

(Continued)

OTHER PUBLICATIONS

“YouTube—Tesseract Ventures Smart Room.” Found online Jan. 14, 2022 at [www.youtube.com](https://www.youtube.com/watch?v=0AMxwnEII-c). Video published Dec. 17, 2020. Retrieved from URL: <https://www.youtube.com/watch?v=0AMxwnEII-c> (Year: 2020).*

(Continued)

Primary Examiner — Michael C Stout
Assistant Examiner — Katelin G Kloberg
(74) *Attorney, Agent, or Firm* — Polsinelli PC

(57) **CLAIM**

We claim the ornamental design for a table, as shown and described.

DESCRIPTION

FIG. 1 is a top perspective view of a table, showing our new design;
FIG. 2 is a front elevational view thereof;
FIG. 3 is a rear elevational view thereof;
FIG. 4 is a left side elevational view thereof;
FIG. 5 is a right side elevational view thereof;
FIG. 6 is a top plan view thereof;
FIG. 7 is a bottom plan view thereof; and,
FIG. 8 is a bottom perspective view thereof.
The broken lines in the drawings depict portions of the table that form no part of the claimed design.

1 Claim, 8 Drawing Sheets

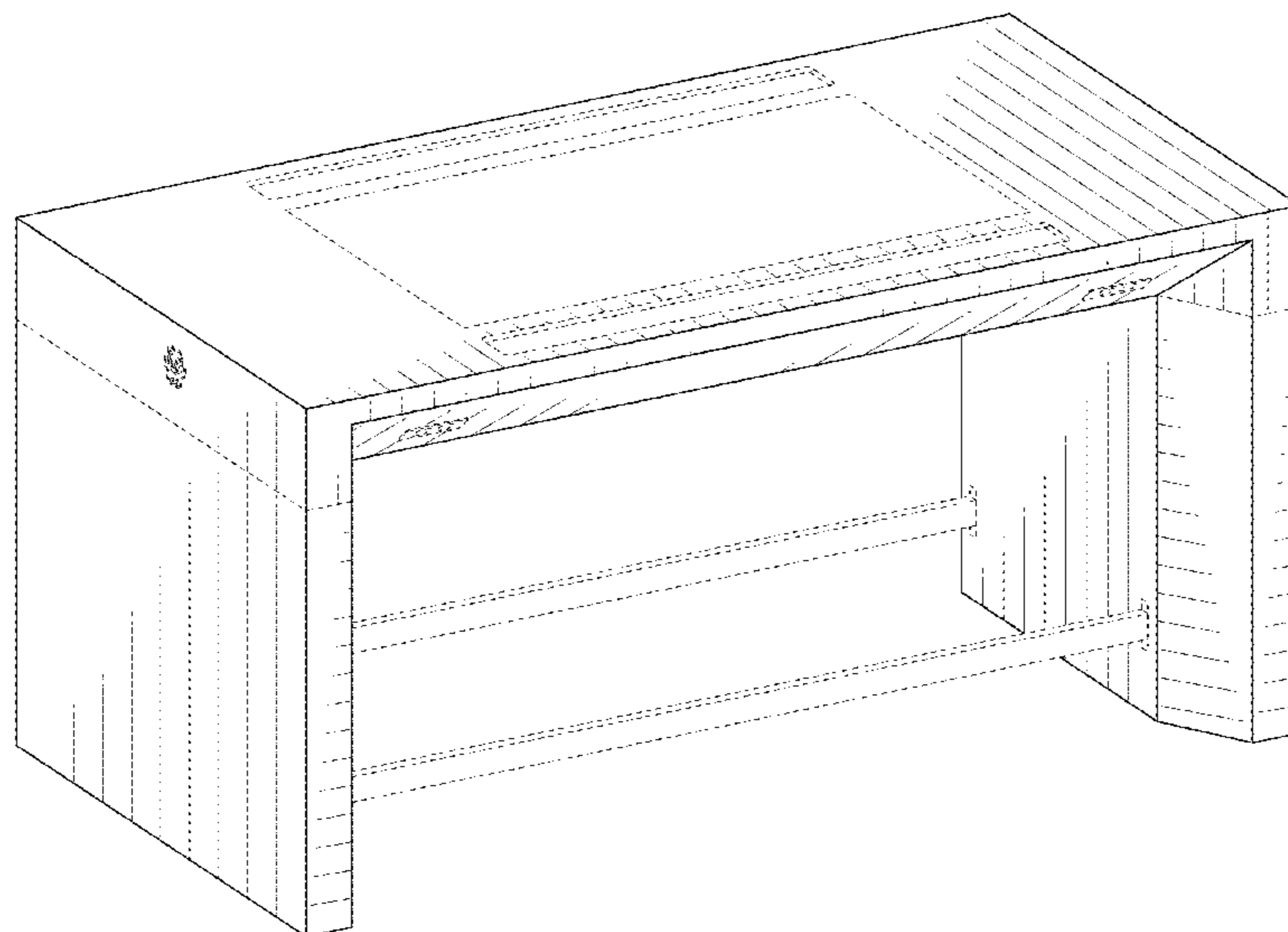

(56)

References Cited

U.S. PATENT DOCUMENTS

D843,761 S * 3/2019 Chang D6/705
D889,886 S * 7/2020 Birch D6/657
D923,381 S * 6/2021 Bergsma D6/719
D926,504 S * 8/2021 Van Faasen D6/691
D933,401 S * 10/2021 Polidoros D6/656.1
2020/0077784 A1 * 3/2020 Polidoros A47B 3/08
2020/0077789 A1 * 3/2020 Polidoros A47B 1/04

OTHER PUBLICATIONS

“Waterfall Desk or Table.” Found online Jan. 14, 2022 at www.custommade.com. Product reviewed Jul. 31, 2017. Retrieved from URL: <https://www.custommade.com/chester-county-chest-of-drawers/by/kingswoodfinefurniture/> (Year: 2017).*

“Big-table-collaborative-space.” Found online Jan. 14, 2022 at www.myturnstone.com. Page dated Nov. 5, 2015. Retrieved from URL: <https://myturnstone.com/big-table-collaborative-space/> (Year: 2015).*

* cited by examiner

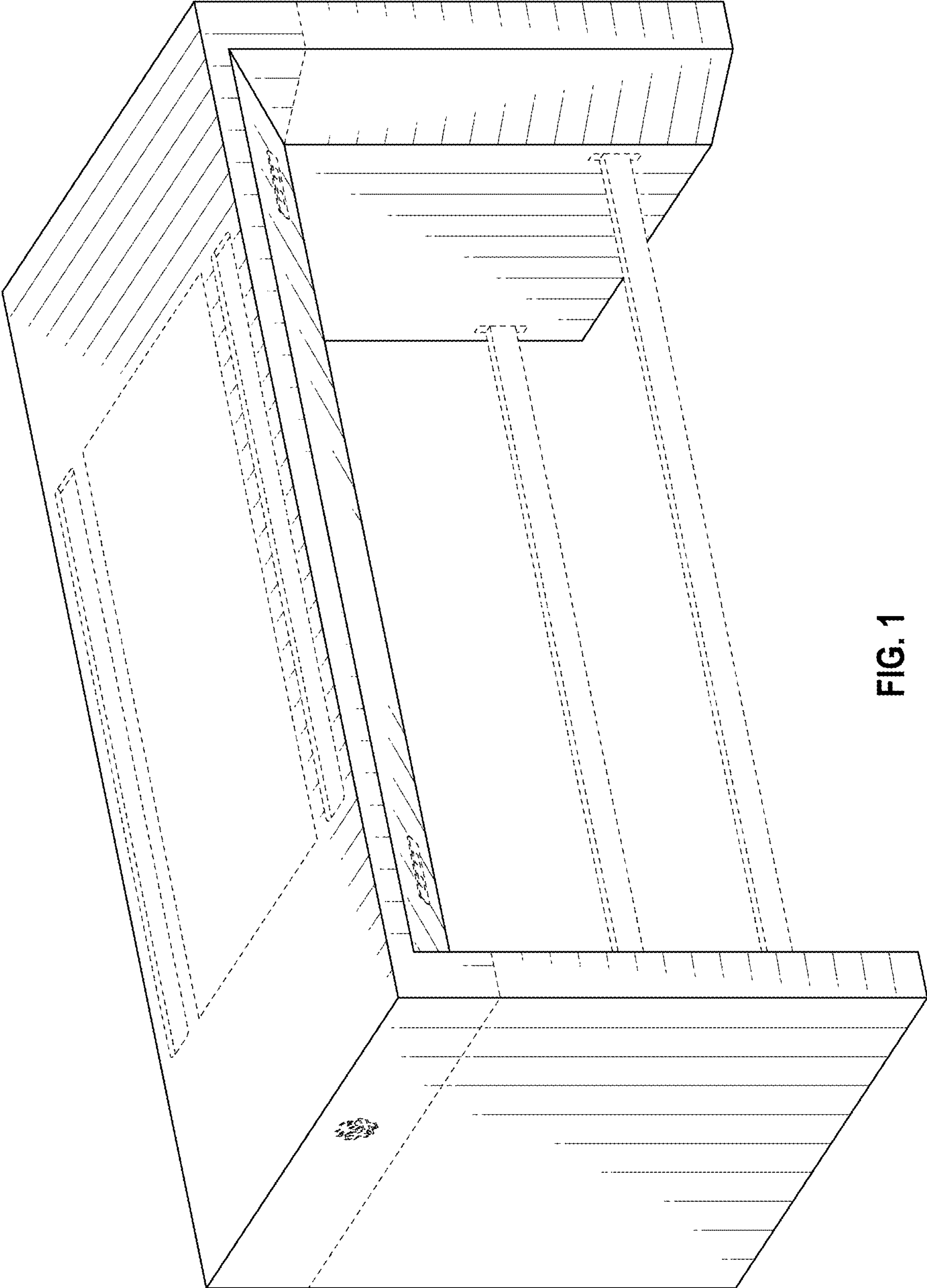

FIG. 1

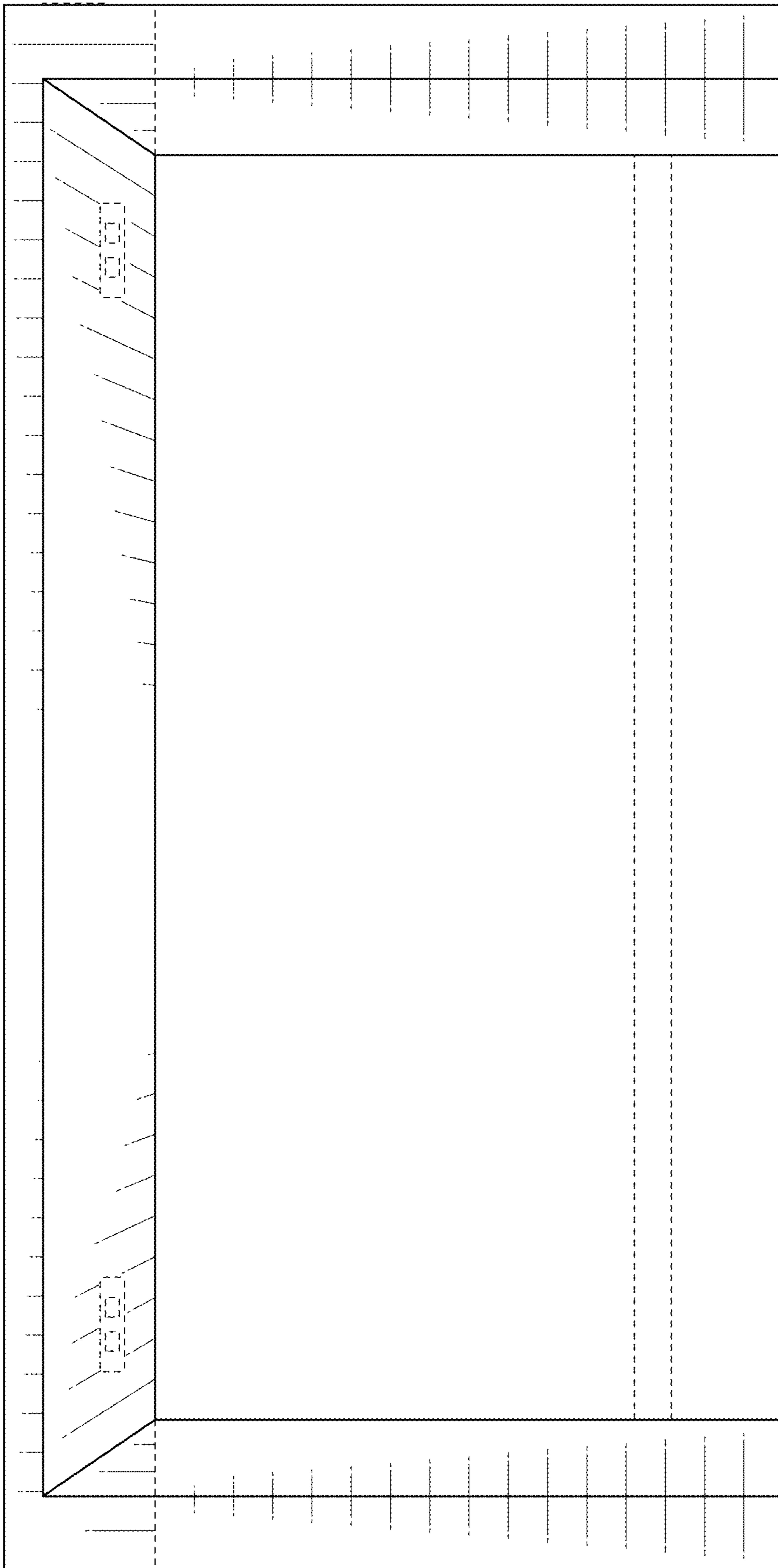

FIG. 2

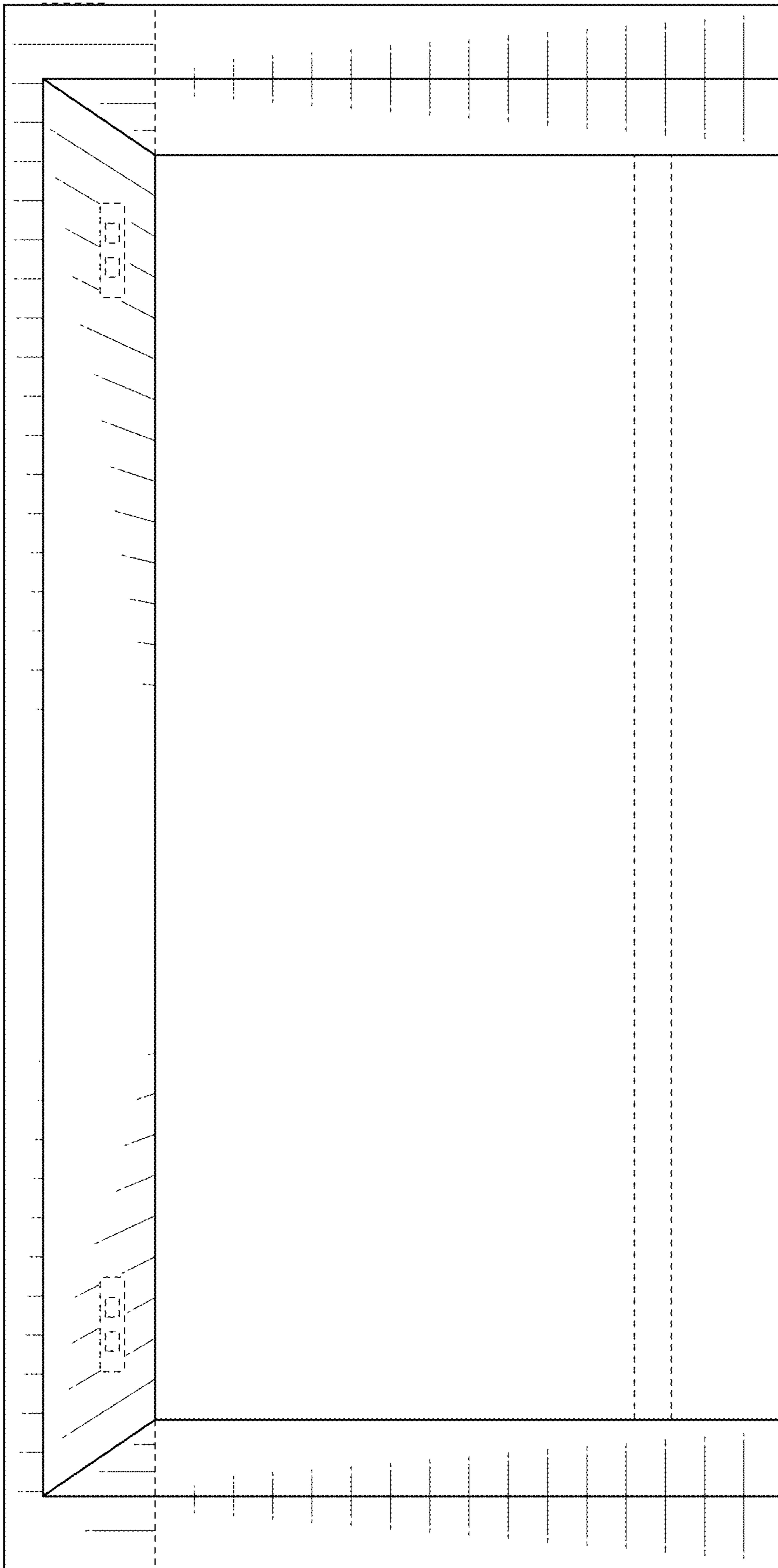

FIG. 3

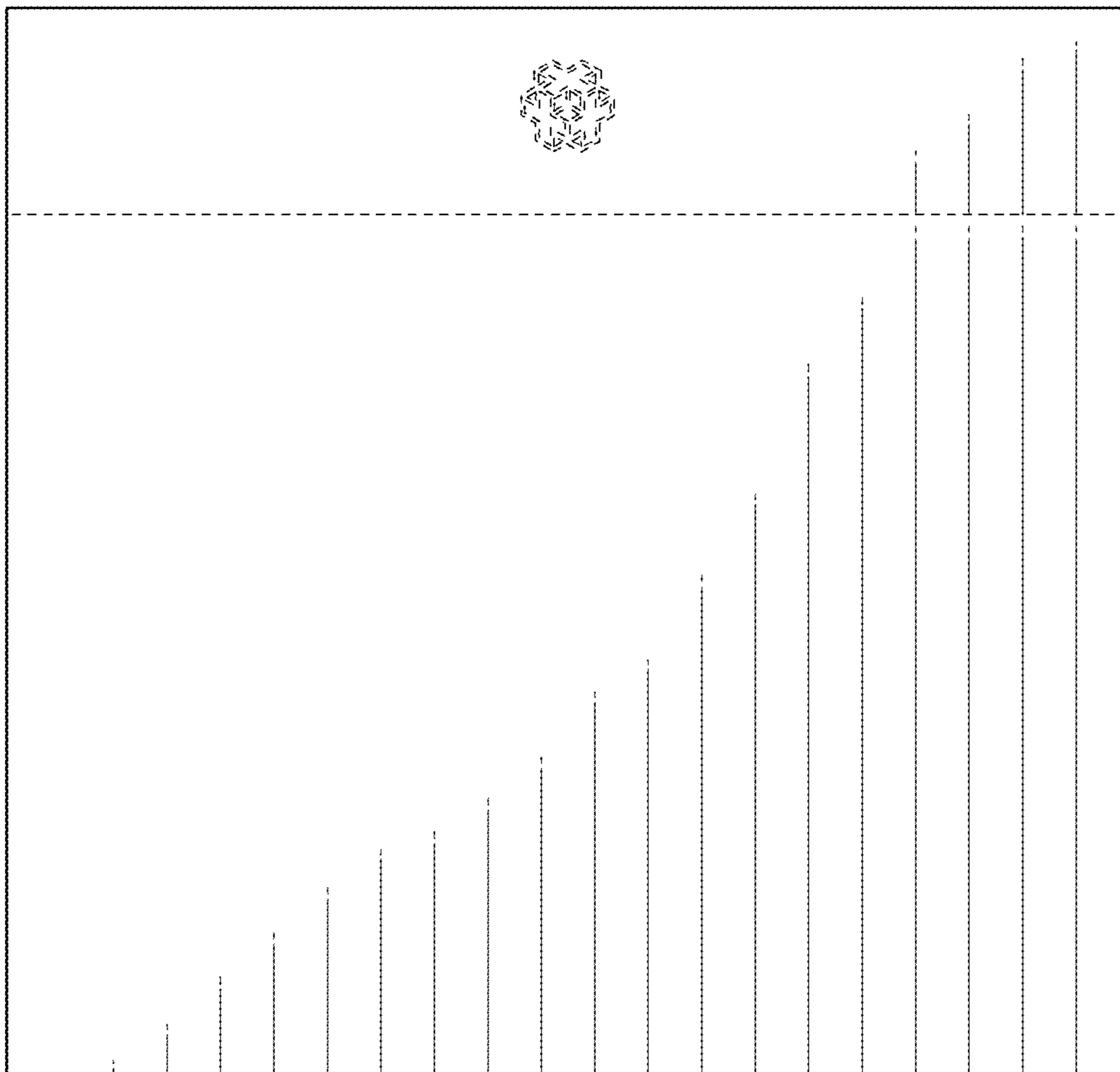

FIG. 4

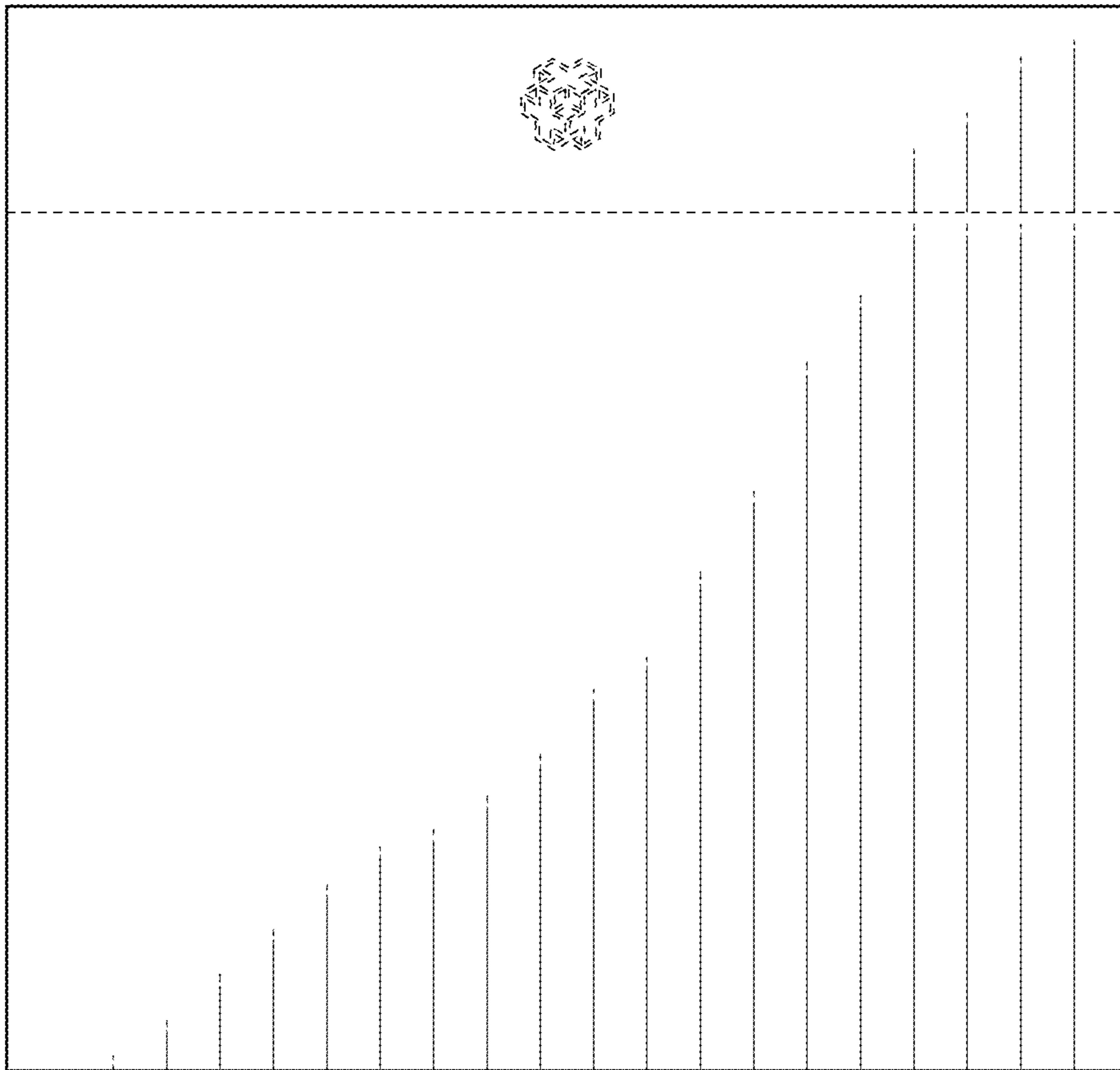

FIG. 5

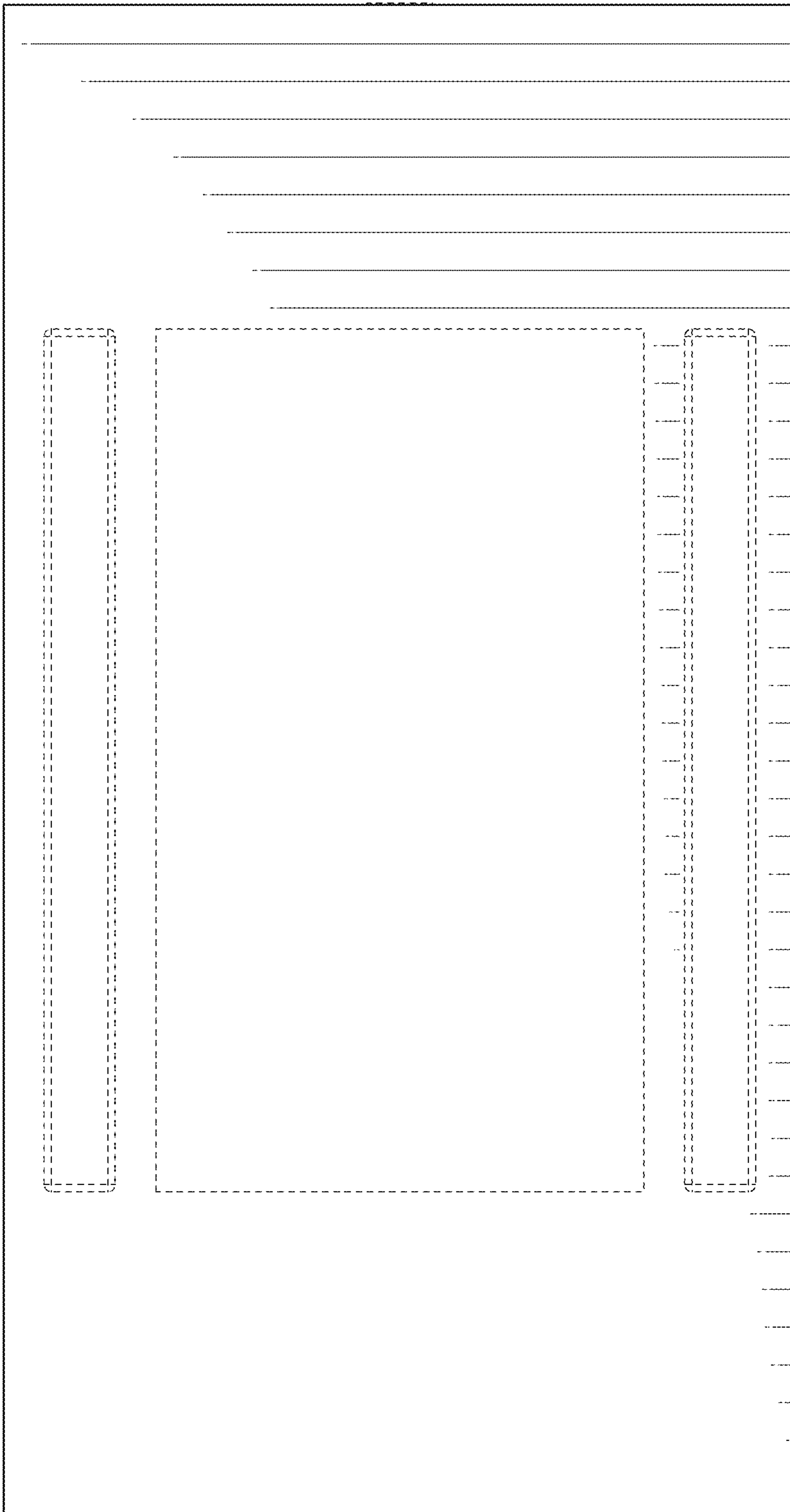

FIG. 6

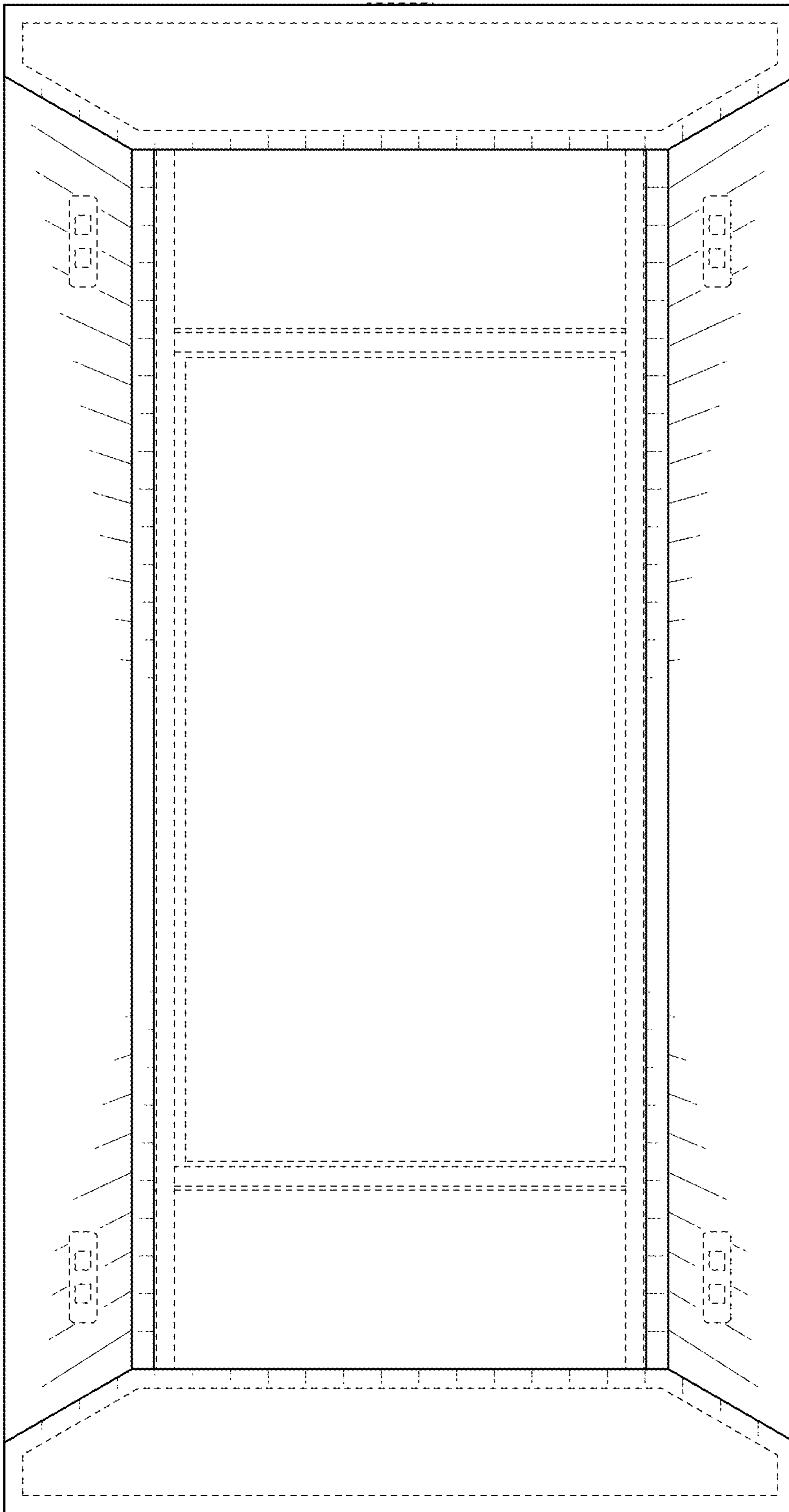

FIG. 7

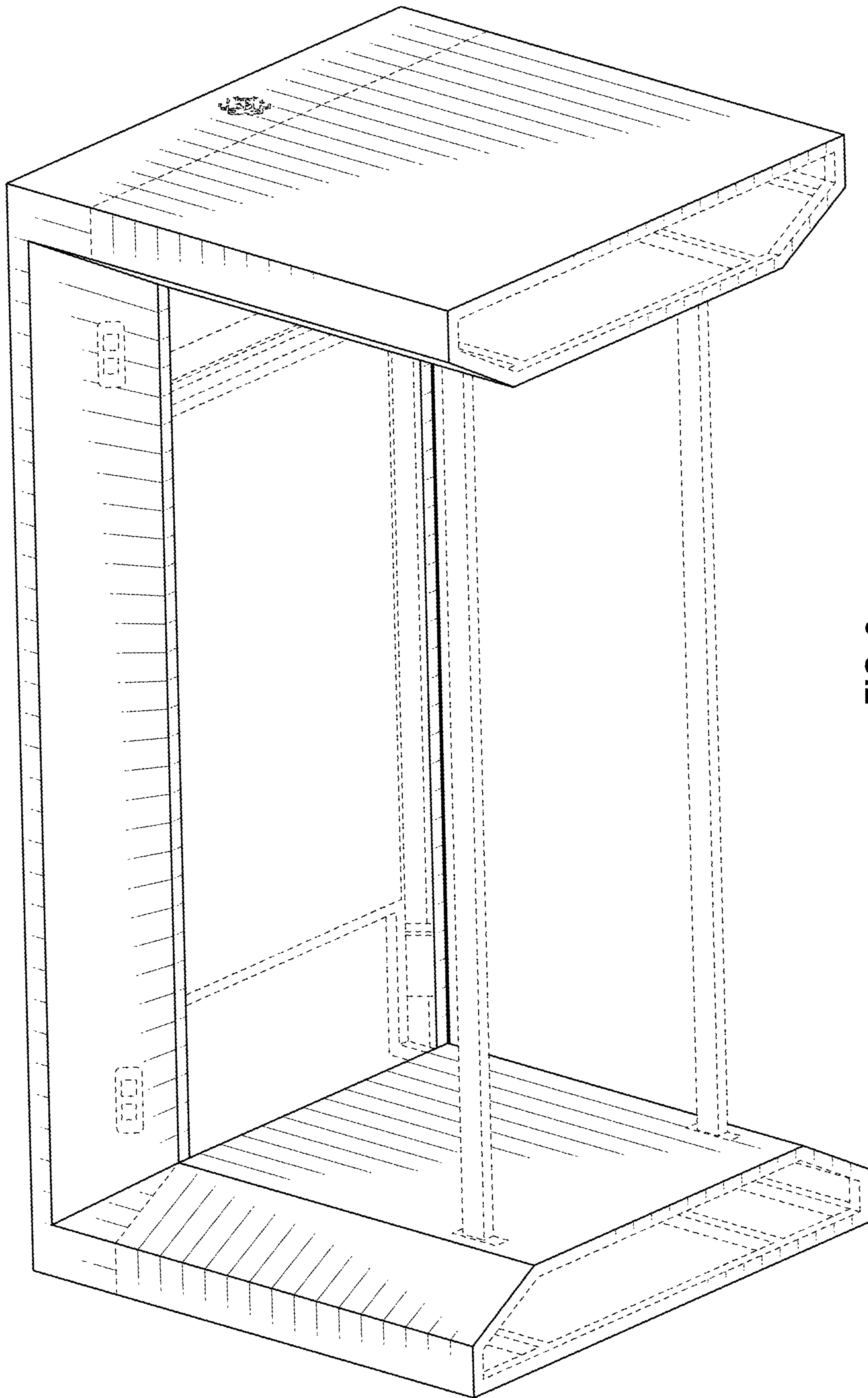

FIG. 8