



US00D959798S

(12) **United States Design Patent**  
**Morrissey et al.**

(10) **Patent No.:** **US D959,798 S**

(45) **Date of Patent:** **\*\* Aug. 9, 2022**

(54) **LOUNGEWEAR TOP**

(71) Applicant: **JJ WINKS, LLC**, Huntington Beach, CA (US)

(72) Inventors: **Kelly Morrissey**, Huntington Beach, CA (US); **Lisa Loyd**, Huntington Beach, CA (US)

(\*\*) Term: **15 Years**

(21) Appl. No.: **29/750,589**

(22) Filed: **Sep. 15, 2020**

(51) **LOC (13) Cl.** ..... **02-02**

(52) **U.S. Cl.**  
USPC ..... **D2/731; D2/840**

(58) **Field of Classification Search**  
USPC ..... D2/700, 701, 702, 703, 705, 706, 707,  
D2/718, 721, 723, 731, 829, 840, 841,  
D2/845

(Continued)

(56) **References Cited**

**U.S. PATENT DOCUMENTS**

D654,665 S \* 2/2012 Lam ..... D2/840  
D669,660 S \* 10/2012 Savage ..... D2/840

(Continued)

**OTHER PUBLICATIONS**

Slumber Party Top, [online]; [review published to the internet on Nov. 10, 2020]; [retrieved from the internet on Mar. 23, 2022]; URL: <https://jjwinks.com/collections/tops/products/copy-of-slumber-party-top-1>. (6 pages). (Year: 2020).\*

(Continued)

*Primary Examiner* — Jasmine Mlinarcik

(74) *Attorney, Agent, or Firm* — David Duckworth; One LLP

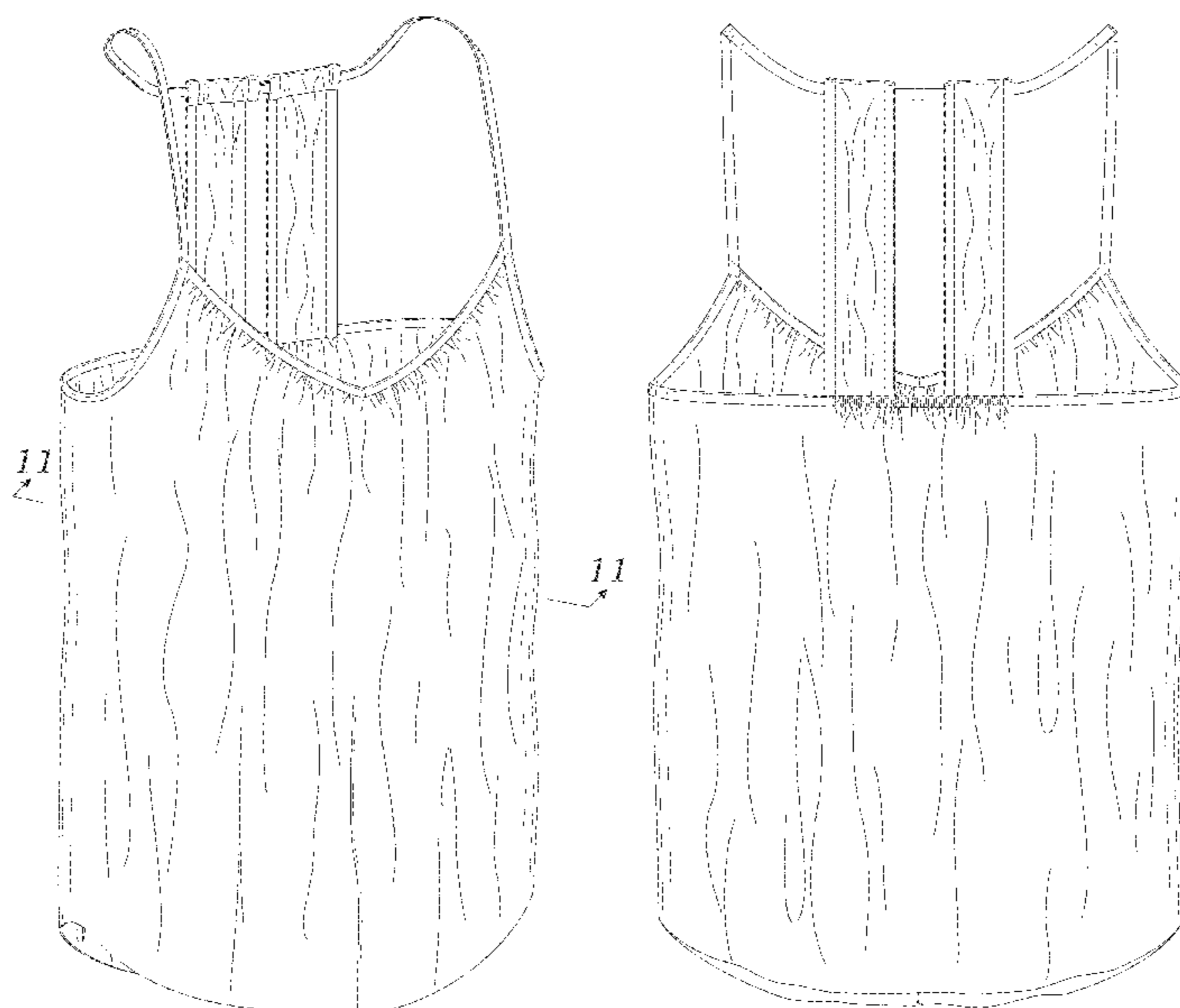
(57) **CLAIM**

The ornamental design for a loungewear top, as shown and described.

**DESCRIPTION**

FIG. 1 is a top left side perspective view of the loungewear top of my design;  
FIG. 2 is a front elevation view thereof;  
FIG. 3 is a rear elevation view thereof;  
FIG. 4 is a left side elevation view thereof;  
FIG. 5 is a right side elevation view thereof;  
FIG. 6 is a top plan view thereof;  
FIG. 7 is a bottom plan view thereof;  
FIG. 8 is a top left side perspective view of my design illustrating the outer layer pulled upwardly;  
FIG. 9 is a top left side perspective view of the loungewear top shown in FIG. 8 wherein the upper region of the top is shown in hidden lines;  
FIG. 10 is a top left perspective view of my design wherein the lower region of the garment which has been pulled upwardly and is shown in hidden lines;  
FIG. 11 is a left side elevation cutaway view of the loungewear top taken from lines 11-11 in FIG. 1;  
FIG. 12 is a top left side perspective view of my design wherein the loungewear top's vertical straps have been moved horizontally outward to illustrate the adjustable horizontal strap;  
FIG. 13 is a left side perspective view of the horizontal adjustable strap taken from line 13 in FIG. 12; and,  
FIG. 14 is a left side perspective view of the horizontal strap shown in FIG. 13 wherein the strap is in an open condition. The broken line outline of the loungewear top described as hidden lines in the figure descriptions of FIGS. 9 and 10 is included to show the loungewear top in alternative configuration for clarity of illustration. The broken line outline of the features along the straps of the loungewear top in FIGS. 12-14 depict features of the article that form no part of the claimed design.

**1 Claim, 11 Drawing Sheets**



(58) **Field of Classification Search**

CPC .... A41B 1/00; A41B 1/02; A41B 1/04; A41D  
1/04; A41D 1/22; A41D 7/00; A41D  
13/0015; A41D 13/0017; A41D 15/00;  
A41D 15/005; A41D 2400/38; A41C  
3/00; A41C 3/0007; A41C 3/0021; A41C  
3/0057; A41C 3/08

See application file for complete search history.

(56) **References Cited**

U.S. PATENT DOCUMENTS

D701,675 S \* 4/2014 Waldman ..... D2/735  
D721,872 S \* 2/2015 Cooper ..... D2/840  
9,022,833 B2 \* 5/2015 Deming ..... A41D 13/1245  
450/30  
D731,749 S \* 6/2015 Waldman ..... D2/736  
D746,021 S \* 12/2015 Saylor ..... D2/731  
D816,946 S \* 5/2018 Waldman ..... D2/731  
D846,835 S \* 4/2019 Waldman ..... D2/731  
D847,459 S \* 5/2019 Waldman ..... D2/731  
D861,291 S \* 10/2019 Waldman ..... D2/731  
D862,041 S \* 10/2019 Waldman ..... D2/731  
D899,029 S \* 10/2020 Terrell ..... D2/850

OTHER PUBLICATIONS

Lafaris Plus Size Workout Tank Tops with Built in Bra Camisole for Women, [online]; [date first available to the internet on Mar. 12, 2021]; [retrieved from the internet on Mar. 23, 2022]; URL: [https://www.amazon.com/Lafaris-Moisture-Lightweight-Breathable-Flattering/dp/B08YRF7F55?ref\\_ast\\_sto\\_dp&th=1&psc=1](https://www.amazon.com/Lafaris-Moisture-Lightweight-Breathable-Flattering/dp/B08YRF7F55?ref_ast_sto_dp&th=1&psc=1). (6 pages).\*

\* cited by examiner

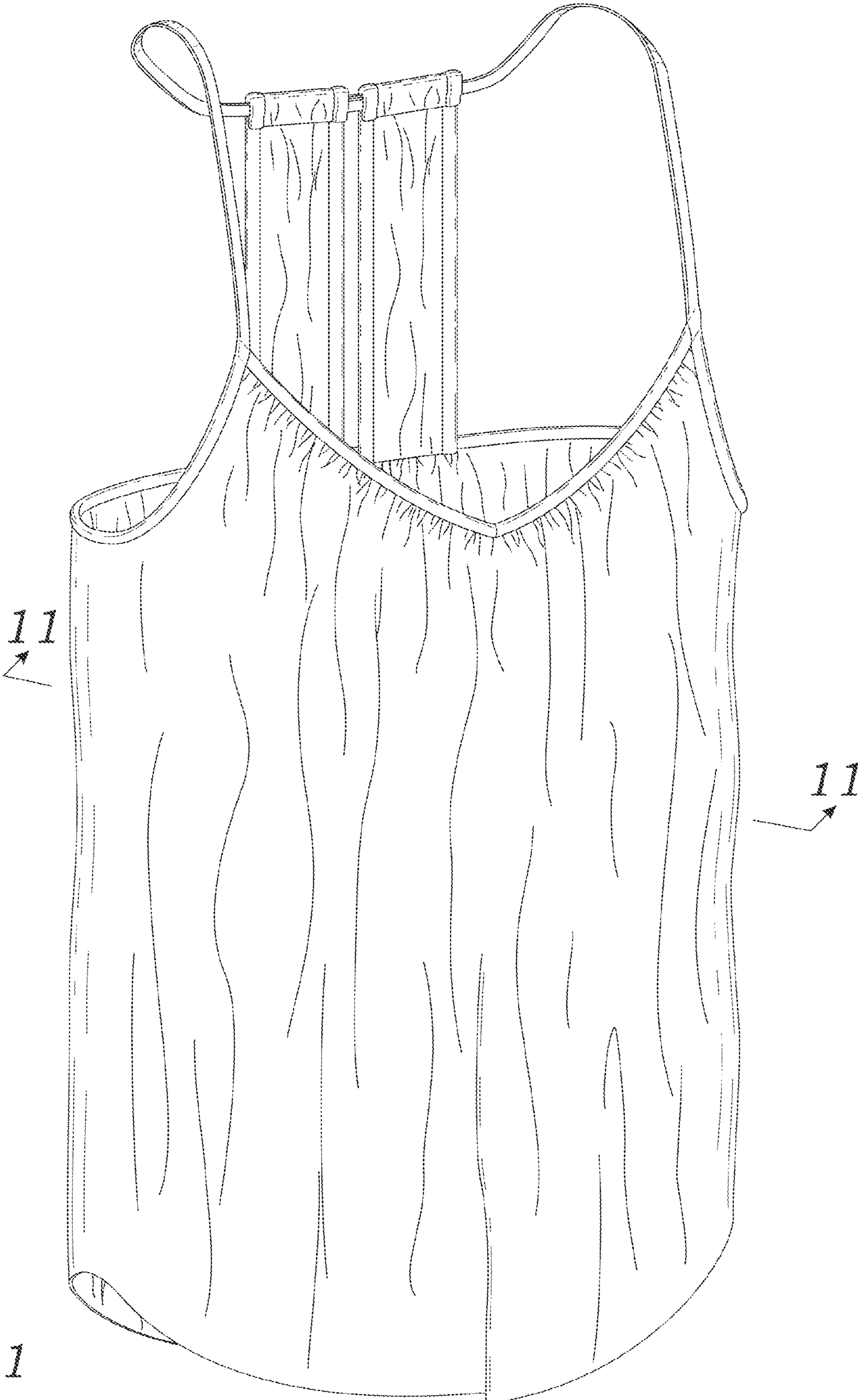
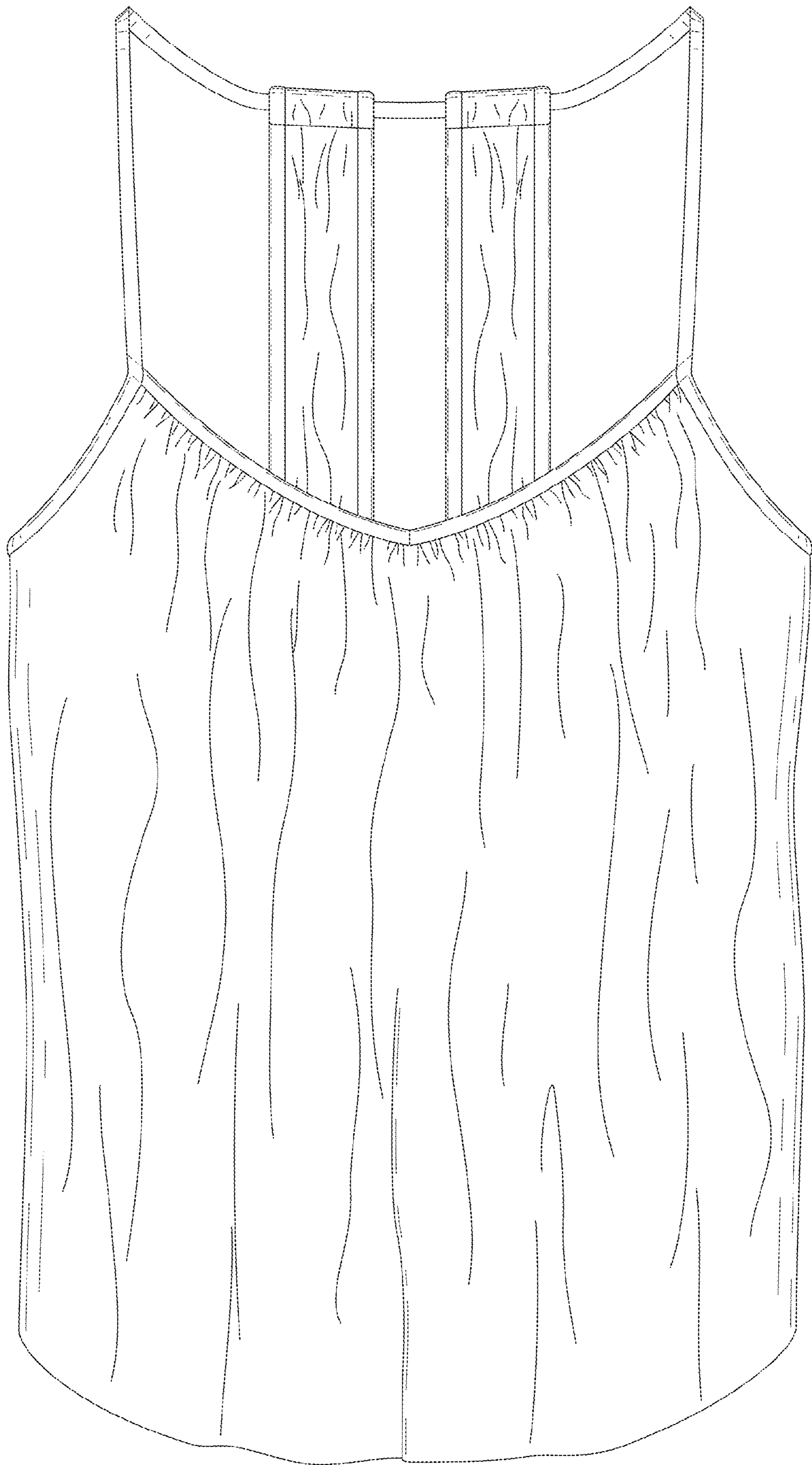
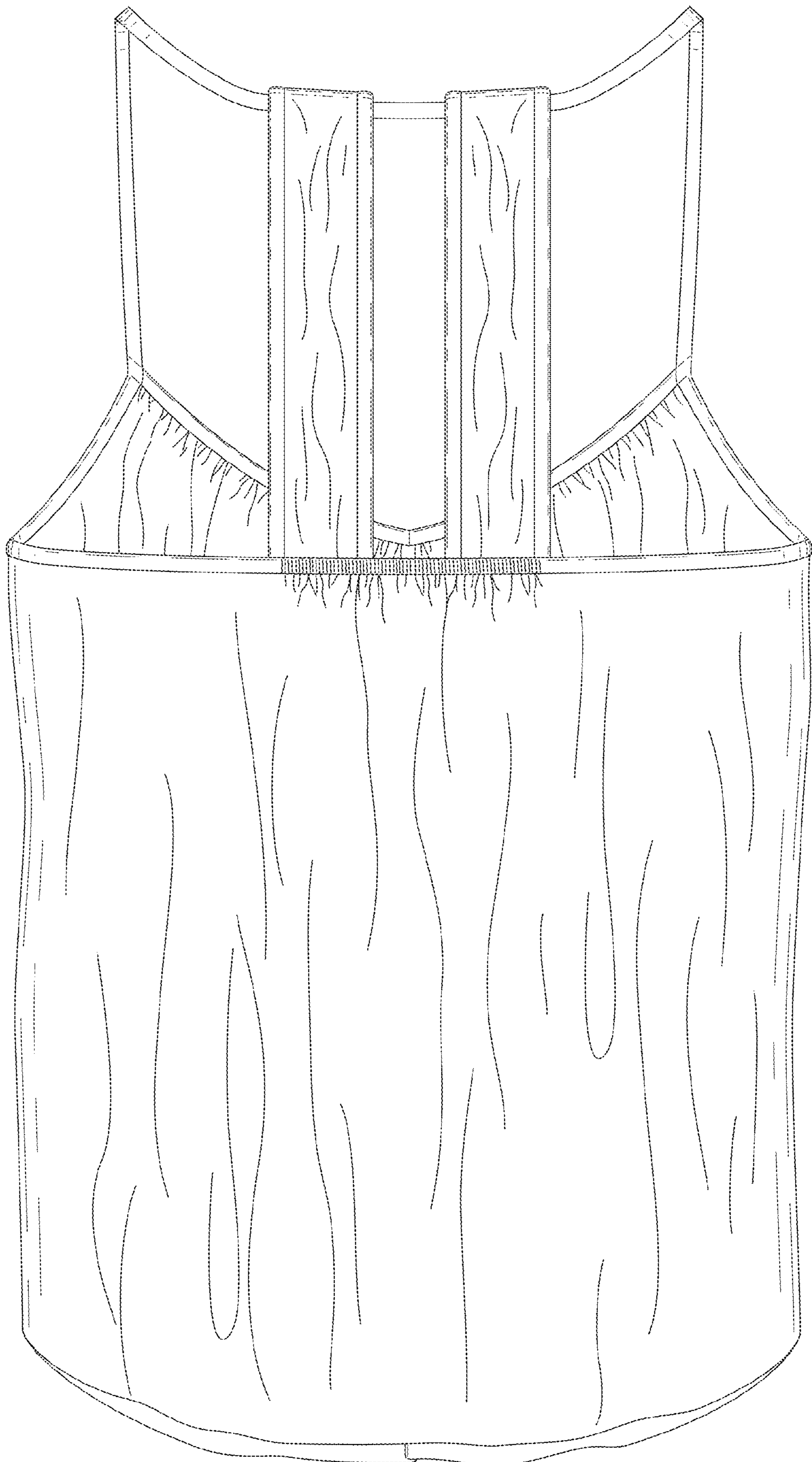


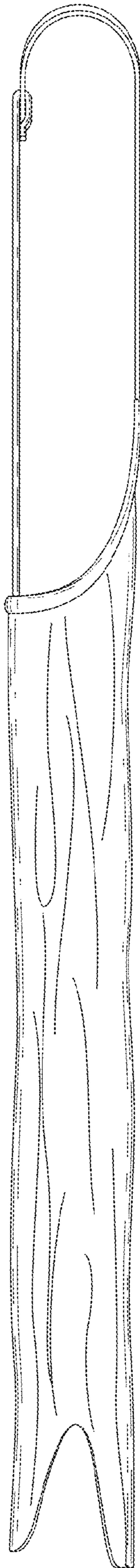
Fig. 1



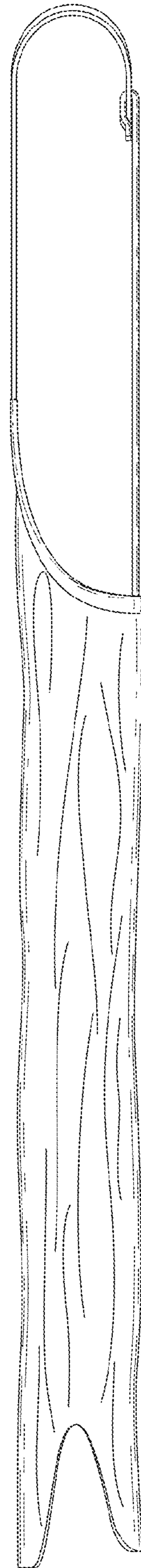
*Fig. 2*



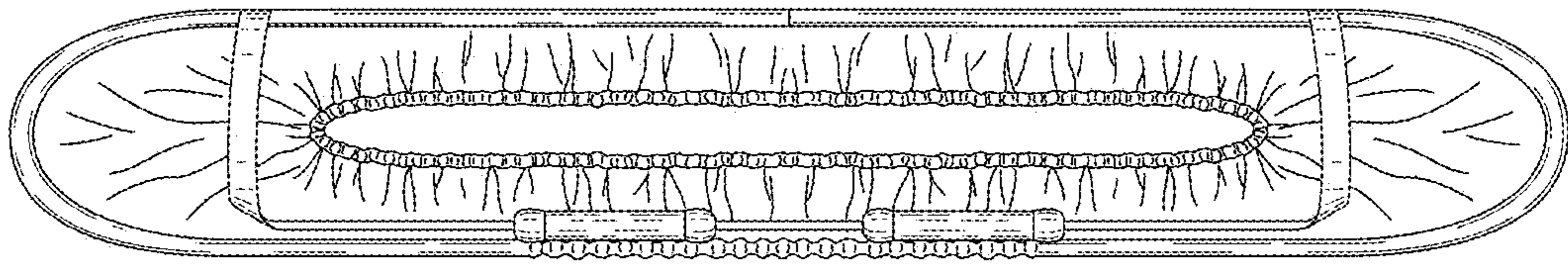
*Fig. 3*



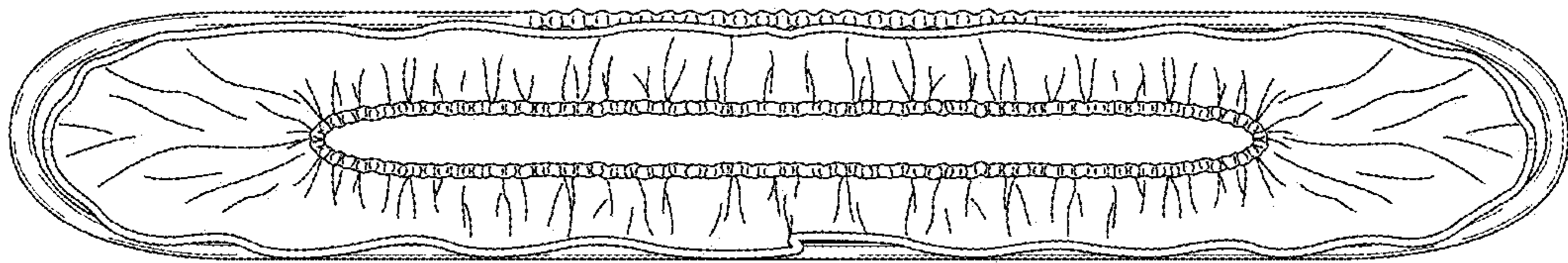
*Fig. 4*



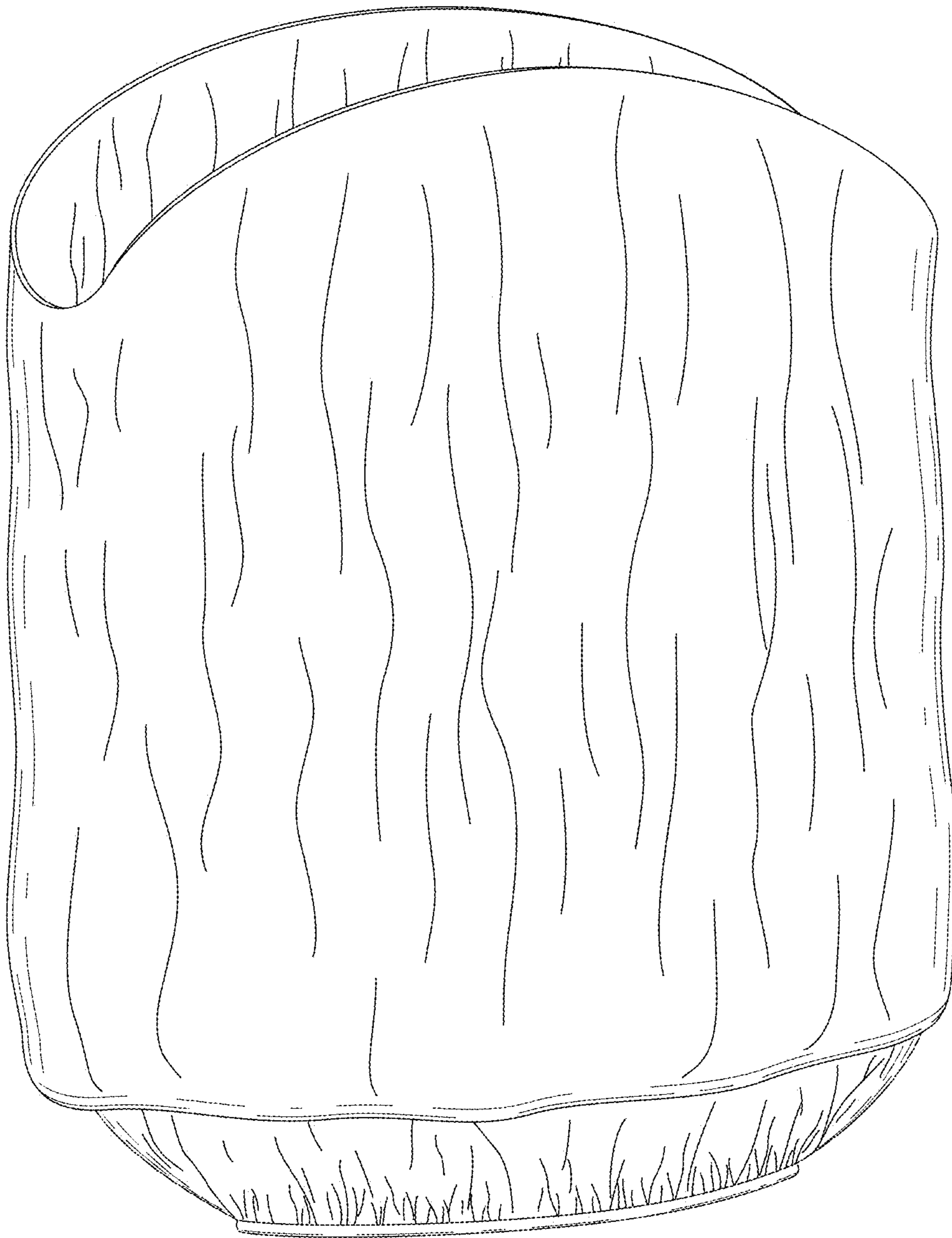
*Fig. 5*



*Fig. 6*

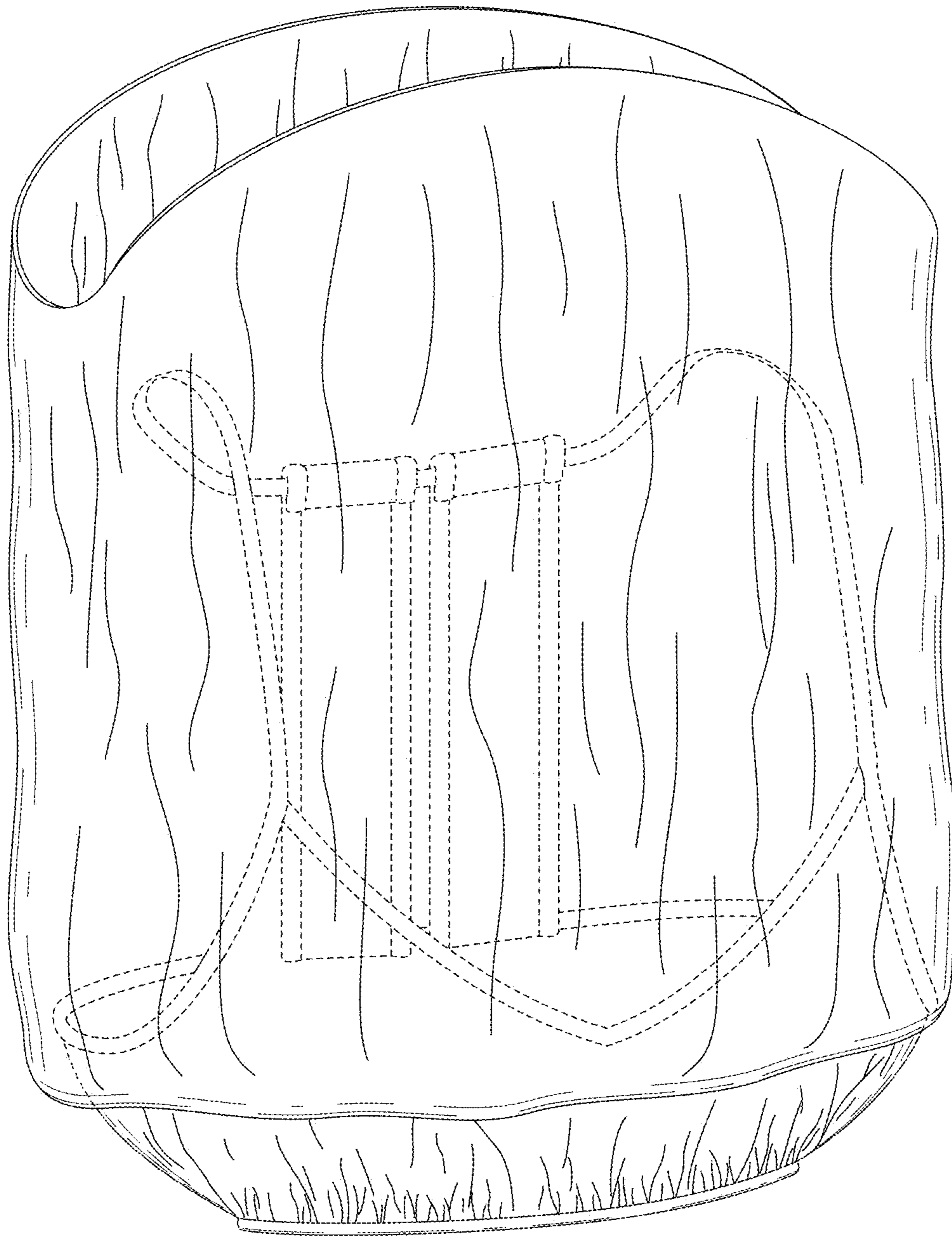


*Fig. 7*

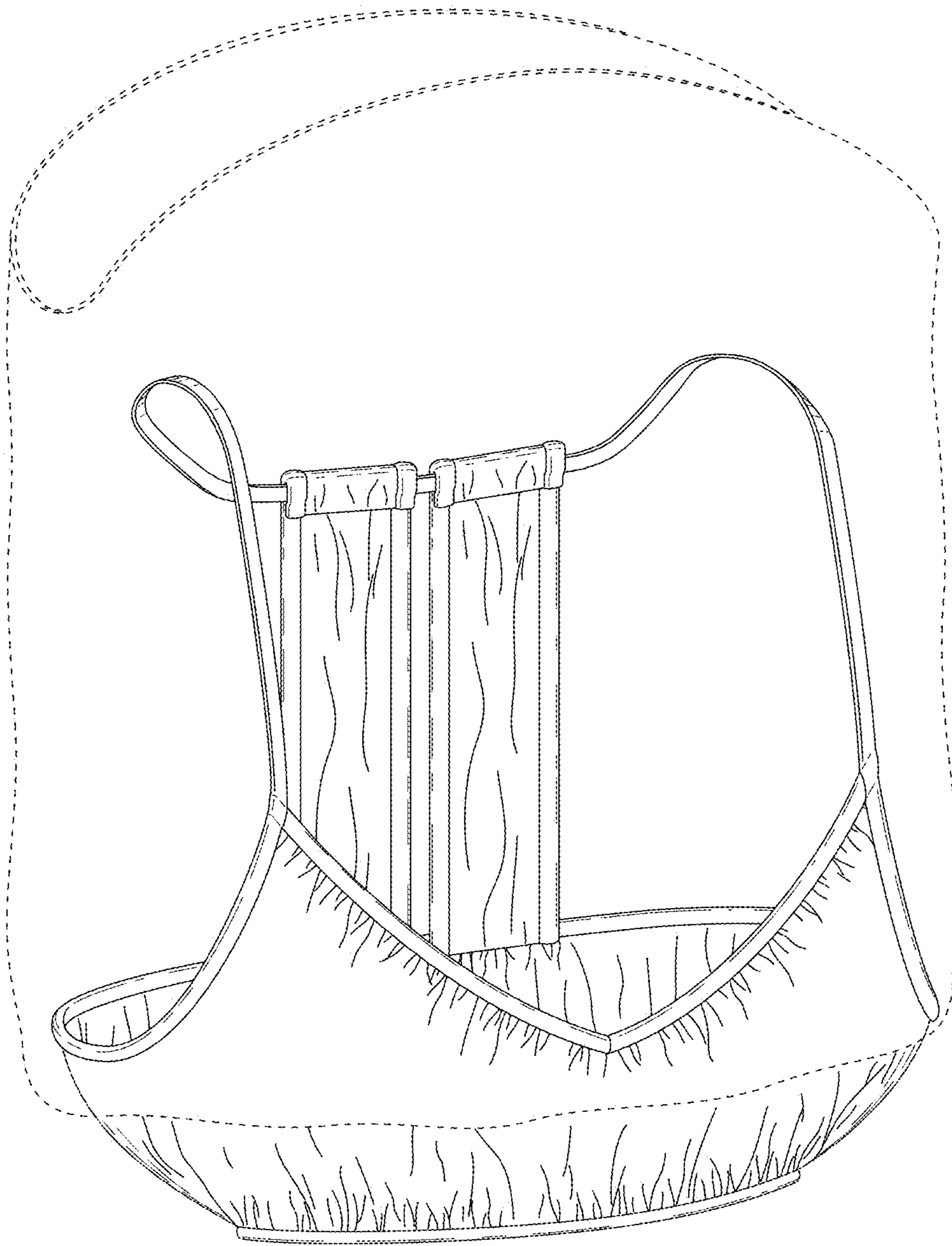


*Fig. 8*

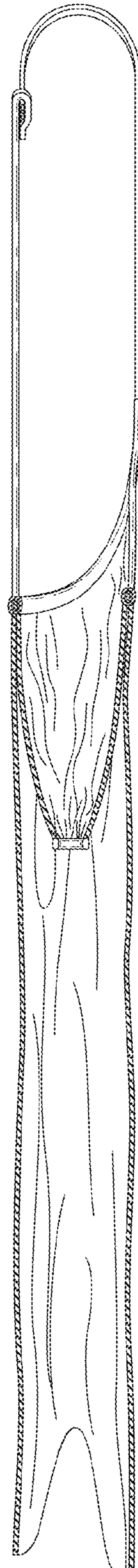




*Fig. 9*



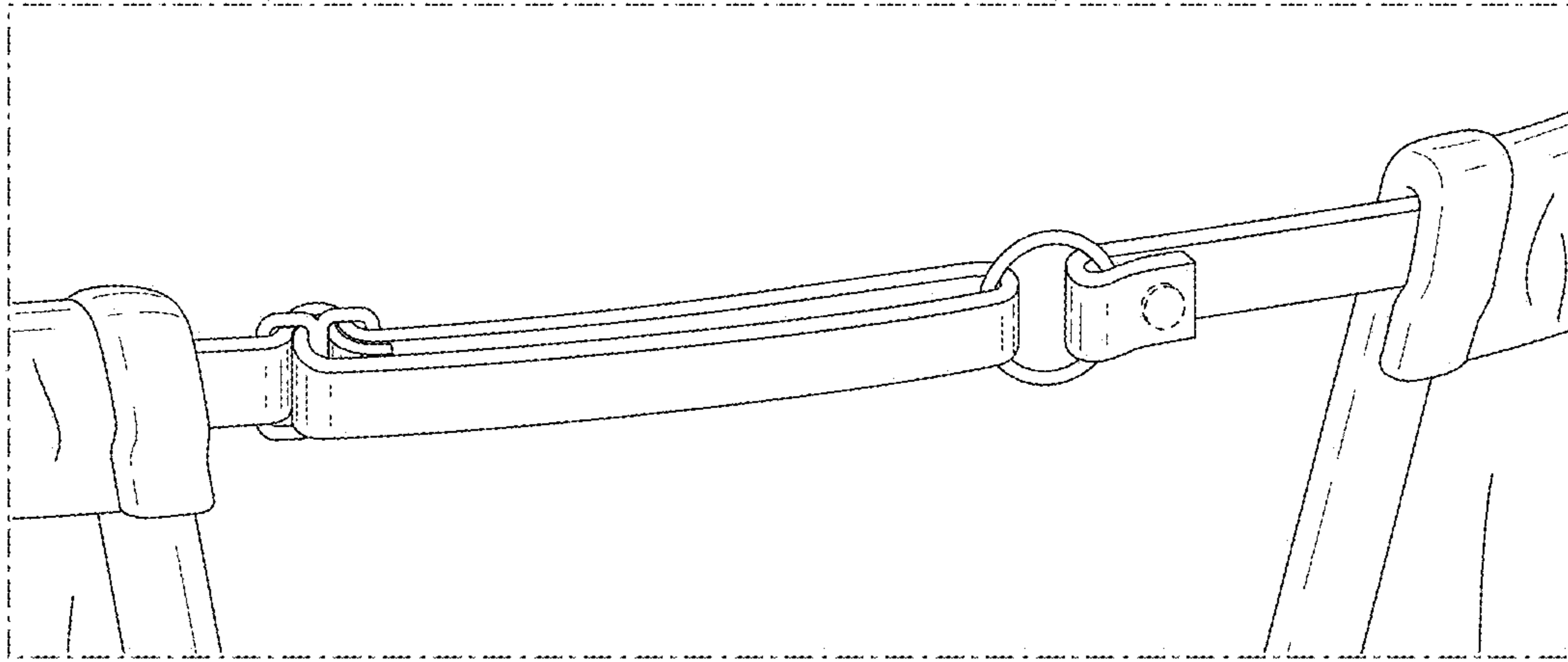
*Fig. 10*



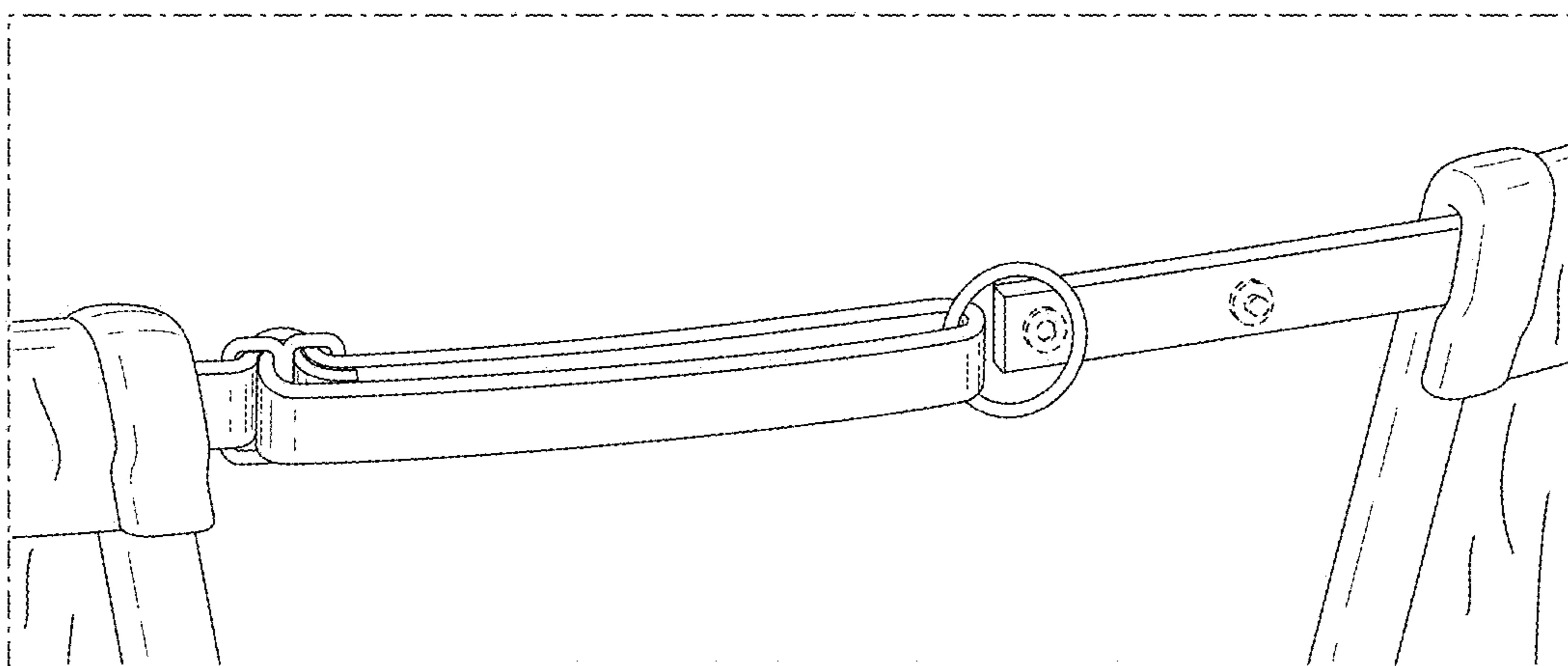
*Fig. 11*



*Fig. 12*



*Fig. 13*



*Fig. 14*