



US00D959678S

(12) **United States Design Patent** (10) **Patent No.:** **US D959,678 S**
Caneppele et al. (45) **Date of Patent:** **** Aug. 2, 2022**

(54) **ADHESIVE BANDAGE WITH DECORATED PAD**

(56) **References Cited**

U.S. PATENT DOCUMENTS

(71) Applicant: **Johnson & Johnson Consumer Inc.,**
Skillman, NJ (US)

D65,736 S	10/1924	Groman
2,096,564 A	10/1937	Scholl
D127,402 S	11/1940	Schwartz
D183,699 S	10/1958	Martin
2,877,765 A	3/1959	Bunyan
2,905,174 A	9/1959	Smith
2,924,331 A	2/1960	Hoey
2,946,435 A	7/1960	Schladermundt et al.
3,655,501 A	4/1972	Tesch
3,728,206 A	4/1973	Buese
4,541,426 A	9/1985	Webster
4,545,339 A	10/1985	Kubach
4,612,230 A	9/1986	Liland et al.
4,999,235 A	3/1991	Lunn et al.
5,158,555 A	10/1992	Porzilli
5,188,124 A *	2/1993	Feret A61F 13/023 128/889

(72) Inventors: **Leonardo Caneppele**, Jacareí (BR);
Andre Narcizo, São José dos Campos (BR); **Paulo Cesar de Godoy Oriani**, Itatiba (BR); **Carmine Rizzo**, Port St. Lucie, FL (US); **Andre Luiz Santos**, São José dos Campos (BR)

(73) Assignee: **Johnson & Johnson Consumer Inc.,**
Skillman, NJ (US)

(**) Term: **15 Years**

(21) Appl. No.: **29/725,449**

(22) Filed: **Feb. 25, 2020**

Related U.S. Application Data

(62) Division of application No. 29/643,723, filed on Apr. 11, 2018, now Pat. No. Des. 880,705.

(51) **LOC (13) Cl.** **24-04**

(52) **U.S. Cl.**
USPC **D24/189**

(58) **Field of Classification Search**
USPC D24/112, 124–128, 132, 133, 185–193,
D24/199, 200, 206, 209, 210, 212–215;
D29/100, 101.1, 108, 120.1, 121.1, 121.2;
D30/146; D5/4, 46, 49, 53, 56, 58–62,
D5/99
CPC A61F 13/023; A61F 13/066; A61F 13/00;
A61F 13/00021; A61F 13/0206; A61F
13/0203; A61F 13/00025; A61F
13/00038; A61F 13/0243; A61F 13/0266;
A61M 1/0088

See application file for complete search history.

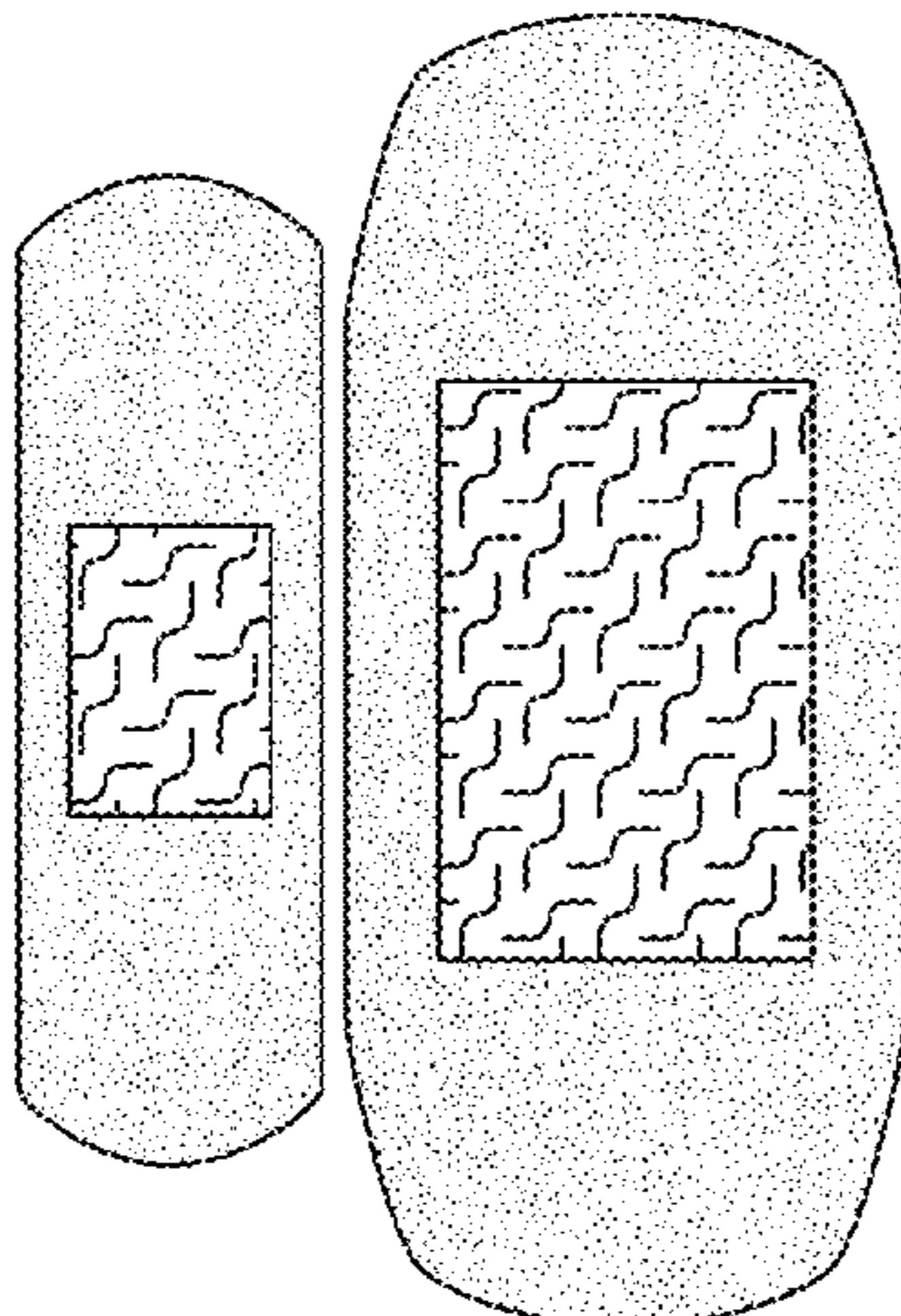

US D959,678 S

8,283,514 B2	10/2012	Baschnagel		D942,155 S	2/2022	McClain et al.
D672,154 S	12/2012	Huss et al.		D942,156 S	2/2022	McClain et al.
8,387,497 B2	3/2013	Raidel et al.		D942,759 S	2/2022	McClain et al.
D683,035 S	5/2013	Dunshee et al.		D943,749 S *	2/2022	Caneppele D24/189
D688,882 S	9/2013	Rhodes et al.		D943,750 S *	2/2022	Caneppele D24/189
D692,673 S	11/2013	Rhodes, III et al.		D943,751 S *	2/2022	Caneppele D24/189
D693,130 S	11/2013	Rhodes, III et al.		2002/0156410 A1 *	10/2002	Lawry A61F 13/0203 602/48
D694,892 S	12/2013	Chan et al.				
8,613,993 B2	12/2013	Kuchar		2004/0002676 A1	1/2004	Siegwart et al.
D696,869 S	1/2014	Rhodes, III et al.		2004/0049144 A1	3/2004	Cea
D697,216 S	1/2014	Chan et al.		2006/0057369 A1	3/2006	Hilfenhaus et al.
8,680,360 B2	3/2014	Greener et al.		2010/0016771 A1	1/2010	Arbesman et al.
D707,829 S	6/2014	Chan et al.		2010/0100022 A1	4/2010	Greener et al.
D708,751 S	7/2014	Chan et al.		2010/0179463 A1	7/2010	Greener et al.
D712,546 S	9/2014	Igwebuike et al.		2010/0210988 A1	8/2010	Dallison et al.
D714,560 S	10/2014	Xu et al.		2011/0092874 A1 *	4/2011	Basch A61F 13/022 602/54
D723,175 S	2/2015	Igwebuike et al.				
D728,803 S	5/2015	Sinda et al.		2012/0041402 A1	2/2012	Greener
D741,498 S	10/2015	Kawahara et al.		2012/0220973 A1	8/2012	Chan et al.
D745,688 S	12/2015	Chan et al.		2012/0220974 A1	8/2012	Chan et al.
D745,689 S	12/2015	Chan et al.		2012/0220975 A1	8/2012	Chan et al.
D745,690 S	12/2015	Devenish et al.		2013/0282049 A1	10/2013	Peterson et al.
D746,479 S	12/2015	Arefleg		2014/0094730 A1	4/2014	Greener et al.
D746,996 S	1/2016	Karlsson et al.		2016/0058998 A1	3/2016	Skiba et al.
D748,921 S	2/2016	Romano, III et al.		2017/0087027 A1 *	3/2017	Coffey A61L 15/26
D749,210 S	2/2016	Appelbaum et al.		2018/0289559 A1	10/2018	Caneppele et al.
9,308,115 B2	4/2016	Quinn		2019/0099297 A1	4/2019	Cettina et al.
D756,668 S	5/2016	Blythe et al.		2020/0246193 A1	8/2020	Wurapa
D757,950 S	5/2016	Karlsson et al.				
D765,993 S	9/2016	Palzewicz				
D770,631 S	11/2016	Green				
D773,194 S	12/2016	Hurley et al.				
9,511,215 B2	12/2016	Skiba				
D777,456 S	1/2017	Azeredo et al.				
9,533,809 B2	1/2017	Kuchar et al.				
D789,616 S	6/2017	Votel et al.				
D790,071 S	6/2017	Ahsani et al.				
9,820,888 B2	11/2017	Greener et al.				
D807,518 S	1/2018	Gildersleeve				
D823,608 S	7/2018	Stephani et al.				
D825,202 S	8/2018	Stephani et al.				
D840,026 S	2/2019	Candy				
10,219,953 B2	3/2019	Dewitt et al.				
D845,647 S	4/2019	Zhu et al.				
D848,004 S	5/2019	Del Rossi et al.				
10,299,966 B2	5/2019	Pigg				
D851,776 S	6/2019	Weinstein				
D851,944 S	6/2019	Toelke et al.				
D851,945 S	6/2019	Toelke et al.				
D851,946 S	6/2019	Toelke et al.				
D851,947 S	6/2019	Toelke et al.				
10,307,587 B2	6/2019	King et al.				
D852,512 S	7/2019	Toelke et al.				
D852,513 S	7/2019	Toelke et al.				
D852,514 S	7/2019	Toelke et al.				
D856,005 S	8/2019	Chaturvedi				
10,442,574 B2	10/2019	Kuchar et al.				
10,470,935 B2	11/2019	Quintero et al.				
D878,608 S	3/2020	Tapper et al.				
D879,972 S *	3/2020	Caneppele D24/189				
D879,973 S *	3/2020	Caneppele D24/189				
D879,974 S	3/2020	Caneppele et al.				
D879,975 S	3/2020	Caneppele et al.				
D880,705 S *	4/2020	Caneppele D24/189				
D887,563 S	6/2020	Caneppele et al.				
D887,564 S	6/2020	Caneppele et al.				
D890,352 S	7/2020	Dechow				
D895,813 S	9/2020	Hicken et al.				
D900,486 S *	11/2020	Steenblock D5/59				
D901,801 S	11/2020	Aragon et al.				
D904,624 S	12/2020	Del Rossi				
D911,537 S	2/2021	Weinstein				
D913,507 S *	3/2021	Caneppele D24/189				
D918,398 S	5/2021	Caneppele et al.				
D919,821 S	5/2021	Fosler et al.				
D923,801 S	6/2021	Lee				
D927,860 S	8/2021	Jacob et al.				
D931,472 S	9/2021	Toth et al.				
D936,845 S *	11/2021	Hahn D24/189				

FOREIGN PATENT DOCUMENTS

EP	136594 A	4/1985
EP	300815 A	1/1989
EP	3085344 A	10/2016
GB	821959 A	10/1959
JP	200687488 A	4/2006
WO	WO 2010/097570 A	9/2010
WO	WO 2016/030047 A	3/2014
WO	WO 2016/081708 A	5/2014
WO	WO 2014/149718 A	9/2014

OTHER PUBLICATIONS

Amazon. Band-Aid Brand SKINFLEX Adhesive Bandages for First Aid and Wound Care All One Size ct, 25 Count. Jan. 30, 2017. <https://www.amazon.com/Band-Aid-Brand-Skin-Flex-Adhesive-Bandages/dp/B01M1K2MC0> (Year: 2017).*

Amazon. Band-Aid Brand Adhesive Bandage Family Variety Pack, Sheer and Clear Bandages, Assorted Sizes, 280 ct. Jun. 23, 2006. <https://amzn.to/3vfLw3h> (Year: 2006).*

U.S. Appl. No. 29/643,723, filed Apr. 11, 2018, Pending, J&J Consumer Inc.

U.S. Appl. No. 29/643,725, filed Apr. 11, 2018, Pending, J&J Consumer Inc.

U.S. Appl. No. 29/643,727, filed Apr. 11, 2018, Pending, J&J Consumer Inc.

U.S. Appl. No. 15/950,319, filed Apr. 11, 2018, US20180289551A1, Pending, J&J Consumer Inc.

U.S. Appl. No. 15/950,326, filed Apr. 11, 2018, US20180289559A1, Pending, J&J Consumer Inc.

U.S. Appl. No. 15/950,341, filed Apr. 11, 2018, US20180289552A1, Pending, J&J Consumer Inc.

U.S. Appl. No. 15/950,346, filed Apr. 11, 2018, US20180289553A1, Pending, J&J Consumer Inc.

U.S. Appl. No. 15/950,355, filed Apr. 11, 2018, US20180289554A1, Pending, J&J Consumer Inc.

U.S. Appl. No. 62/483,989, filed Apr. 11, 2017, Expired, J&J Consumer Inc.

U.S. Appl. No. 29/654,725, filed Jun. 27, 2018, Pending, J&J Consumer Inc.

U.S. Appl. No. 29/654,726, filed Jun. 27, 2018, Pending, J&J Consumer Inc.

U.S. Appl. No. 29/654,728, filed Jun. 27, 2018, Pending, J&J Consumer Inc.

U.S. Appl. No. 29/654,731, filed Jun. 27, 2018, Pending, J&J Consumer Inc.

U.S. Appl. No. 29/672,805, filed Dec. 10, 2018, Pending, J&J Consumer Inc.

U.S. Appl. No. 29/672,807, filed Dec. 10, 2018, Pending, J&J Consumer Inc.

Amazon. Band-Aid Brand Tru-Stay Sheer Strips Adhesive Bandages for First Aid Review by “k1dpr”. Mar. 7, 2017. https://www.amazon.com/dp/B0009STDOW/ref=psdc_3762721_t4_B00B6A6Y9E (Year 2017).

“‘Band-Aid’ wound power pad for elbow and knee protection”, published in “‘Protection series’, new for ‘Band-Aid’ would power pad, effectively protecting shallow and broad wound”, dated Mar. 16, 2010, stored in and published from Internet Archive, run by the US non-profit corporation Internet Archive (output date: May 12, 2014). Internet Archive URL: <https://web.archive.org/web/20100316073304/http://www.jnj.co.jp/group/press/2009/0309/index.html>.

Democrat and Chronicle. Old-school Snake game is making a comeback by WUSA 9 Staff. May 7, 2015. <https://www.democratandchronicle.com/story/news/local/2015/05/07/snake-game-makes-comeback/70938102/> (Year 2015).

Douglas Flynt. Accurate Ellipses. Aug. 8, 2011; Oct. 11, 2011. <http://douglasflynt.blogspot.com/2011/08/accurate-ellipses.html> (Year 2011).

IStock Photo. Seamless pattern with zigzag and triple X shaped line segments stock illustration. Jul. 2, 2018. <https://www.istockphoto.com/vector/seamless-pattern-with-zigzag-and-triple-x-shaped-line-segments-gm990118502-268386144> (Year 2018).

Nancy Cartwright. Nancy Cartwright Takes Over as “Chuckie” on The Rugrats. Jul. 2, 2002. <https://nancycartwright.com/news/nancy-takes-over-as-chuckie-on-the-rugrats/> (Year 2002).

The Next Plate. Creative Cake Cutting idea. Oct. 27, 2010. <https://thenextplate.tumblr.com/> (Year 2010).

Miller Pads and paper. Graph Paper Pad. No date specified. <http://millerpadsandpaper.com/graph-paper-pad/> (Year 0).

Shutterstock. Abstract black geometric background. Dots and line. By Djem. No date specified, <https://www.shutterstock.com/image-vector/abstract-black-geometric-background-dots-line-232331239> (Year 0).

Target. Band-Aid Oh Joy! Adhesive Bandages—20 ct. No date specified. <https://www.target.com/p/band-aid-oh-joy-adhesive-bandages-20ct/-/A-17221637> (Year 0).

Devine Express. Guardian Advantage Series Butterfly Electrodes Butterfly Tape Patch, Mini-Snap, 0.875" cs/50-32840. No date specified. <https://bit.ly/3l4Bijc> (Year: 0).

Amazon, Band-Aid Brand Flexible Fabric Adhesive Bandages for Wound Care and First Aid, Finger and Knuckle, 20 ct (Pack of 6), Sep. 9, 2006, <https://www.amazon.com/Band-Aid-Flexible-Adhesive-Bandages-Knuckle/dp/B000061DL7> (Year 2006).

* cited by examiner

Primary Examiner — Darcey E Gottschalk

(57) **CLAIM**

We claim the ornamental design for an adhesive bandage with decorated pad, as shown and described.

DESCRIPTION

FIG. 1 is a top perspective view of the present invention; FIG. 2 is a top view of the adhesive bandage with decorated pad depicted in FIG. 1;

FIG. 3 is a left side view of the adhesive bandage with decorated pad depicted in FIG. 1;

FIG. 4 is a bottom view of the adhesive bandage with decorated pad depicted in FIG. 1;

FIG. 5 is a right side view of the adhesive bandage with decorated pad depicted in FIG. 1;

FIG. 6 is a front side view of the adhesive bandage with decorated pad depicted in FIG. 1;

FIG. 7 is a back side view of the adhesive bandage with decorated pad depicted in FIG. 1;

FIG. 8 is a top perspective view of a second embodiment of the present invention;

FIG. 9 is a top view of the adhesive bandage with decorated pad depicted in FIG. 8;

FIG. 10 is a left side view of the adhesive bandage with decorated pad depicted in FIG. 8;

FIG. 11 is a bottom view of the adhesive bandage with decorated pad depicted in FIG. 8;

FIG. 12 is a right side view of the adhesive bandage with decorated pad depicted in FIG. 8;

FIG. 13 is a front side view of the adhesive bandage with decorated pad depicted in FIG. 8;

FIG. 14 is a back side view of the adhesive bandage with decorated pad depicted in FIG. 8;

FIG. 15 is a top perspective view of a third embodiment of the present invention;

FIG. 16 is a top view of the adhesive bandage with decorated pad depicted in FIG. 15;

FIG. 17 is a left side view of the adhesive bandage with decorated pad depicted in FIG. 15;

FIG. 18 is a bottom view of the adhesive bandage with decorated pad depicted in FIG. 15;

FIG. 19 is a right side view of the adhesive bandage with decorated pad depicted in FIG. 15;

FIG. 20 is a front side view of the adhesive bandage with decorated pad depicted in FIG. 15;

FIG. 21 is a back side view of the adhesive bandage with decorated pad depicted in FIG. 15;

FIG. 22 is a top perspective view of a fourth embodiment of the present invention;

FIG. 23 is a top view of the adhesive bandage with decorated pad depicted in FIG. 22;

FIG. 24 is a left side view of the adhesive bandage with decorated pad depicted in FIG. 22;

FIG. 25 is a bottom view of the adhesive bandage with decorated pad depicted in FIG. 22;

FIG. 26 is a right side view of the adhesive bandage with decorated pad depicted in FIG. 22;

FIG. 27 is a front side view of the adhesive bandage with decorated pad depicted in FIG. 22;

FIG. 28 is a back side view of the adhesive bandage with decorated pad depicted in FIG. 22;

FIG. 29 is a top perspective view of a fifth embodiment of the present invention;

FIG. 30 is a top view of the adhesive bandage with decorated pad depicted in FIG. 29;

FIG. 31 is a left side view of the adhesive bandage with decorated pad depicted in FIG. 29;

FIG. 32 is a bottom view of the adhesive bandage with decorated pad depicted in FIG. 29;

FIG. 33 is a right side view of the adhesive bandage with decorated pad depicted in FIG. 29;

FIG. 34 is a front side view of the adhesive bandage with decorated pad depicted in FIG. 29;

FIG. 35 is a back side view of the adhesive bandage with decorated pad depicted in FIG. 29;

FIG. 36 is a top perspective view of a sixth embodiment of the present invention;

FIG. 37 is a top view of the adhesive bandage with decorated pad depicted in FIG. 50;

FIG. **38** is a left side view of the adhesive bandage with decorated pad depicted in FIG. **37**;

FIG. **39** is a bottom view of the adhesive bandage with decorated pad depicted in FIG. **38**;

FIG. **40** is a right side view of the adhesive bandage with decorated pad depicted in FIG. **39**;

FIG. **41** is a front side view of the adhesive bandage with decorated pad depicted in FIG. **40**; and,

FIG. **42** is a back side view of the adhesive bandage with decorated pad depicted in FIG. **41**.

1 Claim, 7 Drawing Sheets

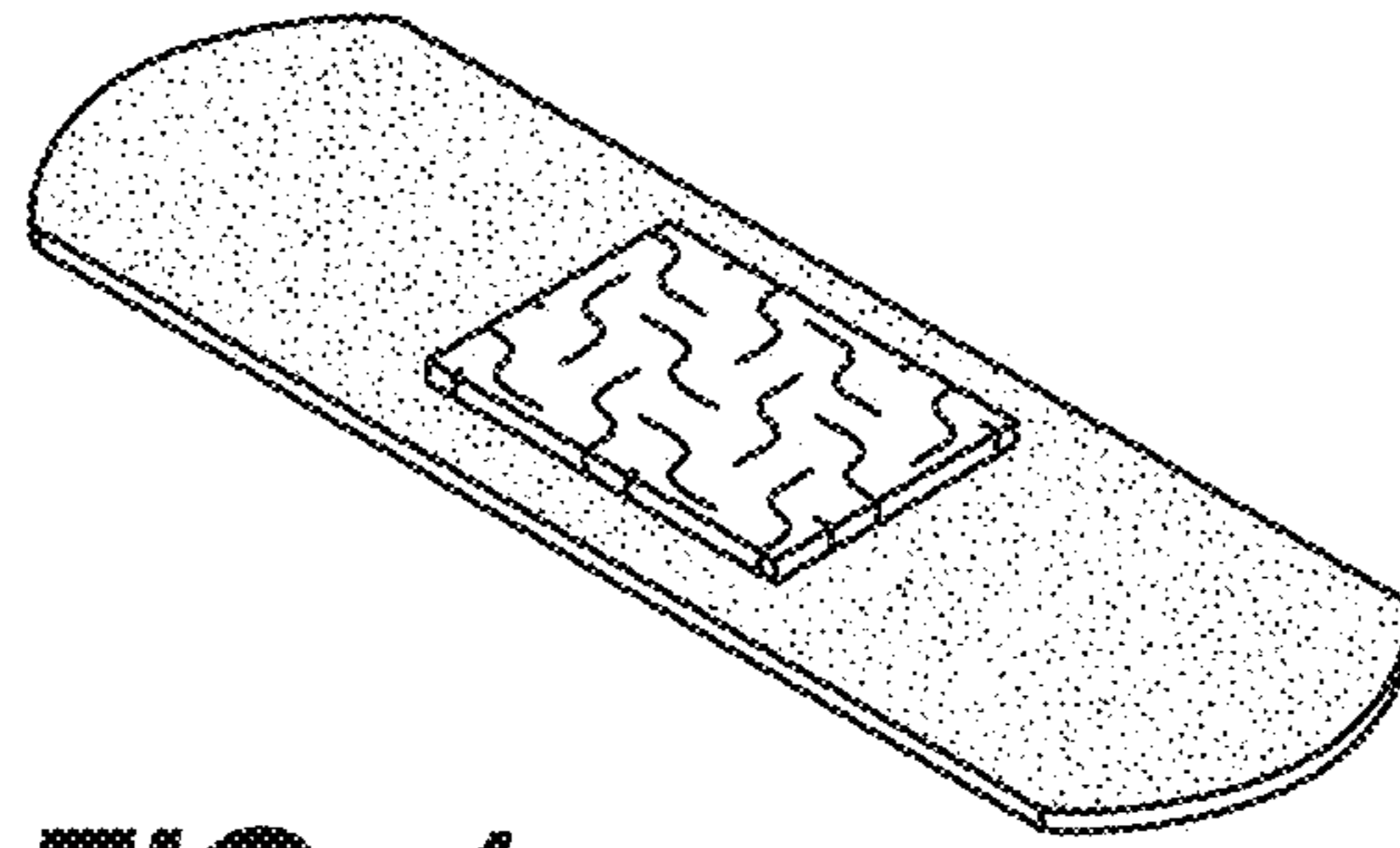

FIG. 1

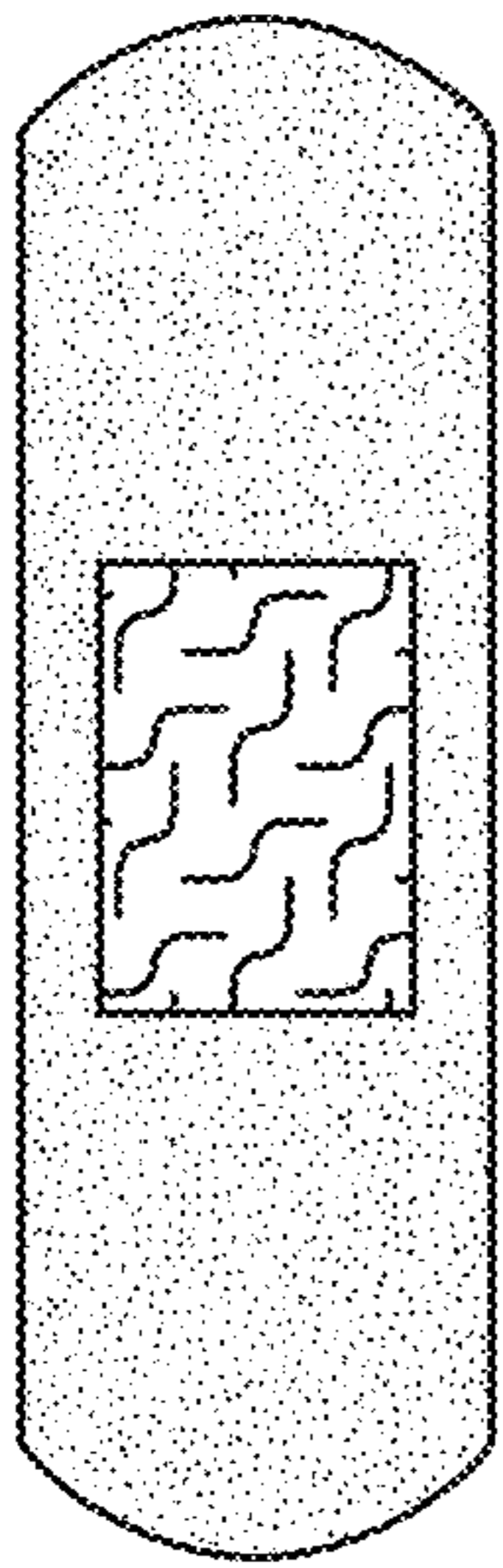

FIG. 2



FIG. 3

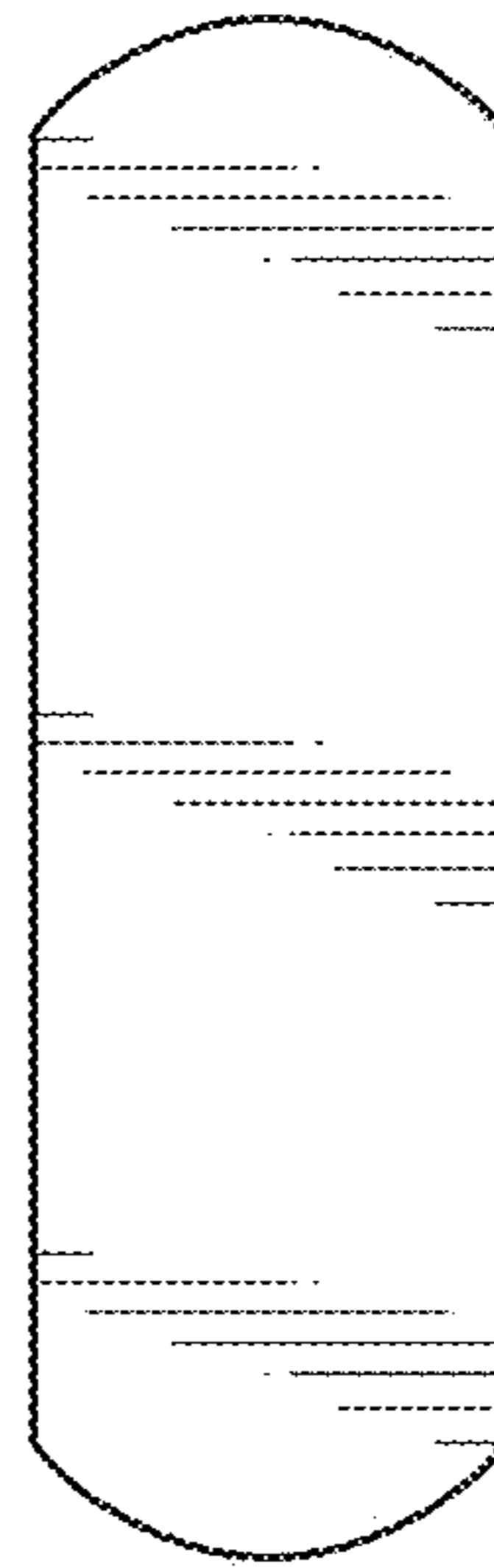

FIG. 4



FIG. 5

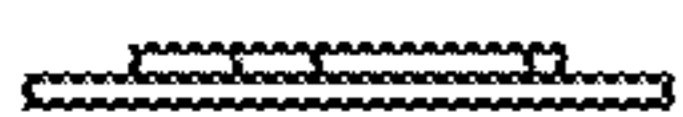

FIG. 6



FIG. 7

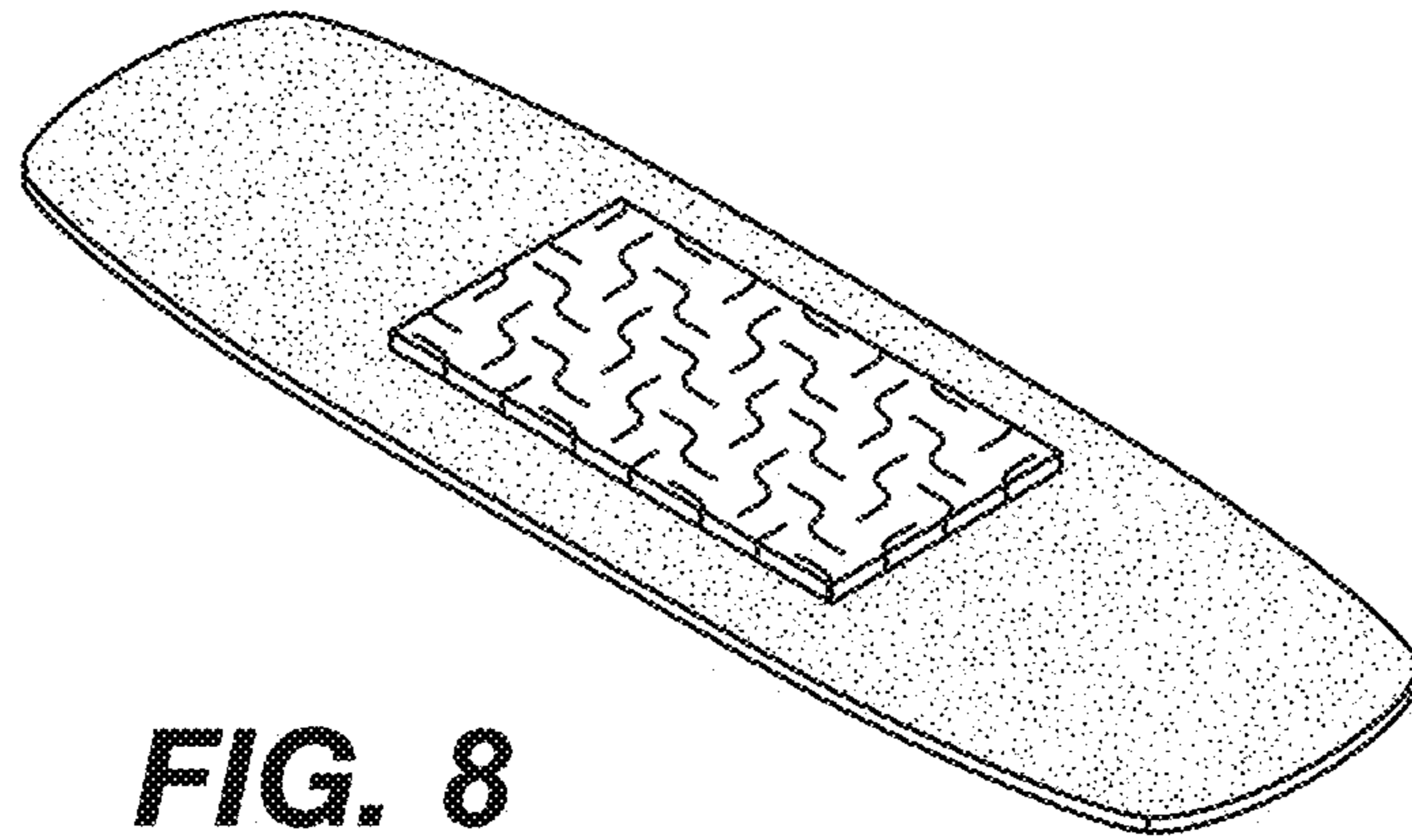

FIG. 8

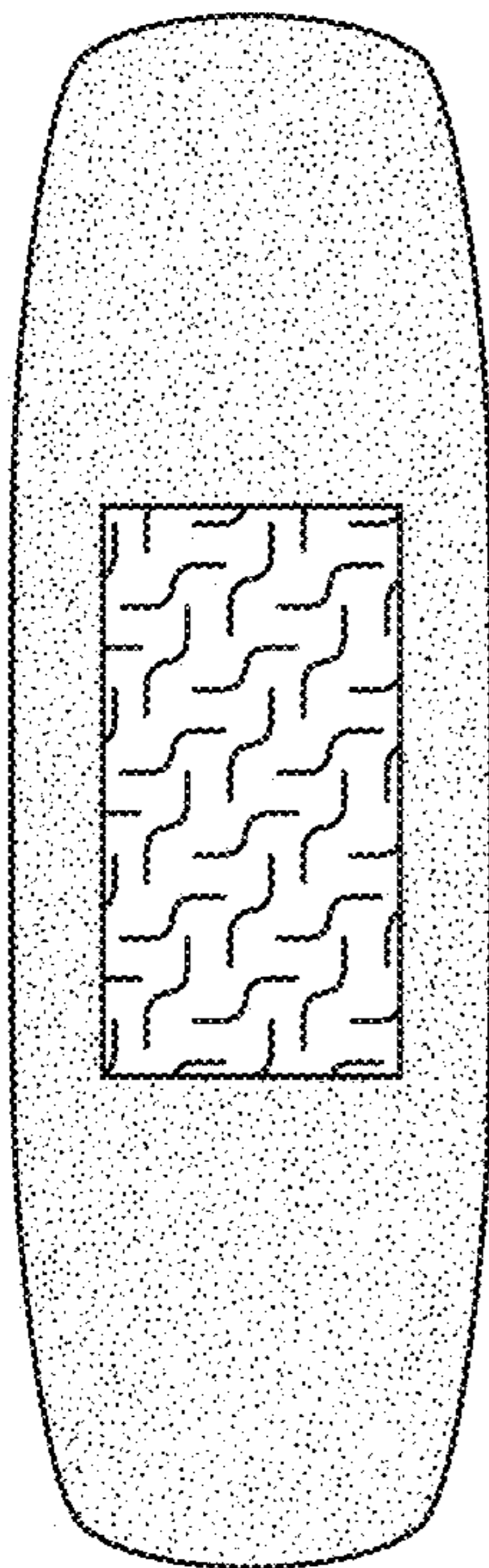

FIG. 9



FIG. 10

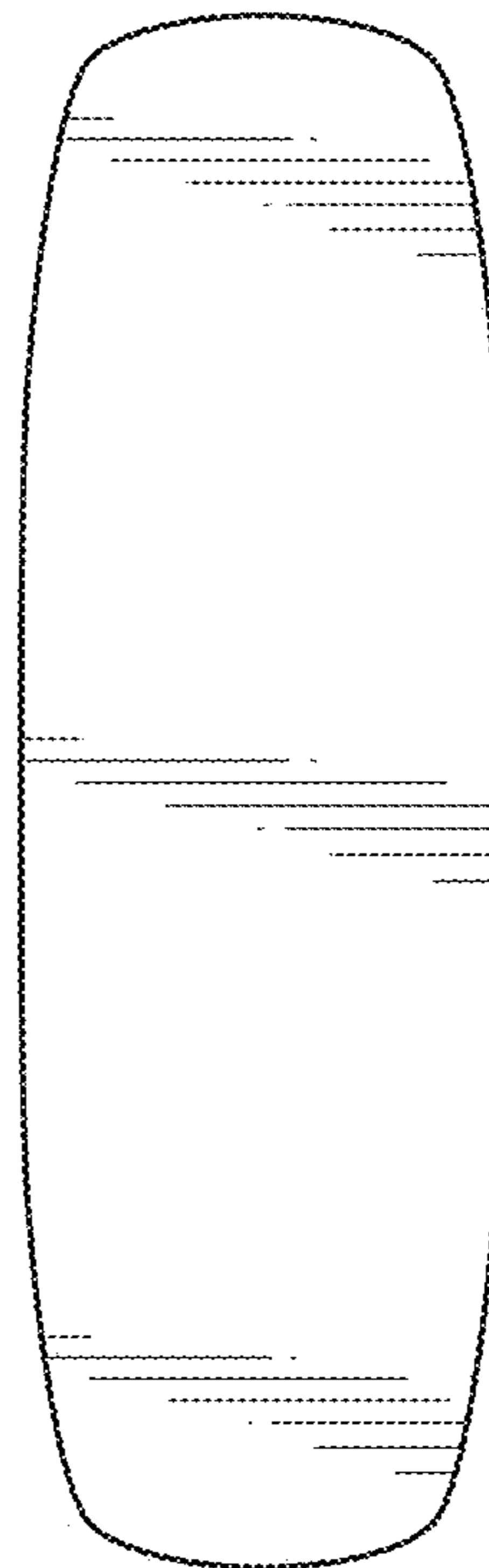

FIG. 11



FIG. 12

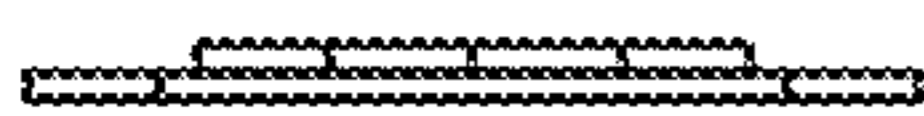

FIG. 13

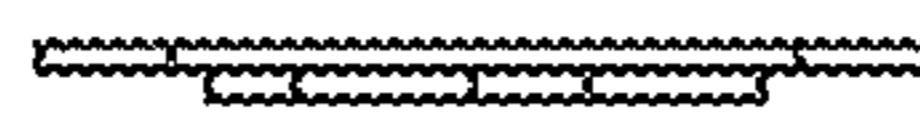

FIG. 14

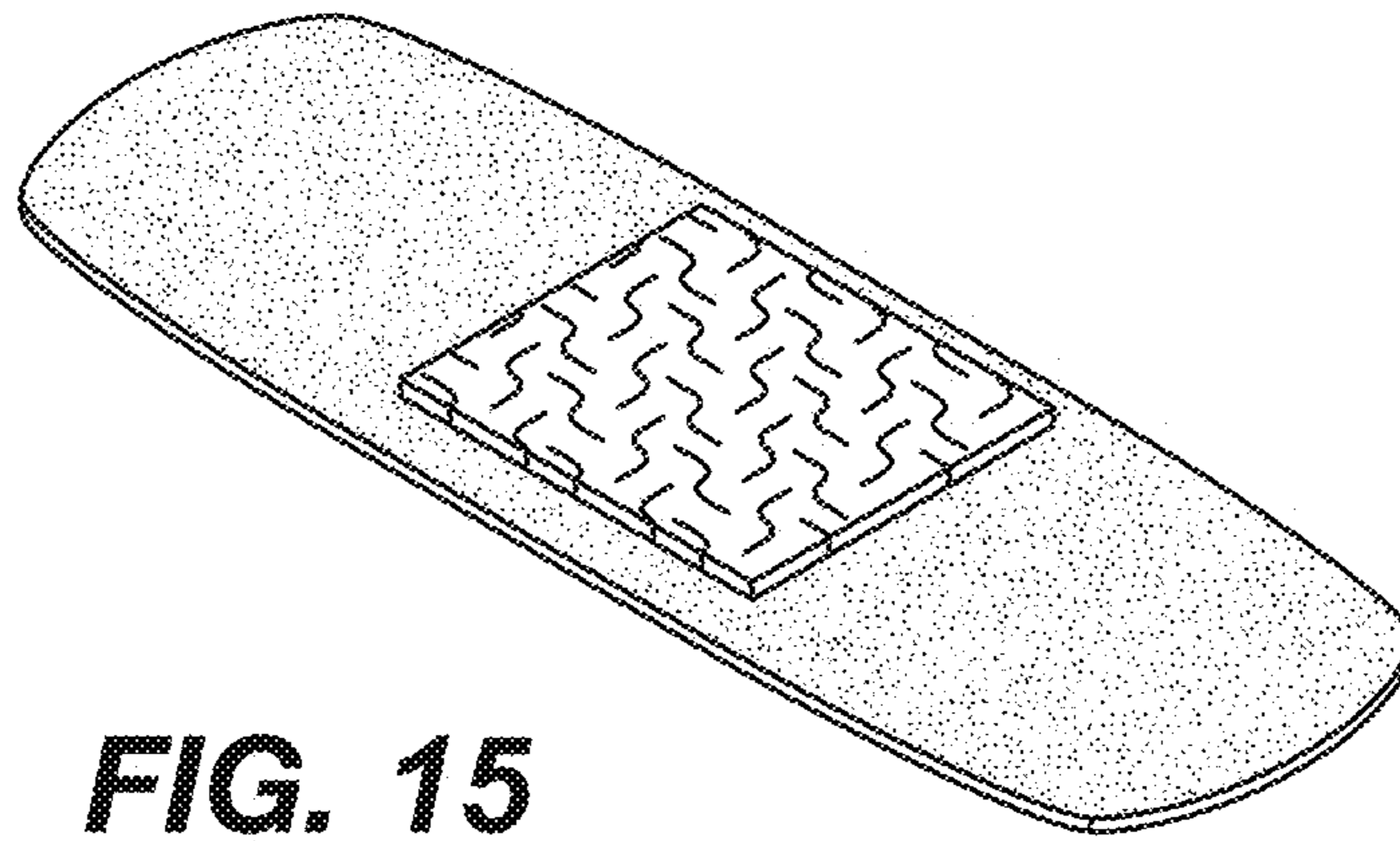

FIG. 15

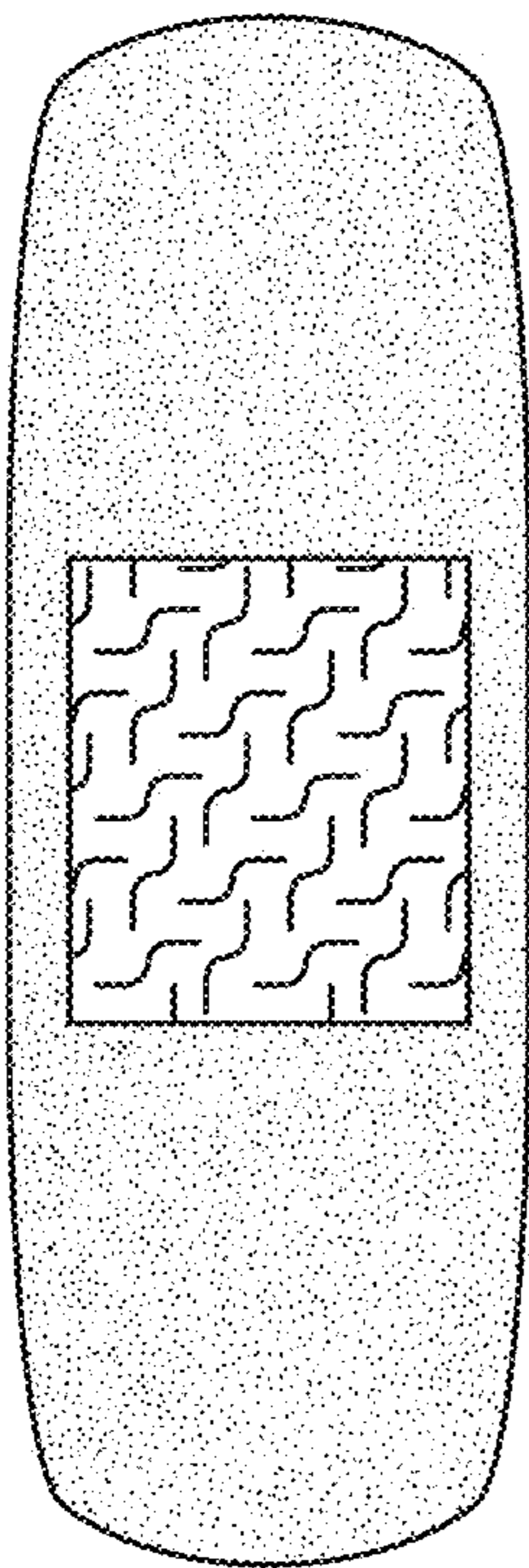

FIG. 16



FIG. 17

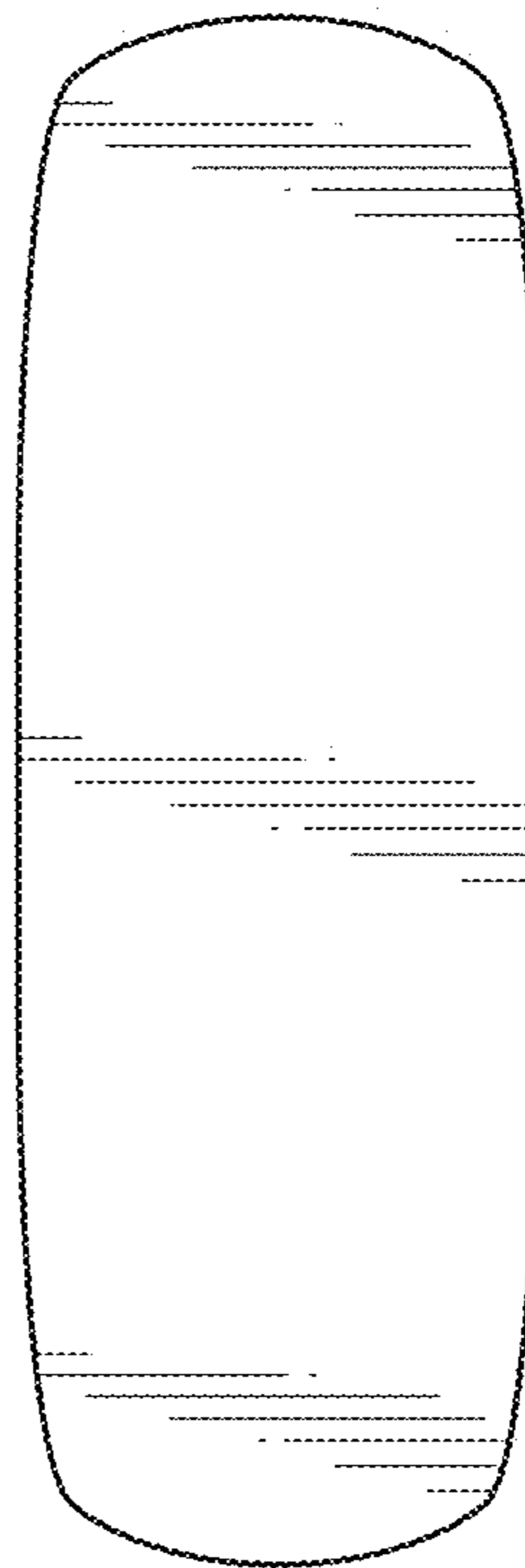

FIG. 18



FIG. 19

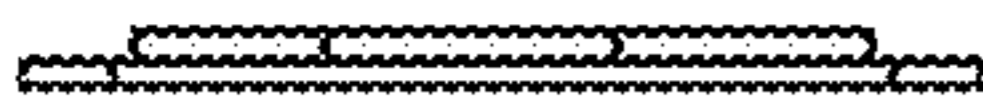

FIG. 20

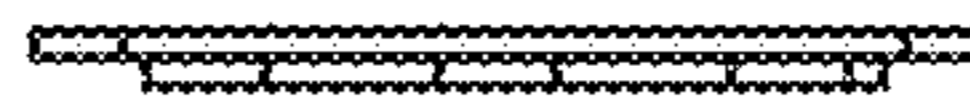

FIG. 21

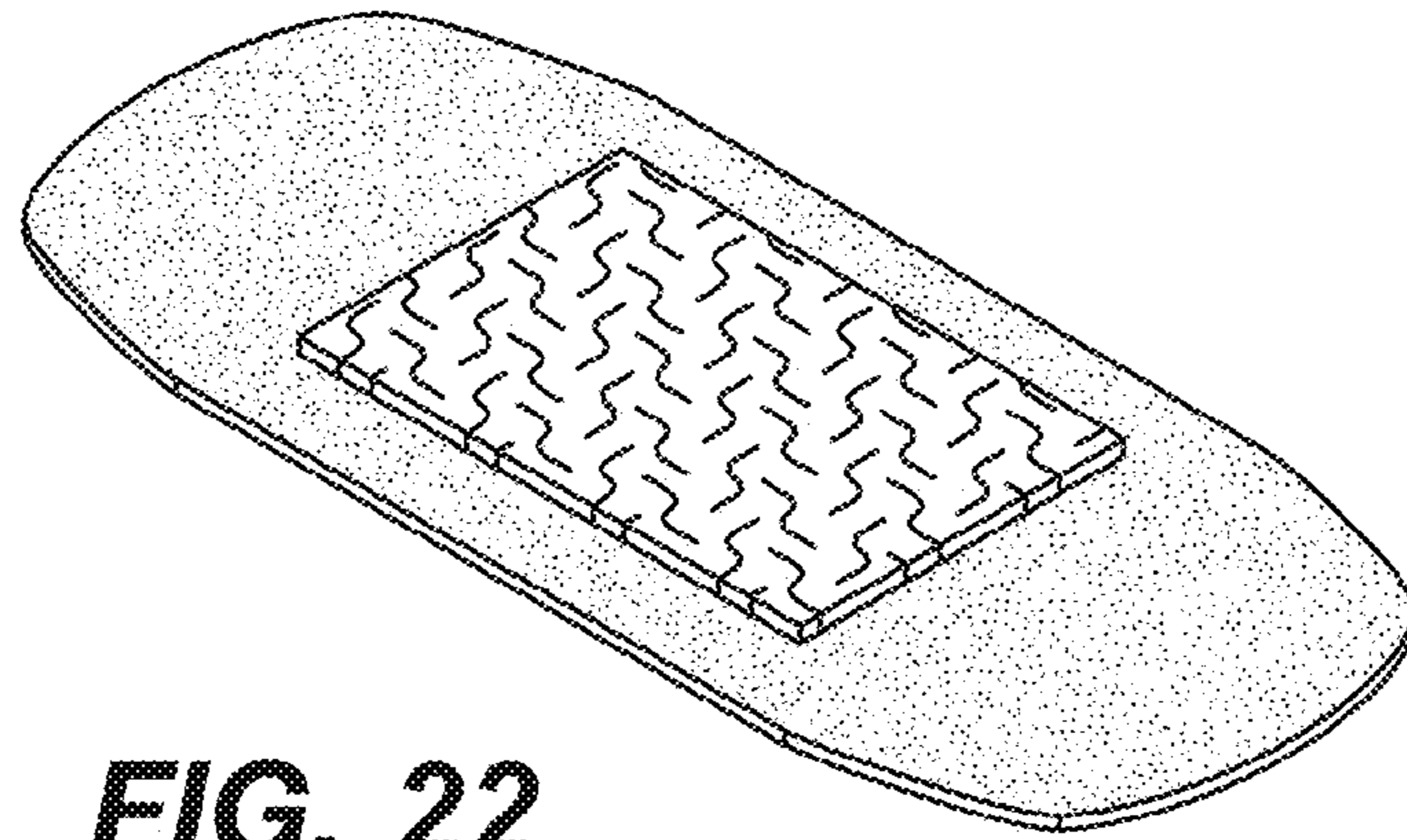

FIG. 22

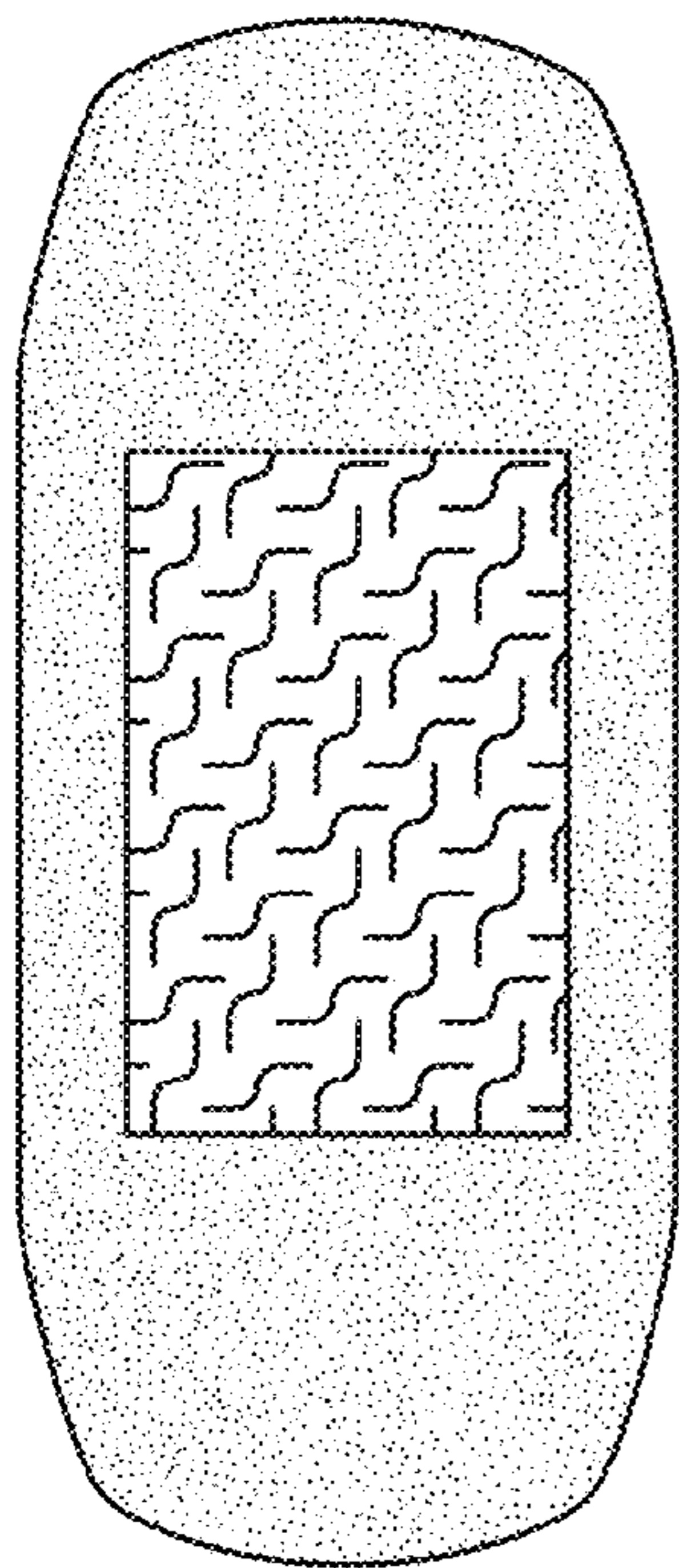

FIG. 23



FIG. 24

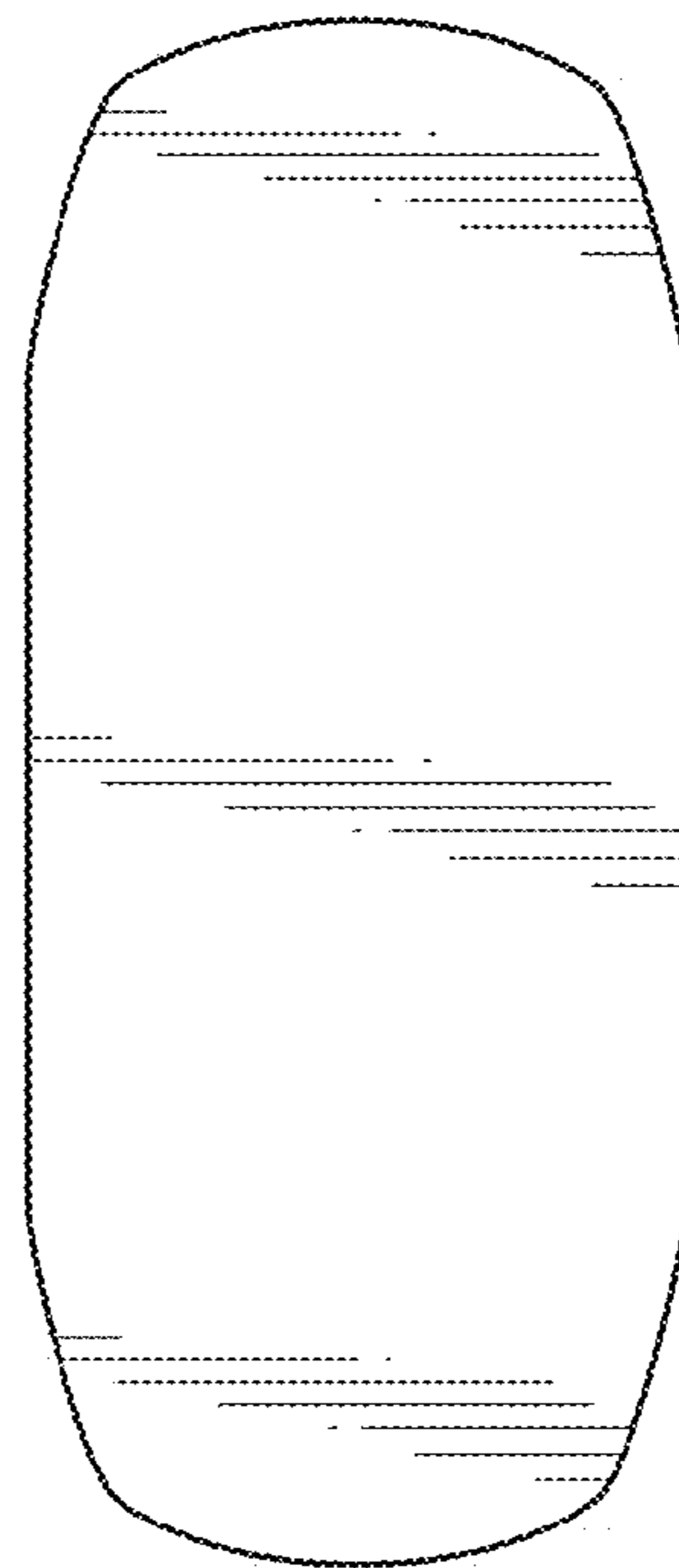

FIG. 25



FIG. 26

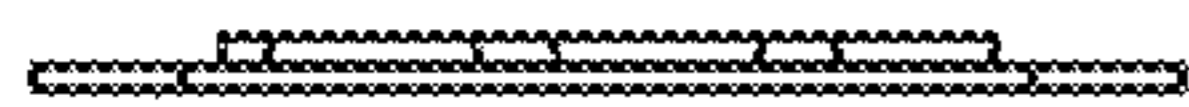

FIG. 27

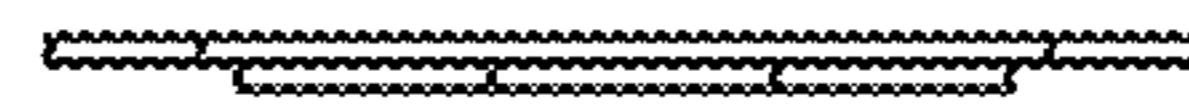

FIG. 28

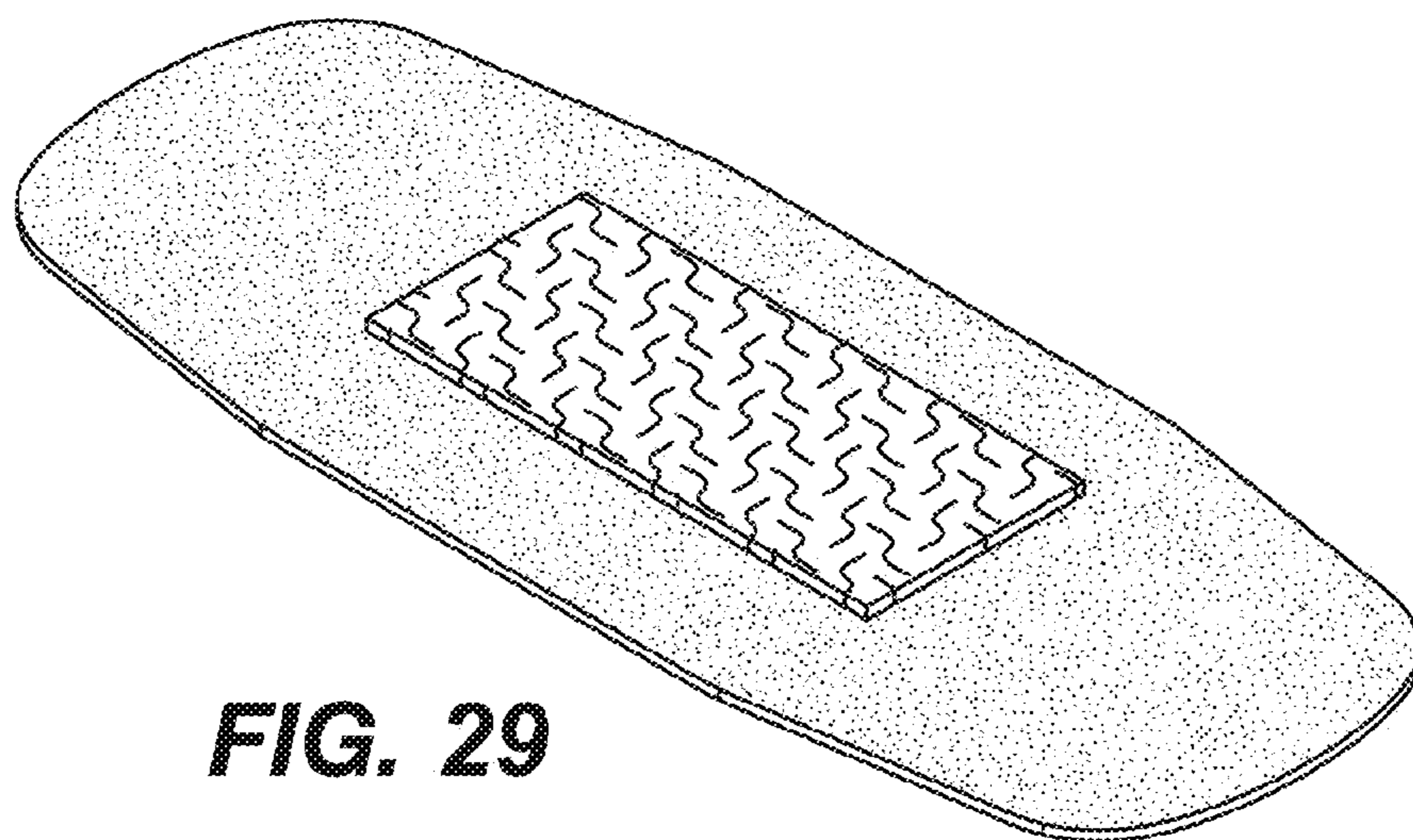

FIG. 29

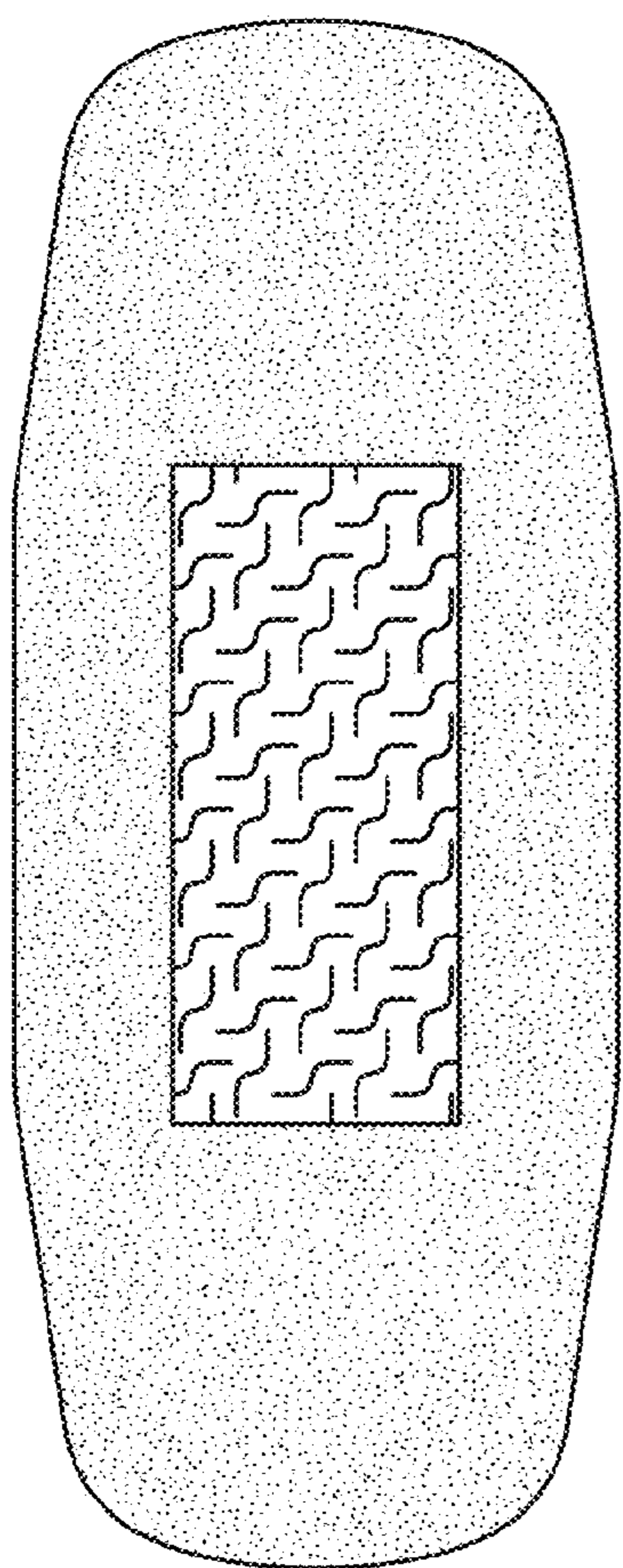

FIG. 30



FIG. 31

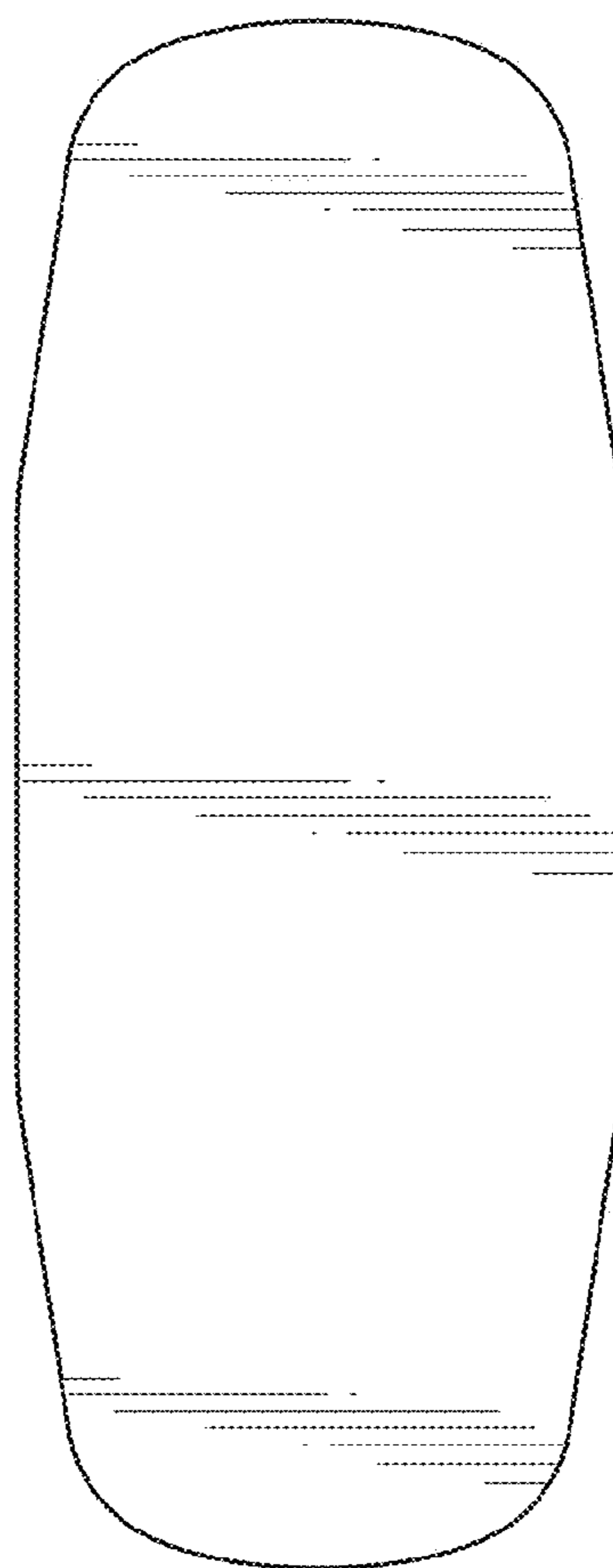

FIG. 32



FIG. 33

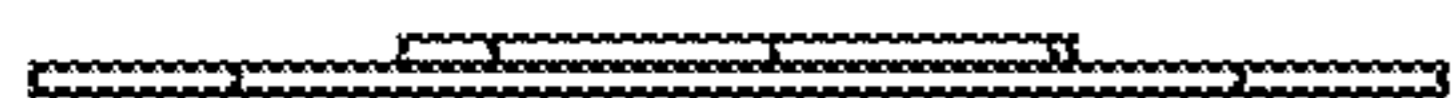

FIG. 34



FIG. 35

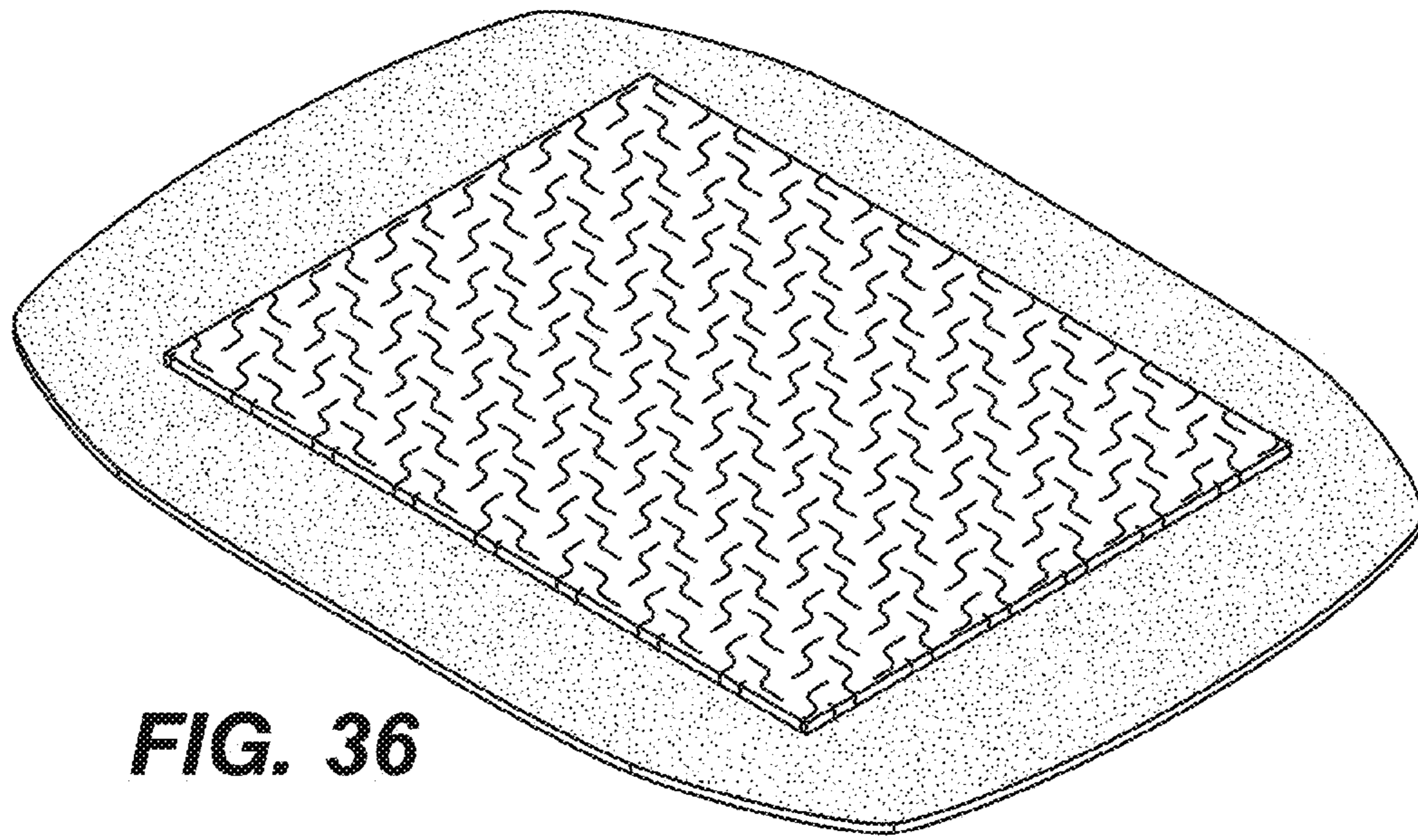

FIG. 36

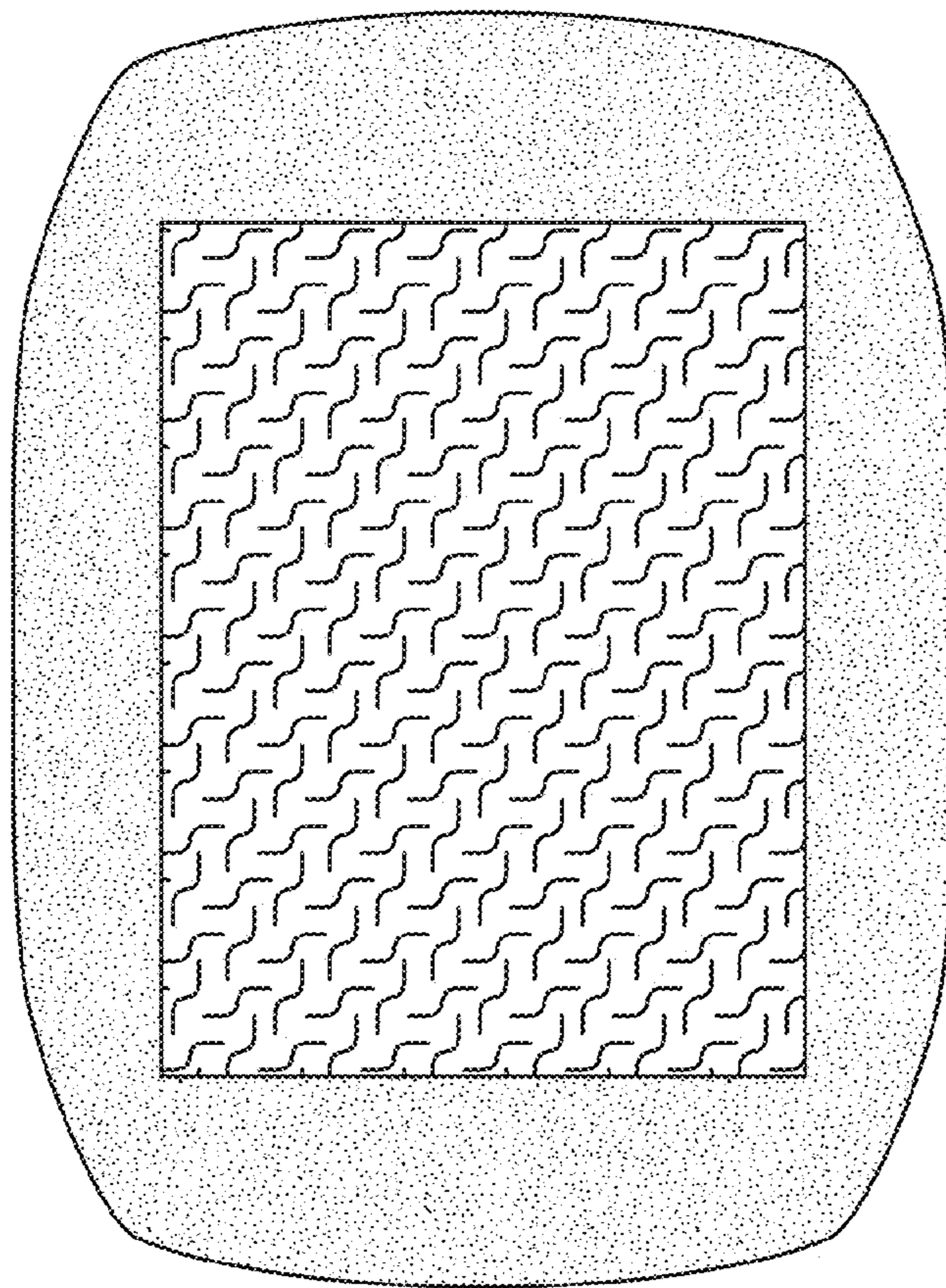

FIG. 37



FIG. 38

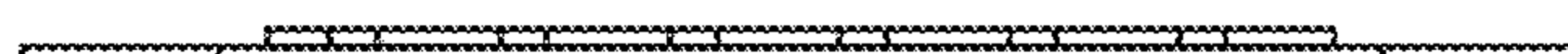

FIG. 41

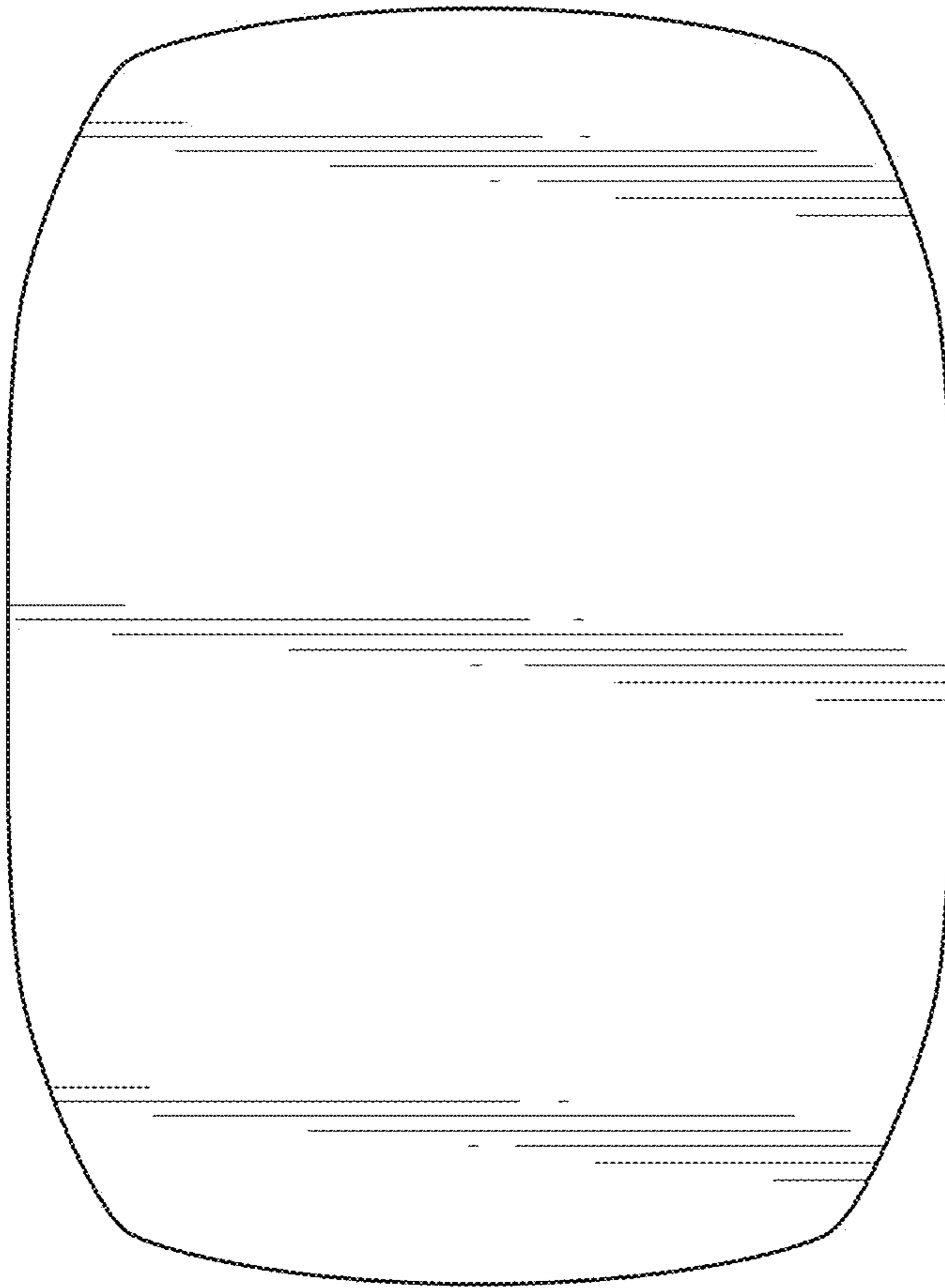

FIG. 39



FIG. 40

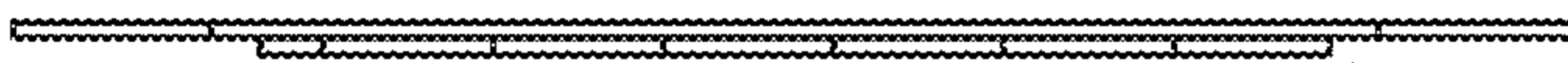

FIG. 42