



US00D959581S

(12) **United States Design Patent**
Parsons et al.

(10) **Patent No.:** **US D959,581 S**
(45) **Date of Patent:** **** Aug. 2, 2022**

(54) **GOLF CLUB HEAD**

- (71) Applicant: **PARSONS XTREME GOLF, LLC**,
Scottsdale, AZ (US)
- (72) Inventors: **Robert R. Parsons**, Scottsdale, AZ
(US); **Matthew T. Andrews**, Scottsdale,
AZ (US)
- (73) Assignee: **PARSONS XTREME GOLF, LLC**,
Scottsdale, AZ (US)
- (**) Term: **15 Years**
- (21) Appl. No.: **29/813,627**
- (22) Filed: **Oct. 29, 2021**

Related U.S. Application Data

- (60) Continuation-in-part of application No. 29/778,628,
filed on Apr. 14, 2021, which is a division of
application No. 29/763,585, filed on Dec. 23, 2020,
now Pat. No. Des. 919,722, which is a
continuation-in-part of application No. 29/760,203,
(Continued)
- (51) **LOC (13) Cl.** **21-02**
- (52) **U.S. Cl.**
USPC **D21/736**
- (58) **Field of Classification Search**
USPC D21/736-746, 759
CPC A63B 53/00; A63B 53/04; A63B 53/007;
A63B 53/065; A63B 53/0487; A63B
60/00; A63B 60/46
See application file for complete search history.

(56) **References Cited**

U.S. PATENT DOCUMENTS

- 723,534 A 3/1903 Knight
- 922,444 A 5/1909 Youds
- (Continued)

FOREIGN PATENT DOCUMENTS

- JP 2004223184 A 8/2004
- JP 2005160691 A 6/2005
- (Continued)

OTHER PUBLICATIONS

Plugged In Golf (2015 Bettinardi Putters Review) [online]. Mar. 3, 2015 [retrieve Nov. 25, 2019] Retrieve from the internet: URL: <https://pluggedingolf.com/2015-bettinardi-putters-review/>.

(Continued)

Primary Examiner — Mitchell I. Siegel

(57) **CLAIM**

The ornamental design for a golf club head, as shown and described.

DESCRIPTION

The patent or application file contains drawings executed in color. Copies of this patent or patent application publication with color drawings will be provided by the Office upon request and payment of the necessary fee.

FIG. 1 is a top perspective view of a golf club head;
FIG. 2 is a bottom perspective view of the golf club head of FIG. 1;
FIG. 3 is a front elevational view of the golf club head of FIG. 1;
FIG. 4 is a rear elevational view of the golf club head of FIG. 1;
FIG. 5 is a top view of the golf club head of FIG. 1;
FIG. 6 is a bottom view of the golf club head of FIG. 1;
FIG. 7 is a left side view of the golf club head of FIG. 1; and,
FIG. 8 is a right side view of the golf club head of FIG. 1.
The broken lines shown on the drawings form no part of the claimed design. The dash-dotted lines are included as boundary lines and form no part of the claimed design.

1 Claim, 4 Drawing Sheets
(2 of 4 Drawing Sheet(s) Filed in Color)

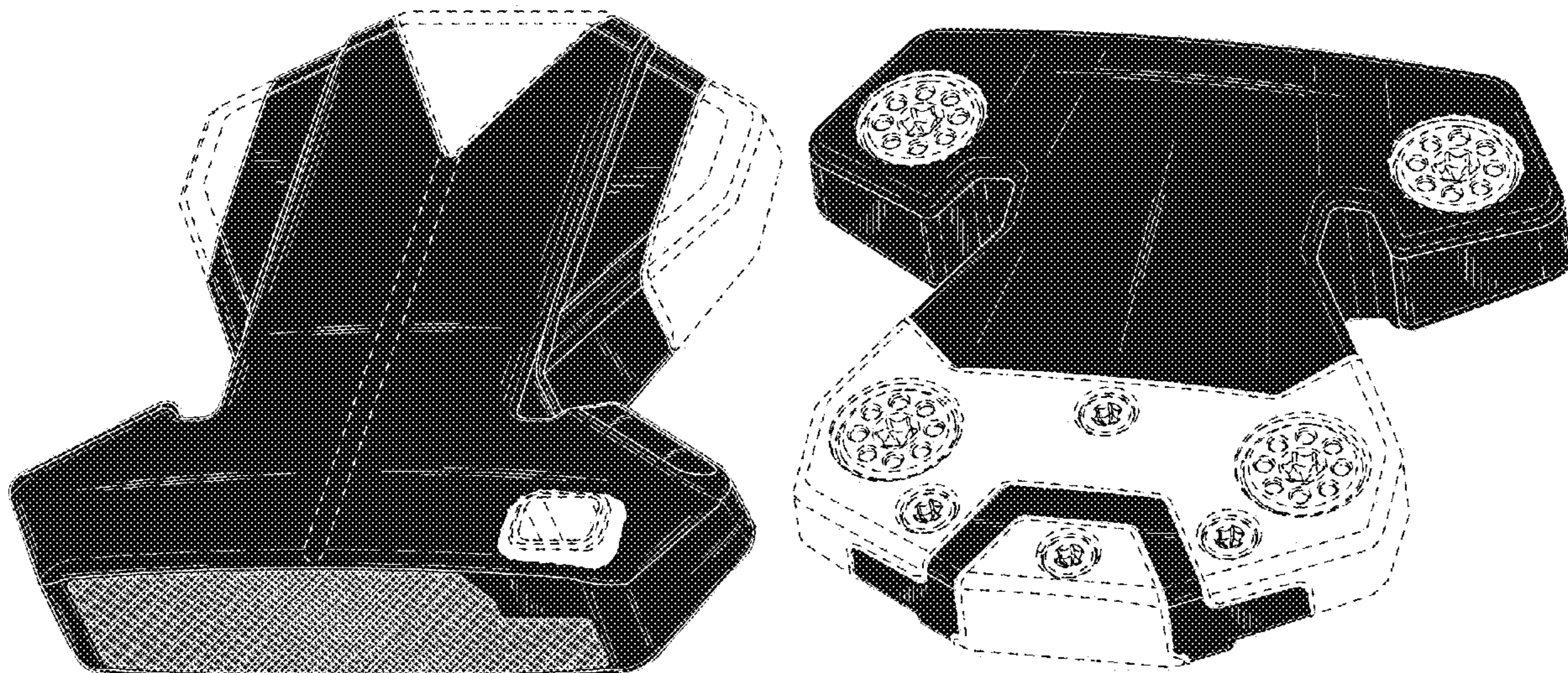

Related U.S. Application Data

filed on Nov. 30, 2020, which is a continuation-in-part of application No. 29/755,703, filed on Oct. 22, 2020, which is a continuation-in-part of application No. 29/748,024, filed on Aug. 26, 2020, now abandoned.

(56)

References Cited

U.S. PATENT DOCUMENTS

1,094,599 A	4/1914	Samson	6,257,994 B1	7/2001	Antonious
D57,980 S	5/1921	Kraeuter	6,264,571 B1	7/2001	Lekavich
D63,284 S	11/1923	Challis	D449,664 S	10/2001	Beebe
RE19,178 E	5/1934	Spiker	D449,865 S	10/2001	Fife, Jr. et al.
3,608,590 A	9/1971	Hohener et al.	D450,799 S	11/2001	Nicolette et al.
4,043,562 A	8/1977	Shillington	D451,973 S	12/2001	Wells et al.
D248,783 S	8/1978	Long	6,348,014 B1	2/2002	Chiu
4,340,230 A	7/1982	Churchward	6,354,959 B1	3/2002	Nicolette et al.
D281,092 S	10/1985	Mills	6,394,910 B1	5/2002	McCarthy
4,754,977 A	7/1988	Sahm	D472,949 S	4/2003	Serrano
4,869,507 A	9/1989	Sahm	D474,821 S	5/2003	Wells et al.
4,964,641 A	10/1990	Miesch et al.	D474,949 S	5/2003	Schaffeld et al.
D313,451 S	1/1991	Shearer	D482,087 S	11/2003	Burrows
D335,317 S	5/1993	Shearer	6,652,390 B2	11/2003	Bradford
D335,692 S	5/1993	Antonious	D483,086 S	12/2003	Schweigert et al.
D336,757 S	6/1993	Antonious	D486,539 S	2/2004	Burrows
5,275,412 A	1/1994	Innes	D486,872 S	2/2004	Schweigert et al.
D350,582 S	9/1994	Miansian et al.	D488,200 S	4/2004	Olsavsky et al.
5,390,919 A	2/1995	Stubbs et al.	D490,487 S	5/2004	Burrows
D356,131 S	3/1995	Trimble	D498,276 S	11/2004	Schweigert et al.
D360,444 S	7/1995	Takahashi et al.	D500,823 S	1/2005	Aldrich
5,429,366 A	7/1995	McCabe	D502,518 S	3/2005	Smart
D363,101 S	10/1995	Sturm	6,902,496 B2	6/2005	Solheim et al.
D364,665 S	11/1995	Goodrich	6,902,498 B2	6/2005	Sullivan et al.
D365,864 S	1/1996	Sturm	D509,273 S	9/2005	Morris et al.
5,489,097 A	2/1996	Simmons	D511,801 S	11/2005	Garcia
D368,751 S	4/1996	Rife	D512,114 S	11/2005	Garcia
D369,393 S	4/1996	Takahashi et al.	D512,116 S	11/2005	Miraflor et al.
5,571,053 A	11/1996	Lane	6,988,955 B2	1/2006	Stoakes
D378,688 S	4/1997	Cameron	6,988,956 B2	1/2006	Cover et al.
D380,514 S	7/1997	Markley	D520,088 S	5/2006	Parr
D385,609 S	10/1997	Cameron	D529,109 S	9/2006	Jones
5,683,307 A	11/1997	Rife	D531,242 S	10/2006	Adams
D388,143 S	12/1997	Huan-Chiang	7,125,341 B1	10/2006	D'Eath
D389,207 S	1/1998	Cameron	D532,067 S	11/2006	Soracco et al.
D398,685 S	9/1998	Masuda	7,153,220 B2	12/2006	Lo
5,807,190 A	9/1998	Krumme et al.	D534,595 S	1/2007	Hasebe
D399,290 S	10/1998	Sizemore, Jr.	7,156,752 B1	1/2007	Bennett
D399,911 S	10/1998	Nicolette et al.	D536,401 S	2/2007	Kawami
5,839,974 A	11/1998	McAllister	D536,403 S	2/2007	Kawami
D405,836 S	2/1999	Nicolette et al.	D537,898 S	3/2007	Kuan et al.
D409,701 S	5/1999	Ashcraft et al.	D538,371 S	3/2007	Kawami
D411,275 S	6/1999	Bottema et al.	7,204,765 B2	4/2007	Cover et al.
5,924,938 A	7/1999	Hines	D542,869 S	5/2007	Adams
D415,809 S	10/1999	Bottema et al.	D543,598 S	5/2007	Kuan et al.
D416,062 S	11/1999	Solheim et al.	D543,601 S	5/2007	Kawami
D416,969 S	11/1999	Solheim et al.	D555,219 S	11/2007	Lin
D416,970 S	11/1999	Solheim et al.	D556,277 S	11/2007	Broom
6,007,434 A	12/1999	Baker et al.	7,309,297 B1	12/2007	Solari
D421,473 S	3/2000	Solheim et al.	D561,854 S	2/2008	Morris
D422,655 S	4/2000	Hicks	7,331,876 B2	2/2008	Klein
6,050,903 A	4/2000	Lake	D565,137 S	3/2008	Oldknow et al.
D426,276 S	6/2000	Besnard et al.	7,351,162 B2	4/2008	Soracco et al.
6,089,993 A	7/2000	Woodward et al.	D569,461 S	5/2008	Morris
D429,302 S	8/2000	Antonious	D569,930 S	5/2008	Nehrbas
6,110,057 A	8/2000	McKinnon	7,396,289 B2	7/2008	Soracco et al.
D430,914 S	9/2000	Antonious	D577,085 S	9/2008	Nicolette et al.
D431,853 S	10/2000	Antonious	D577,086 S	9/2008	Nicolette et al.
D431,854 S	10/2000	Cameron	D579,506 S	10/2008	Nicolette et al.
D432,192 S	10/2000	Hicks	D579,995 S	11/2008	Nicolette et al.
D436,151 S	1/2001	Nicolette et al.	D582,497 S	12/2008	Rollinson
D437,374 S	2/2001	Cameron	7,473,189 B2	1/2009	Schweigert et al.
D441,820 S	5/2001	Nicolette et al.	7,491,131 B2	2/2009	Vinton
D443,668 S	6/2001	Nicolette et al.	D594,921 S	6/2009	Bettinardi
D443,905 S	6/2001	Nicolette et al.	D595,370 S	6/2009	Ines et al.
D444,833 S	7/2001	Wells et al.	D595,793 S	7/2009	Rollinson
D444,835 S	7/2001	Wahl et al.	D599,425 S	9/2009	Laub
			D599,867 S	9/2009	Teramoto
			D600,295 S	9/2009	Meeks
			D600,762 S	9/2009	Serrano et al.
			D600,763 S	9/2009	Cameron
			D601,214 S	9/2009	Serrano et al.
			D606,139 S	12/2009	Ines et al.
			D606,140 S	12/2009	Ramsauer
			D606,141 S	12/2009	Ramsauer
			D606,142 S	12/2009	Ramsauer
			D607,951 S	1/2010	Teramoto
			D607,952 S	1/2010	Demkowski et al.
			D617,857 S	6/2010	Sones

(56)

References Cited

U.S. PATENT DOCUMENTS

7,744,485 B2 6/2010 Jones et al.
 D620,993 S 8/2010 Laub
 D621,461 S 8/2010 Serrano et al.
 D623,709 S 9/2010 Serrano et al.
 D631,925 S 2/2011 Broom
 7,887,432 B2 2/2011 Jones et al.
 D633,964 S 3/2011 Teramoto
 7,909,707 B2 3/2011 Klein
 7,918,745 B2 4/2011 Morris et al.
 7,927,226 B1 4/2011 Twitty
 D638,891 S 5/2011 Nicolette et al.
 7,942,758 B2 5/2011 Nakamura
 D639,369 S 6/2011 Miyamichi
 D642,643 S 8/2011 Nicolette et al.
 D643,485 S 8/2011 Nicolette et al.
 D643,892 S 8/2011 McGrorty
 D645,104 S 9/2011 Nicolette et al.
 8,096,039 B2 1/2012 Soracco et al.
 D653,718 S 2/2012 Stokke et al.
 8,109,841 B2 2/2012 Miyamichi
 D655,361 S 3/2012 Ramsauer
 D661,753 S 6/2012 Cameron et al.
 D666,260 S 8/2012 Cynn
 D672,418 S 12/2012 Rollinson
 8,328,654 B2 12/2012 Demkowski et al.
 8,371,958 B2 2/2013 Treadwell
 8,376,878 B2 2/2013 Bennett et al.
 D688,339 S 8/2013 Hilton et al.
 D688,341 S 8/2013 Rollinson
 D691,226 S 10/2013 Hilton et al.
 D699,308 S 2/2014 Rollinson
 8,696,492 B1 4/2014 Hocknell et al.
 D704,782 S 5/2014 Rollinson
 8,721,472 B2 5/2014 Kuan et al.
 8,790,193 B2 7/2014 Serrano et al.
 D711,483 S 8/2014 Wong
 D715,388 S 10/2014 Serrano et al.
 D722,350 S 2/2015 Schweigert
 D722,351 S 2/2015 Parsons et al.
 D722,352 S 2/2015 Nicolette et al.
 D723,120 S 2/2015 Nicolette
 D724,164 S 3/2015 Schweigert et al.
 D725,208 S 3/2015 Schweigert
 D726,265 S 4/2015 Nicolette
 D726,846 S 4/2015 Schweigert
 D730,462 S 5/2015 Becktor et al.
 D732,122 S 6/2015 Becktor
 D732,618 S 6/2015 Becktor et al.
 D733,234 S 6/2015 Nicolette
 D735,283 S 7/2015 Solheim et al.
 9,108,088 B2 8/2015 Serrano et al.
 D738,447 S 9/2015 Schweigert
 D738,449 S 9/2015 Schweigert
 D739,487 S 9/2015 Schweigert
 D741,426 S 10/2015 Schweigert
 D746,926 S 1/2016 Parsons et al.
 D748,213 S 1/2016 Parsons et al.
 D748,215 S 1/2016 Parsons et al.
 9,233,283 B2 1/2016 Schweigert
 9,265,996 B1 2/2016 Abbott et al.
 D752,697 S 3/2016 Claveran
 D753,252 S 4/2016 Schweigert
 9,440,124 B2 9/2016 Parsons et al.
 9,498,685 B2 11/2016 Abbott et al.
 9,566,484 B1 2/2017 Abbott et al.
 D783,745 S * 4/2017 Chen D21/743
 D791,254 S 7/2017 Ramsauer
 D791,891 S 7/2017 Davis
 D794,146 S 8/2017 Davis

D798,975 S 10/2017 Becktor
 D798,976 S 10/2017 Becktor
 D798,977 S 10/2017 Becktor
 D798,978 S 10/2017 Becktor
 D798,979 S 10/2017 Becktor
 D798,980 S 10/2017 Becktor
 D798,981 S 10/2017 Becktor et al.
 D799,619 S 10/2017 Becktor et al.
 D802,073 S 11/2017 Toulon
 D809,616 S 2/2018 Toulon et al.
 D812,163 S 3/2018 Kroloff
 9,987,530 B2 6/2018 Jertson et al.
 D824,462 S 7/2018 Bruschi et al.
 D827,742 S 9/2018 Weaver
 D835,217 S * 12/2018 Nicolette D21/736
 D837,911 S 1/2019 Bruschi et al.
 10,173,105 B2 1/2019 Myers et al.
 D839,977 S 2/2019 Rollinson et al.
 D844,085 S * 3/2019 Nicolette D21/743
 D844,723 S * 4/2019 Nicolette D21/743
 D859,545 S 9/2019 Long et al.
 D861,091 S 9/2019 Glorioso et al.
 D877,831 S * 3/2020 Cameron D21/736
 D892,243 S 8/2020 Rollinson et al.
 D895,037 S * 9/2020 Clarke D21/736
 D896,328 S 9/2020 Clarke et al.
 D907,730 S * 1/2021 Rollinson D21/759
 D909,504 S * 2/2021 Schweigert D21/736
 D919,722 S * 5/2021 Parsons D21/736
 D931,962 S * 9/2021 Wang D21/743
 D944,348 S * 2/2022 Kim D21/743
 D945,542 S * 3/2022 Andrews D21/736
 2004/0138003 A1 7/2004 Grace
 2004/0180730 A1 9/2004 Franklin et al.
 2006/0052178 A1 3/2006 Franklin et al.
 2006/0094522 A1 5/2006 Tang et al.
 2006/0223649 A1 10/2006 Rife
 2007/0129163 A1 6/2007 Solari
 2007/0135229 A1 6/2007 Lo et al.
 2007/0142122 A1 6/2007 Bonneau
 2007/0207875 A1 9/2007 Kuan et al.
 2007/0238548 A1 10/2007 Johnson
 2008/0139333 A1 6/2008 Klein
 2008/0146372 A1 6/2008 John
 2008/0176672 A1 7/2008 Roach et al.
 2009/0029800 A1 1/2009 Jones et al.
 2010/0255922 A1 10/2010 Lueders
 2011/0165959 A1 7/2011 Klein
 2013/0165256 A1 6/2013 Stevenson
 2013/0210537 A1 8/2013 Ainscough et al.
 2015/0057100 A1 2/2015 Serrano et al.
 2015/0258390 A1 9/2015 DeFrancesco, Jr.
 2015/0306477 A1 10/2015 Parsons et al.
 2016/0016050 A1 1/2016 Rife
 2016/0346649 A1 12/2016 Jertson et al.
 2018/0001163 A1 1/2018 Becktor et al.
 2018/0311545 A1 11/2018 Lambeth et al.

FOREIGN PATENT DOCUMENTS

KR 20100065481 A 6/2010
 KR 101773069 B1 8/2017

OTHER PUBLICATIONS

TourSpecGolf (Gold's Factory Multi Weighted Custom Putter), Published Nov. 20, 2010 [http://blog.toursecgolf.com/golds-factory-multi-weighted-custom-putter/]. Retrieved May 17, 2020.
 U.S. Appl. No. 29/523,587, Schweigert, "Golf Club Head," filed Apr. 10, 2015.

* cited by examiner

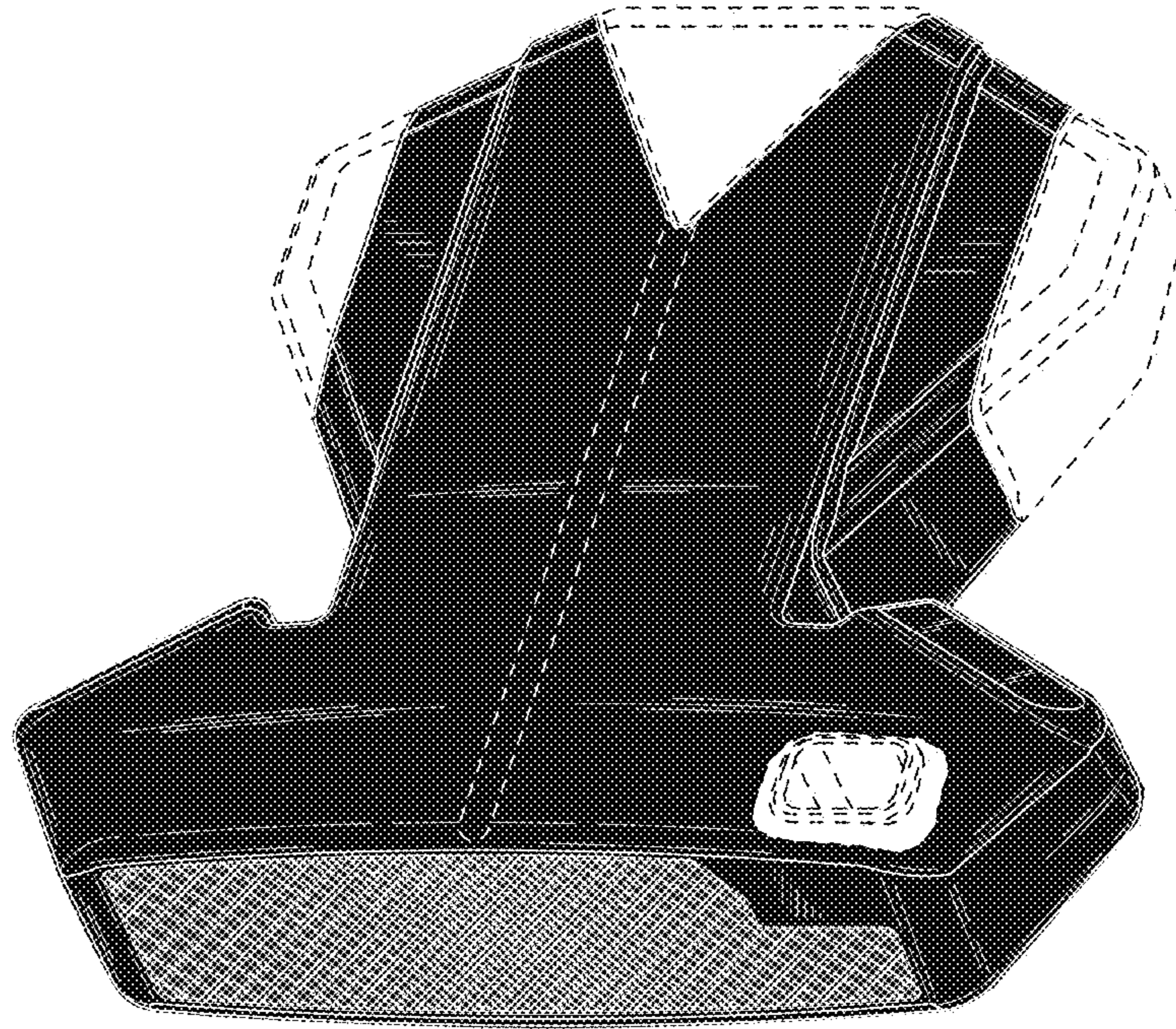

FIG. 1

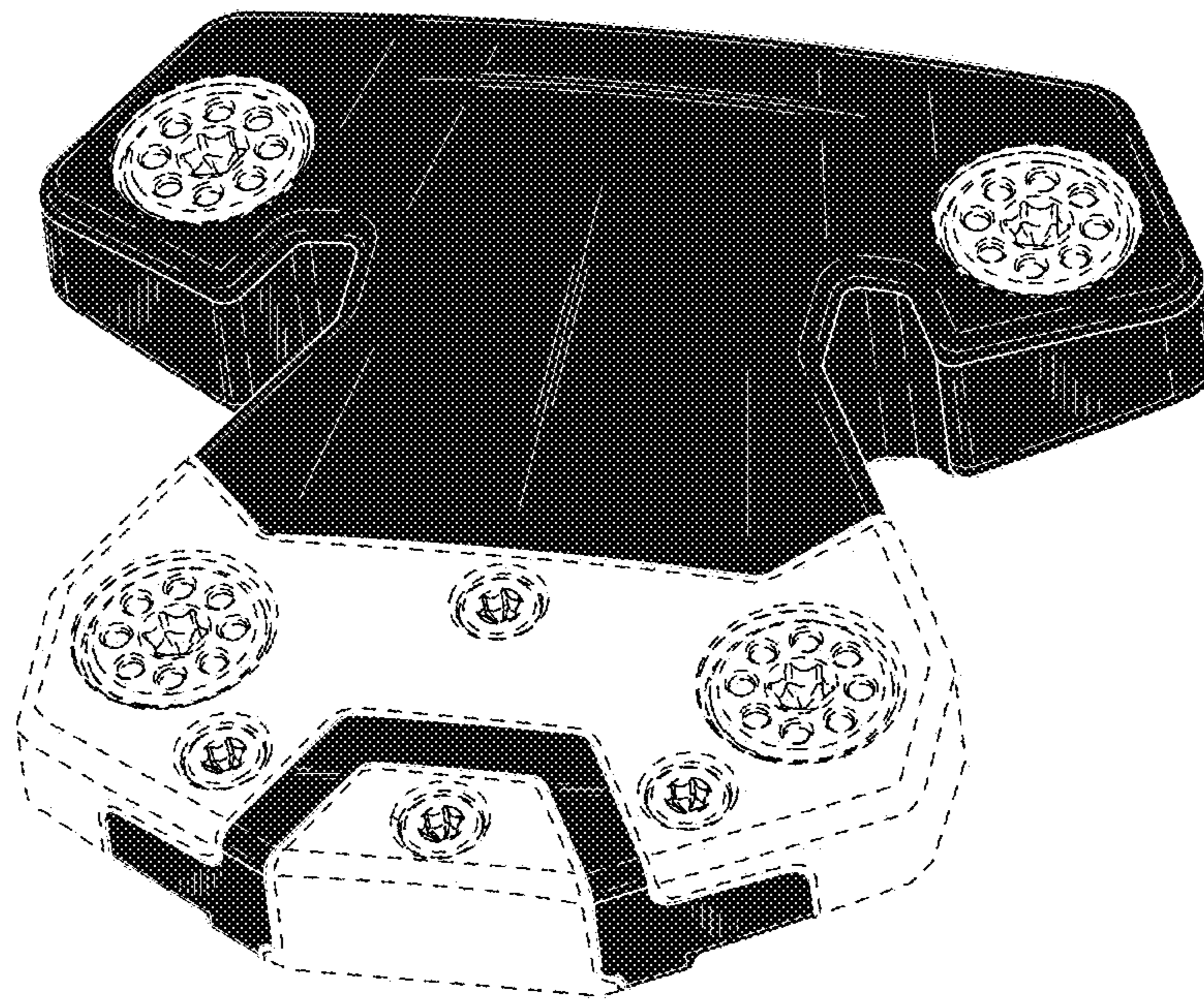

FIG. 2

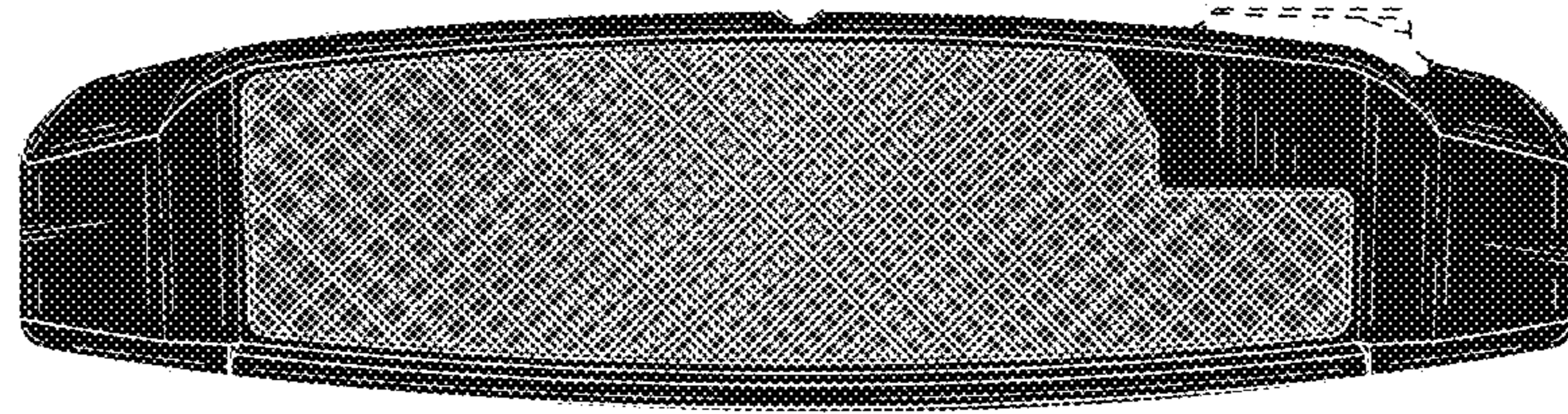

FIG. 3

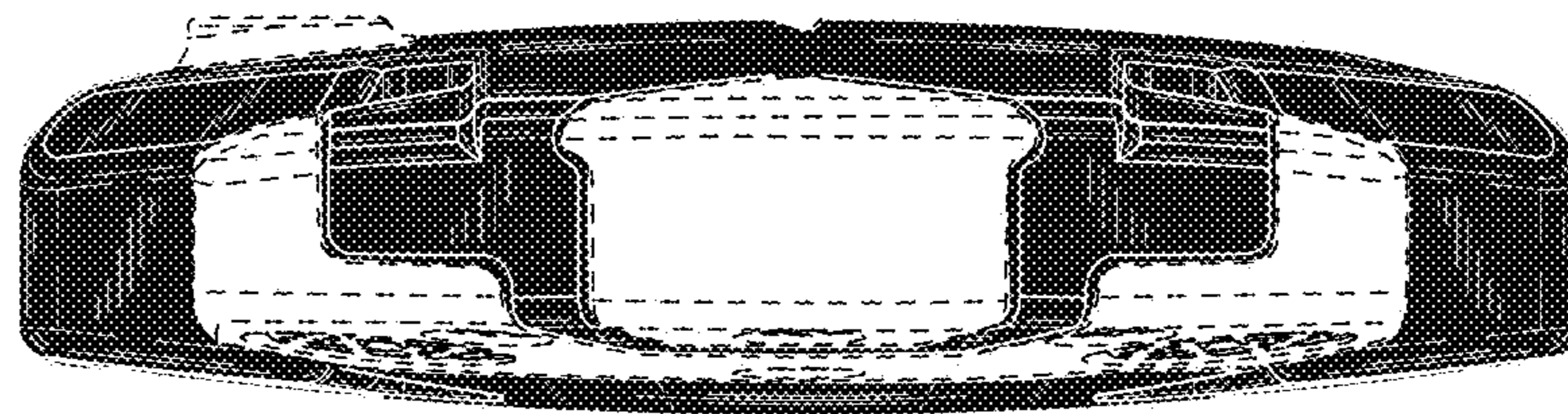

FIG. 4



FIG. 5

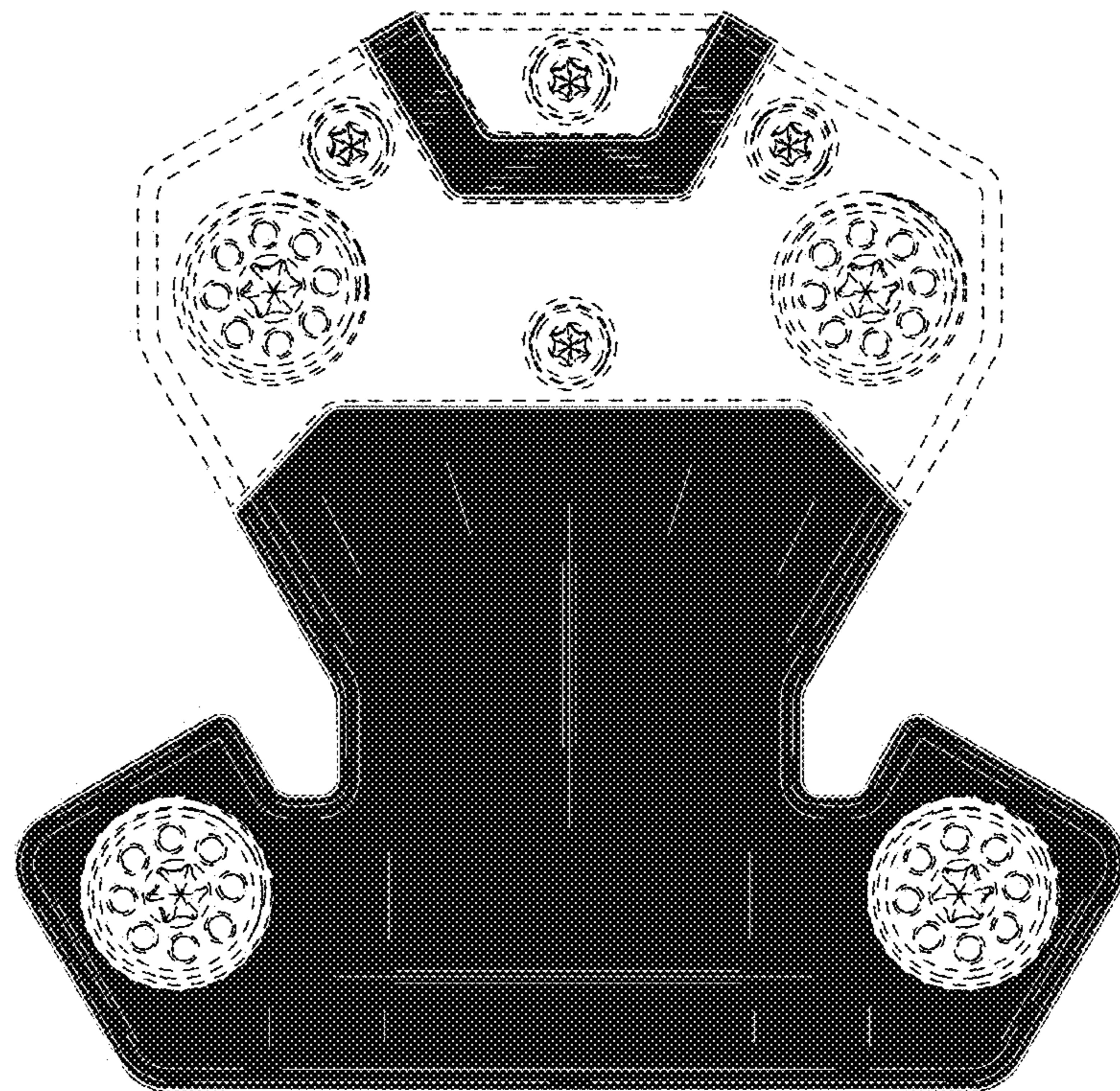

FIG. 6

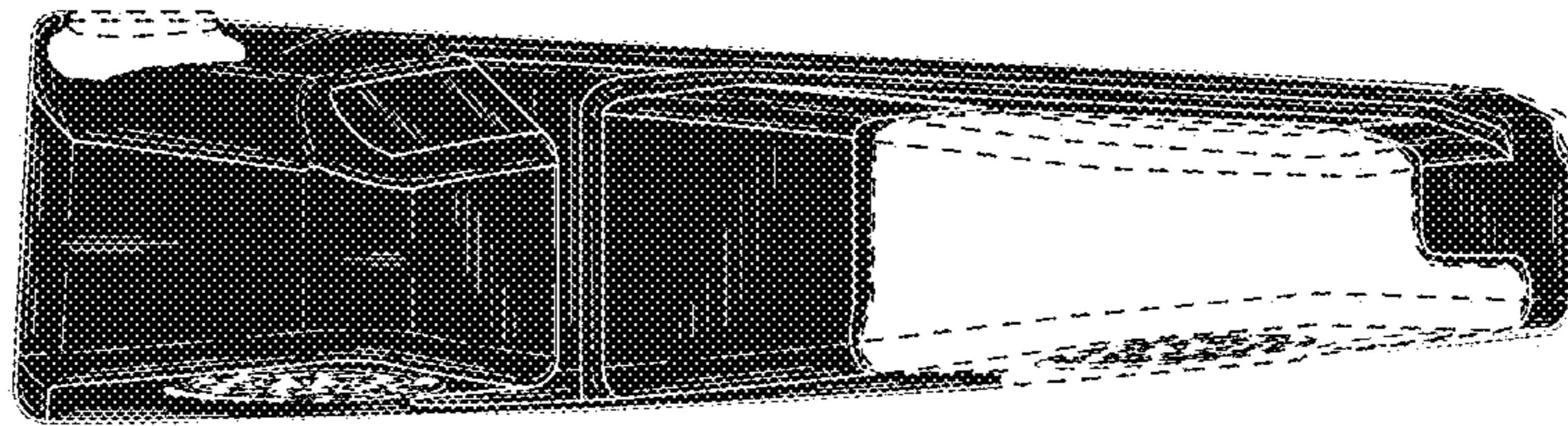

FIG. 7

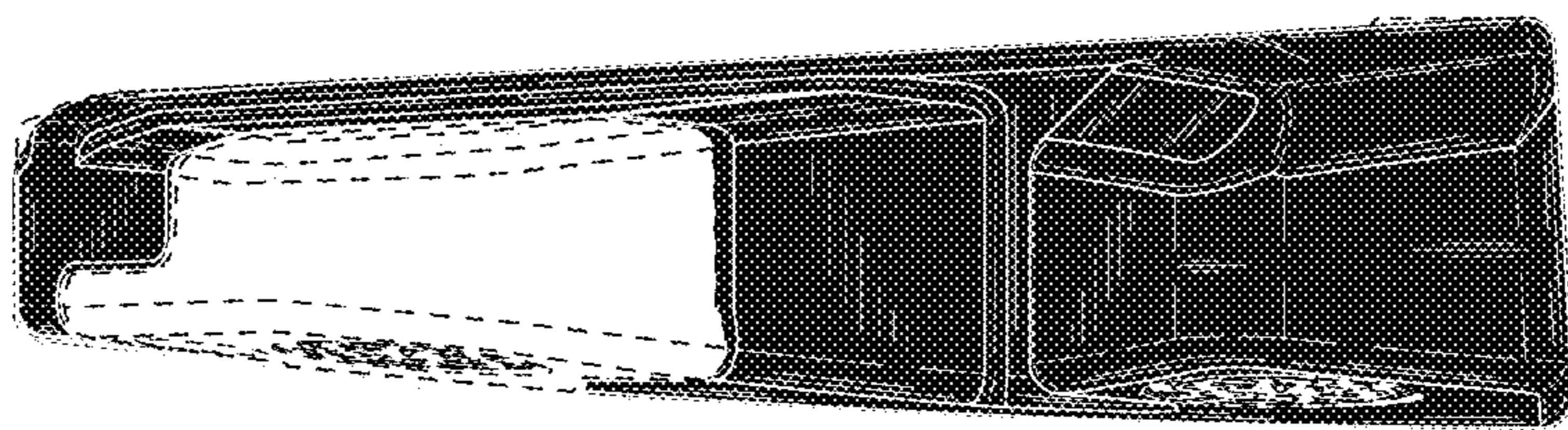

FIG. 8